

THE
RADIO

handbook



The foremost and
most authoritative
text and reference
work on

**Construction
Equipment
Operation
Theory**

of high-frequency
and ultra-high-
frequency radio

ANOTHER PUBLICATION
BY THE
EDITORS OF
RADIO

ONE DOLLAR, FIFTY CENTS

in continental U. S. A.

Elsewhere, \$1.65 or 7s

The "Radio" Handbook



☆ **OTHER PUBLICATIONS**

by the Editors of "Radio"

"Radio"

Radio Digest

"Radio" Antenna Handbook

"Radio" Telephony Handbook

"Radio" Amateur Newcomer

"Radio" Noise Reduction Handbook

"Radio" Ultra-High-Frequency Handbook

[SEE PAGE 499 FOR DETAILS.]

The "Radio" Handbook

By

The Editors of "Radio"

W. W. SMITH

EDITOR-IN-CHIEF

Frank C. Jones

Ray L. Dawley

E. H. Conklin

M. M. Lloyd

R. P. Turner

K. V. R. Lansingh

B. A. Ontiveros



FIFTH
EDITION



PUBLISHERS—DISTRIBUTORS

RADIO, LTD., 7460 BEVERLY BLVD., LOS ANGELES, CALIF., U.S.A.

First Printing
OCTOBER, 1938



COPYRIGHT, 1938

by Radio, Ltd., 7460 Beverly Blvd., Los Angeles.
Copyright secured under Pan-American Convention.
All translation rights reserved.

The Radio Handbook



TABLE OF CONTENTS

Foreword	6
Chapter 1. Fundamental Theory	7
Chapter 2. Vacuum Tubes	40
Chapter 3. Decibels and Logarithms	52
Chapter 4. Antennas	60
Chapter 5. In the Workshop	129
Chapter 6. Learning the Code	142
Chapter 7. Radio Receiver Theory	149
Chapter 8. Radio Receiver Construction	171
Chapter 9. Receiver Tube Characteristics	213
Chapter 10. Transmitting Tubes	229
Chapter 11. Transmitter Theory	263
Chapter 12. Exciter Construction	296
Chapter 13. C. W. Transmitter Construction	327
Chapter 14. Radiotelephony Theory	344
Chapter 15. Radiophone Transmitter Construction	372
Chapter 16. U.H.F. Communication	409
Chapter 17. Power Supplies	439
Chapter 18. Test Equipment	460
Chapter 19. Radio Therapy	484
Chapter 20. Radio Laws	491
Appendix—Buyer's Guide—Index	

Written by



THE EDITORS OF "RADIO"



The "Radio" Handbook

FOREWORD

THE Editors of RADIO have unquestionably become in recent years the outstanding group in radio not affiliated with a definite commercial interest. They are all practical radio engineers and active amateurs of many years' experience. They are the source of the reputation and prestige of RADIO, envied by publications of greater circulation.

Starting several years ago with an extensive set of "notes" compiled for their own use, the Editors of RADIO and particularly Frank C. Jones have developed the present "RADIO" HANDBOOK, which is now in its fifth edition. Each edition is thoroughly revised, not merely brought up to date. To keep up with rapid developments in commercial equipment, the great majority of items shown in the constructional pages are newly built for each edition. Though a few outstanding items were selected from other publications by the same publishers, the greater portion are built especially for this handbook. All have been tried in actual practice.

New methods have been evolved for the presentation of buffers and amplifiers. By means of them, the reader will be able to select the oscillator, buffer, and doubler or final amplifier which he prefers, regardless of the type of tube he has or wishes to use. This will permit the design of a transmitter employing one of several suitable combinations of the respective units. It is not necessary to adhere to one complete set of instructions in planning a transmitter. But for those who so desire, several completely-built transmitters are described.

Taken all in all, no effort has been spared in an attempt to compile the most comprehensive book on the subject, both as a reference for those with wide knowledge of the field and as a practical text for those of limited knowledge and means.

In closing, we wish to thank those whose year-after-year purchases have indicated their approval of such an unusual policy. This policy has only been possible, however, with the additional cooperation of our advertisers. In similar technical fields texts such as this sell from \$5.00 upwards; whatever value this book may have for you over its purchase price is a gift to you from our advertisers. We hope that you will reciprocate by using their products when suited to the job at hand.

THE PUBLISHERS

LOS ANGELES, CALIFORNIA

October, 1938

The Editors of RADIO in preparing this work have not only drawn upon their own knowledge and extensive experience, but also have drawn upon nearly the whole current field of radio literature, wherefore it is impossible to give due acknowledgment to all whose work has been consulted to some extent. We wish to acknowledge particularly the kind permission of the RCA Manufacturing Co., Inc., to use certain of the formulas in the theoretical pages, as well as extensive data and specifications on vacuum tubes.

CHAPTER I

Fundamental Theory

Elementary Electricity and Radio Physics — Circuit Characteristics and Components — Computations

OUR ENTIRE world — in fact, the human being himself—is a combination of approximately ninety-two substances, called *elements*. In spite of this large number of elements, each in turn is composed of two basic units, the positive *proton* and the negative *electron*. The difference between iron and copper, for example, lies not in the basic units of which they are composed, but rather in the *quantity* and the *position* of these units.

Electrons and protons in combination are known as *atoms*. The proton (one or more) represents the central or nuclear *positive charge*, while the electron (or electrons) represents the outer or *negative charge*. These electrons revolve around the central unit in an elliptical path or orbit in much the same manner as the planets in our solar system revolve about the sun. The atoms which make up the various elements differ mainly in the fact that some have several rings of electrons, rather than a single ring.

The electrons in the orbits which surround the positive nucleus have a charge that is exactly equal to the central unit, and, since they are opposite in *polarity*, a perfect state of balance exists. It is this same general state of balance which exists throughout nature, generally speaking.

It is important to understand that an atom (or atoms) containing several orbits of electrons around the central portion (nucleus) will have many of its electrons at a considerable distance from the nucleus, and consequently these electrons will not be so strongly held as those in the nearer orbits.

In relative size the proton is considered

to be approximately 1,845 times larger than the electron. Any attempt to visualize the actual physical mass of either is quite impossible, the realization becoming evident when it is considered that countless billions upon billions of electrons and protons make up a tiny piece of copper wire.

When this enormous quantity of atoms in any particular object is taken into consideration, it is easier to understand why, when electrons in some far-removed orbit are not so strongly held by their central positive proton, such electrons are very apt to be attracted by some other atom which has previously lost its outer electron. This is exactly what happens.

The atom at all times seeks to maintain a state of balance; this is accomplished only when an atom has the proper number of electrons. If one electron is lost to some other atom, balance is quickly restored by attracting another. Consequently, there is a continuous helter-skelter movement of electrons, a constant shifting from one atom to another. The electrons which move about in a substance are called *free electrons*, and it is these free electrons that make possible the *electric current*.

Conductors and Insulators

Should the atomic structure of a certain material be such that all of the electrons in an individual atom are tightly held by their positive proton and tend to remain within their own orbits, the material or substance will have very few free electrons and becomes what is known as an *insulator*. Mica, glass, porcelain and dry air are examples of such insulators.

On the other hand, materials that have a large number of free electrons are known as *conductors*. Most metals, such as copper, silver and aluminum, are conductors. The ability of a material to pass an electric current is known as its *conductivity*. Metals which have high conductivity may be said to have low *resistance* to the flow of an electric current.

The Electric Current

The free electrons in a conductor move constantly about and change their position in a haphazard manner. If, however, the conductor is connected between the positive and negative terminals of a battery, there will be a steady movement of electrons from the negative to positive terminal, in *addition* to the irregular movement of the electrons. This flow constitutes an *electric current*, but as soon as the battery is removed, the current will cease.

It can be said in explanation that when the battery was first connected to the wire, there existed a shortage of electrons at one terminal which the electrons at the other terminal attempted to supply.

Remember that the constant *movement* of electrons in a definite direction creates an electric current. In the previous example, the constant electron movement was brought to a halt when the battery was disconnected since the surplus electrons immediately supplied the deficiency existing at one end and established a balance throughout the entire conductor.

Resistance

The molecular structure of certain metals is such that when the free electrons are made to flow in a definite direction, there are frequent collisions between them and the individual atoms in the material. The result of these collisions is to *decrease* the total electron flow. This ability of a substance to resist the steady electron flow is called its *resistance*.

It will require a greater *electromotive force* to produce a given current through a substance with high resistance than to produce the same current in a good conductor. In the case of the conductor virtually all of the electromotive force is effective in producing current, whereas in the resistor a portion is wasted

in the form of lost energy due to electron collisions. These collisions cause the material to become heated, and part of the initially-applied electromotive force is thus ultimately lost in the form of heat. This same phenomenon of heat is exhibited when a metal is repeatedly struck by a hammer.

The resistance of a uniform length of material is directly proportional to its length and inversely proportional to its cross section. A wire with a certain resistance for a given length will have twice as much resistance if the length of the wire is doubled.

For a given length, doubling the size (cross section) of the wire will *halve* the resistance. It is also important to note that the resistance of most materials will increase as the temperature is increased. Thus, the resistance of the filament in a vacuum tube, or in a tungsten electric lamp, is many times higher when brought to operating temperature than when it is cold.

The resistance of a material or circuit can be expressed by a constant, *R*, which is equal to the ratio of the applied electromotive force to the current produced. Expressed as an equation:

$$R = \frac{\text{electromotive force}}{\text{current}}$$

This equation constitutes the basis for *Ohm's Law*, which is treated at length in the succeeding text.

The commonly-used unit of resistance is the *ohm* although the expression *megohm* (1,000,000 ohms) is sometimes used when very large quantities are involved.

The Ampere

The *strength* of an electric current depends upon the rate at which electrons pass a given point. The units of measurement are the *ampere* and the *coulomb*, one ampere being equal to 6.28×10^{18} electrons passing a given point in one second. The generally-used term in electrical practice is the *ampere*, in which the time element is already implied and need not be stated, as would be the case when referring to current in terms of coulombs (coulombs per second).

The Volt

The electrons are driven through the wires and components of a circuit by a

force called an *electromotive force*, usually abbreviated *e.m.f.* or *E.M.F.* The unit that denotes this force is called the *volt*. This force or pressure is measured in terms of the difference in the number of electrons at one point with respect to another. This is known as the *potential difference*.

The relationship between the electromotive force (voltage) to the flow of current (amperes), and the resistance which impedes the flow of current (ohms), is very clearly expressed in a simple but highly valuable law known as *Ohm's law*.

Ohm's Law

This law states that the current in amperes is equal to the voltage divided by the resistance in ohms. Expressed as an equation:

$$I = \frac{E}{R}$$

If the voltage (E) and resistance (R) are known, the current (I) can be readily found. If the voltage and current are known, and the resistance is unknown, the resistance (R) is equal to

$$R = \frac{E}{I}$$

When the voltage is the unknown quantity, it can be found by multiplying $I \times R$. These three equations are all secured from the original by simple transposition. The expressions are here repeated for quick reference:

$$I = \frac{E}{R} \quad R = \frac{E}{I} \quad E = IR$$

where *I* is the current in amperes,
R is the resistance in ohms,
E is the electromotive force in volts

One typical problem for the application of Ohm's law would be a resistance-coupled amplifier whose plate resistor has a value of 50,000 ohms, with a measured current through this resistor of 5 milliamperes. The problem is to find the actual voltage applied to the plate of the tube.

The resistance R is 50,000 ohms. The current I is given as 5 milliamperes; milliamperes must, therefore, first be converted into amperes; .005 amperes equals 5 milliamperes. The electromotive force or voltage, E, is the unknown quantity. Ohm's law is applied as follows:

Formula: $E = I \times R$
 $R = 50,000$ ohms
 $I = .005$ amperes

Solution: $.005 \times 50,000 = 250$ volts drop across the resistor.

If the power supply delivers 300 volts, the actual voltage on the plate of the tube would be only 50 volts. This means that 250 volts of the supply voltage would be consumed in forcing a current of .005 amperes through the 50,000-ohm plate resistor.

Example (2)

Given the same amplifier, suppose it is desirable in this case to have a voltage of 150 on the plate of the tube. The known quantities are a plate current of 10 milliamperes (0.01 amperes) and a supply voltage of 300 volts. It is desired to find the value of plate resistor to provide this drop in voltage.

From the foregoing, it is obvious that with 300-volts plate supply available, the voltage that must be consumed across the plate resistor is 150 volts, so that 150 volts will remain at the plate of the tube. The problem is solved as follows:

From Ohm's law, $R = \frac{E}{I}$

E in the above example is equal to the *difference* between supply and desired voltages, or the "voltage drop" across the resistor, R.

Therefore:

$$R = \frac{150}{0.010}, \text{ or } 15,000 \text{ ohms.}$$

Example (3)

The given supply voltage is 300, and the (measured) voltage on the plate of the tube is 100 volts. Find the current flowing through the plate resistor of 20,000 ohms.

From Ohm's law, $I = \frac{E}{R}$, E again

equals the *difference* between supply and measured plate voltages.

Therefore:

$$I = \frac{200}{20,000},$$

$I = 0.010$ amperes, or 10 milliamperes.

Resistances in Series

The *total* resistance of several resistances in series is equal to the sum total of the individual resistances. A 50,000-ohm resistance in *series* with a 25,000-ohm resistance would give a total resistance of 75,000 ohms.

$$\text{Formula: } R_1 + R_2 = R_3$$

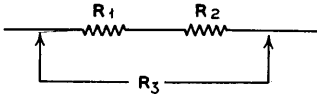

FIGURE 1.

Resistances in Parallel

When *two* resistances of *equal* value are connected in *parallel*, the total resistance will be one half the resistance of one. Two 100,000-ohm resistances connected in parallel would have a total resistance of only 50,000 ohms.

When two or more resistances are connected in parallel, the effective total is always *less* than the value of the lowest resistance in the group. The value of three or more *unequal* resistances in parallel is solved from the following formula:

$$R = \frac{1}{\frac{1}{R_1} + \frac{1}{R_2} + \frac{1}{R_3}}$$

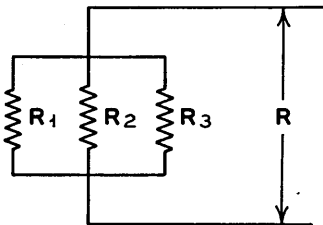

FIGURE 2.

Three or More Parallel Resistors Having Same Value

When three or more resistors of the *same value* are connected in parallel, the effective resistance is the common value divided by the number of resistances connected in parallel.

Examples:

Three resistances of 75,000 ohms each, connected in parallel, would have an effective resistance of $\frac{75,000}{3}$ or only

25,000 ohms.

Four resistances of 200 ohms each, connected in parallel, would have an effective resistance of $\frac{200}{4}$, or only 50

ohms.

Two Unlike Resistances In Parallel

When two resistances have the *same* value, the above formula applies. When the resistances are of *unequal* values, the following formula is used:

$$R = \frac{R_1 \times R_2}{R_1 + R_2},$$

where *R* is the unknown quantity,

*R*₁ is the resistance of the first resistor,

*R*₂ is the resistance of the second resistor.

A typical example would be an a.v.c. resistor of 500,000 ohms, which is to be shunted (paralleled) with another resistor of some value, in order to bring the *effective* resistance value *down* to a value of 300,000 ohms. Substituting these values in the equation for two unequal resistances in parallel:

$$300,000 = \frac{500,000 \times R_2}{500,000 + R_2}$$

By transposition, factoring and solution, the effective value of *R* will be 750,000 ohms. Thus a 750,000-ohm resistance must be connected across the 500,000-ohm resistance in order to secure an effective resistance of 300,000 ohms.

In solving for values other than those given, the simplified equation becomes:

$$R_2 = \frac{R_1 \times R}{R - R_1},$$

where *R* is the resistance present,

*R*₁ is the resistance to be obtained,

*R*₂ is the value of the unknown resistance necessary to give *R*₁ when in parallel with *R*.

Resistances in Series-Parallel

Resistances in series-parallel can be solved from the equation:

$$R = \frac{1}{\frac{1}{R_1 + R_2} + \frac{1}{R_3 + R_4} + \frac{1}{R_5 + R_6}}$$

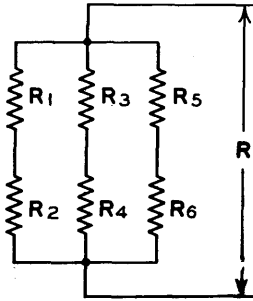

FIGURE 3.

Power Measurements and Formulas for Resistive Circuits

When a voltage causes a given current to flow through a resistor, heat is generated or dissipated by the resistor. This loss is attributable to the molecular structure of the material through which the current is made to pass. In other words, if the constant flow of electrons is always coming into contact with the atoms of the material through which the electrons flow, there will be countless collisions and the electrons must, therefore, be forced through in order that a given number will constantly move through the conducting medium. This phenomenon results in heating of the conductor, and this heating results in a loss of *power or energy*.

From Ohm's law, $E = I \times R$, it can readily be seen that if the resistance of a circuit is doubled, it will require twice the voltage to maintain the same current flow through the added resistance. This expenditure of power can be considered as the product of the voltage and current in the circuit and is expressed in *watts*. Hence, W (watts) = $E \times I$. Since it is very convenient to express power in terms of the resistance and current, a substitution of $I \times R$ for E ($E = I \times$

R) in the above formula, gives: $W = IR \times I$, or I^2R .

In terms of voltage and resistance, $W = \frac{E^2}{R}$. Here, $I = \frac{E}{R}$ and, when this was substituted for I , the formula became $W = E \times \frac{E}{R}$ or $W = \frac{E^2}{R}$. These three expressions are repeated for quick reference:

$$W = E \times I, \quad W = I^2 \times R, \quad W = \frac{E^2}{R}$$

where W is the power in watts,
 E is the electromotive force or voltage,
 I is the current in amperes.

This equation is used in the following typical example: The voltage drop across a cathode resistor in a power amplifier stage is 50 volts; the plate current flowing through the resistor is 150 milliamperes. The number of watts the resistor will be required to dissipate is found from the formula: W (watts) = $E \times I$, or $50 \times .150 = 7.5$ watts (.150 amperes is equal to 150 milliamperes). From the foregoing it is seen that a 7.5-watt resistor will safely carry the required current, yet a 10- or 20-watt resistor would ordinarily be used to provide a safety factor.

In another problem, the conditions being similar to those above, but with resistance and current being the *known* factors, the solution is obtained as follows: $W = I^2 \times R = .0225 \times 333.33 = 7.5$.

If only the voltage and resistance are known, $W = \frac{E^2}{R} = \frac{2500}{333.33} = 7.5$ watts.

It is seen that all three equations give the same result; the selection of the particular equation depends only upon the known factors.

Voltage Dividers

A voltage divider is exactly what its name implies: a resistor or a series of resistors connected across a source of voltage from which various lesser values of voltage may be obtained by connection to various points along the resistor.

A voltage divider serves a most useful purpose in a radio receiver, transmitter or amplifier, because it offers a simple

means of obtaining plate, screen and bias voltages of different values from a common power supply source. It may also be used to obtain very low voltages of the order of .01 to .001 volts with a high degree of accuracy, even though a means of measuring such voltages is lacking. The procedure for making these measurements can best be given in the following example:

Assume that an accurately calibrated 0-150 voltmeter is available and that the source of voltage is exactly 100 volts. This 100 volts is then impressed through a resistance of exactly 1,000 ohms. It will, then, be found that the voltage

along various points on the resistor, with respect to the grounded end, will be exactly proportional to the resistance at that point. From Ohm's law, the current would be 0.1 ampere; this current remains unchanged since the original value of resistance (1,000 ohms) and the voltage source (100 volts) are unchanged. Thus, at a 500-ohm point on the resistor (half its entire resistance), the voltage will likewise be halved or reduced to 50 volts.

The equation ($E = I \times R$) gives the proof: $E = 500 \times 0.1 = 50$. At the point of 250 ohms on the resistor, the voltage will be one-fourth the total value or 25 volts ($E = 250 \times 0.1 = 25$). Continuing with this process, a point can be found where the resistance measures exactly one ohm and where the voltage equals 0.1 volt. It is, therefore, obvious that if the original source of voltage and resistance can be measured, it is a simple matter to predetermine the voltage at any point along the resistor, provided that the current remains constant.

Conversion Table for Volts, Amperes and Watts.

- 1 kilovolt = 1,000 volts.
- 1 volt = 1/1000 kilovolt, 10^{-3} kilovolts, or .001 kilovolt.
- 1 millivolt = 1/1000 volt, 10^{-3} volts, or .001 volt.
- 1,000 millivolts = 1 volt.
- 1 microvolt = 1/1,000,000 volt, 10^{-6} volts, or .000001 volt.
- 1,000,000 microvolts = 1 volt.
- 1,000 microvolts = 1 millivolt, or 10^{-3} volts.
- 1 milliampere = 1/1,000 ampere, 10^{-3} amperes, or .001 ampere.
- 1,000 milliamperes = 1 ampere.
- 1 microampere = 1/1,000,000 ampere, 10^{-6} amperes, or .000001 ampere.
- 1,000 microamperes = 1 milliampere, or 10^{-3} amperes.
- 1 kilowatt = 1,000 watts.
- 1 watt = 1/1,000 kilowatt, 10^{-3} kilowatts, or .001 kilowatt.
- 1 milliwatt = 1/1,000 of a watt, 10^{-3} watts, or .001 watts.
- 1,000 milliwatts = 1 watt.
- 1 microwatt = 1/1,000,000 of a watt, 10^{-6} watts, or .000001 watt.
- 1,000 microwatts = 1 milliwatt or 10^{-3} watts.

Bleeder Resistors

Often resistors are connected across the output terminals of power supplies in order to bleed off a constant value of current or to serve as a constant fixed load. The regulation of the power supply is thereby improved and the voltage is maintained at a more or less constant value, regardless of load conditions. When the load is entirely removed from a power supply, the voltage may rise to such a high value as to ruin the filter condensers.

The amount of current which can be drawn from a power supply depends upon the current rating of the particular power transformer in use. If a transformer will carry a maximum safe current of 100 milliamperes, and if 75 milliamperes of this current is required for operation of a radio receiver, there remains 25 milliamperes of current available which can be wasted in the bleeder resistor.

An example for calculating bleeder resistor values for safe wattage rating is as follows: The power supply delivers 300 volts. The power transformer can safely supply 75 milliamperes of current, of which 60 milliamperes will be required for the receiver. The problem is to find the correct value of resistance to

give a bleeder current of 15 milliamperes.

Ohm's law gives the solution: $R = \frac{E}{I}$

$$= \frac{300}{.015} = 20,000 \text{ ohms. (15 milliamperes)}$$

is equivalent to .015 ampere.) Therefore, it is seen that the bleeder resistor should have a resistance of 20,000 ohms.

Another problem would be to find the required safe wattage rating of the bleeder, under the same conditions as given in the previous example. The answer is secured as follows: $W = E \times I = 300 \times .015 = 4.5$ watts. It is considered good practice to allow an overload factor of at least 100 per cent, since the voltage will increase somewhat when all load except the bleeder is removed. Therefore, a 10-watt resistor should be chosen.

Voltage Divider Design

Proper design of a voltage divider for any type of radio equipment is a relatively simple matter. The first consideration is the amount of bleeder current to be drawn, which is dictated largely by the examples previously given. In addition, it is also necessary that the desired voltage and the exact current at each tap on the voltage divider be known.

The current does not flow from the tap-on point through the resistor to ground or negative terminal, but rather from the positive side, then out through the tap, then through the device to ground. This explanation can be more easily followed by referring to figure 4, wherein the arrows indicate the direction of current flow through the external load.

The device which secures current from the voltage divider is indicated as C. The current drawn by C flows through section A of the bleeder resistor, then through C, and back to ground. The bleeder current, however, flows through the entire divider, i.e., through both A and B. Therefore, it becomes apparent that when a tap-on point is chosen to give the voltage desired, it is necessary to consider not only the current drawn by the device C, but also the bleeder current.

The design of more complex voltage dividers can best be illustrated by means of the following problems:

A power supply delivers 300 volts and is conservatively rated to supply all needed current for the receiver and still allow a bleeder current of 10 milliamperes. The following voltages are wanted: 250 volts at 20 milliamperes for the plates of the tubes, 100 volts at 5 milliamperes for the screens of the tubes, and 75 volts at 2 milliamperes for the

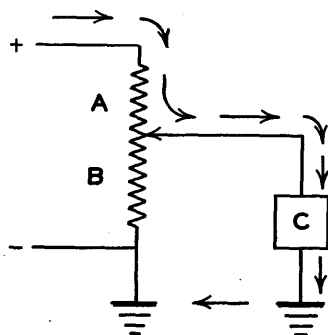

Figure 4. Use of an adjustable voltage divider to feed an external load, C.

the detector tube. The voltage drop from the 300-volt value to the required 250 volts would be 50 volts; for the 100-volt value, the drop will be 150 volts; for the 75-volt value, the drop will be 25 volts. These values are shown in the diagram of figure 5. The respective current values are also indicated.

Tabulating the above:

$$A = \frac{\text{Voltage Drop } 50}{\text{Current } .037} = 1,351 \text{ ohms.}$$

$$\text{Dissipation} = .037 \times 50 = 1.85 \text{ watts.}$$

$$B = \frac{\text{Voltage Drop } 150}{\text{Current } .017} = 8,823 \text{ ohms.}$$

$$\text{Dissipation} = .017 \times 150 = 2.25 \text{ watts.}$$

$$C = \frac{\text{Voltage Drop } 25}{\text{Current } .012} = 2,083 \text{ ohms.}$$

$$\text{Dissipation} = .012 \times 25 = 0.3 \text{ watts.}$$

$$D = \frac{\text{Voltage Drop } 75}{\text{Current } .010} = 7,500 \text{ ohms.}$$

$$\text{Dissipation} = .010 \times 75 = 0.75 \text{ watts.}$$

The divider has a total resistance of 19,757 ohms; this value is secured by adding together the four resistance values of 1,351, 8,823, 2,083 and 7,500 ohms. A 20,000-ohm resistor with three sliding taps will, therefore, be of the approximately correct size and, therefore, would ordinarily be used because of the difficulty in securing four separate resistors of the exact odd values indicated and because no adjustment would be possible to compensate for any slight error in estimating the probable currents through the various taps.

While the wattage dissipation across all the individual sections is only 5.15 watts, the selection of a single resistor, such as a large resistor with several sliders, should be based not only on the wattage rating but also on the current that it will safely carry. In the above example, the wattage of the section carrying the heaviest current is only 1.85 watts. The maximum dissipation of any particular section is 2.25 watts. Yet, if a 5-watt resistor were selected, it would very soon burn up. The reason for this is that *part* of the divider must handle 37 ma.

The selection for wattage rating is, therefore, made on the basis of *current* because wattage rating of resistors assumes uniform current distribution. Most manufacturers rate their resistors in this manner; if not, it can be calculated from the resistance and wattage rating.

When the sliders on the resistor once are set to the proper point, as in the above example, the voltages will remain constant at the values shown as long as the current remains a constant value.

One of the serious disadvantages of the voltage divider becomes evident when the current drawn from one of the taps changes. It is obvious that the voltage drops are interdependent and, in turn, the individual drops are in proportion to the current which flows through the respective sections of the divider resistor. The only remedy lies in providing a heavy steady bleeder current in order to make the individual currents so small a part of the total current that any change in current will result in only a slight change in voltage. This can seldom be realized in practice because of the excessive values of bleeder current which would be required.

When a power supply is used for C-bias service, still another factor must be taken into consideration. The rectified grid current from the amplifier stages will flow through the divider in the same direction as the bleeder current. If this grid current changes, the voltage applied to the grid will also correspondingly change. Adjustments of a C-bias supply should be made while the amplifier draws its proper amount of grid current; otherwise, the C-bias resistor setting will be greatly in error. Heavy bleeder currents are thus required for C-bias supplies, especially where the grid current is changing and the bias must remain constant, as in certain types of phone transmitters.

Resistances for Operating Filaments in Series

Not only do the following problems regarding series and parallel operation of vacuum tube filaments have practical

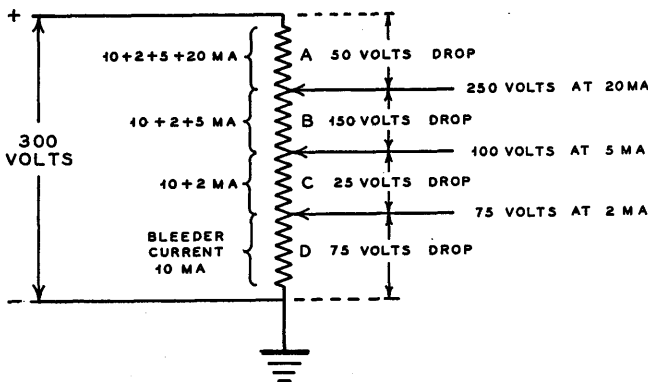

Figure 5. Combined bleeder and adjustable voltage divider resistor as commonly used in radio receivers.

application in the design of radio receivers, but they serve as excellent examples for those who want to follow the solution of typical problems involving calculations of resistance, current, voltage and wattage.

When computations are made for the operation of vacuum tube filaments or heaters in series connection, it should be remembered that each has a definite resistance and that Ohm's law here again holds true, just as it does in the case of a conventional resistance.

No particular problem is involved when two exactly similar tubes of the same voltage and current rating are to be operated with their filaments or heaters connected in series in order to operate them from a source of voltage twice as high as is required for the tubes. If two six-volt tubes, each requiring 0.5 ampere for heater operation, are connected in series across a 12-volt power source, each tube will have the same voltage drop (6 volts), and the total current drawn from the power supply will be the same as for one tube or 0.5 ampere. By making this connection, the resistance has actually been doubled; yet, because the voltage is doubled, each tube automatically secures its proper voltage drop.

In this example, the resistance of each tube would be 12 ohms (6 divided by 0.5). In series, the resistance would be twice this value or 24 ohms. The current I would then equal $\frac{12}{24}$ or 0.5 amperes,

from which it can be seen that the current drawn from the supply is the same as for a single tube.

It is important to understand that in a series connection the sum of the voltage drops across all of the tubes in the circuit cannot be more than the voltage of the supply. It is not possible to connect six similar 6-volt tubes in series across a 32-volt supply and expect to realize 6 volts on the filaments of each, since the sum of the various voltage drops is equal to 36 volts. The tubes can, however, be connected in such a manner that the correct voltage drop will be secured as will be explained later.

The following examples and diagrams give all needed design information for series- and series-parallel connections:

Example—One 6F6 and one 6L6 tube

are to be operated in a low-power airplane transmitter. The power supply delivers 12.6 volts. The problem is to connect the heaters of the two tubes in such a manner that each tube will have exactly the same voltage drop across its heater terminals. The *tube tables* show that a type 6F6 tube draws 0.7 ampere at 6.3 volts. Its resistance, accordingly,

$$\text{equals } R = \frac{E}{I} = \frac{6.3}{0.7} = 9 \text{ ohms.}$$

The 6L6 tube draws 0.9 ampere at 6.3 volts, and its resistance equals $\frac{6.3}{0.9} = 7$ ohms.

If these tubes are connected in series without precautionary measures, the total resistance of the two will be 16 ohms (9 + 7). A potential of 12.6 volts will pass a current of 0.787 ampere through this value of 16 ohms. The drop across each separate resistor is found from Ohm's law, as follows: $9 \times 0.787 = 7.083$ volts, and $7 \times 0.787 = 5.4$ volts. Thus, it is seen that neither tube will have the correct voltage drop.

One of the resistor values must, therefore, be changed so that it will be equal to the other in order that the voltage drop will be equal across both tubes. If the larger of the two resistors is taken and another resistor connected in parallel across it, the value of the larger resistor can then be brought down to that of the smaller.

Substituting these values in an equation previously given, $R = \frac{7 \times 9}{7-9} = 31.5$

6F6 = 9 OHMS

6L6 = 7 OHMS

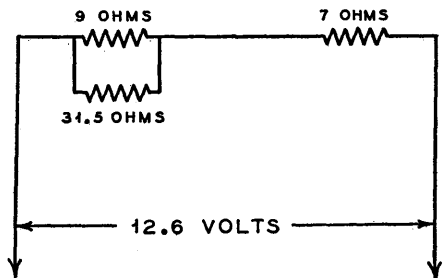

FIGURE 6.

ohms. By connecting a resistance of 31.5 ohms in parallel with the 9-ohm resistance, the effective resistance will be exactly 7 ohms or equal to that of the other resistor.

The problem is made more simple by the following procedure:

If the tubes are regarded on the basis of their respective current ratings, it will be found that the 6L6 draws 0.9 ampere and the 6F6 0.7 ampere, or a difference of 0.2 ampere. If the resistance of the 6F6 is made equal to that of the 6L6, both tubes will draw the same current. Simply take the difference in current, 0.2 ampere, and divide this value into the proper voltage drop, 6.3 volts; the answer will be 31.5 ohms, which is the exact same value obtained in the previous roundabout method of calculation.

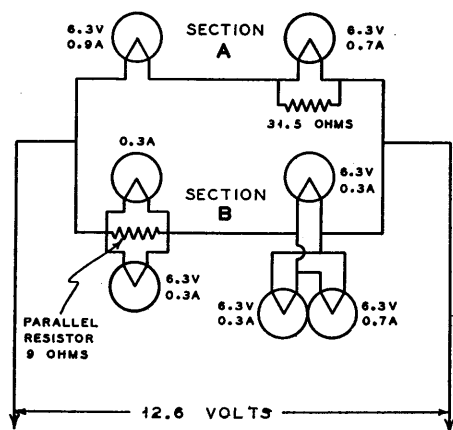

FIGURE 7.

The diagram in figure 7 shows other possible connections for tubes of dissimilar heater or filament current ratings. Although section B in figure 7 appears formidable, it is a simple matter to make the necessary calculations for operating the tubes from a common source of supply. In section B there are three tubes with their heaters connected in parallel. The current, therefore, will be $0.3 + 0.3 + 0.7 = 1.3$ amps. The two tubes in parallel draw $0.3 + 0.3 = 0.6$ amp. The difference between 1.3 and 0.6 is 0.7 amp. The drop across each section is the same or 6.3 volts;

therefore $\frac{6.3}{0.7} = 9$ ohms. This value of

resistance across the two parallel-connected tubes gives their sections the same resistance as that of the three tubes; consequently, all tubes secure the proper voltage.

When tube heaters or filaments are operated in series, the current is the same throughout the entire circuit. The resistance of all tube filaments must then be made the same if each is to have the same voltage drop across its terminals. The resistance of a tube heater or filament should never be measured when cold because the resistance will be only a fraction of the resistance present when the tube functions at proper heater or filament temperature. The resistance can be calculated satisfactorily by using the current and voltage ratings given in the tube tables.

Alternating Current

So far in this text, consideration has been given only to a steady flow of electrons in one direction. Such currents are known as *unidirectional* or *direct currents*, abbreviated *d.c.* Radio and electrical practice also makes use of another and altogether different kind of current, known as *alternating current* and abbreviated *a.c.*

An alternating current begins to flow in one direction, meanwhile changing its amplitude from zero to a maximum value, then down again to zero, from which point it changes its direction, and again goes through the same procedure. Each one of these zero-maximum-zero amplitude changes in a given direction is called a *half cycle*. The complete change in two directions is called a *cycle*. The number of times per second that the current goes through a complete cycle is called the *frequency*. The frequency of common house-lighting alternating current is generally 60 cycles, meaning that it goes through 60 complete cycles (120 reversals) per second.

High radio-frequency currents, on the other hand, go through so many of these changes per second that the term *cycle* becomes unwieldy. As an example, it can be said that a certain station is operating on 14,000,000 cycles. However, it is simpler to say 14,000 *kilocycles*, or 14 *megacycles*. A conversion table for sim-

plifying this terminology is given here:

- 1,000 cycles = 1 kilocycle. The abbreviation for kilocycle is kc.
- 1 cycle = 1/1,000 of a kilocycle, .001 kc. or 10^{-3} kc.
- 1 megacycle = 1,000 kilocycles, or 1,000,000 cycles, 10^3 kc. or 10^6 cycles.
- 1 kilocycle = 1/1,000 megacycle, .001 megacycle, or 10^{-3} Mc. The abbreviation for megacycles is Mc.

Ohm's Law Applied to Alternating Current

Ohm's law applies equally to direct or alternating current, *provided* that the circuits under consideration are purely resistive, that is, circuits which have neither inductance (coils) nor capacitance (condensers). Problems which involve tube filaments, drop resistors, electric lamps, heaters or similar resistive devices can be solved from Ohm's law, regardless of whether the current is direct or alternating. When a condenser or a coil is made a part of the circuit, a property common to each, called *reactance*, must be taken into consideration. Reactance will be treated under a separate heading.

Electromagnetic Effects

When an electric current flows through a conductor, the moving electrons which comprise this current set up *lines of force* in the surrounding medium. These are termed *lines of magnetic force*, and they extend outwardly from the conductor in a plane at right angles to its direction. It is these lines of magnetic force that make up the *magnetic flux*.

In drawing an analogy of voltage, current and resistance in terms of magnetic phenomena, magnetic flux might be termed *magnetic current*, *magnetomotive force* or *magnetic voltage*. The *reluctance* of a magnetic circuit can be thought of as the resistance of the magnetic path. The relation between the three is exactly the same as that between current, voltage and resistance (Ohm's law).

The magnetic flux depends upon the material, cross section and length of the magnetic circuit, and it varies directly as the current flowing in the circuit. The *reluctance* is dependent upon the length, cross section, permeability and

air gap, if any, of the magnetic circuit. In the electrical circuit, the current would equal the voltage divided by the resistance, and so it is in the magnetic circuit.

$$\text{Magnetic Flux } (\Phi) = \frac{\text{magnetomotive force (m.m.f.)}}{\text{reluctance } (r)}$$

Permeability

Permeability describes the difference in the magnetic properties of any magnetic substance as compared with the magnetic properties of air. Iron, for example, has a permeability of around 2,000 times that of air, which means that a given amount of magnetizing effect produced in an iron core by a current flowing through a coil of wire will produce 2,000 times the *flux density* that the same magnetizing effect would produce in air. The permeabilities of different iron *alloys* vary quite widely and permeabilities up to 100,000 can be obtained.

Permeability is similar to *electric conductivity*. There is, however, one important difference: the permeability of iron is not independent of the magnetic current (flux) flowing through it, although electrical conductivity is usually independent of electric current in a wire. After a certain point is reached in the flux density of a magnetic conductor, an increase in the magnetizing field will not produce a material increase in flux density. This point is known as the *point of saturation*. The inductance of a choke

GREEK LETTER	GREEK NAME
Α α	Alpha
Β β	Beta
Γ γ	Gamma
Δ δ	Delta
Ε ε	Epsilon
Ζ ζ	Zeta
Η η	Eta
Θ θ	Theta
Ι ι	Iota
Κ κ	Kappa
Λ λ	Lambda
Μ μ	Mu
Ν ν	Nu
Ξ ξ	Xi
Ο ο	Omicron
Π π	Pi
Ρ ρ	Rho
Σ σ	Sigma
Τ τ	Tau
Υ υ	Upsilon
Φ φ	Phi
Χ χ	Chi
Ψ ψ	Psi
Ω ω	Omega

coil whose core is saturated declines to a very low value.

Ampere Turns

The magnetizing effect of a coil is often described in *ampere turns*. Two *amperes* of current flowing through one *turn* is equal to two *ampere turns*. From this it can be seen that the flux can be increased by either increasing the current through the conductor or by making the conductor into the form of a coil of many turns. As a means of showing why the flux is increased when the conductor is put into the form of a coil, two figures are given here:

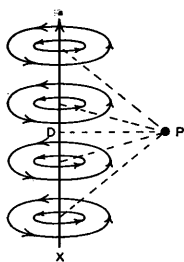

FIGURE 8A.

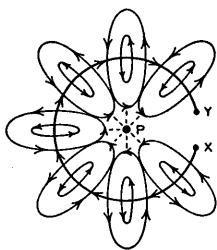

FIGURE 8B.

An arbitrary point P is chosen in A of figure 8 to represent a point at some fixed distance from a straight conductor X-Y. Upon examination, it will be seen that the maximum effect will be exerted on X-Y by the lines of force which are nearest this point, or at D. The field intensity at the fixed point is the resultant or *vector sum* of all the fields due to the individual electron flow along the conductor.

Other fields than those at the shortest distance will then have less and less effect as they lie farther along the conductor. If the conductor is arranged in the shape shown in B of figure 8, it will readily be seen that all of the fields along the conductor will act equally on the central point P, with the result that the field is greatly strengthened.

When a conductor is wound into a number of turns in the form of a coil, the flux which encircles the current flowing through an individual *turn* also links the turn adjacent to it. Thus, in a multi-turn coil, the magnetic field which is pro-

duced will be much greater than if only a single turn were used. This flux increases or decreases in direct proportion to the change in the current. The ratio of the change in flux to the change in current has a constant value known as the *inductance* of a coil.

Counter E.M.F.

A fundamental law of electricity is: when lines of force cut across a conductor, a voltage is induced in that conductor. Therefore, it can be readily seen that in the case of the coil previously mentioned the flux lines from one turn cut across the adjacent turn, and a *voltage* is induced in that turn. The effect of these induced voltages is to create a voltage across the entire coil of opposite polarity or in the opposite direction to the original voltage. Such a voltage is called *counter e.m.f.* or *back e.m.f.*

If a direct current potential such as a battery is connected across a multi-turn coil or inductance, the back e.m.f. will exist only at the instant of connection at which time the flux is rising to its maximum value. While it is true that a current is flowing through the turns of the coil and that a magnetic field exists around and through the center of the inductance, an induced voltage may only be produced by a *changing flux*. It is only such a changing flux that will cut across the individual turns and induce a voltage in them. By a changing flux is meant a flux that is increasing or decreasing as would occur if the e.m.f. across the coil were alternating or changing its direction periodically.

As the current increases, the back e.m.f. reaches a maximum; as the current decreases, the back e.m.f. is maximum in the *same* direction as the current. This back voltage is always *opposite* to the exciting voltage and, hence, always acts to resist any *change* in current in the inductance. This property of an inductance is called its *self-inductance* and is expressed in *henrys*, the henry being the unit of inductance. A coil has an inductance of one henry when a voltage of one volt is induced by a current change of one ampere per second. The unit, *henry*, is too large for reference to inductance coils such as those used in radio-frequency circuits; *millihenry* or *microhenry* are more commonly used, in the following manner:

1 henry = 1,000 millihenrys, or 10^3 millihenrys.

1 millihenry = 1/1,000 of a henry, .001 henry, or 10^{-3} henry.

1 microhenry = 1/1,000,000 of a henry, or .000001 henry, or 10^{-6} henry.

One one-thousandth of a millihenry = .001 or 10^{-3} millihenrys.

1,000 microhenrys = 1 millihenry.

Mutual Inductance

If two inductances are so placed in relation to each other that the lines of force encircling one coil are interlinked with the turns of the other, a voltage will be set up or *induced* in the second coil. As in the case of self-inductance, the *induced voltage* will be opposite in direction to the exciting voltage. This effect of linking two inductances is called *mutual inductance*, abbreviated *M*, and is also expressed in henrys. Two circuits thus joined are said to be *inductively coupled*.

The magnitude of the mutual inductance depends upon the shape and size of the two circuits, their positions and distances apart and the permeability of the medium. The extent to which two inductances are coupled is expressed by a relation known as *coefficient of coupling*. This is the ratio of the mutual inductance actually present to the maximum possible value.

Inductances in Parallel

Inductances in parallel are combined exactly as are resistors in parallel, provided that they are far enough apart so that the mutual inductance is entirely negligible, i.e., if the coupling is very loose.

Inductances in Series

Inductances in series are additive, just as are resistors in series, again provided that no mutual inductance exists. In this case, the total inductance *L* is:

$$L = L_1 + L_2 + \dots \text{etc.}$$

Where mutual inductance does exist:

$$L = L_1 + L_2 + 2M,$$

where *M* is the mutual inductance.

This latter expression assumes that the coils are connected in such a way that all flux linkages are in the same direction, i.e., additive. If this is not the case and the mutual linkages sub-

tract from the self-linkages, the following formula holds:

$$L = L_1 + L_2 - 2M,$$

where *M* is the mutual inductance.

Calculating Inductance Formulas

The inductance of coils with magnetic cores can be determined with reasonable accuracy from the formula:

$$L = 1.257 \times N^2 \times P \times 10^{-9}$$

where

L is the inductance in henrys,

N is the number of turns,

P is the permeability of the core material.

From this formula it can be seen that the inductance is proportional to the permeability as well as to the square of the number of turns. Thus, it is possible to secure greater values of inductance with a given number of turns of wire wound on an iron core than would be possible if an air core coil were used.

The inductance of an air core coil is proportional to the square of the number of turns of wire, provided that the length and diameter remain constant as the turns are changed (actually an impossibility, strictly speaking). The formula for inductance of air core coils is given with good accuracy, as follows:

$$L = N^2 \times d \times F,$$

where

L = inductance in microhenrys,

d = diameter of coil, measured to center of wire,

N = number of turns,

F = a constant, dependent upon the ratio of length-to-diameter.

This formula is explained under the heading of *Coil Calculation*, where a graph for the constant *F* is given.

Core Material

Ordinary magnetic cores cannot be used for radio frequencies because the *eddy current losses* in the core material become enormous as the frequency is increased. The principal use for magnetic cores is in the audio-frequency range below approximately 15,000 cycles, whereas at very low frequencies (50 to 60 cycles) their use is mandatory if an appreciable value of inductance is desired.

An air core inductor of only one henry inductance would be quite large in size, yet values as high as 100 henrys

are commonly available in small iron core chokes. The inductance of a coil with a magnetic core will vary with the amount of direct current which passes through the coil. For this reason, iron core chokes that are used in power supplies have a certain inductance rating at a *predetermined value of d.c.*

One exception to the statement that metal core inductances are highly inefficient at radio frequencies is in the *powdered* iron cores used in some types of intermediate frequency transformers. These cores are made of very *fine particles* of powdered iron, which is first treated with an insulating compound so that each particle is insulated from the other. These particles are then molded into a solid core around which the wire is wound. Eddy current losses are greatly reduced, with the result that these special iron cores are entirely practical in circuits which operate up to 1,500 kc. in frequency.

Mutual Conductance

The unit of conductance is the *mho*, which can be recognized as *ohm* spelled backward. Transconductance, or mutual conductance, is expressed in *micromhos*; the latter is 1/1,000,000 of a mho. A mutual conductance of 5,000 micromhos would be .005 mhos.

Energy Stored in a Magnetic Field

The stored energy in a magnetic field is expressed in *joules* and is equal to $L \times I^2$

2

Transformers: Primary—Secondary

When two coils are placed in such inductive relation to each other that the lines of force from one cut across the turns of the other and induce a voltage in so doing, the combination can be called a *transformer*. The name is derived from the fact that energy is transformed from one coil into another. The inductance in which the original flux is produced is called the *primary*; the inductance which *receives* the induced voltage is called the *secondary*. In a radio receiver power transformer, for example, the coil through which the 110-volt

a.c. passes is the *primary*, and the coil from which a higher or lower voltage than the a.c. line potential is obtained is the *secondary*.

Transformers can have either air or magnetic cores, depending upon whether they are to be operated at radio or audio frequencies. The reader should thoroughly impress upon his mind the fact that current can be transferred from one circuit to another *only* if the primary current is changing or alternating. From this it can be seen that a power transformer cannot possibly function as such when the primary is supplied with non-pulsating d.c.

A power transformer usually has a magnetic core which consists of laminations of iron, built up into a square or rectangular form, with a center opening or window. The secondary windings may be several in number, each perhaps delivering a different voltage. The secondary voltages will be proportional to the number of turns and to the primary voltage.

If a primary winding has an a.c. potential of 110 volts applied to 220 turns of wire on the primary, it is evident that this winding will have two turns per volt. A secondary winding of 10 turns, wound on an adjacent leg of the transformer core, would have a potential of 5 volts. If the secondary winding has 500 turns, the potential would be 250 volts, etc. Thus, a transformer can be designed to have either a step-up or step-down ratio, or both simultaneously. The same applies to air core transformers for radio-frequency circuits.

Inductive Reactance

As was previously stated, when an alternating current flows through an inductance, a back- or counter-electromotive force is developed; this force opposes any change in the initial e.m.f. The property of an inductance to offer opposition to a change in current is known as its *reactance* or *inductive reactance*. This is expressed as X_L :

$$X_L = 2\pi fL,$$

where X_L = inductive reactance expressed in ohms,

$$\pi = 3.1416 \quad (2\pi = 6.283),$$

f = frequency in cycles,

L = inductance in henrys.

It is very often necessary to compute inductive reactance at radio frequencies.

The same formula may be used, except that the units in which the inductance and the frequency are expressed will be changed. Inductance can, therefore, be expressed in *millihenrys* and frequency in *kilocycles*. For higher frequencies and smaller values of inductance, frequency is expressed in *megacycles* and inductance in *microhenrys*. The basic equation need not be changed since the multiplying factors for inductance and frequency appear in numerator and denominator, and hence are cancelled out. However, it is not possible in the same equation to express L in millihenrys and f in cycles without conversion factors.

Should it become desirable to know the value of inductance necessary to give a certain reactance at some definite frequency, a transposition of the original formula gives the following:

$$L = \frac{X_L}{2\pi f}$$

or when X_L and L are known:

$$f = \frac{X_L}{2\pi L}$$

Capacity; Condensers

Two metallic plates separated from each other by a thin layer of insulating material (called a *dielectric*, in this case), become a *condenser*. When a source of d.c. potential is momentarily applied across these plates, they may be said to become charged. If the same two plates are then joined together momentarily by means of a wire, the condenser will *discharge*.

When the potential was first applied, electrons immediately started to flow from one plate and to the other through the battery or such source of d.c. potential as was applied to the condenser plates. However, the circuit from plate to plate in the condenser was *incomplete* (the two plates being separated by an insulator) and thus the electron flow ceased, meanwhile establishing a shortage of electrons on one plate and a surplus of electrons on the other.

Remember that when a deficiency of electrons exists at one end of a conductor, there is always a tendency for the electrons to move about in such a manner as to reestablish a state of balance. In the case of the condenser herein discussed, the surplus quantity of electrons on one

of the condenser plates cannot move to the other plate because the circuit has been broken; that is, the battery or d.c. potential was removed. This leaves the condenser in a *charged* condition; the condenser plate with the electron deficiency is *positively* charged, the other plate being *negative*.

In this condition, a considerable stress exists in the insulating material (dielectric) which separates the two condenser plates, due to the mutual attraction of two unlike potentials on the plates. This stress is known as *electrostatic energy*, as contrasted with *electromagnetic energy* in the case of an inductance. This charge can also be called *potential energy* because it is capable of performing work when the charge is released through an external circuit.

If the external circuit of the two condenser plates is completed by joining the terminals together with a piece of wire, the electrons will rush immediately from one plate to the other through the external circuit and establish a state of equilibrium. This latter phenomenon explains the *discharge* of a condenser. The amount of stored energy in a charged condenser is dependent upon the charging potential, as well as a factor which takes into account the *size* of the plates, *dielectric thickness*, *nature* of the dielectric and the *number* of plates. This factor, which is determined by the foregoing, is called the *capacity* of a condenser and is expressed in farads.

$$\text{Stored energy in joules} = \frac{C \times E^2}{2}$$

where C = the capacity in farads,
E = potential in volts.

The *farad* is such a large unit of capacity that it is rarely used in radio calculations, and the following more practical units have, therefore, been chosen:

- 1 *microfarad* = 1/1,000,000 of a farad, or .000001 farad, or 10^{-6} farads.
- 1 *micro-microfarad* = 1/1,000,000 of a microfarad, or .000001 microfarad, or 10^{-12} microfarads.
- 1 *micro-microfarad* = one-million-millionth of a farad, or .000000000001 farad, or 10^{-12} farads.

If the capacity is to be expressed in *microfarads* in the equation just given,

22 RADIO Handbook

the factor C would then have to be divided by 1,000,000, thus:

$$\text{Stored energy in joules} = \frac{C \times E^2}{2 \times 1,000,000}$$

This storage of energy in a condenser is one of its very important properties, particularly in those condensers which are used in power supply filter circuits.

Dielectric Constant

The capacity of a condenser is largely determined by the thickness and nature of the dielectric separation between plates. Certain materials offer a greater capacity than others, depending upon their physical makeup. This property is expressed by a constant K, called the dielectric constant. A table for some of the commonly used dielectrics is given here:

Material	Dielectric Constant
Air	1.00
Mica	2.94
Hard rubber	2.50 to 3.00
Glass	4.90 to 7.00
Bakelite derivatives	3.50 to 6.00
Celluloid	4.10
Fiber	4 to 6
Wood (without special preparation):	
Oak	3.3
Maple	4.4
Birch	5.2
Transformer oil	2.5
Castor oil	5.0
Porcelain	4.4

Dielectric Breakdown

The nature and thickness of a dielectric have a very definite bearing on the amount of charge of a condenser. If the charge becomes too great for a given thickness of dielectric, the condenser will break down, i.e., the dielectric will puncture. It is for this reason that condensers are rated in the manner of the amount of voltage they will safely withstand. This rating is commonly expressed as the *d.c. working voltage*.

Capacity Calculation

The capacity of two parallel plates is given with good accuracy by the following formula:

$$C = 0.2244 \times K \times \frac{A}{t}$$

where C = capacity in micro-microfarads
 K = dielectric constant of spacing material,
 A = area of dielectric in square inches,
 t = thickness of dielectric in inches,

This formula indicates that the capacity is directly proportional to the area of the plates and inversely proportional to the thickness of the dielectric (spacing between the plates). This simply means that when the area of the plate is doubled, the spacing between plates remaining constant, the capacity will be doubled. Also, if the area of the plates remains constant, and the plate spacing is doubled, the capacity will be reduced to half. The above equation also shows that capacity is directly proportional to the dielectric constant of the spacing material. A condenser that has a capacity of 100 in air would have a capacity of 500 when immersed in castor oil, because the dielectric constant of castor oil is 5.0 or five times greater than the dielectric constant of air.

In order to determine the capacity of a parallel plate condenser, the following transposition is of value when the spacing between plates is known:

$$A = \frac{C \times t}{0.2244 \times K}$$

where A = area of plates in square inches,
 K = dielectric constant of spacing material,
 C = capacity in micro-microfarads,

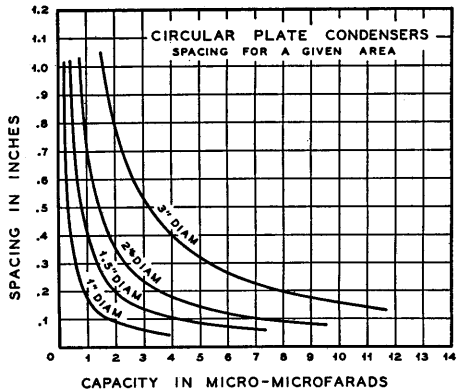

FIGURE 9.

t = thickness of dielectric (plate spacing) in inches.

Where the area of the plates is definitely set, and when it is desired to know the spacing needed to secure a required capacity,

$$t = \frac{A \times 0.2244 \times K}{C}$$

where all units are expressed just as in the preceding formula. This formula is not confined to condensers having only square or rectangular plates, but also applies when the plates are circular in shape. The only change will be the calculation of the *area* of such circular plates; this *area* can be computed by squaring the *radius* of the plate, then multiplying by 3.1416, or "pi". Expressed as an equation:

$$A = 3.1416 \times r^2,$$

where r = radius in inches.

The capacity of a multi-plate condenser can be calculated by taking the capacity of one section and multiplying this by the number of dielectric spaces. In such cases, however, the formula gives no consideration to the effects of edge capacity so that the capacity as calculated will not be entirely accurate. These additional capacities will be but a small part of the effective total capacity, particularly when the plates are reasonably large, and the final result will, therefore, be within practical limits of accuracy.

Equations for calculating capacities of condensers in *parallel* connection are the same as those for resistors in *series*:

$$C = C_1 + C_2, \text{ etc.}$$

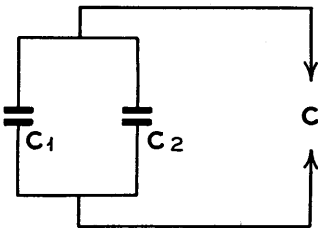

CONDENSERS IN PARALLEL

FIGURE 10.

Condensers in *series* connection are calculated in the same manner as are resistors in *parallel*.

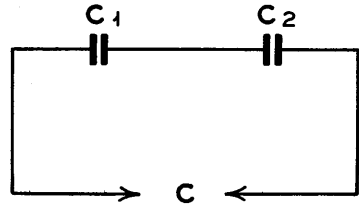

CONDENSERS IN SERIES

FIGURE 11.

The formulas are repeated: (1) For two or more condensers of *unequal* capacity in series:

$$C = \frac{1}{\frac{1}{C_1} + \frac{1}{C_2} + \frac{1}{C_3}}, \text{ or } \frac{1}{C} = \frac{1}{C_1} + \frac{1}{C_2} + \frac{1}{C_3}$$

(2) *Two* condensers of *unequal* capacity in series:

$$C = \frac{C_1 \times C_2}{C_1 + C_2}$$

(3) *Three* condensers of *equal* capacity in series:

$$C = \frac{C_1}{3}, \text{ where } C_1 \text{ is the common capacity.}$$

(4) *Three* or more condensers of *equal* capacity in series:

$$C = \frac{\text{Value of common capacity}}{\text{Number of condensers in series}}$$

(5) *Six* condensers in series parallel:

$$C = \frac{1}{\frac{1}{C_1} + \frac{1}{C_2} + \frac{1}{C_3} + \frac{1}{C_4} + \frac{1}{C_5} + \frac{1}{C_6}}$$

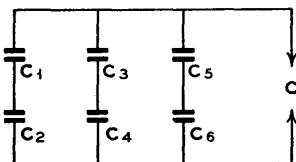

CONDENSERS IN SERIES - PARALLEL

FIGURE 12.

Voltage Rating of Series Condensers

Any good paper dielectric filter condenser has such a high internal resistance (indicating a good dielectric) that the exact resistance will vary considerably from condenser to condenser even though they are made by the same manufacturer and are of the same rating. Thus, when 1000 volts d.c. is connected across two 1- μ fd. 500-volt condensers, the chances are that the voltage will divide unevenly and one condenser will receive more than 500 volts and the other less than 500 volts.

By connecting a half-megohm 1-watt carbon resistor across each condenser, the voltage will be equalized because the resistors act as a voltage divider and the internal resistances of the condensers are so much higher (many megohms) that they have but little effect in disturbing the voltage divider balance.

Carbon resistors of the inexpensive type are not particularly accurate (not being designed for precision service); therefore it is advisable to check several on an accurate ohmmeter to find two that are as close as possible in resistance. The exact resistance is unimportant, just so it is the same for the two resistors used.

When two condensers are connected in series, *alternating* current pays no heed to the relatively high internal resistance of each condenser, but divides across the condensers in inverse proportion to the *capacity*. Because, in addition to the d.c. across a capacitor in a filter or audio amplifier circuit there is usually an a.c. or a.f. voltage component, it is inadvisable to series-connect condensers of unequal capacitance even if dividers are

provided to keep the d.c. within the ratings of the individual capacitors.

For instance, if a 500-volt 1- μ fd. capacitor is used in series with a 4- μ fd. 500-volt condenser across a 250-volt a.c. supply, the 1- μ fd. condenser will have 200-volts a.c. across it and the 4- μ fd. condenser only 50 volts. An equalizing divider to do any good in this case would have to be of very low resistance because of the comparatively low impedance of the condensers to a.c. Such a divider would draw excessive current and be impracticable.

The safest rule to follow is to use only condensers of the same capacity and voltage rating and to install matched high resistance proportioning resistors across the various condensers to equalize the d.c. voltage drop across each condenser. This holds regardless of how many capacitors are series-connected.

Similar electrolytic capacitors, of the same capacity and made by the same manufacturer, have more nearly uniform (and much lower) internal resistance though it still will vary considerably. However, the variation is not nearly as great as encountered in paper condensers, and the lowest d.c. voltage is across the weakest (leakiest) electrolytic condensers of a series group.

As an electrolytic capacitor begins to show signs of breaking down from excessive voltage, the leakage current goes up, which tends to heat the condenser and aggravate the condition. However, when used in series with one or more others, the lower resistance (higher leakage current) tends to put less d.c. voltage on the weakening condenser and more on the remaining ones. Thus, the capacitor with the *lowest* leakage current, usually the *best* capacitor, has the highest voltage across it. For this reason, dividing resistors are not essential across series-connected electrolytic capacitors.

Electrolytic condensers use a very thin film of oxide as the dielectric and are polarized; that is, they have a positive and a negative terminal which must be properly connected in a circuit; otherwise, the oxide will boil, and the condenser will no longer be of service. When electrolytic condensers are connected in series, the positive terminal is always connected to the positive lead of the power supply; the negative terminal of the condenser connects to the positive

terminal of the *next* condenser in the series combination. The method of connection is illustrated in figure 13.

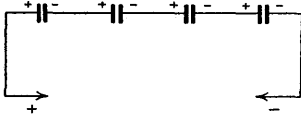

POLARIZED CONDENSERS, (ELECTROLYTIC) IN SERIES

FIGURE 13.

Condensers in A. C. and D. C. Circuits

When a condenser is connected into a direct current circuit, it will block the d.c. or stop the flow of current. Beyond the initial movement of electrons during which the condenser is charged, there will be no flow of current because the circuit is effectively broken by the dielectric of the condenser. Strictly speaking, a very small current may actually flow because the dielectric of the condenser may not be a perfect insulator. This minute current flow is the leakage current previously referred to and is dependent upon the internal d.c. resistance of the condenser. This leakage current is usually quite noticeable in most types of electrolytic condensers.

When an alternating current is applied to a condenser, it will charge and discharge a certain number of times per second in accordance with the frequency of the alternating voltage. The electron flow in the charge and discharge of a condenser when an a.c. potential is applied constitutes an alternating current, in effect. It is for this reason that a condenser will pass an alternating current yet offer practically infinite opposition to a direct current. These two properties are repeatedly in evidence in a radio circuit.

Capacitive Reactance

It has been explained that inductive reactance is the ability of an inductance to oppose a change in an alternating current. Condensers have a similar property although in this case the opposition is to the *voltage* which acts to charge

the condenser. This action is called *capacitive reactance* and is expressed as follows:

$$X_c = \frac{1}{2 \pi f C}$$

where X_c = capacitive reactance in ohms,
 π = 3.1416,
 f = frequency in cycles,
 C = capacity in farads.

Here again, as in the case of inductive reactance, the units of capacity and frequency can be converted into smaller units for practical problems encountered in radio work. The equation may be written:

$$X_c = \frac{1,000,000}{2 \pi f C}$$

where f = frequency in megacycles,
 C = capacity in micro-microfarads.

In the design of filter circuits, it is often convenient to express frequency (f) in *cycles* and capacity (C) in *microfarads*, in which event the same formula applies.

Comparison of Inductive to Capacitive Reactance with Changing Frequency

From the equation for *inductive* reactance, it is seen that as the frequency becomes greater the reactance increases in a corresponding manner. The reactance is doubled when the frequency is doubled. If the reactance is to be very large when the frequency is low, the value of inductance must be very large.

The equation for capacitive reactance shows that the reactance varies *inversely* with frequency and capacity. With a fixed value of capacity, the reactance will become less as the frequency increases. When the frequency is fixed, the reactance will be greater as the capacity is lowered. In order to have high reactance, it is necessary to have low capacitance although in power filter circuits the reactance is always made low so that the alternating current component from the rectifier will be by-passed. The capacitance must be made large in this case because the frequency is quite low (60-120 cycles).

A comparison of the two types of reactance, inductive and capacitive, shows that in one case (inductive) the reactance *increases* with frequency, where-

as the other (capacitive) the reactance *decreases* with frequency.

Reactance and Resistance in Combination

When a circuit includes a capacity or an inductance or both, in addition to a resistance, the simple calculations of Ohm's law will *not* apply when the total impedance to alternating current is to be determined. Reference is here made to the passage of an *alternating current* through the circuit; the reactance must be considered in addition to the d.c. resistance because reactance offers an opposition to the flow of alternating current.

When alternating current passes through a circuit which contains only a condenser, the voltage and current relations are as follows:

$$E = I X_c, \text{ and } I = \frac{E}{X_c},$$

where E = voltage,

I = current in amperes,

$$X_c = \text{capacitive reactance or } \frac{1}{2\pi fC}$$

(expressed in ohms).

When the circuit contains inductance only, yet with the same conditions as above, the formula is as follows:

$$E = I X_L, \text{ and } I = \frac{E}{X_L},$$

where E = voltage,

I = current in amperes,

$$X_L = \text{inductive reactance or } 2\pi fL$$

(expressed in ohms).

When a circuit has resistance, capacitive reactance and inductive reactance in *series*, the effective total opposition to the alternating current flow is known as the *impedance* of the circuit. Stated otherwise, impedance of a circuit is the vector sum of the resistance and the difference between the two reactances.

$$Z = \sqrt{r^2 + (X_L - X_c)^2} \text{ or}$$

$$Z = \sqrt{r^2 + \left(2\pi fL - \frac{1}{2\pi fC}\right)^2}$$

where Z = impedance in ohms,

r = resistance in ohms,

X_L = inductive reactance ($2\pi fL$) in ohms,

$$X_c = \text{capacitive reactance } \left(\frac{1}{2\pi fC}\right)$$

in ohms.

An example will serve to clarify the relationship of resistance and reactance to the total impedance. If a 10-henry choke, a 2- μ fd. condenser and a resistance of 10 ohms (which is represented by the d.c. resistance of the choke) are all connected in *series* across a 60-cycle source of voltage:

$$\text{for reactance } X_L = 6.28 \times 60 \times 10 = 3,750 \text{ ohms (approx.),}$$

$$X_c = \frac{1,000,000}{6.28 \times 60 \times 2} = 1,300 \text{ ohms (approx.)}$$

$$r = 10 \text{ ohms}$$

Substituting these values in the impedance equation:

$$Z = \sqrt{10^2 + (3750 - 1300)^2} = 2450 \text{ ohms.}$$

This is nearly 250 times the value of the d.c. resistance of 10 ohms. The subject of impedance is more fully covered under *Resonant Circuits*.

Again recalling previous text, an alternating current is one which rises to a maximum, then decreases to zero from that point, and then goes through the same pulse in the opposite direction. This continual change of amplitude and direction is maintained as long as the current continues to flow. The number of times that the current changes direction in a given length of time is called the frequency of change, or more generally, it is simply called the *frequency*.

Alternating currents which range from nearly zero to many millions of cycles per second are commonplace in radio applications. Such a current is produced by the rotating machine which generates the common 60-cycle house-lighting current; it is likewise produced by oscillatory circuits for the high radio frequencies. A machine that produces alternating current for house-lighting, industrial and other uses is called an *alternator*. It is also called an *a.c. generator*.

An alternator in its very basic form is shown in figure 14. It consists of two permanent magnets, M , the opposite poles of which face each other, and the poles being machined so that they have a common radius. Between these two poles, *north* (N) and *south* (S), magnetic lines of force exist; these lines of

force constitute a *magnetic field*. If a conductor in the form of C is so suspended that it can freely rotate between the two poles, and if the opposite ends of conductor C are brought to collector rings, R, which are contacted by brushes, there will be a flow of alternating current when conductor C is rotated. This is the basic method of producing alternating current.

If the conductor loop is rotated so that it cuts or passes through the magnetic lines of force between the pole pieces (magnets), a current will be induced in the loop, and this current will flow out through the collector rings R and brushes B to the external circuit, X-Y. As the rotation continues, the current becomes increasingly greater as the center of each pole piece is approached by the loop. The field intensity of the magnets is greatest at the center, and gradually falls to a low value either side of center.

Figure 15 will serve to clarify the operation of the alternator. The point P is taken as the revolving conductor, which is C in figure 14. As point P is revolved in a circular manner, the change in field intensity with consequent change in voltage can be visualized. It will be seen that as the conductor P begins its rotation, it starts through the lesser field intensity, gradually coming into the maximum field, then away again to another field of minimum intensity. The conductor then cuts the magnetic field in the *opposite* direction, going through the same varying intensity as previously related, then reaching a maximum, and then falling away to zero, from which point the current again increases in the original direc-

tion. When the conductor has completed its 360° rotation, two complete changes—one *cycle*—will have been completed.

Actually the voltage does *not* increase

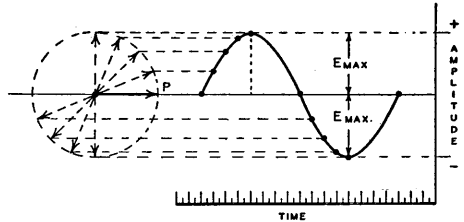
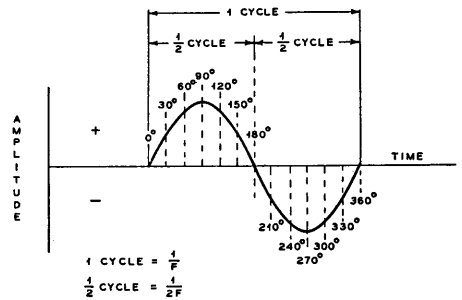

FIGURE 15.

directly as the angle of rotation, but rather as the *sine* of the angle; hence, such a current has the mathematical form of a *sine wave*. Although most electrical machinery does not produce a strictly pure sine curve, the departures



WHERE, F = FREQUENCY IN CYCLES PER SECOND

FIGURE 16.

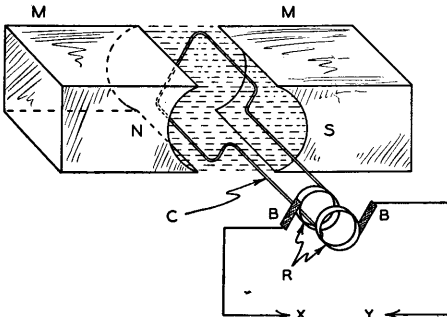

Figure 14. Basic form of alternator.

are usually so slight that the assumption can be regarded as fact for most practical purposes.

Referring to figure 16, it will be seen that if a curve is plotted for an alternating voltage, such a curve would assume the shape of a sine wave and by plotting amplitude against time, the voltage at any instant could be found. When dealing with alternating current of sine wave character, it becomes necessary to make constant use of terms which involve the number of changes in *polarity* or, more properly, the *frequency* of the current. The instantaneous value of voltage at any given instant can be calculated as follows:

$$e = E_{\max} \sin 2\pi ft,$$

where e = the instantaneous voltage,
 \sin = the sine of the angle formed by the revolving point P at the instant of time, t .

E = maximum crest value of voltage (figure 16).

The term $2\pi f$ should be thoroughly understood because it is of basic importance. Returning again to the rotating point P (figure 15), it can be seen that when this point leaves its horizontal position and begins its rotation in a counter-clockwise direction, through a complete revolution back to its initial starting point, it will have traveled through 360 electrical degrees. Instead of referring to this movement in terms of degrees, mathematical treatment dictates that the movement be expressed in *radians* or segments equal to the radius.

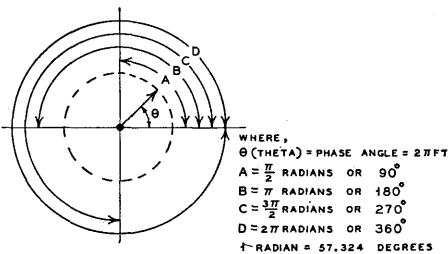

FIGURE 17.

If radians must be considered in terms of degrees, there are approximately 57.32 degrees in one radian. In simple language, the radian is nothing more than a unit for dividing a circle into many parts. In a complete circle (360 degrees), there are 2π radians. Figure 17 shows lesser divisions of a circle in radians.

When the expression 2π radians is used, it implies that the current or voltage has gone through a complete circle of 360 electrical degrees; this rotation represents two complete changes in direction during one cycle, as was previously shown. $2\pi f$ then represents one cycle, multiplied by the number of such cycles per second or the frequency of the alternating voltage or current. The expression $2\pi ft$ is a means of showing how far point P has traveled from its zero position toward a possible change of 2π radians or 360 electrical degrees.

In the case of an alternating current with a frequency of 60 cycles per second, the current must pass through *twice* 60 or 120 changes in polarity in the same length of time. This time can be expressed as:

$$\frac{1}{2f}$$

However, the only consideration at this point is one half of one alternation, and because the wave is symmetrical between 0 and 90 degrees rising, and from 90 degrees to zero when falling, the expression therefore becomes:

$$\frac{1}{4f}$$

The actual time t in the formula is seen to be only a fractional portion of a second; a 60-cycle frequency would make $\frac{1}{4f}$ equal to $\frac{1}{240}$ of a second at the maximum value, and correspondingly less at lower amplitudes. $2\pi ft$ represents the *angular velocity*, and since the instantaneous voltage or current is proportional to the *sine* of this angle, a definite means is secured for calculating the voltage at any instant of time, provided that the wave very closely approximates a sine curve.

Current and voltage are synonymous in the foregoing discussion since they both follow the same laws. The instantaneous current can be found from the same formula, except that the maximum current would be used as the reference, viz:

$$i = I_{\max} \sin 2\pi ft,$$

where i = instantaneous current,
 I_{\max} = maximum or peak current.

Effective Value of Alternating Voltage or Current

An alternating voltage or current in an a.c. circuit is rapidly changing in direction, and since it requires a definite amount of time for the indicator needle on a d.c. measuring instrument to show a deflection, such instruments cannot be used to measure alternating current or voltage. Even if the needle had such negligible damping that it could be made to follow the a.c. changes, it would merely vibrate back and forth near the zero point on the meter scale.

Alternating and direct current can be expressed in similar terms from the standpoint of heating effect. In other words, an alternating current will have the same value as a direct current in that it produces the same heating effect. Thus, an alternating current or voltage will have an equivalent value of one ampere when it produces the same heating effect in a resistance as does one ampere of direct current. This is known as the *effective value*; it is neither the maximum nor the instantaneous value, but an entirely different value.

This effective value is derived by taking the instantaneous values of current over a cycle of alternating current, then squaring these values, then taking an average of this value, and then taking the square root of the average thus obtained. By this procedure, the *effective value* becomes known as the *root mean square* or *r.m.s.* This is the value that is read on alternating current voltmeters and ammeters. The r.m.s. value is 70.7 per cent of the peak or maximum instantaneous value and is expressed as follows:

$$E_{\text{eff}} = 0.707 \times E_{\text{max}}, \text{ or}$$

$$I_{\text{eff}} = 0.707 \times I_{\text{max}},$$

where E_{max} and I_{max} are peak values of voltage and current respectively, and E_{eff} and I_{eff} are effective or r.m.s. values.

The following relations are extremely useful in radio and power work:

$$E_{\text{rms}} = 0.707 \times E_{\text{max}},$$

$$E_{\text{max}} = 1.414 \times E_{\text{rms}}.$$

In order to find the peak value when the effective or r.m.s. value is known, simply multiply the r.m.s. value by 1.414. When the peak value is known, multiply it by 0.707 to find the r.m.s. value.

Rectified Alternating Current or Pulsating Direct Current

If an alternating current is passed through a full-wave rectifier, it emerges in the form of a current of *varying amplitude* which flows in *one* direction only. Such a current is known as *rectified a.c.* or *pulsating d.c.* A typical wave form of a current of this nature is shown in figure 18.

Measuring instruments designed for d.c. operation will not read the peak or instantaneous maximum value of the pulsating d.c. output from the rectifier; it will read only the *average* value. This

can be explained by assuming that it could be possible to cut off some of the peaks of the waves, using the cut-off portions to fill in the spaces that are open, thereby obtaining an *average* d.c. value. A milliammeter and voltmeter connected to the adjoining circuit, or across the output of the rectifier, will

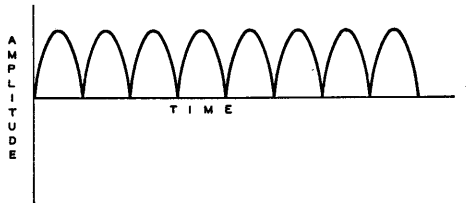

OUTPUT FROM FULL-WAVE RECTIFIER

FIGURE 18.

read this average value. It is related to *peak* value by the following expression:

$$E_{\text{avg}} = 0.636 \times E_{\text{max}}$$

It is thus seen that the average value is 63.6 per cent of the peak value.

Phase

When an alternating current flows through a purely resistive circuit, it will be found that the current will go through maximum and minimum in perfect step with the voltage. In this case the current is said to be in step or *inphase* with the voltage. For this reason, Ohm's law will apply equally well for a.c. or for d.c. where pure resistances are concerned, provided that the *effective* values of a.c. are used in the calculations.

If a circuit has capacity or inductance or both, in addition to resistance, the current does not reach a maximum at the same instant as the voltage; therefore Ohm's law will *not* apply. It has been stated that inductance tends to resist any change in current; when an inductance is present in a circuit through which an alternating current is flowing, it will be found that the current will reach its maximum *behind* or later than the voltage. In electrical terms, the current will *lag* behind the voltage or, conversely, the voltage will *lead* the current.

If the circuit is *purely* inductive, i.e., if it contains neither resistance nor ca-

capacitance, the current does not start until the voltage has first reached a maximum; the current, therefore, *lags* the voltage by 90 degrees as in figure 19. The angle will be less than 90 degrees if resistance is present in the circuit.

When pure *capacity* alone is present in an a.c. circuit (no inductance or resistance of any kind), the opposite effect will be encountered; the current will reach a maximum at the instant the voltage is starting and, hence, will *lead* the voltage by 90 degrees. The presence of resistance in the circuit will tend to decrease this angle.

Power Factor

It should now be apparent to the reader that in such circuits that have reactance as well as resistance, it will not be possible to calculate the power as in a d.c. circuit or as in an a.c. circuit in which current and voltage are in-phase. The reactive components cause the voltage and current to reach their maximums at different times, as was explained under *phase*, and to calculate the power in such a circuit we must use a figure called the *power factor* in our computations.

The *power factor* in a resistive-react-

tive a.c. circuit may be expressed as the *actual* watts (as measured by a wattmeter) divided by the product of voltage and current or:

$$\frac{W}{E \times I}$$

where W = watts as measured,

E = voltage (r.m.s.)

I = current in amperes (r.m.s.).

Stated in another manner:

$$\frac{W}{E \times I} = \cos \theta$$

The character θ is the angle of phase difference between current and voltage. The product of volts times amperes gives the *apparent* power of the circuit, and this must be multiplied by the $\cos \theta$ to give the *actual* power. This factor $\cos \theta$ is called the *power factor* of the circuit.

When the current and voltage are in-phase, this factor is equal to 1. Resonant or purely resistive circuits are then said to have unity power factor, in which case

$$W = E \times I. \quad W = I^2 R. \quad W = \frac{E^2}{R}$$

Resonant Circuits

The reader is advised to review at this point the subject matter on inductance, capacity and alternating current in order that he may gain a complete understanding of the action of resonant circuits. Once the basic conception of the foregoing has been mastered, the more complex circuits in which they appear in combination will present no great problem.

Figure 20 shows an inductance, a capacitance and a resistance arranged in series, with a variable frequency source, E, of a.c. applied across the combination.

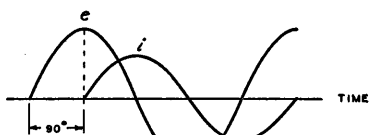

CURRENT LAGGING VOLTAGE BY 90°

(CIRCUIT CONTAINING PURE INDUCTANCE ONLY)

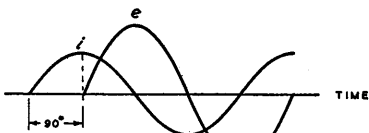

CURRENT LEADING VOLTAGE BY 90°

(CIRCUIT CONTAINING PURE CAPACITY ONLY)

FIGURE 19.

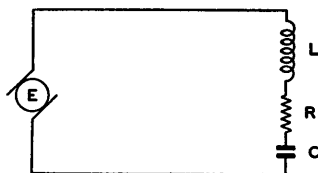
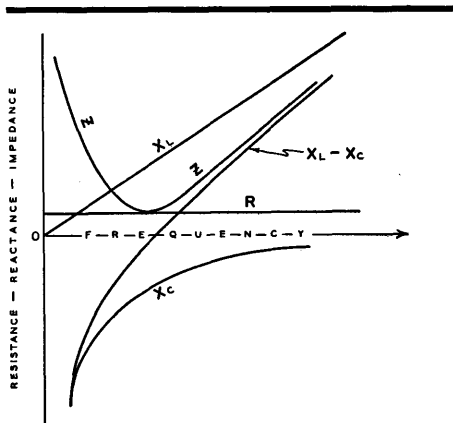

FIGURE 20.

Some resistance is always present in a circuit because it is possessed in some degree by both the inductance and capacitor. If the frequency of the alternator E is varied from nearly zero to some high frequency, there will be one particular frequency at which the inductive reactance and capacitive reactance will be equal. This is known as the *resonant frequency*, and in a series circuit it is the frequency at which the circuit current will be a maximum. Such series resonant circuits are chiefly used when it is desirable to allow a certain frequency to pass through the circuit (low impedance to this frequency), while at the same time the circuit is made to offer considerable opposition to currents of other frequencies.



SERIES CIRCUIT REACTANCE VARIATION WITH CHANGE OF APPLIED FREQUENCY

FIGURE 21.

If the values of inductance and capacity both are fixed, there will be only one resonant frequency.

If both the inductance and capacitance are made variable, the circuit may then be changed or *tuned*, so that a number of combinations of inductance and capacitance can resonate at the same frequency. This can be more easily understood when one considers that inductive reactance and capacitive reactance travel in opposite directions as the frequency is changed. For example, if the frequency were to remain constant and the values of inductance and capacitance were then changed, the following combinations would have equal reactance:

Frequency is constant at 60 cycles.

L is expressed in henrys.

C is expressed in microfarads (.000001 farad.)

L	X_L	C	X_C
.265	100	26.5	100
2.65	1,000	2.65	1,000
26.5	10,000	.265	10,000
265.00	100,000	.0265	100,000
2,650.00	1,000,000	.0026	1,000,000

In the above table there are five radically different ratios of L to C (inductance to capacitance) each of which satisfies the resonant condition, $X_L = X_C$. When the frequency is constant, L must increase and C must decrease in order to give equal reactance. Figure 21 shows how the two reactances change with frequency; this illustration will greatly aid in clarifying this discussion.

For mechanical reasons, it is more common to change the capacitance rather than the inductance when a circuit is

tuned, yet the inductance can be made variable if desired.

Formula for Frequency

From the formula for resonance,

$$2\pi fL = \frac{1}{2\pi fC}, \text{ the resonant frequency}$$

can readily be solved. In order to isolate f on one side of the equation, merely multiply both sides by $2\pi f$, thus giving:

$$4\pi^2 f^2 L = \frac{1}{C}$$

Dividing by the quantity $4\pi^2 L$, the result is: $f^2 = \frac{1}{4\pi^2 LC}$

Then, by taking the square root of both sides: $f = \frac{1}{2\pi \sqrt{LC}}$

where f = frequency in cycles,
 L = inductance in henrys,
 C = capacity in farads.

It is more convenient to express L and C in smaller units, especially in making radio-frequency calculations; f can also be expressed in megacycles or kilocycles. A very useful group of such formulas is:

$$f^2 = \frac{25,330}{LC} \text{ or } L = \frac{25,330}{fC} \text{ or } C = \frac{25,330}{fL}$$

where f = frequency in megacycles,
 L = inductance in microhenrys,
 C = capacity in micromicrofarads.

In order to clarify the original formula,

$f = \frac{1}{2\pi\sqrt{LC}}$, take two values of inductance and capacitance from the previously given chart and substitute these in the formula. It was stated that the frequency is 60 cycles; therefore $f = 60$. Substituting these values to check this frequency:

$$60 = \frac{1}{2\pi\sqrt{LC}}; \quad 3,600 = \frac{1}{4\pi^2 LC}$$

$$L = \frac{1}{3600 \times 4\pi^2 \times .000026}$$

$$L = 0.265$$

The significant point here is that the formula calls for C in *farads*, whereas the capacity was actually in microfarads. Recalling that one microfarad equals .000001 farad, it is, therefore, possible to express 26 microfarads as .000026 farads. This consideration is often overlooked when computing for frequency and capacitive reactance because capacitance is expressed in a totally impractical unit, viz: the *farad*.

Impedance of Series Resonant Circuits

The impedance across the terminals of a series resonant circuit (figure 20) is

$$Z = \sqrt{r^2 + (X_L - X_C)^2}$$

where Z = impedance in ohms,
 r = resistance in ohms,
 X_C = capacitive reactance in ohms,
 X_L = inductive reactance in ohms.

From this equation, it can be seen that the impedance is equal to the vector sum of the circuit resistance and the *difference* between the two reactances. Since at the resonant frequency X_L equals X_C , the difference between them (figure 21) is obviously zero so that at resonance the impedance is simply equal to the resistance of the circuit; therefore, because the resistance of most normal radio-frequency circuits is of a very low order, the impedance is also low.

At frequencies higher and lower than the resonant frequency, the difference between the reactances will be a definite quantity and will add with the resistance

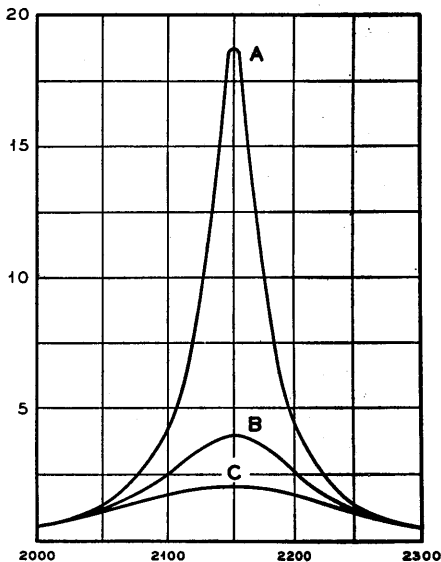

FIGURE 22.

to make the impedance higher and higher as the circuit is tuned off the resonant frequency.

Current and Voltage in Series Resonant Circuits

Formulas for calculating series resonance are similar to those of Ohm's law.

$$I = \frac{E}{Z} \quad E = IZ$$

The complete equations:

$$I = \frac{E}{\sqrt{r^2 + (X_L - X_C)^2}}$$

$$E = I\sqrt{r^2 + (X_L - X_C)^2}$$

Inspection of the above formulas will show the following to apply to series resonant circuits: When the impedance is low, the current will be high; conversely, when the impedance is high, the current will be low.

Since it is known that the impedance will be very low at the resonant frequency, it follows that the current will be a maximum at this point. If a graph is plotted of the current against the frequency either side of resonance, the resultant curve becomes what is known as a *resonance curve*. Such a curve is shown in figure 22.

Several factors will have an effect on

the shape of this resonance curve, of which resistance and L-to-C ratio are the important considerations. The curves B and C in figure 22 show the effect of adding increasing values of resistance to the circuit. It will be seen that the peaks become less and less prominent as the resistance is increased; thus, it can be said that the *selectivity* of the circuit is thereby *decreased*. Selectivity in this case can be defined as the ability of a circuit to discriminate against frequencies adjacent to the resonant frequency.

Referring again to figure 22, it can be seen from curve A that a signal, for instance, will drop from 19 to 5, or more than 10 decibels, at 50 kc. off resonance. Curve B, which represents considerable resistance in the circuit, shows a signal drop of from 4 to 3, or approximately 2.5 decibels, when the signal is also 50 kilocycles removed from the resonant point. From this it becomes evident that the steeper the resonant curve, the greater will be the change in current for a signal removed from resonance by a given amount. The effect of adding more resistance to the circuit is to flatten off the peaks without materially affecting the sides of the curve. Thus, signals far removed from the resonance frequency give almost the same value of current, regardless of the amount of resistance present.

Voltage Across Coil and Condenser in Series Circuit

Because the a.c. or r.f. voltage across a coil and condenser is proportional to the reactance (for a given current), the actual voltages across the coil and across the condenser may be many times greater than the *terminal* voltage of the circuit. Furthermore, since the individual reactances can be very high, the voltage across the condenser, for example, may be high enough to cause flash-over even though the applied voltage is of a value considerably below that at which the condenser is rated.

Circuit Q

An extremely important property of an inductance is its factor-of-merit, more generally called its Q. This factor can be expressed as the ratio of the reactance to the resistance, as follows:

$$Q = \frac{2\pi fL}{R}$$

where R = total d.c. and r.f. resistances.

The actual resistance in a wire or inductance can be far greater than the d.c. value when the coil is used in a radio-frequency circuit; this is because the current does not travel through the entire cross-section of the conductor, but has a tendency to travel closer and closer to the surface of the wire as the frequency is increased. This is known as the *skin effect*.

The actual current-carrying portion of the wire is decreased, therefore, and the resistance is increased. This effect becomes even more pronounced in square or rectangular conductors because the principal path of current flow tends to work outwardly toward the four edges of the wire.

Examination of the equation for Q may give rise to the thought that even though the resistance becomes greater with frequency, the inductive reactance does likewise, and that the Q might be a constant. In actual practice, however, the resistance usually increases more rapidly with frequency than does the reactance, with the result that Q normally decreases with increasing frequency.

Parallel Resonance

In radio circuits, parallel resonance is more frequently encountered than series resonance; in fact, it is the basic foundation of receiver and transmitter circuit operation. A circuit is shown in figure 23.

In this circuit, as contrasted with a circuit for series resonance, L (inductance) and C (capacitance) are con-

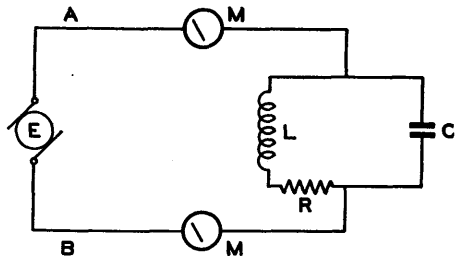

FIGURE 23.

nected in *parallel*, yet the *combination* can be considered to be in series with the remainder of the circuit. This combination of L and C, in conjunction with R, the resistance which is principally included in L, is sometimes called a *tank circuit* because it effectively functions as a storage tank when incorporated in vacuum tube circuits.

Contrasted with series resonance, there are two kinds of current which must be considered in a parallel resonant circuit: (1) the line current, as read on the indicating meters M, (2) the circulating current which flows within the parallel L-C-R portion of the circuit. See figure 23.

At the resonant frequency, the line current (as read on the meters M) will drop to a very low value although the circulating current in the L-C circuit may be quite large. It is this line current that is read by the milliammeter in the plate circuit of an amplifier or oscillator stage of a radio transmitter, and it is because of this that the meter shows a sudden *dip* as the circuit is tuned through its resonant frequency. The current is, therefore, a minimum when a parallel resonant circuit is tuned to resonance, although the *impedance* is a *maximum* at this same point. It is interesting to note that the parallel resonant circuit, in this respect, acts in a distinctly opposite manner to that of a series resonant circuit, in which the current is at a maximum when the impedance is minimum. It is for this reason that in a parallel resonant circuit the principal consideration is one of impedance rather than current. It is also significant that the *impedance* curve for *parallel* circuits is very nearly identical to that of the *current* curve for *series* resonance. The impedance at resonance is expressed as:

$$Z = \frac{(2\pi fL)^2}{R}$$

where Z = impedance in ohms,
L = inductance in henrys,
f = frequency in cycles,
R = resistance in ohms.

The curves illustrated in figure 22 can be applied to parallel resonance in addition to the purpose for which they are illustrated.

Reference to the impedance curve will show that the effect of adding resistance to the circuit will result in both a

broadening out and a lowering of the peak of the curve. Since the voltage of the circuit is directly proportional to the impedance, and since it is this voltage that is applied to the grid of the vacuum tube in a detector or amplifier circuit, the impedance curve must have a sharp peak in order for the circuit to be *selective*. If the curve is broadtopped in shape, both the desired signal and the interfering signals at close proximity to resonance will give nearly equal voltages on the grid of the tube, and the circuit will then be *nonselective*; i.e., it will tune broadly.

Effect of L/C Ratio In Parallel Circuits

In order that the highest possible voltage can be developed across a parallel resonant circuit, the impedance of this circuit must be very high. The impedance will be greater when the ratio of inductance-to-capacitance is great, that is, when L is large as compared with C. When the resistance of the circuit is very low, X_L will equal X_C at resonance and, of course, there are innumerable ratios of L and C that will have *equal* reactance at a given resonant frequency, exactly as is the case in a series resonant circuit. Contrasted with the necessity for a high L/C ratio for high *impedance*, the capacity for maximum *selectivity* must be *high* and the *inductance* *low*. While such a ratio will result in lower *gain*, it will offer greater *rejectivity* to signals adjacent to the resonant signal.

In practice, where a certain value of inductance is tuned by a variable capacitance over a fairly wide range in frequency, the L/C ratio will be small at the lowest frequency and large at the high-frequency end. The circuit, therefore, will have unequal selectivity at the two ends of the band of frequencies which is being tuned. At the low-frequency end of the tuning band, where the capacitance predominates, the selectivity will be greater and the gain less than at the high-frequency end, where the opposite condition holds true. Increasing the Q of the circuit (lowering the series resistance) will obviously increase *both* the selectivity and gain.

Circulating Tank Current at Resonance

The Q of a circuit has a definite bear-

ing on the circulating tank current at resonance. This tank current is very nearly the value of the line current multiplied by the circuit Q . For example: an r.f. line current of 0.050 amperes, with a circuit Q of 100, will give a circulating tank current of approximately 5 amperes. From this it can be seen that the inductance and connecting wires in a circuit with a high Q must be of very low resistance, particularly in the case of high power transmitters, if heat losses are to be held to a minimum.

Effect of Coupling on Impedance

If a parallel resonant circuit is coupled to another circuit, such as an antenna output circuit, the impedance of the parallel circuit is decreased as the coupling becomes closer. The effect of closer (tighter) coupling is the same as though an actual resistance were added to the parallel circuit. The resistance thus coupled into the tank circuit can be considered as being *reflected* from the output or load circuit to the driver circuit.

If the load across the parallel resonant tank circuit is purely resistive, just as it might be if a resistor were shunted across part of the tank inductance, the load will not disturb the resonant setting. If, on the other hand, the load is reactive, as it could be with a too-long or too-short antenna for the resonant frequency, the setting of the tank tuning condenser would have to be changed in order to restore resonance.

Tank Circuit Flywheel Effect

When the plate circuit of a class-B or class-C operated tube (defined in the following chapter) is connected to a parallel resonant circuit, the plate current serves to maintain this L/C circuit in a state of oscillation. If an initial impulse is applied across the terminals of a parallel resonant circuit, the condenser will become charged when one set of plates assumes a positive polarity, the other set a negative polarity. The condenser will then discharge through the inductance; the current thus flowing will cut across the turns of the inductance and cause a counter e.m.f. to be set up, charging the condenser in the opposite direction.

In this manner, an alternating current

is set up within the L/C circuit and the oscillation would continue indefinitely with the condenser charging, discharging and charging again if it were not for the fact that the circuit possesses some resistance. The effect of this resistance is to dissipate some energy each time the current flows from inductance to condenser and back, so that the amplitude of the oscillation grows weaker and weaker, eventually dying out completely.

The frequency of the initial oscillation is dependent upon the L/C constants of the circuit. If energy is applied in short spurts or pushes at just the right moments, the L/C circuit can be maintained in a constant oscillatory state. The plate current pulses from class-B and class-C amplifiers supply just the desired kind of kicks.

Whereas the class-B plate current pulses supply a kick for a longer period, the short pulses from the class-C amplifier give a pulse of very high amplitude, thus being even more effective in maintaining oscillation. So it is that the positive half cycle in the tank circuit will be reinforced by a plate current kick, but since the plate current of the tube only flows during a half cycle or less, the *missing* half cycle in the tank circuit must be supplied by the discharge of the *condenser*.

Since the amplitude of this half cycle will depend upon the charge on the plates of the condenser, and since this in turn will depend upon the capacitance, the value of capacitance in use is very important. Particularly is this true if a distorted wave shape is to be avoided, as would be the case when a transmitter is being modulated. The foregoing applies particularly to single-ended amplifiers. If push-pull were employed, the negative half cycle would secure an additional kick, thereby greatly lessening the necessity for the use of higher C in the L/C circuit.

Impedance Matching: Impedance, Voltage and Turns Ratio

A fundamental law of electricity is that the maximum transfer of energy results when the impedance of the load is equal to the impedance of the driver. Although this law holds true, it is not necessarily a desirable one for every condition or purpose. In many cases where a vacuum tube works into a

parallel resonant circuit load, it is desirable to have the load impedance considerably higher than the tube plate impedance, so the maximum power will be dissipated by the load rather than in the tube. On the other hand, one of the notable conditions for which the law holds true is in the matching of transmission lines to an antenna impedance.

Often a vacuum tube circuit requires that the plate impedance of a driver circuit be matched to the grid impedance of the tube being driven. When the driven tube operates in such a condition that it draws grid current, such as in all transmitter r.f. amplifier circuits, the grid impedance may well be lower than the plate tank impedance of the driver stage. In this case it becomes necessary to tap down on the driver tank coil in order to select the proper number of turns that will give the desired impedance. If the desired working load impedance of the driver stage is 10,000 ohms, for example, and if the tank coil has 20 turns, the grid impedance of the driven stage being 5,000 ohms, it is evident that there will be required a

$$\text{step-down impedance ratio of } \frac{10,000}{5,000}$$

or 2-to-1. This impedance value is *not* secured when the driver inductance is tapped at the center. It is of importance to stress the fact that the impedance is decreased *four times* when the number of turns on the tank coil is *halved*. The following equations show this fact:

$$\frac{N_1}{N_2} = \sqrt{\frac{Z_1}{Z_2}} \text{ or } \frac{N_1^2}{N_2^2} = \frac{Z_1}{Z_2},$$

where $\frac{N_1}{N_2}$ = turns ratio,

$$\frac{Z_1}{Z_2} = \text{impedance ratio}$$

In the foregoing example, a step-down impedance ratio of 2-to-1 would require a *turns* step-down ratio of the square root of the impedance or 1.41. Therefore, if the inductance has 20 turns, a tap would be taken on the 6th turn down from the hot end or 14 turns up from the cold end. This is arrived at by taking the resultant for the turns ratio, i.e., 1.41, and then dividing it into the total number of turns, as follows:

$$\frac{20}{1.41} = 14 \text{ (approx.)}$$

Either an impedance step-up or step-down ratio can be secured from a parallel resonant circuit. One popular type of antenna impedance matching device utilizes this principle. Here, however, two condensers are effectively in series across the inductance; one has quite a high capacitance (500 $\mu\text{mfd.}$), the other is a conventional size condenser used principally to restore resonance. The theory of the device is simply that the impedance is proportional to the reactances of the condensers and, by changing the ratio of the two, the antenna is effectively connected into the tank circuit at impedance points which reach higher or lower values as the ratio of the condensers is changed.

In practice, however, it is usually necessary to change the value of inductance in order to maintain resonance while still correctly matching it to the antenna or feeder. This method is discussed at greater length in *Chapter 4*.

As the impedance step-down ratio becomes larger, the voltage step-down becomes correspondingly great. Such a condition takes place when a resonant circuit is tapped down for reasons of impedance matching; the voltage will be stepped down in direct proportion to the turn step-down ratio. The reverse holds true for step-up ratios. As the step-up ratio is increased, the voltage is increased. This principle applies in the case of an *auto transformer* illustrated in figure 24.

The type of transformer in figure 24 when wound with heavy wire and over an iron core is a common device in primary power circuits for the purpose of increasing or decreasing the line voltage. In effect, it is merely a con-

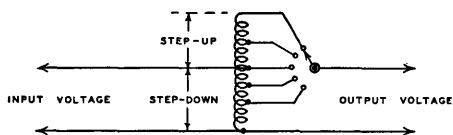

Figure 24. Illustrating design and method of connecting an auto transformer.

tinuous winding with taps taken at various points along the winding, the input voltage being applied to the bottom and also to one tap on the winding. If the output is taken from this same tap, the voltage ratio will be 1-to-1; i.e., the input voltage will be the same as the output voltage. On the other hand, if the output tap is moved down toward the common terminal, there will be a step-down in the turns ratio with a consequent step-down in voltage.

The opposite holds true if the output terminal is moved upward from the middle input terminal; there will be a voltage step-up in this case. The initial setting of the middle input tap is chosen so that the number of turns will have sufficient reactance to keep the no-load primary current at a reasonably low value.

In the same manner as voltage is stepped up and down by changing the number of turns in a winding, so can impedance be stepped up or down. Figure 25A shows an application of this prin-

ciple as applied to a vacuum tube circuit which couples one circuit to another.

Assuming that the grid impedance may be of a lower value than the plate tank impedance of the preceding stage, a step-down ratio will be necessary in order to give maximum transfer of energy. In B of figure 25, the grid impedance is very high as compared with the tank impedance of the driver stage, and thus there is required a step-up ratio to the grid. The driver plate is tapped down on its plate tank coil in order to make this impedance step-up possible. A driver tube with very low

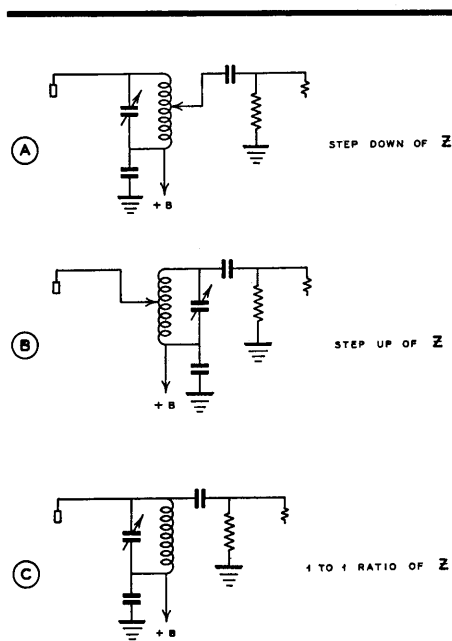

Figure 25. Impedance step-up and step-down may be obtained by utilizing the plate tank circuit of a vacuum tube as an auto transformer.

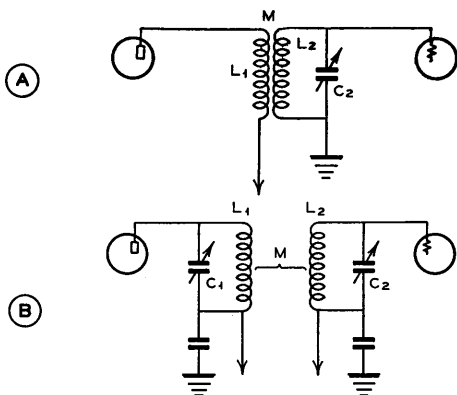

Figure 26. Two common examples of inductive coupling in radio circuits.

plate impedance must be used if a good order of plate efficiency is to be realized.

In C of figure 25, the grid impedance very closely approximates the plate impedance and this connection is used when no transformation is required. The grid and plate impedances are not generally known in many practical cases; hence, the adjustments are made on the basis of maximum grid drive consistent with maximum safe input to the driver stage.

Inductive Coupling

Inductive coupling is often used when two circuits are to be coupled. This method of coupling is shown in figures 26A and 26B.

The two inductances are placed in such inductive relation to each other that the

lines of force from the primary coil cut across the turns of the secondary coil, thereby inducing a voltage in the secondary. As in the case of capacitive coupling, impedance transformation here again becomes of importance. If two parallel tuned circuits are coupled very closely together, the circuits can in reality be overcoupled. This is illustrated by the curve in figure 27.

The dotted line curve A is the original curve or that of the primary coil alone. Curve B shows what takes place when two circuits are overcoupled; the reso-

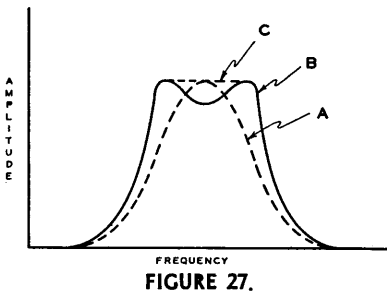

FIGURE 27.

nance curve will have a definite dip on the peak, or a double hump. This principle of overcoupling is advantageously utilized in bandpass circuits where, as shown in C, the coupling is adjusted to such a value as to reduce the peak of the curve to a virtual flat top, with no dip in the center as in B.

Some undesirable capacitive coupling will result when circuits are closely or tightly coupled; if this capacitive coupling is appreciable, the tuning of the circuits will be affected. The amount of capacitive coupling can be reduced by so arranging the physical shape of the inductances as to enable only a minimum surface of one to be presented to the other.

Another method of accomplishing the same purpose is by electrical means. A curtain of closely-spaced parallel wires or bars, connected together only at one end, and with this end connected to ground, will allow electromagnetic coupling but not electrostatic coupling. Such a device is called a *Faraday screen* or *shield*.

Link Coupling

Still another method of decreasing

capacitive coupling is by means of a *coupling link* circuit between two parallel resonant circuits. The capacity of the coupling link, with its one or two turns, is so small as to be negligible.

Link coupling is widely used in transmitter circuits because it adapts itself so universally and eliminates the need of a radio-frequency choke, thereby reducing a source of loss. Link coupling is very simple; it is diagrammed in A and B of figure 28.

In A of figure 28, there is an impedance step-down from the primary coil to the link circuit. This means that the line which connects the two links or loops will have a low impedance and therefore can be carried over a considerable distance without introduction of appreciable loss. A similar link or loop is at the output end of the line; this loop is coupled to the grid tank of the driven stage.

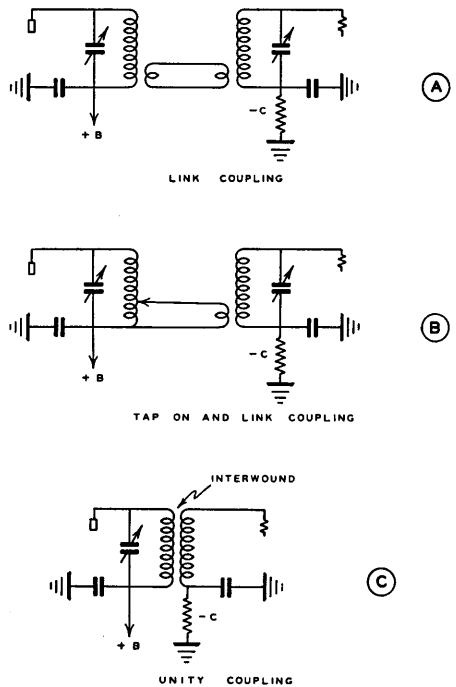

Figure 28. Two types of link (inductive) coupling and below, unity coupling.

Still another link coupling method is shown in B of figure 28. It is similar to that of A, with the exception that the primary line is tapped on the coil, rather than being terminated in a link or loop.

Unity Coupling

Another commonly used type of coupling is that known as *unity coupling*, by reason of the fact that the turns ratio between primary and secondary is one-to-one. This method of coupling is illustrated in C of figure 28. Only one of the windings is tuned although the interwinding of the two coils gives an effect in the untuned winding as though it were actually tuned with a condenser.

Unity coupling is used in some types of ultra-high frequency circuits although the mechanical considerations are somewhat difficult. The secondary, when it serves as the grid coil, is placed inside of a copper tubing coil; the latter serves as the primary or plate coil.

Transformer Action; Reflected Impedance

Two inductances coupled to each other constitute a transformer in basic form. The two inductances can be wound on separate air core forms, or, as in an audio or power transformer, on iron or magnetic cores. Power transformers are treated in a separate chapter of this *Handbook*; radio-frequency transformers have already been treated; thus, this discussion will be confined to audio-frequency transformers.

In all audio-frequency circuit applications, it is only necessary to refer to the *tube tables* in this book in order to find the recommended load impedance for a given tube and a given set of operating conditions. For example, the table shows that a type 42 pentode tube requires a load impedance of 7,000 ohms. Audio transformers are always rated for both their primary and secondary impedance, which means that the primary impedance will be of the rated value *only* when the secondary is terminated in its rated impedance.

If a 7,000-ohm plate load is to work into a 7-ohm loudspeaker voice coil, the impedance ratio of the transformer would be $\frac{7,000}{7} = 1,000\text{-to-1}$. Hence, the

turns-ratio will be the square root of 1,000 or 31.6. This does not mean that the primary will have only 31.6 turns of wire and only one turn on the secondary. The primary must have a certain *inductance* in order to offer a high impedance to the lower audio frequencies.

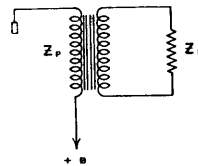

Figure 29. The reflected impedance Z_P varies directly in proportion to Z_L and the square of the turns ratio.

Consequently, it must have a large number of turns of wire in the primary winding. The *ratio* of total primary turns to total secondary turns must remain constant, regardless of the number of turns in the primary if the correct primary impedance is to be maintained.

To summarize, a certain transformer will have a certain impedance ratio (determined by the square of the turns ratio) which will remain constant. If the transformer is terminated with an impedance or resistance *lower* than the original rated value, the reflected impedance on the primary will also be lower than the rated value. If the transformer is terminated in an impedance *higher* than rated, the reflected primary impedance will be higher.

For push-pull amplifiers the recommended primary impedance is stated as some certain value, *plate to plate*; this refers to the impedance of the total winding without consideration of the center tap. The reflected impedance across the total primary will follow the same rules as previously given for single-ended stages. The voltage relationship in primary and secondary is the same as the turns ratio. For a step-down turns ratio of 10-to-1, the corresponding *voltage* step-down would be 10-to-1 though the *impedance* ratio would be 100-to-1.

CHAPTER 2

Vacuum Tube Theory and Practice

Thermionic Effect—Tube Types and Applications—Circuits and Characteristics—Class-A, AB, B and C Amplifiers

VACUUM TUBES are widely used for the generation, detection and amplification of audio- and radio-frequency currents; electron tubes also serve as power rectifiers to convert alternating current into direct current and, in special cases, for controlling and converting electric power.

The performance of a thermionic tube depends upon the emission of electrons from a metallic surface and the flow of these electrons to other surfaces; the transition constitutes an electric current.

An electron tube consists essentially of an evacuated glass or metal envelope in which is enclosed an electron emitting surface, called a *cathode*, and one or more additional electrodes. The connections for the various elements are carried through the tube envelope to special connectors.

Electron Emission; Cathodes

The rate of electronic motion in every atom increases if the molecular constituents of any material are subjected to thermal agitation. Hence, by heating certain metallic conductors, the motion of electrons becomes so rapid that some of them break away from their parent atoms and are set free in space. In the absence of any external attraction, the electrons escaping from the emissive surface repel each other because they are all negatively charged. Therefore, the number of electrons leaving the emitter is limited because the free negatively-charged electrons counteract the escape function of new electrons.

The point of electronic saturation is called the *space charge effect*. When this condition is reached, no further electrons

will leave the emitter regardless of how much higher the temperature of the emitting surface is increased.

In most all modern vacuum tubes, the surface of the cathode material is chemically treated in order to increase electronic emission. The two principal types of surface treatment include thoriated tungsten filaments, as used in medium- and high-powered transmitter tubes, and oxide coated filaments or cathode sleeves, such as used in most receiver tubes. Pure tungsten filaments are practically obsolete, and are only being manufactured for some types of high-power transmitter tubes in which sufficient vacuum cannot be maintained for operating properly a thoriated tungsten type of filament.

Cathode Current

When a heated cathode and a separate metallic plate are placed in an evacuated envelope, it is found that a few of the electrons thrown off by the cathode will leave with sufficient velocity to reach the plate. If the plate is electrically connected back to the cathode, the electrons will flow from cathode to plate and through the external circuit back to cathode, due to the potential difference between plate and cathode. This small current flow is called *plate current*.

If a battery or other source of d.c. voltage is placed in the external circuit between the plate and cathode so that the battery voltage places a positive potential on the plate, the flow of current from the cathode to plate will be increased. This is due to the strong attraction offered by the positively charged plate for any negatively charged elec-

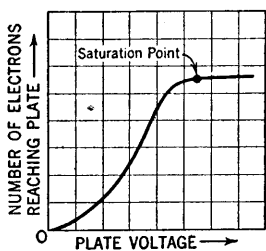

Figure 1. Curve showing emission from a cathode.

trons. If the positive potential on the plate is increased, the flow of electrons between the cathode and plate will also increase up to the point of *saturation*. Saturation current flows when all of the electrons leaving the cathode are attracted to the plate, and no increase in plate voltage can increase the number of electrons being attracted to the plate.

Operating a cathode at a temperature materially above its normal rating will shorten the life of the emitting surface. In the case of thoriated tungsten emitters, which are rather sensitive to changes in filament temperature, it is advisable to have a close control over the filament voltage. If there is doubt about the filament voltage, it is better to operate the filament slightly higher than normal rather than below normal, especially if the tube is operating with high plate current.

Rectification

It has been stated that when the potential of the plate is different from that of the cathode, electrons will be attracted to the plate and a current will flow in the external circuit. If, on the other hand, the plate is made negative, the electron flow in the external circuit will cease due to the repulsion of the electron stream within the tube back to its cathode. From this is derived a valuable property, namely, the ability to pass current in one direction only as in a *rectifier*. Figure 2A shows a half-wave rectifier circuit. For convenience of explanation, a conventional power rectifier is chosen although the same diagram and explanation will apply to diode rectification in a radio receiver.

When a sine wave voltage is induced in the secondary of the transformer, the

rectifier plate is made alternately positive and negative as the polarity of the alternating-current changes. Electrons are attracted to the plate from the cathode when the plate is positive, and current then flows in the external circuit. On the succeeding half cycle, the plate becomes negative with respect to the cathode, and no current flows. Thus, there will be an interval before the succeeding half cycle occurs when the plate again becomes positive. Under these conditions, plate current once more begins to flow and there is another pulsation in the output circuit.

For the reason that one half of the complete wave is absent in the output, the result is what is known as *half-wave rectification*. The output power is the average value of these pulsations; it will, therefore, be of a low value because of the interval between pulsations.

In a *full-wave* circuit (figure 2B), the plate of one tube is positive when the other plate is negative; although the current changes its polarity, one of the plates is always positive. One tube, therefore, operates effectively on each half cycle, but the output current is in the same direction. In this type of circuit the rectification is complete and there is no gap between plate current pulsations. This output is known as *rectified a.c.* or *pulsating d.c.*

Mercury Vapor Rectifiers

If a two-element electron tube is evacuated and then filled with a gas such

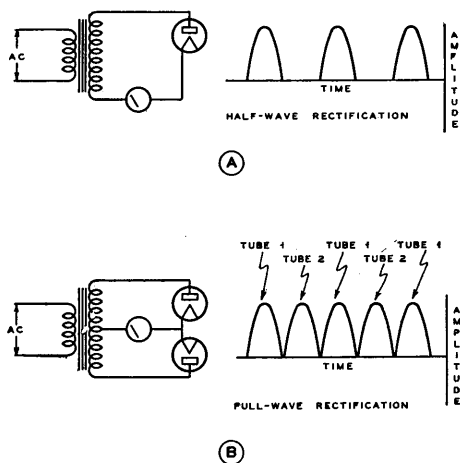

FIGURE 2.

as mercury vapor, its characteristics and performance will differ radically from that of an ordinary high-vacuum diode tube.

The principle upon which the operation of a gas-filled rectifier depends is known as the phenomenon of *ionization*. Investigation has shown that the electrons emitted by a hot cathode in a mercury vapor tube are accelerated toward the anode (plate) with great velocity. These electrons move in the electrical force-free space between the hot cathode and the anode in which space they collide with mercury vapor molecules.

If the moving electrons attain a velocity so great as to enable them to break through a potential difference of more than 10.4 volts (for mercury), they will literally knock the electrons out of the atoms with which they collide.

As more and more atoms are broken up by collision with electrons, the mercury vapor within the tube becomes *ionized* and transmits a considerable amount of current. The ions are repelled from the anode when it is positive; they are then attracted to the cathode, thus tending to neutralize the negative space charge as long as saturation current is not drawn. This effect neutralizes the negative space charge to such a degree that the resistance of the tube is reduced to a very low value; furthermore, the reduction in heating of the diode plate, as well as an improvement in the voltage regulation of the load current, is achieved. The efficiency of rectification is thereby increased because the voltage drop across any rectifier tube represents a waste of power.

Vacuum Tube As An Amplifier

A rectifier tube is essentially a two-element device. A third element can be added to the tube as a means of controlling the plate current. A third element of this type is called a *grid*. It is a mesh-like structure which surrounds the cathode, interposed between cathode and plate in such a manner that the passage of electrons to the plate must travel through the grid on the way.

If this grid is made negative with respect to the cathode, the negatively-charged electrons will be repelled back to the cathode. Plate current can be stopped entirely when the grid is made

sufficiently negative, even though there is a positive voltage on the plate that would ordinarily attract electrons. Thus, it can be seen that the grid acts as a valve in its control of the plate current; it is for this reason that vacuum tubes are termed valves in Britain, Australia and Canada. When there is less negative voltage on the grid than that necessary to cut off the plate current, a steady value of plate current will flow. The value of fixed negative voltage on the grid of a vacuum tube is referred to as *bias*.

A graph of values of plate current for various values of grid voltage can be plotted as shown in figure 3.

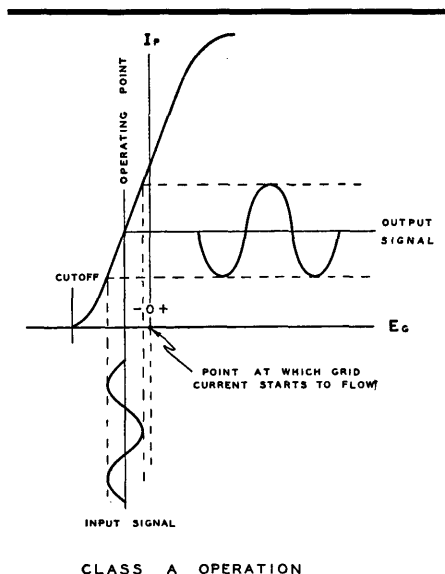

FIGURE 3.

A suitable operating point is chosen on the static characteristic curve; this point is dictated by the service to which the tube is to be subjected. The bias determines the operating point, and a signal causes the grid to vary back and forth about this point in exact accordance with the wave shape of the input signal. This is the condition under which a class-A amplifier functions. The fluctuation in grid potential results in a corresponding fluctuation in plate current. When this current flows through a suitable load device, it produces a

varying voltage drop which is a replica of the original input voltage, although considerably greater in amplitude.

Amplification Factor; Mutual Conductance; Plate Resistance

The amplification factor or mu (μ) of a vacuum tube is the ratio of a change in plate voltage to a change in grid voltage, either of which will cause the same change in plate current. Expressed as a differential equation:

$$\mu = \frac{dE_p}{dE_g}$$

The μ can be determined experimentally by making a slight change in the plate voltage, thus slightly changing the plate current. The plate current is then returned to its original value by a change in grid voltage. The ratio of the increment in plate voltage to the increment in grid voltage is the μ of the tube. The foregoing assumes that the experiment is conducted on the basis of rated voltages as shown in the manufacturers' tube tables.

The plate resistance can also be determined by the previous experiment. By noting the change in plate current as it occurs when the plate voltage is changed, and by dividing the latter by the former, the plate resistance can then be determined. Expressed as an equation:

$$R_p = \frac{dE_p}{dI_p}$$

The mutual conductance, also referred to as *transconductance*, is the ratio of the amplification factor (μ) to the plate resistance:

$$S_m = \frac{\mu}{R_p} = \frac{\frac{dE_p}{dE_g}}{\frac{dE_p}{dI_p}} = \frac{dI_p}{dE_g}$$

The amplification factor is the ability of the tube to amplify or increase the voltages applied to the grid. The amount of voltage amplification that can be obtained from a tube is expressed as follows:

$$\frac{\mu R_L}{R_p + R_L}$$

where R_L = ohmic load in the plate circuit. In the case of a type 6F5 tube with a plate resistor of 50,000 ohms, the voltage amplification as calculated from the previous equation would be:

$$\frac{100 \times 50,000}{50,000 + 66,000} = 43$$

From the foregoing, it is seen that an input of 1 volt to the grid of the tube will give an output of 43 volts (a.c.).

Class-A Amplifier

The expression, class-A, is simply a means of classifying the operating conditions of an amplifier stage. It was previously explained how the fixed bias applied to the grid of an amplifier determines the operating point from which the signal input varies. From the characteristic curve in figure 3, it will be seen that this curve is not a perfectly straight line, but is curved toward its base with an additional curvature at the top due to filament saturation. If an amplifier is to be designed so that it will faithfully reproduce the character of the input signal, the operating point on the curve must be set in the center of the straight line portion. Furthermore, the amplitude of the input signal must be such that the peaks do not exceed the straight line portion of the characteristic curve.

Should the signal be permitted to go too far negative, the negative half cycle in the plate output will not be the same as the positive half cycle. In other words, the output wave shape will not be a duplicate of the input, and *distortion* in the output will therefore result. The fundamental property of class-A amplification is that the bias voltage and input signal level must not advance beyond the point of zero grid potential; otherwise, the grid itself will become positive. Electrons will then flow into the grid and through its external circuit in much the same manner as if the grid were actually the plate. The result of such a flow of grid current is a lowering of the input impedance of the tube so that power is required to drive it.

Class-A amplifiers are never designed to draw grid current; in other words, the grid is never permitted to become positive. Class-A amplifiers do not realize the optimum capabilities of any

individual tube; it can, therefore, be said that the efficiency of such amplifiers is low. They are used because they give very little distortion, even though larger tubes and higher plate voltage are required to obtain a given audio output power than when some grid current is permitted to flow. The correct bias for class-A operation is given in the *Tube Tables*.

Load Impedance; Dynamic Characteristic

The plate current in an amplifier increases and decreases in proportion to the value of applied input signal. If useful power is to be realized from such an amplifier, the plate circuit must be terminated in a suitable resistance or impedance across which the power can be developed. When increasing and decreasing plate current flows through a resistor or impedance, the voltage drop across this load will constantly change because the plate current is constantly changing. The actual value of voltage on the plate will vary in accordance with the IZ drop across the load, even though a steady value of direct current may be applied to the load impedance; hence, for an alternating voltage on the grid of the tube, there will be a constant change in the voltage at the anode.

The static characteristic curves give an indication of the performance of the tube for only one value of plate voltage. If the plate voltage is changed, the characteristic curve will shift. This sequence of change can be plotted in a form that permits a determination of tube performance; it is customary to plot the plate current for a series of permissible values of plate voltage at some fixed value of grid voltage. The process is repeated for a sufficient number of grid voltage values in order that adequate data will be available. A group or family of plate voltage-plate current curves, each for a different grid potential, makes possible the calculation of the correct load impedance for the tube. Dynamic characteristics include curves for variations in amplification factor, plate resistance, transconductance and detector characteristics.

The correct value of load impedance for a rated power output is always specified by the tube manufacturer. The

plate coupling device generally reflects this impedance to the tube. This subject was treated under *Impedance Matching*.

Tubes in Parallel and Push-Pull

Two or more tubes can be connected in parallel in order to secure greater power output; two tubes in parallel will give twice the output of a single tube. Since the plate resistances of the two tubes are in parallel, the required load impedance will be half that for a single tube.

When power is to be increased by the use of two tubes, it is generally advisable to connect them in push-pull; in this connection the power output is doubled and the *harmonic content*, or *distortion*, is reduced. The input voltage applied to the grids of two tubes is 180 degrees out of phase, the voltage usually being secured from a center-tapped secondary winding with the center tap connected to the source of bias and the outer ends of the winding connected to each grid. The plates are similarly fed into a center-tapped winding and plate voltage is introduced at the center tap. The signal voltage supplied to one grid must always swing in a positive direction when the other grid swings negatively. The result is an increase in plate current in one tube with a decrease in plate current in the other at any given instant; one tube *pushes* as the other *pulls*; hence the term: *push-pull*.

Voltage and Power Amplification

Practically all amplifiers can be divided into two classifications, *voltage amplifiers* and *power amplifiers*. In a voltage amplifier, it is desirable to increase the voltage to a maximum possible value, consistent with allowable distortion. The tube is not required to furnish *power* because the succeeding tube is always biased to the point where no grid current flows. The selection of a tube for voltage amplifier service depends upon the voltage amplification it must provide, upon the load that is to be used and upon the available value of plate voltage. The varying signal current in the plate circuit of a voltage amplifier is employed in the plate load solely in the production of *voltage* to be applied to the grid of the following stage. The plate voltage is always relatively high, the plate current small.

A power amplifier, in contrast, must be capable of supplying a heavy current into a load impedance that usually lies between 2,000 and 10,000 ohms. Power amplifiers normally furnish excitation to power-consuming devices such as a loud-speaker or antenna. They also serve as

drivers for other larger amplifier stages whose grids require power from the preceding stage. Power amplifiers are common in transmitters.

The difference between the plate power input and output is dissipated in the tube in the form of heat, and is known as the *plate dissipation*. Tubes for power amplifier service have larger plates and heavier filaments than those for a voltage amplifier. High-power audio circuits for commercial broadcast transmitters call for tubes of such proportions that it becomes necessary to cool their plates by means of water jackets or air-cooling systems.

Interstage Coupling

Common methods of coupling one stage to another are shown in figure 4.

Transformer coupling for a single-ended stage is shown in A; coupling to a *push-pull* stage in B; *resistance coupling* in C; *impedance coupling* in D. A combination impedance-transformer coupling system is shown in E; this arrangement is generally chosen for high permeability audio transformers of small size and where it is necessary to prevent the plate current from flowing through the transformer primary. The plate circuit in the latter is *shunt-fed*.

Class-AB Amplifier

In a class-AB amplifier, the fixed grid bias is made higher than would be the case for a push-pull class-A amplifier. The resting plate current is thereby reduced and higher values of plate voltage can be used without exceeding the rated plate dissipation of the tube. The result is an increase in power output.

Class-AB amplifiers can be subdivided into class-AB₁ and class-AB₂. There is no flow of grid current in a class-AB₁ amplifier; that is, the peak signal voltage applied to each grid does not exceed the negative grid bias voltage. In a class-AB₂ amplifier the grid signal is greater than the bias voltage on the peaks and grid current flows.

The class-AB amplifier should be operated in push-pull if distortion is to be held to a minimum. Class-AB₂ will furnish more power output for a given pair of tubes than will class-AB₁. The grids of a class-AB₂ amplifier draw current, which calls for a power driver stage.

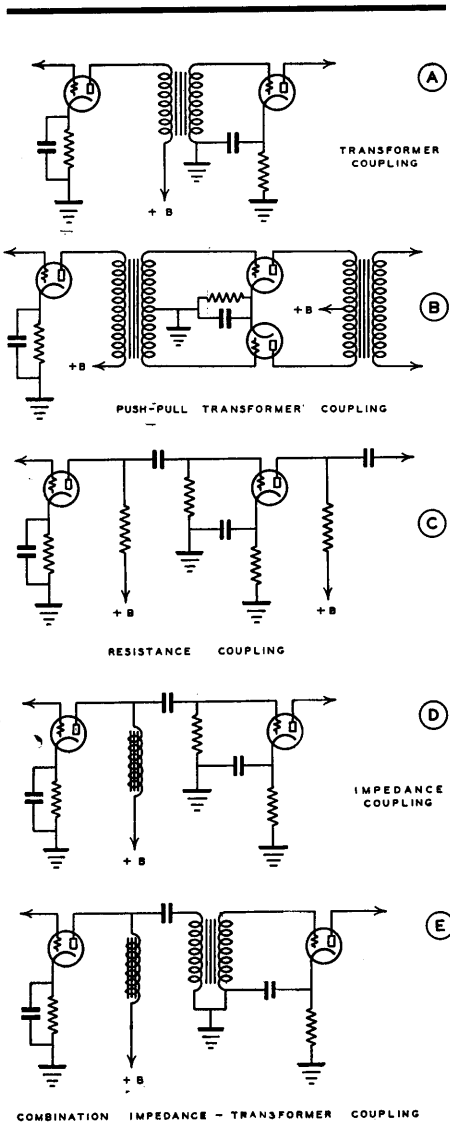

Figure 4. Five common methods of a.f. interstage coupling.

Class-B Amplifier

A class-B audio amplifier operates with two tubes in push-pull. The bias voltage is increased to the point where but very little plate current flows. This point is called the *cut-off point*. When the grids are fed with voltage 180 degrees out of phase, that is one grid swinging in a positive direction and the other in a negative direction, the two tubes will alternately supply current to the load. When the grid of tube no. 1 swings in a positive direction, plate current flows in this tube. During this process, grid no. 2 swings negatively beyond the point of cut off; hence, no current flows in tube no. 2. On the other half-cycle tube, no. 1 is idle, and tube no. 2 furnishes current. Each tube operates on one-half cycle of the input voltage so that the complete input wave is reproduced in the plate circuit. Since the plate current rests at a very low value when no signal is applied, the plate efficiency is considerably higher than in an A amplifier.

There is a much higher steady value of plate current flow in a class-A amplifier, regardless of whether or not a signal is present. The average plate dissipation or plate loss is much greater than in a B amplifier of the same power output capability.

For the reason that the plate current rises from a low to a very high peak value on input swings in a class-B audio amplifier, the demands upon the power supply are quite severe; a power supply for class-B amplifier service must have good *regulation*. A high-capacity output condenser must be used in the filter circuit to give sufficient storage to supply power for the stronger audio peaks, and a choke-input filter system is required for good regulation.

Radio-Frequency Amplifier

Class-B radio-frequency amplifiers are used primarily as *linear amplifiers* whose function is to increase the output from a modulated class-C stage. The bias is adjusted to the cut-off value. In a single-ended stage, the r.f. plate current flows on alternate half cycles. The power output in class-B r.f. amplifiers is proportional to the square of the grid excitation voltage. The grid voltage excitation is doubled in a linear amplifier at 100% modulation, the grid excitation voltage being supplied by the modulated stage;

hence, the power output on modulation peaks in a linear stage is increased four times in value. In spite of the fact that power is supplied to the tank circuit only on alternate half cycles, the flywheel effect of the tuned tank circuit supplies the missing half cycle of radio frequency, and the complete wave form is reproduced in the output to the antenna.

Class-C R. F. Amplifier

The class-C amplifier differs from others in that the bias voltage is increased to a point well beyond cut off. When a tube is biased to cut off as in a class-B amplifier, it draws plate current for a half cycle or 180°. As this point of operation is carried beyond cut off, that is, when the grid bias becomes more negative, the angle of plate current flow decreases. Under normal conditions, the optimum value for class-C amplifier operation is approximately 120°. The plate current is at zero value during the first 30° because the grid voltage is still approaching cut off. From 30° to 90°, the grid voltage has advanced beyond cut off and swings to a maximum in a region which allows plate current to flow. From 90° to 150°, the grid voltage returns to cut off, and the plate

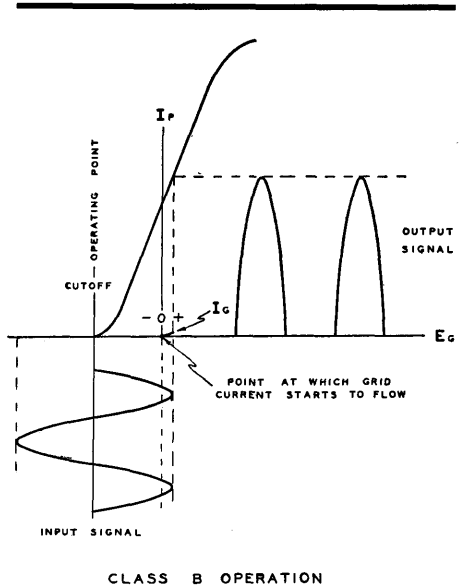

FIGURE 5.

current decreases to zero. From 150° to 180° , no plate current flows since the grid voltage is then beyond cut off.

The plate current in a class-C amplifier flows in pulses of high amplitude, but of short duration. Efficiencies up to 75% are realized under these conditions. It is possible to convert nearly all of the plate input power into r.f. output power (approximately 90% efficiency) by increasing the excitation, plate voltage and bias to extreme values.

The r.f. plate current is proportional to the plate voltage; hence, the power output is proportional to the square of the plate voltage. Class-C amplifiers are invariably used for plate modulation because of their high efficiency and because they reflect a pure resistance load into the modulator. The plate voltage of the class-C stage is doubled on the peaks at 100% modulation; the power output at this point is consequently increased four times.

Oscillation

The ability of an amplifier tube to control power enables it to function as an oscillator in a suitable circuit. When part

of the amplified output is coupled back into the input circuit, sustained oscillations will be generated provided the input voltage to the grid is of the proper magnitude and phase with respect to the plate.

The voltage that is fed back and applied to the grid must be 180° out of phase with the voltage across the load impedance in the plate circuit. The voltage swings are of a frequency depending upon circuit constants.

If a parallel resonant circuit consisting of an inductance and a capacitance is inserted in series with the plate circuit of an amplifier tube and a connection is made so that part of the potential drop is impressed on the grid of the same tube 180° out of phase, amplification of the potential across the L/C circuit will result. The potential would increase to an unrestricted value were it not for the limited plate voltage and the limited range of linearity of the tube characteristic, which causes a reversal of the process after a certain point is reached. The rate of reversal is determined by the time constant or resonant frequency of the tank circuit.

The frequency range of an oscillator

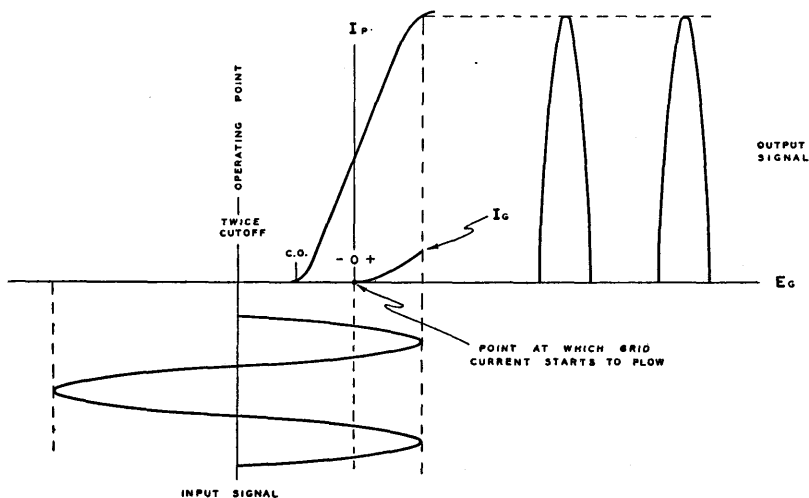

CLASS C OPERATION

FIGURE 6.

can be made very great; thus, by varying the circuit constants, oscillations from a few cycles per second up to many millions can be generated. A number of different types of oscillators are treated in detail elsewhere in this *Handbook*.

Harmonic Distortion

Distortion exists when the output wave shape of an amplifier departs from the shape of the input voltage wave. The flywheel effect in an r.f. amplifier tends literally to iron out the irregularities in the plate circuit wave, but, unless the ratio of capacitance is high as compared to the value of inductance, the foregoing does not hold entirely true. Distortion is present in the form of *harmonics*, which are voltages existing simultaneously with the fundamental at frequencies 2, 3, 4, 5, etc. times this fundamental frequency.

The lower order of harmonics, namely, those whose frequencies are twice and three times that of the fundamental frequency, are generally the strongest. The presence of strong harmonics in an audio-frequency amplifier gives rise to speech or music distortion plainly apparent to the human ear. The average ear can tolerate a certain amount of distortion, and audio amplifiers are, therefore, rated in percentage of *harmonic content*. The value of 5% is generally accepted as being the maximum permissible total harmonic distortion from an average audio amplifier.

The effect of harmonics in a c.w. telegraph transmitter is objectionable, for the reason that frequencies in addition to those for the desired transmission may be radiated if means are not taken to suppress them or keep them from reaching the antenna. This is covered in *Chapter 4*.

Detection

Detection is the process by which the audio component is separated from the modulated radio-frequency signal carrier at the receiver. Detection always involves either rectification or nonlinear amplification of an alternating current.

Two general types of amplifying detectors are used in radio circuits:

(1) *Plate Detector*. The plate detector or *bias detector* (sometimes called a *power detector*) amplifies the radio-frequency wave and then rectifies it and passes the resultant audio signal com-

ponent to the succeeding audio amplifier. The detector operates on the lower bend in the plate current characteristic, because it is biased close to the cut-off point and therefore could be called a single-ended class-B amplifier. The plate current is quite low in the absence of a signal and the audio component is evidenced by an increase in the average unmodulated plate current. See figure 7.

(2) *Grid Detector*. The grid detector differs from the plate detector in that it rectifies in the grid circuit and then amplifies the resultant audio signal. The only source of grid bias is the grid leak so that the plate current is maximum when no signal is present. This form of detector operates on the upper or saturated bend of its characteristic curve, at a high plate voltage, and the demodulated signal appears as an audio-frequency decrease in the average plate current. However, at low plate voltage, most of the rectification takes place as the result of the *curvature* in the grid characteristic. By proper choice of grid leak and plate voltage, distortion can be held to a reasonably small value. In extreme cases the distortion can reach a very high value, particularly when the carrier signal is modulated to a high percentage. In such cases the distortion can reach 25%.

The grid detector will absorb some power from the preceding stage because it draws grid current. It is significant to relate that the higher gain through the grid detector does not necessarily indicate that it is more sensitive. Detector sensitivity is a matter of *rectification efficiency* and amplification, not amplification alone. Grid leak detectors are often used in regenerative detector circuits because smoother control of *regeneration* is possible than in other forms of plate and bias detectors.

Tetrodes

When still another grid is added to a vacuum tube between the control grid and plate, the tube is then called a *tetrode*, meaning that it has four elements. Such tubes are more familiarly known as *screen grid* tubes since the additional element is called a *screen*. The interposition of this screen between grid and plate serves as an electrostatic shield between these two elements, with the consequence that the grid-to-plate capac-

itance is reduced. This effect is accomplished by establishing the screen at r.f. ground potential by by-passing it to ground with a fairly large condenser. The grid-plate capacitance is then so small that the amount of feed-back voltage from plate to grid is normally insufficient to start oscillation. The ad-

vent of the screen grid tube eliminated the necessity for lossers and neutralization previously required to prevent a triode r.f. amplifier stage from oscillating.

In addition to the shielding effect, the screen grid serves another very useful purpose. Since the screen is maintained at a positive potential, it serves to increase or accelerate the flow of electrons to the plate. There being large openings in the screen mesh, most of the electrons pass through it and on to the plate. Due also to the screen, the plate current is largely independent of plate voltage, thus making for high amplification. When the screen is held at a constant value, it is possible to make radical changes in plate voltage without appreciably affecting the plate current.

Secondary Emission; Pentodes

When the electrons from the cathode travel with sufficient velocity, they dislodge electrons upon striking the plate. This effect of *bombarding* the plate with high velocity electrons, with the consequent dislodgment of other electrons from the plate, is known as *secondary emission*. This effect can cause no particular difficulty in a triode tube because the secondary electrons so emitted are eventually attracted back to the plate. In the screen grid tube, however, the screen is close to the plate and is maintained at a positive potential. Thus, the screen will attract these electrons that have been knocked from the plate, particularly when the plate voltage falls to a lower value than the screen voltage, with the result that the plate current is lowered and the amplification is decreased.

This effect is eliminated when still another element is added between the screen and plate. This additional element is called a *suppressor*, and tubes in which it is used are called *pentodes*. The suppressor grid is sometimes connected to cathode within the tube, sometimes it is brought out to a connecting pin on the tube base, but in any case it is established negative with respect to the minimum plate voltage. The secondary electrons that would travel to the screen, if there were no suppressor, are diverted back to the plate. The plate current is, therefore, not reduced and the amplification possibilities are increased.

Pentodes for audio applications are

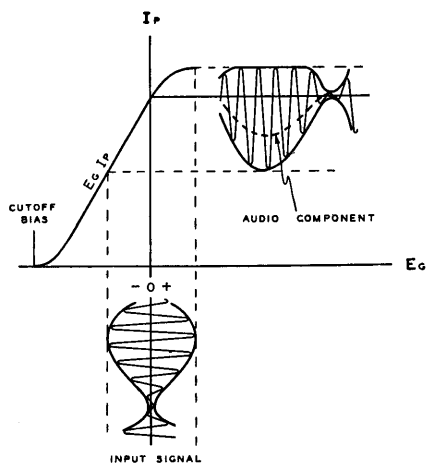

A - GRID DETECTION

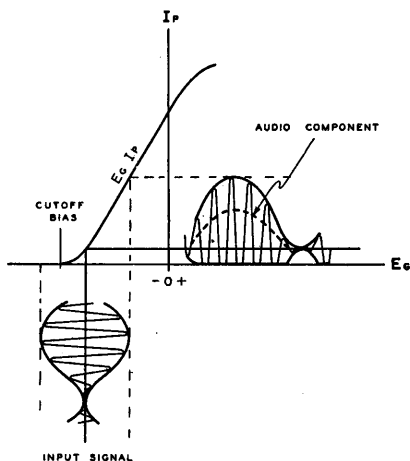

B - PLATE DETECTION

FIGURE 7.

designed so that the suppressor increases the limits to which the plate voltage may swing; therefore the consequent power output and gain can be very great. Pentodes for radio-frequency service function in such a manner that the suppressor allows high voltage gain, at the same time permitting fairly high gain at low plate voltage. This holds true even if the plate voltage is the same or slightly lower than the screen voltage.

Beam Power Tubes

A beam power tube makes use of a new method for suppressing secondary emission. In this tube there are four electrodes: a cathode, a grid, a screen and a plate, so spaced and placed that secondary emission from the plate is suppressed without actual power. Because of the manner in which the electrodes are spaced, the electrons which

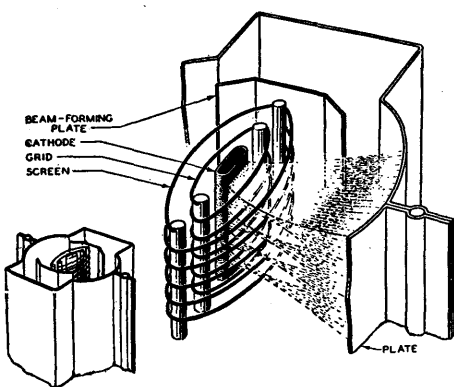

Figure 8. Internal structure of beam power tube. (Courtesy R.C.A. Radiotron.)

travel to the plate are slowed down when the plate voltage is low, almost to zero velocity in a certain region between screen and plate. For this reason the electrons form a stationary cloud, a *space charge*. The effect of this space charge is to repel secondary electrons emitted from the plate and thus cause them to return to the plate. In this way, secondary emission is suppressed.

Another feature of the beam power tube is the low current drawn by the screen. The screen and the grid are

spiral wires wound so that each turn in the screen is shaded from the cathode by a grid turn. This alignment of the screen and the grid causes the electrons to travel in sheets between the turns of the screen so that very few of them flow to the screen. Because of the effective suppressor action provided by the space charge, and because of the low current drawn by the screen, the beam power tube has the advantages of high power output, high power sensitivity and high efficiency. The 6L6 is such a beam power tube.

Pentagrid Converters

A pentagrid converter is a multiple grid tube so designed that the functions of superheterodyne oscillator and mixer are combined in one tube. One of the principal advantages of this type of tube in superheterodyne circuits is that the coupling between oscillator and mixer is automatically done; the oscillator elements effectively modulate the electron stream and, in so doing, the conversion conductance is high. The principal disadvantage of these tubes lies in the fact that they are not particularly suited for operation at frequencies much above 20 Mc. because of difficulties encountered in the oscillator section.

Special Tube Types; Twin Triodes; Frequency Converters

Some of the commonly known vacuum tubes are in reality two tubes in one, i.e., in a single glass or metal envelope. Twin triodes, such as the types 53, 6A6 and 6N7, are typical examples. A feature of the twin triode tube is its common cathode.

Of a different nature are the 6H6 twin diode and 6C8-G twin triode tubes; the cathode is a separate element in these tubes, thus making them true dual-tubes in one envelope. Other types combine the functions of double diode and triode in a common envelope, as well as a similar combination with a pentode section instead of a triode. Still other types offer a triode and a pentode in a common envelope.

Notable among the special purpose multiple grid tubes is the 6L7 heptode, used principally as a mixer in superheterodyne circuits. This tube has *five* grids: control grid, screens, suppressor

and special injection grid for oscillator input. Oscillator coupling to control grid and screen grid circuits of ordinary pentodes is effective as far as mixing is concerned, but has the disadvantage of considerable interaction between oscillator and mixer. Oscillator injection into the suppressor grid of an ordinary pentode also is not particularly successful.

The 6L7 has a special *injection grid* so placed that it has reasonable effect on the electron stream without the disadvantage of interaction between the screen and control grid. The principal disadvantage is that it requires fairly high oscillator input in order to realize its high conversion conductance. It may also be used as an r.f. pentode amplifier.

The 6J8-G and 6K8 are two tubes designed for converter service. They consist of a heptode mixer unit and a triode unit in the same envelope, internally connected to provide the proper injection for conversion work. While both tubes function as a triode oscillator feeding a heptode mixer, the method of

injection is different in the two tubes. In the 6J8-G, the control grid of the oscillator is connected internally to a special shielded injector grid in the heptode section. In the 6K8, the control grid of the heptode is connected internally to the control grid of the oscillator triode.

Conversion Transconductance

Conversion transconductance is a term applied to mixer circuits in superheterodyne receivers and may be considered as a *factor of merit* for such stages.

Tube Manuals

The larger tube manufacturers offer at a nominal cost tube manuals which are very complete and give much valuable data which, because of space limitations, cannot be included in this handbook. Those especially interested in vacuum tubes are urged to purchase one of these books as a supplementary reference.



CHAPTER 3

Decibels and Logarithms

Expression of Gain or Loss in Decibels—Amplifier and Microphone Ratings—Conversions

THE *DECIBEL* unit as used in radio engineering and virtually universal in all power and energy measurements is actually a unit of amplification expressed as a common logarithm of a power or energy ratio. One decibel is 1/10th of a bel. One bel or 10 decibels indicate an amplification by 10, the common logarithm of 10 being 1. Similarly, 2 bels or 20 db mean amplification by 100; 30 db mean amplification by 1,000, and so on. The power ratio for one decibel is expressed as

$$\frac{P_1}{P_2} = 10^{0.1} \quad (1)$$

where P_1 is the power input; P_2 , the power output. The number of decibels represents a power gain or loss, depending upon whether the relation P_1/P_2 is greater or less than 1.

Expressions for various power ratios are now commonly employed in communication engineering at audio and at radio frequencies. To express a ratio between any two amounts of power, it is convenient to use a logarithmic scale. A table of logarithms facilitates making conversions in positive or negative directions between the number of decibels and the corresponding power, voltage and current ratios.

Logarithmic Table

The table of logarithms presented here does not differ essentially from any other similar table except that no proportional parts are given and the figures are stated to only three decimal places; this arrangement does not permit great accuracy but has been found to be satisfactory for all practical radio purposes. A complete exposition on logarithms is

outside the scope of this *Handbook*; however, the very essentials together with the practical use of the tables and their application to decibels are given herewith. The following discussion is not concerned with the study of logarithms other than their direct employment to decibels.

The logarithm of a number usually consists of two parts: a whole number called the *characteristic* and a decimal called the *mantissa*. The characteristic is the integral portion to the left of the decimal point (see examples below), and the mantissa is the value placed to the right. The mantissa is all that appears in the table of logarithms.

In the logarithm, the mantissa is independent of the position of the decimal point, while the characteristic is dependent only on the position of the number with the relation to the decimal point. Thus, in the following examples:

	Number	Logarithm
(a)	4021.	= 3.604
(b)	402.1	= 2.604
(c)	40.21	= 1.604
(d)	4.021	= 0.604
(e)	.4021	= -1.604
(f)	.04021	= -2.604

It will be seen that the characteristic is equal, algebraically, to the number of digits *minus one* to the left of the decimal point.

In (a) the characteristic is 3, in (b) 2, in (d) 0, in (e) -1, in (f) -2. The following should be remembered: (1) that for a number greater than 1, the characteristic is *one less* than the number of digits to the left of the decimal point; (2) that for a number wholly a decimal, the characteristic is *negative* and is numerically *one greater* than the

number of ciphers immediately following the decimal point. Notice (e) and (f) in the above examples.

To find a common logarithm of any number, proceed as directed herewith. Suppose the number to be 5576. First, determine the characteristic. An inspection will show that this number will be three. This figure is placed to the *left* of a decimal point. The mantissa is now found by referring to the logarithm table. Proceed selecting the first two numbers which are 55, then glance down the N column until coming to these figures. Advance to the right until coming in line with the column headed 7; the number will be 746. (Note that the column headed 7 corresponds to the *third* figure in the number 5576). Place the mantissa 746 to the *right* of the decimal point making the number now read 3.746. This is the logarithm of 5576. *Important*: do not consider the last figure, 6, in the number 5576 when looking for the mantissa in the accompanying three-place tables; in fact, disregard all digits beyond the first three when determining the mantissa. However, be doubly sure to include *all* figures when ascertaining the magnitude of the *characteristic*.

Practical applications of logarithms to decibels will follow. Other methods of using logarithms will be discussed as the subject develops.

Power Levels

In the design of radio devices and amplifying equipment, the standard power level of six milliwatts (.006 w) is the arbitrary reference level of zero decibels. All power levels above the reference level are designated as plus quantities, and below as minus. The figure is always prefixed by a plus (+) or minus (-) sign indicating the direction in which the quantity is to be read.

Power to Decibels

The power output (watts) of any amplifier may be converted into decibels by the following formula, assuming that the input and output impedances are equal;

$$N_{db} = 10 \text{ Log}_{10} \frac{P_1}{P_2} \quad (2)$$

where N_{db} is the desired power level in decibels; P_1 , the output of the amplifier,

and P_2 , the reference level of 6 milliwatts. The subnumeral, 10, affixed to the logarithm indicates that the log is to be extracted from a log table using 10 as the base, such as the one given here.

Substitute values for the letters in the above formula as in the following:

An amplifier using 2A5 tube should be able to deliver an undistorted output of three watts. How much is this in decibels?

$$\begin{aligned} \text{Solution by formula (2)} \\ P_1 \quad 3 \\ - = - = 500 \\ P_2 \quad .006 \end{aligned}$$

$10 \times \text{Log } 500 = 10 \times 2.69$
therefore $10 \times 2.69 = 26.9$ DECIBELS.

Substituting other values for those shown allows any output power to be converted into decibels *provided* that the decibel equivalent is *above* the zero reference level or the power is *not less* than 6 milliwatts.

To solve almost all problems to which the solution will be given in minus decibels, an understanding of *algebraic addition is required*. To add algebraically, it is necessary to observe the plus and minus signs of expressions. (Do not confuse these signs with decibels.) In the succeeding illustrations notice that the result is obtained sometimes by addition and at other times by subtraction.

(a)	(b)	(c)	(d)
+2	-4	-4	+4
-4	-2	+2	+2
—	—	—	—
-2	-6	-2	+6

The terms used in (c) are those that apply to decibel calculations.

When the solution to a problem involving logarithms will be in minus decibels

DB	POWER RATIO
0	1.00
1	1.26
2	1.58
3	2.00
4	2.51
5	3.16
6	3.98
7	5.01
8	6.31
9	7.94
10	10.00
20	100
30	1,000
40	10,000
50	100,000
60	1,000,000
70	10,000,000
80	100,000,000

(when the power level under consideration is less than 6 milliwatts), note particularly that the characteristic of this logarithm will be prefixed by a minus sign (—). Note also that this sign affects *only* the characteristic; the mantissa remains positive. The mantissa *always* remains positive, regardless of whether the solution of the problem results in a positive or a negative characteristic.

A prefix —1 to a logarithm means that the first significant figure of the number which it represents will be the *first* place to the *right* of the decimal point; —2 means that it will occupy the second place to the right while the first will be filled by a cipher; —3, the third place with two ciphers filling the first and second, and so on.

To multiply a logarithm with a *minus* characteristic and a positive mantissa by another number, each part must be considered separately, multiplied by the

number (10 or 20 for decibel calculations), and then the products added algebraically. Thus, in the following illustration:

A preamplifier for a microphone is feeding 1.5 milliwatts into the line going to the regular speech amplifier. What is this power level expressed in decibels? Solution by formula (2):

$$\begin{aligned} P_1 &= .0015 \\ \frac{P_1}{P_2} &= \frac{.0015}{.006} = .25 \end{aligned}$$

Log .25 = —1.397 (from table). Therefore, $10 \times -1.397 = (10 \times -1 = -10) + (10 \times .397 = 3.97)$; adding the products *algebraically* gives 6.03 DB.

By substituting other values for those in the above example, any output power *below* 6 milliwatts (zero reference level) can be converted into decibels.

Determining Db Gain or Loss

In using amplifiers, it is a prime requisite to be able to indicate gain or loss in *decibels*. To determine the gain or loss in db employ the following formula:

$$\begin{aligned} \text{(gain) } N_{db} &= 10 \text{ Log } \frac{P_o}{P_i} \quad (3) \\ \text{(loss) } N_{db} &= 10 \text{ Log } \frac{P_i}{P_o} \quad (4) \end{aligned}$$

where N_{db} is the number of db gained or lost; P_i , the input power, and P_o , the output power.

Applying, for example, formula (3): Suppose that an intermediate amplifier is being driven by an input power of 0.2 watt and after amplification, the output is found to be 6 watts.

$$\begin{aligned} \frac{P_o}{P_i} &= \frac{6}{.2} = 30 \\ \text{Log } 30 &= 1.48 \end{aligned}$$

Therefore $10 \times 1.48 = 14.8$ DB POWER GAIN.

Amplifier Ratings

The technical specifications or rating on power amplifiers should contain the following information: the overall gain in decibels, the power output in watts, the value of the input and output impedances, the input signal level in db, the input signal voltage and the power output level in decibels.

If the specifications on an amplifier in-

THREE-PLACE LOGARITHMS

N	0	1	2	3	4	5	6	7	8	9
00	000	000	000	000	000	000	000	000	000	000
10	000	004	008	012	017	021	025	029	033	037
11	041	045	049	053	056	060	064	068	071	075
12	079	082	086	089	093	096	100	103	107	110
13	113	117	120	123	127	130	133	136	139	143
14	146	149	152	155	158	161	164	167	170	173
15	176	179	181	184	187	190	193	195	198	201
16	204	206	209	212	214	217	220	222	225	227
17	230	233	235	238	240	243	245	248	250	252
18	255	257	260	262	264	267	269	271	274	276
19	278	281	283	285	287	290	292	294	296	298
20	301	303	305	307	309	311	313	316	318	320
21	322	324	326	328	330	332	334	336	338	340
22	342	344	346	348	350	352	354	356	358	359
23	361	363	365	367	368	371	372	374	376	378
24	380	382	383	385	387	389	390	392	394	396
25	397	399	401	403	404	406	408	409	411	413
26	415	416	418	420	421	423	424	426	428	429
27	431	433	434	436	437	439	440	442	444	445
28	447	448	450	451	453	454	456	457	459	460
29	462	463	465	466	468	469	471	472	474	475
30	477	478	480	481	482	484	485	487	488	490
31	491	492	494	495	496	498	499	501	502	503
32	505	506	507	509	510	511	513	514	515	517
33	518	519	521	522	523	525	526	527	528	530
34	531	532	534	535	536	537	539	540	541	542
35	544	545	546	547	549	550	551	552	553	555
36	556	557	558	559	561	562	563	564	565	567
37	568	569	570	571	572	574	575	576	577	578
38	579	580	582	583	584	585	586	587	588	589
39	591	592	593	594	595	596	597	598	599	601
40	602	603	604	605	606	607	608	609	610	611
41	612	613	614	616	617	618	619	620	621	622
42	623	624	625	626	627	628	629	630	631	632
43	633	634	635	636	637	638	639	640	641	642
44	643	644	645	646	647	648	649	650	651	652
45	653	654	655	656	657	658	659	659	660	661
46	662	663	664	665	666	667	668	669	670	671
47	672	673	673	674	675	676	677	678	679	680
48	681	682	683	683	684	685	686	687	688	689
49	690	691	692	692	693	694	695	696	697	698
50	699	699	700	701	702	703	704	705	705	706
51	707	708	709	710	711	712	713	713	715	715
52	716	716	717	718	719	720	721	722	722	723
53	724	725	725	726	727	728	729	730	730	731
54	732	733	734	734	735	736	737	738	738	739
N	0	1	2	3	4	5	6	7	8	9

clude only the input and output signal levels in db, it then is necessary to calculate how much these values represent in power. The methods employed to determine power levels are not similar to those used in previous calculations. Caution should, therefore, be taken in reading the following explanations, with particular care and attention being paid to the minor arithmetical operations.

The Antilogarithm

To determine a power level from some given decibel value, it is necessary to invert the logarithmic process formerly employed in converting power to decibels. Here, instead of looking for the log of a number, it is now necessary to find the *antilogarithm* or number corresponding to a given logarithm.

In deriving a number corresponding to a logarithm, it is important that these simple rules be committed to memory: (1) that the figures that form the original number from a corresponding logarithm depend entirely upon the mantissa or decimal part of the log (2) that the characteristic serves only to indicate where to place the decimal point of the original number, (3) that, if the original number was a whole number, the decimal point would be placed to the extreme right.

The procedure of finding the number corresponding to a logarithm is explained by the following: Suppose the logarithm to be 3.574. First, search in the table under any column from 0 to 9 for the numbers of the mantissa 574. If the exact number cannot be found, look for the next *lowest* figure which is nearest to, but less than, the given mantissa. After the mantissa has been located, simply glance immediately to the left to the N column and there will be read the number, 37. This number comprises the first two figures of the number corresponding to the antilog. The third figure of the number will appear at the head of the column in which the mantissa was found. In this instance the number heading the column will be 5. If the figures have been arranged as they have been found, the number will now be 375.

Now, since the characteristic is 3, there must be four figures to the left of the decimal point; therefore by annexing a cipher, the number becomes 3750; this is the number that corresponds to

the logarithm 3.574. If the characteristic were 2 instead of 3, the number would be 375. If the logarithm were -3.574 or -1.574, the antilogs or corresponding numbers would be .00375 and .375 respectively. After a little experience, a person can obtain the number corresponding to a logarithm in a very few seconds.

Converting Decibels to Power

It is always convenient to be able to convert a decibel value to a power equivalent. The formula used for converting decibels into watts is similar in many respects to equation (2), the only difference being that the factor P₁ corresponding to the power level is not known. Usually the formula for converting decibels into power is written as:

$$N_{db} = 10 \text{ Log } \frac{P_1}{.006} \quad (5)$$

It is difficult to derive the solution to

THREE-PLACE LOGARITHMS										
N	0	1	2	3	4	5	6	7	8	9
55	740	741	741	742	743	744	745	746	747	747
56	748	749	749	750	751	752	752	753	754	755
57	755	756	757	758	758	759	760	761	761	762
58	763	764	764	765	766	767	767	768	769	770
59	770	771	772	773	773	774	775	776	776	777
60	778	778	779	780	781	781	782	783	783	784
61	785	786	786	787	788	788	789	790	791	791
62	792	793	793	794	795	795	796	797	798	798
63	799	800	800	801	802	802	803	804	804	805
64	806	806	807	808	809	810	810	811	811	812
65	813	813	814	814	815	816	816	817	818	818
66	819	820	820	821	822	822	823	824	824	825
67	826	826	827	828	828	829	829	830	831	831
68	832	833	833	834	835	835	836	837	837	838
69	838	839	840	840	841	842	842	843	843	844
70	845	845	846	847	848	848	849	849	850	850
71	851	851	852	853	853	854	854	855	856	856
72	857	857	858	859	859	860	860	861	861	862
73	863	863	864	865	865	866	866	867	868	868
74	869	869	870	871	871	872	872	873	873	874
75	875	875	876	876	877	877	878	879	879	880
76	880	881	882	882	883	883	884	884	885	885
77	886	887	887	888	888	889	889	890	891	891
78	892	892	893	893	894	894	895	896	896	897
79	897	898	898	899	899	900	900	901	902	902
80	903	903	904	904	905	905	906	906	907	907
81	908	909	909	910	910	911	911	912	912	913
82	913	914	914	915	915	916	917	917	918	918
83	919	919	920	920	921	921	922	922	923	923
84	924	924	925	925	926	926	927	927	928	928
85	929	929	930	930	931	932	932	933	933	934
86	934	935	935	936	936	937	937	938	938	939
87	939	940	940	941	941	942	942	943	943	944
88	944	945	945	946	946	947	947	948	948	948
89	949	949	950	950	951	951	952	952	953	953
90	954	954	955	955	956	956	957	957	958	958
91	959	959	960	960	960	961	961	962	962	963
92	963	964	964	965	965	966	966	967	967	968
93	968	968	969	969	970	970	971	971	972	972
94	973	973	974	974	975	975	976	976	977	977
95	977	978	978	979	979	980	980	980	981	981
96	982	982	983	983	984	984	985	985	985	986
97	986	987	987	988	988	989	989	989	990	990
98	991	991	992	992	993	993	993	994	994	995
99	995	996	996	996	997	997	998	998	999	999
00	000	004	008	012	017	021	025	029	033	037
N	0	1	2	3	4	5	6	7	8	9

the above equation because of the expression being written in the reverse. However, by rearranging the various factors, the expression can be simplified to permit easy visualization; thus:

$$P = .006 \times \text{antilog} \frac{N_{ab}}{10} \quad (6)$$

where P is the desired power level; .006, the reference level in milliwatts; N_{ab} , the decibels to be converted, and 10, the divisor.

To determine the power level, P, from a decibel equivalent, simply divide the decibel value by 10, then take the number comprising the antilog and multiply it by .006; the product gives the power level of the decibel value.

NOTE: In all problems dealing with the conversion of *minus* decibels to power, it often happens that the decibel value $-N_{ab}$, is not always equally divisible by 10. When this is the case, the numerator in the factor $-N_{ab}/10$ must be made evenly divisible by the denominator in order to derive the proper power ratio. Note that the value $-N_{ab}$ is negative; hence, when dividing by 10, the negative signs must be observed and the quotient labeled accordingly.

To make the numerator in the value $-N_{ab}$ equally divisible by 10, proceed as follows: Assume $-N_{ab}$ to be the value -38; hence, to make this figure equally divisible by 10, we must add a -2 to it, and, since we have added a negative 2 to it, we must also add a positive 2 to make the net result the same.

Our decibel value now stands, $-40 + 2$. Dividing both of these figures by 10 (as in equation 6), we have -4 and a plus 0.2. Putting the two of them together, we have -4.2 as our resulting logarithm, with the negative characteristic and positive mantissa required to indicate a number smaller than one.

While the above discussion applies strictly to negative values, the following examples will clearly show the technique to be followed for almost all practical problems.

(a) The output level of a popular velocity ribbon microphone is rated at -74 db. What is the equivalent in milliwatts?

Solution by equation (6)

$$\frac{-N_{ab}}{10} = \frac{-74}{10} \quad (\text{not equally divisible by } 10)$$

Routine:

$$\begin{array}{r} -74 \\ -6 \quad \quad \quad +6 \\ \hline -80 \quad \quad \quad +6 \\ -N_{ab} \quad -80 +6 \\ \hline 10 \quad \quad \quad 10 = -8.6 \end{array}$$

Antilog -8.6 = .00000004
 .006 x .00000004 = .0000000024 watt or 240 microwatts

(b) This example differs somewhat from that of the foregoing one in that the mantissas are added differently. A low-powered amplifier has an input signal level of -17.3 db. How many milliwatts does this value represent?

Solution by equation (6)

Routine:

$$\begin{array}{r} -17.3 \\ -2.7 \quad \quad \quad +2.7 \\ \hline -20.0 \quad \quad \quad +2.7 \\ -N_{ab} \quad -20 +2.7 \\ \hline 10 \quad \quad \quad 10 = -2.27 \end{array}$$

Antilog -2.27 = .0186
 .006 x .0186 = .0001116 watt or .1116 milliwatts.

Voltage Amplifiers

When plans are being drafted contemplating the design of power amplifiers, it is essential that the following data be determined: first, the input and output signal levels to be used; second, the size of the power tubes that will adequately deliver sufficient undistorted output; third, the input signal voltage that must be applied to the amplifier to deliver the desired output. This last requirement is the most important in the design of voltage amplifiers.

The voltage step-up in a transformer-coupled amplifier depends chiefly upon the μ of the tubes and the turns ratio of the interstage coupling transformers. The step-up value in any amplifier is calculated by multiplying the step-up fac-

KEN-O-GRAF
WATTS-VS-DECIBELS

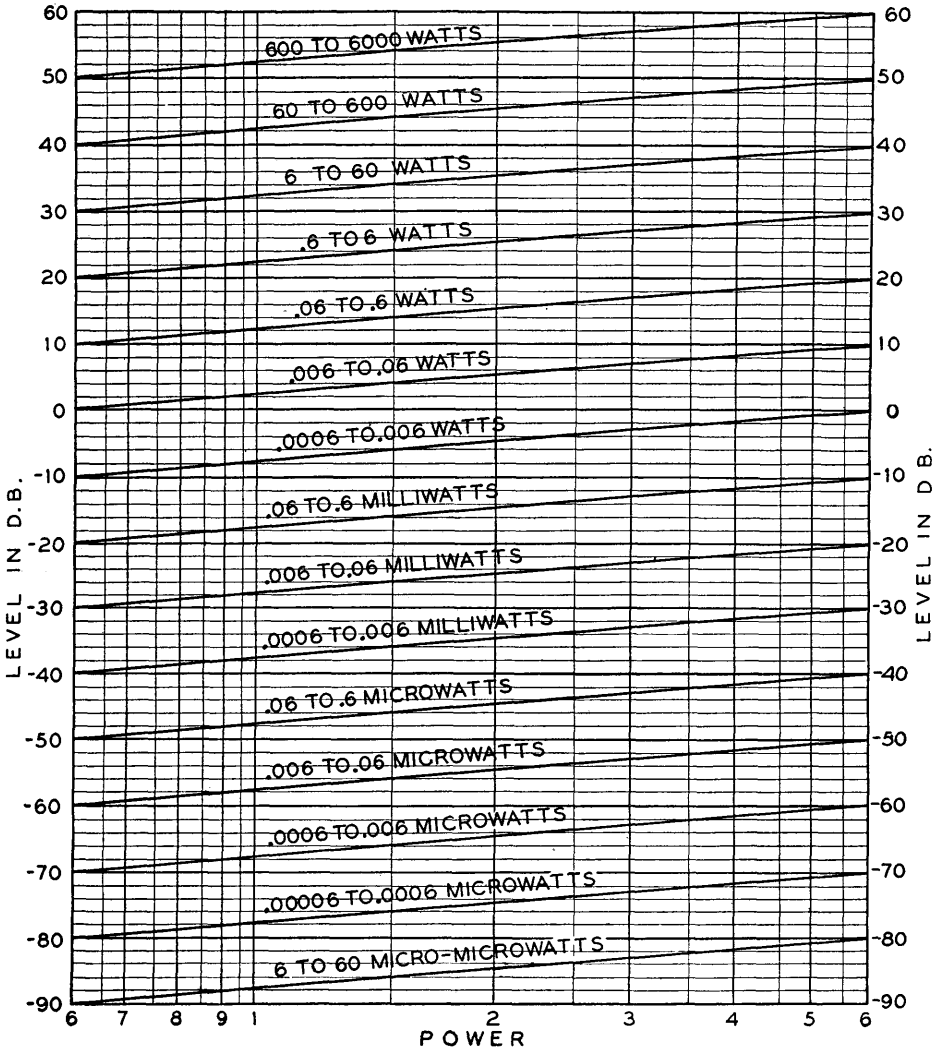

Based on .006 watts at zero level.

Chart Courtesy Kenyon Transformer Co.

Power levels between 6 micromicrowatts and 6000 watts may be referred to corresponding decibel levels between -90 and 60 db, and vice versa, by means of the above chart. Fifteen ranges are provided. Each curve begins at the same point where the preceding one ends, enabling uninterrupted coverage of the wide db and power ranges with condensed chart. For example: the lowermost curve ends at -80 db or 60 micromicrowatts and the next range starts at the same level. Zero db is taken as 6 milliwatts (.006 watt).

tor of each voltage amplifying or step-up device. Thus, for example, if an amplifier were designed having an output transformer with a ratio of 3:1 coupled to a tube having a μ of 7, the voltage step-up would be approximately 3 times 7 or 21. It is seldom that the total product will be exactly the figure derived because it is not quite possible to realize amplification equal to the full μ of the tube.

From the voltage gain in an amplifier, it is possible to calculate the input and output signal levels and at the same time be able to determine at what level the input signal must be in order to obtain the desired output. By converting voltage ratios into decibels, power levels can be determined. Hence, to find the gain in db when the input and output voltages are known, the following expression is used:

$$(\text{gain}) N_{ab} = 20 \text{ Log } \frac{E_1}{E_2} \quad (7)$$

where E_1 , is the output voltage, and E_2 , the input voltage.

Employing the above equation in a practical problem, note the logarithm is multiplied by 20 instead of by 10 as in previous examples. For instance:

A certain one-stage amplifier consists of the following parts: 1 input transformer, ratio 2:1, and 1 output tube having a μ of 95. Determine the gain in decibels with an input voltage of 1 volt.

Solution by equation (7)

$$2 \times 95 = 190 \text{ voltage gain}$$

$$\text{therefore, } \frac{E_1}{E_2} = \frac{190}{1} = 190$$

$$\text{Log } 190 = 2.278$$

$20 \times 2.278 = 45.56$ DECIBELS GAIN.

To reverse the above and convert decibels to voltage ratios, use the following expression:

$$E (\text{gain}) = \text{antilog } \frac{N_{ab}}{20} \quad (8)$$

where E is the voltage gain (power ratio); N_{ab} , the decibels, and 20, the divisor.

To find the gain, simply divide the decibels by 20, then extract the antilog from the quotient; the result gives the voltage ratio.

Input Voltages

In designing power amplifiers, it is paramount to have *exact* knowledge of the magnitude of the input signal voltage necessary to drive the output power tubes to maximum undistorted output.

To determine the input voltage, take the *peak voltage* necessary to drive the grid of the last class-A amplifier tube to maximum output and divide this figure by the total overall gain *preceding this stage*.

Computing Specifications

From the preceding explanations the following data can be computed with a very high degree of accuracy:

- (1) Voltage amplification
- (2) Overall gain in db
- (3) Output signal level in db
- (4) Input signal level in db
- (5) Input signal level in watts
- (6) Input signal voltage

Microphone Levels

Practically all acoustic-electric apparatus used to energize amplifiers have output levels rated in decibels. The output signal levels of these devices vary considerably, as may be noted from the table below:

	Average
	Decibels
Phonographic pickup.	0 to -30 -15
Carbon microphones.	-30 to -60 -45
Piezo-electric micro-	
phones	-55 to -80 -60
Dynamic microphones	-75 to -95 -85
Condenser micro-	
phones	-80 to -100 -90
Velocity microphones	-70 to -110 -85

In general, the lower the output signal level, the higher will be the acoustic fidelity over the entire audio spectrum.

The output levels of microphones and phonograph pickups have the same power values ascribed to them as those derived from calculating power output levels of amplifiers. Therefore, the same equations employed in connection with power ratios are similarly applied when converting output signal levels to power levels.

Push-Pull Amplifiers

To double the output of any cascade amplifier, it is only necessary to connect

in push-pull the last amplifying stage and replace the interstage and output transformers with push-pull types.

To determine the voltage gain (voltage ratio) of a push-pull amplifier, take the ratio of one *half* of the secondary winding of the push-pull transformer and multiply it by the μ of one of the output tubes in the push-pull stage; the product, *when doubled*, will be the voltage amplification or step-up.

Acoustically, that is from the loud-speaker standpoint, it takes approximately three db before any change in the volume of sound is noted. This is because the intensity of sound as heard by the ear varies logarithmically with the acoustic power. For practical purposes it is only necessary to remember that if two sounds differ in physical intensity by less than three db, they sound practically alike.

Preamplifiers are employed to raise low input signal levels up to some re-

quired input level of another intermediate or succeeding amplifier. For example: if an amplifier was designed to operate at an input level of -30 db and instead a considerably lower input level were used, a preamplifier would then have to be designed to bring the low input signal up to the rated input-signal level of -30 db to obtain the full undistorted output from the power tubes in the main amplifier. The amount of gain necessary to raise a low input-signal level up to another level may be determined by the following equation:

$$E \text{ (gain)} = \text{antilog} \frac{N_{db1} - N_{db2}}{20} \quad (9)$$

where E is the voltage step-up or gain; N_{db1} , the input signal level of the preamplifier or the new input signal level; N_{db2} , the input signal level to the intermediate amplifier, and 20, the divisor.



CHAPTER 4

Antennas

Antenna and Feeder Types—Radiator and Feeder Dimensions —Coupling—Directive Arrays—Field Patterns

RADIO waves are electromagnetic waves which consist of condensations and rarefactions of energy as they travel through space.

Electromagnetic waves travel through space with the speed of light (186,000 miles or 300,000,000 meters per second). Radio waves include an electrostatic and an electromagnetic component. The electrostatic component corresponds to the voltage of the wave, and the electromagnetic component corresponds to the wave current.

High-frequency waves travel in direct rays from transmitter to receiver, but also can be radiated upward into the variable ionosphere to be bent downward in an indirect ray.

Energy radiated from the transmitting antenna along the surface of the earth is rapidly attenuated so that it is practically useless for consistent communication for distances over 100 miles.

This ray was formerly thought to be guided by the earth in the same manner that a wave is guided by a pair of wires. Investigation by the Bell Telephone Laboratories has proved this assumption to be incorrect.

Energy sent off at an angle above the horizon is partly returned to earth by the bending effect of the ionized particles in the various layers of the ionosphere.

The *ionosphere* consists of layers of ionized particles of gas located above the stratosphere and extending up to possibly 750 miles above the surface of the earth (H layer).

The amount of bending which the sky wave undergoes depends on the frequency of the wave and the amount of ionization in the ionosphere which is, in

turn, dependent on ultra-violet radiation from the sun. The ionization is much greater in the daytime. Also, the height of the ionosphere is affected by the sun. Therefore, radio waves act very differently at night.

The higher the frequency of the radio wave, the more it penetrates the ionosphere and the less it is bent back toward earth. The 160- and 80-meter signals are bent so much by the layers of the ionosphere that they are often bent back; thus if these low-frequency short waves are radiated straight up, they will return back to earth (close to the transmitter). As the frequency goes up beyond about 5,000 kc., it is found that waves whose angle with the horizon exceeds a certain critical angle never return to earth. Thus, as the frequency goes up, it is usually desirable to confine radiation to low angles since the high-angle waves simply penetrate the ionosphere and are lost.

Signals above about 45,000 kc. are bent so slightly that they seldom return to earth, although under exceptional circumstances radio waves of 75,000 kc. have been known to return to earth for very short periods of time.

Thus, the sky wave does not give consistent communication at frequencies above 45,000 kc., and even above about 22,000 kc. the results are not good enough for commercial use.

The ground wave of a 14,000-kc. transmitter rarely can be heard over a hundred miles away. Also, the first bending of the sky wave rarely brings the sky wave back down to earth within three hundred miles from the 14,000-kc. transmitting antenna at night. Thus, there is

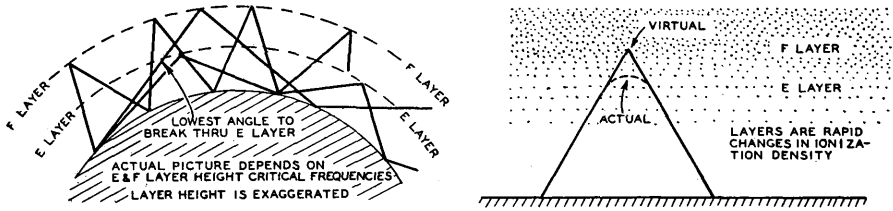

Figure 1. Showing some of the many possible paths of a high-frequency "sky wave" signal.

an area between 100 and 300 miles from the transmitter in which the signals cannot usually be heard. This area lies in what is termed the *skip distance*. Moving closer to or farther away from the transmitter allows the signals to be heard, but in the skip distance (or zone) no reception is possible.

The lower the angle of radiation of the wave, with respect to the horizon, the farther away will the wave return to earth and the greater the skip distance. The wave can be reflected back up into the ionosphere by the earth and then be reflected back down again, causing a second skip distance area. The drawing of figure 1 shows the multiple reflections possible. When the receiver receives signals which have traveled over more than one path between transmitter and receiver, the signal impulses will not all arrive at the same instant as they do not all travel the same distance. When two or more signals arrive in the same phase at the receiving antenna, the resulting signal in the receiver will be quite loud. On the other hand, if the signals arrive 180 degrees out of phase so they tend to neutralize each other, the received signal will drop—perhaps to zero if perfect neutralization occurs. This explains why high-frequency signals fade in and out.

Fading can be greatly reduced on the high frequencies by using a transmitting antenna with sharp vertical directivity, thus cutting down the number of multiple paths of signal arrival. A receiving antenna with similar characteristics (sharp vertical directivity) will further reduce fading. It is desirable when using antennas with sharp vertical directivity to use the lowest vertical angle consistent with good signal strength for the frequency used. This cuts down the number of hops the signal has to make to reach the receiver, and consequently reduces

the chance for arrival via different paths.

Selective Fading

Selective fading affects all modulated signals. Modulated signals are not a single frequency signal but consist of a narrow band of waves perhaps fifteen kc. wide. It will be seen that the whole modulated signal band may not be neutralized at any instant, but only part of it. This causes a peculiar and changing form of audio distortion at the receiver, which suppresses some audio frequencies, emphasizes others, is known as *selective fading*.

Radiation Angle

The reflection of low-frequency waves and the reflection of high-frequency waves from the ionosphere show that for any given distance and ionosphere height there is an ideal angle with the horizon which the radio wave should take. For long-distance communication the angle of radiation should be low, while for short-distance communication the angle of radiation should be higher. Different types of antennas have different major angles of radiation as will be shown later.

Antenna Radiation

When an alternating current is passed through a conductor, an alternating electro-magnetic field extends around that conductor. Energy is alternately stored in the field and then returned to the conductor. As the frequency is raised, it is found that more and more of the energy does not return to the conductor but is radiated off into space in the form of electromagnetic waves which travel through space with the speed of light. Radiation from a wire or line is materially increased wherever there is a

sudden change in the electrical constants of the line. Such changes produce reflection, which places standing waves on the line.

For example, a wire in space, to which is fed radio-frequency energy with a wavelength close to 2.08 times the length of the wire in meters, is said to *resonate* as a *dipole* or half-wave antenna at that wavelength or frequency. As both ends of the dipole are terminated in an infinite impedance (open circuit), there is a mismatch at each end, which produces reflection. This means that an incident radio-frequency wave will travel to one end of the dipole and will be reflected right back toward the center of the dipole.

The returning waves which have been reflected meet the next incident wave, and the voltage and current at any point along the antenna are the algebraic sum of the two waves. At the ends of the dipole the voltages add up while the currents in the two waves cancel, thus producing *high voltage and low current at the ends* of the dipole or half-wave section of wire. In the same manner, it is found that the currents add up while the voltages cancel at the center of the dipole. *Thus, at the center there is high current but low voltage.* Note in figure 2 that the current in the dipole uniformly decreases as the measuring instrument is moved out from the center to either end, while the voltage uniformly increases (the polarities being opposite at the two ends, however). The curve of voltage or current represents a standing wave on the wire. If the voltage, or current, measured the same all along the wire, it would indicate the absence of standing waves.

The points of maximum and minimum current and voltage are described as *loops* and *nodes*. A voltage or current loop in a wire or line is a point of maximum voltage or current. A voltage or current node is a point of minimum or zero voltage or current. In a wire or line containing standing waves but no reactance, it will always be found that a voltage node coincides with a current loop, and a current node coincides with a voltage loop.

A nonradiating transmission line must be always terminated in its characteristic impedance in order to avoid reflection and standing waves. A Hertz antenna is an ideal example of a type of trans-

mission line that is *not* terminated in its characteristic impedance at its ends.

A two-wire resonant line, such as zepp feeders, may have high reflection losses and standing waves, but the effective radiation can be reduced by having the radiation from two adjacent wires in such amplitude and phase as to cancel out. In other words, the radiation from one wire is absorbed by the other wire, and vice-versa.

Frequency, Wavelength, Antenna Length

All antennas used by amateurs are based on the fundamental Hertz type, which is any wire in space a half wavelength long electrically. The Marconi antenna is a special type of Hertz antenna used only when space considerations necessitate using something shorter than half of an electrical wavelength. The Marconi antenna always is grounded and is an odd number of quarter wavelengths long electrically. In other words, the ground acts as the missing quarter wavelength.

In any discussion of antennas, the relationship between wavelength and frequency must be kept in mind. As the velocity of radio waves through space is constant at the speed of light, it will be seen that the more waves that pass a point per second (higher the frequency), the closer together the peaks of those waves must be (shorter the wavelength). Therefore, the higher the frequency the lower the wavelength. Frequency describes the number of wave peaks (in cycles or thousands of cycles) passing a point per second. Wavelength describes the distance in meters between adjacent peaks of a wave train.

A radio wave in space can be compared to a wave in water. The wave, in either case, has peaks and troughs; one peak and one trough constitute a *full wave* or *one wavelength*.

As a radio wave travels 300,000,000 meters a second (speed of light), a frequency of one cycle per second corresponds to a wavelength of 300,000,000 meters. As the frequency increases, the wavelength decreases; so if the frequency is multiplied by a million, the wavelength must be divided by a million in order to have them still refer to the same thing.

Thus, a frequency of one million cycles

per second (a thousand kilocycles) equals a wavelength of 300 meters. Multiplying frequency by ten and dividing wavelength by ten we get: a frequency of 10,000 kilocycles equals a wavelength of 30 meters. Multiplying by ten and dividing by ten again we get: a frequency of 100,000 kilocycles equals 3-meters wavelength. Therefore, remember when changing wavelength to frequency that *frequency in kilocycles equals 300,000 divided by wavelength in meters*. Also, wavelength in meters equals 300,000 divided by frequency in kilocycles.

$$F_{kc} = \frac{300,000}{\lambda}$$

$$\lambda = \frac{300,000}{F_{kc}}$$

When speaking of antenna lengths, it is necessary to speak of *electrical length*. When speaking of a half-wave antenna, we mean one whose electrical length is a half wave. Actually a half-wave antenna is slightly *less* than a half wave long *physically*, due to the end effects and the fact that the velocity of a high-frequency radio wave traveling along a conductor is not as high as it is in free space.

Below 30,000 kilocycles this effect is relatively constant, so that an electrical half wave is a fixed percentage shorter than a physical half wavelength. This percentage is approximately 5%; therefore most half-wave antennas are really 95% of a half wave long. This is taken into consideration in the formula shown below. Thus, a half-wave antenna resonant at exactly 80 meters would be 80 x 1.56, or 124.8 feet long physically.

Another way of saying the same thing is that a wire resonates at a wavelength of about 2.1 times its length in meters.

$$\begin{array}{l} \text{Wire length} \\ \text{of half-wave} \\ \text{radiator, in feet} \end{array} = 1.56\lambda = \frac{467,400}{F_{kc}} = \frac{467.4}{F_{Mc}}$$

Harmonic Resonance

A wire in space resonates at more than one frequency. The *lowest* frequency at which it resonates is called its *fundamental* frequency, and at that frequency it is approximately a half wavelength long. A wire can have two, three, four, five or more standing waves on it, and thus resonates at approximately the

integral harmonics of its fundamental frequency. However, the higher harmonics are not exactly integral multiples of the lowest resonant frequency as end effects affect only the outer quarter waves.

As the end effect comes in *only* at the ends, regardless of whether the antenna has its minimum resonant length or any of the longer resonant lengths (harmonic resonance), the equivalent electrical length approaches the actual physical length more and more, as the antenna length, measured in wavelengths, increases.

The following two formulas can be used to determine either the frequency or length of a wire with a given number of half waves on it. These formulas are accurate between 3000 and 30,000 kc.

$$L = \frac{492 (K-.05)}{F_{Mc}} \quad F_{Mc} = \frac{492 (K-.05)}{L}$$

Where F equals frequency in *megacycles*. L equals length in feet. K equals number of half waves on wire.

Radiation Resistance, Antenna Impedance

A half-wave antenna is much like a tuned tank circuit. The main difference lies in the fact that the elements of inductance, capacity and resistance are *lumped* in the tank circuit and are *distributed* throughout the length of an antenna. The center of a half-wave radiator is effectively at ground potential as far as r.f. voltage is concerned, although the current is highest at that point. See figure 2.

When the antenna is resonant, and it always should be for best results, the

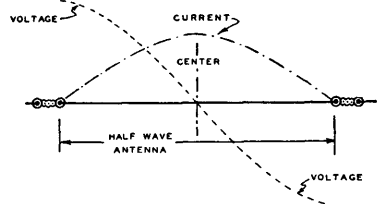

SHOWING HOW STANDING WAVES EXIST ON A RESONANT ANTENNA CURRENT IS MAXIMUM AT CENTER — VOLTAGE IS MAXIMUM AT ENDS

FIGURE 2

impedance at the center is a pure resistance and is termed the radiation resistance. Radiation resistance is a fictitious term used to express the power radiated by the antenna. It is the resistance which would dissipate the same amount of power that is being radiated by the antenna.

The radiation resistance at the voltage node (current loop: in other words, minimum voltage and maximum current) depends on the length of the antenna and its proximity to nearby objects which either absorb or reradiate power, such as the ground, other wires, etc.

The theoretical radiation resistance of a grounded quarter-wave antenna equals 36.57 ohms. A half-wave antenna, far from ground and other reflecting objects, has a radiation resistance at the center exactly twice as high, namely 73.14 ohms, since each half of the half-wave antenna carries the same current and radiates the same amount of energy for a given impressed voltage as does the grounded quarter-wave antenna.

Because the power throughout the antenna is the same, the impedance of the antenna at any point along its length merely expresses the ratio between voltage and current at that point. Thus, the lowest impedance occurs where the current is highest, namely: at the center. The impedance rises uniformly toward each end. The impedance at the center of a resonant half-wave antenna is about 73 ohms and at the ends, approximately 2400 ohms, *provided* the antenna is remote from ground.

If a vertical half-wave antenna is set up so that its lower end is at the ground level, the effect of the ground reflection

is to increase the radiation resistance to approximately 100 ohms. When a horizontal half-wave antenna is used, the radiation resistance (and, of course, the amount of energy radiated for a given antenna current) depends on the height of the antenna above ground, since the height determines the phase angle between the wave radiated directly in any direction and the wave which combines with it after reflection from the ground.

The radiation resistance of an antenna generally increases with length, although this increase varies up and down about a constantly increasing average. The peaks and dips are caused by the reactance of the antenna when its length does not allow it to resonate at the operating frequency.

Antennas have a certain loss resistance as well as a radiation resistance. The loss resistance defines the power lost in the antenna due to ohmic resistance of the wire, ground resistance, corona discharge and insulator losses. The losses rarely amount to 5% of the power supplied to the antenna at the high frequencies.

Resonating Antennas

Antennas should always be resonated at the frequency of operation (except for certain special types of aperiodic directive arrays, such as the diamond). The radiation efficiency of a resonant wire is many times that of a wire which is not resonant. Thus, an ungrounded antenna should always be an even multiple of a quarter wave long, while a grounded antenna (Marconi) should always be an odd multiple of a quarter wave long. Note that length means *electrical* length in this case. Short wires can be lengthened electrically by series inductive loading. Long wires can be shortened by about one-eighth wavelength by means of a series condenser located near the voltage node.

It is desirable to know the radiation resistance of an antenna when attempting to match a nonresonant transmission line to a resonant antenna. As the antenna end of the line must be terminated in its characteristic surge impedance in order to allow the line to operate without line radiation, it must be attached to the antenna at a point where the antenna impedance equals the line impedance.

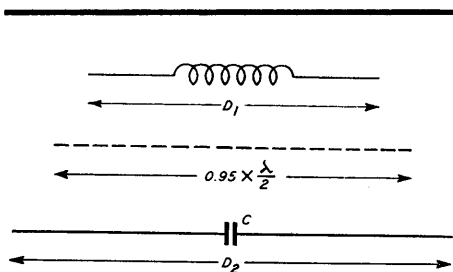

Figure 3. Three antennas, all equal electrically to one-half wavelength.

CHARACTERISTICS AND CONSIDERATIONS

Fundamental Types

Antennas used by amateurs for general coverage are usually of either the *Hertz* or the *Marconi* type. The Hertz antenna consists of a wire suspended above the earth and insulated from it; it is of such a length as to be some multiple of a half wave.

Usually a Marconi antenna is one quarter or three quarters of a wave in length and is connected to the earth or to a ground screen for the purpose of obtaining resonance. The ground acts as a mirror in effect and takes the place of the extra quarter wave that would be required to resonate the wire were it not grounded.

Most popular for all-around use is the simple half-wave dipole (Hertz) radiator mounted either horizontally or vertically. It can be fed in a number of ways. Hertz antennas usually are most efficient. There is a power loss due to the resistance of the earth connection required with a Marconi radiator.

Grounded (Marconi) antennas are normally used for longer wavelengths where the physical length of a half-wave antenna wire makes such an antenna impractical. The Marconi antenna also is advantageous on mobile vehicles, as its overall span is one half the span required by a half-wave radiator. However, the grounded Marconi antenna is always materially less efficient than the half-wave type; so, wherever possible, the half-wave type should be used.

Radiation Resistance

Along a half-wave antenna the *impedance* varies from a minimum at the center to a maximum at the ends. The impedance is that property which determines the antenna current at any point along the wire for the value of radio-frequency voltage at that point. The main component of this impedance is the radiation resistance; normally, the latter is referred to the center of the half-wave antenna where the current is at maximum. The square of the current multiplied by the radiation resistance is equal to the power radiated by the an-

tenna. For convenience, these values are usually referred to the center of a half-wave section of antenna.

In figure 4 the curves indicate the theoretical center-point radiation resistance of a half-wave antenna for various heights above perfect ground. These values are of some importance in matching untuned radio-frequency feeders to the antenna in order to obtain a good impedance match and an absence of standing waves on the feeders.

Above *average* ground, the actual radiation resistance of a dipole will seldom be that given in the chart of figure 4 which assumes a hypothetical perfect ground having no loss and perfect reflection. Fortunately, the curves for the radiation resistance over most types of earth will correspond rather closely with those of the chart, except that the radiation resistance for a horizontal dipole does not fall off as rapidly as is indicated for heights below an eighth wavelength. However, with the antenna so close to the ground and the soil in a strong field, much of the radiation resistance is actually represented

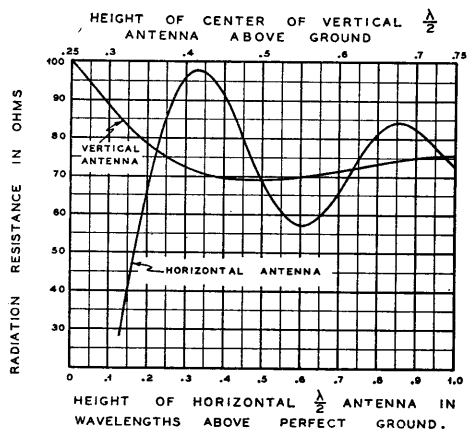

Figure 4. Effect of height on the radiation resistance of a dipole suspended above perfect ground.

by ground loss; this means that a good portion of the antenna power is being dissipated in the earth, which, unlike the hypothetical perfect ground, has resistance. The type of soil also has an effect upon the radiation pattern, especially in the vertical plane, as will be seen later.

If the radiation resistance of an antenna or array is very low, the current at a voltage node will be quite high for a given power. Likewise, the voltage at a current node will be very high. Even with a heavy conductor and excellent insulation, the losses due to the high voltage and current will be appreciable if the radiation resistance is sufficiently low.

Usually, it is not considered desirable

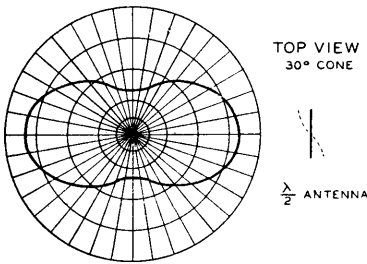

Figure 5. Radiation from half-wave antenna a half wave above perfect ground, for fixed vertical angle of 30°.

to use an antenna or array with a radiation resistance of less than approximately 10 ohms unless there is sufficient directivity, compactness or other advantage to offset the losses resulting from the low radiation resistance.

Ground Resistance

The radiation resistance of a Marconi antenna, especially, should be kept as high as possible. This will reduce the antenna current for a given power, thus minimizing loss resulting from the series resistance offered by the earth connection. The radiation resistance can be kept high by making the Marconi radiator as long as possible (five-sixteenths wave being about the maximum for a series-tuned quarter-wave Marconi) and removed from ground as much as possible (vertical being ideal). Methods of minimizing the resistance of the earth

connection will be found in the discussion of the Marconi antenna.

Directivity of Antennas

When choosing and orienting an antenna system, the radiation patterns of the various common types of antennas should be given careful consideration. The directional characteristics are of still greater importance when a directive antenna array is used.

There are two kinds of antenna directivity: vertical and horizontal. The latter is not generally desirable for amateur work except (1) for point-to-point work between stations regularly communicating with each other, (2) where several broad arrays are so placed as to cover most useful directions from a given location, and (3) when the beam may be directed by electrical or mechanical rotation.

Considerable horizontal directivity can be used, provided that the beam is not narrower than perhaps 5°. Signals follow the great circle path or are within a few degrees of that path a good share of the time.

For general amateur work, however, too much horizontal directivity is ordinarily undesirable, inasmuch as it necessitates having the beam pointed exactly at the station being worked. Making the array rotatable overcomes this obstacle, but arrays having extremely high horizontal directivity are too cumbersome to be rotated, except perhaps above 56 Mc.

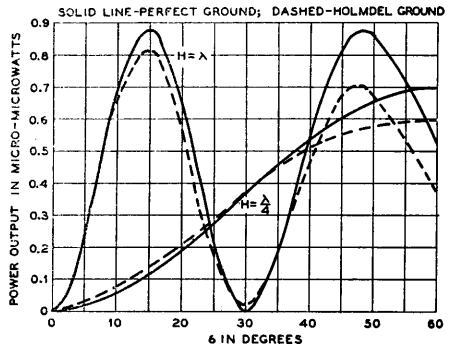

Figure 6. Patterns of vertical directivity for horizontal doublets at height H above perfect and Holmdel, N. J., ground.

On the 28- and 14-Mc. bands and, to an extent on the 7-Mc. band, the matter of vertical directivity is of as much importance as is horizontal directivity. Only the power leaving the antenna near a certain vertical angle is instrumental in putting a signal into a distant receiving antenna; the rest may be considered as largely wasted. In other words the important thing is the amount of power radiated in a desired direction at the useful vertical angles, rather than the actual shape of the directivity curves as read on the ground by a field strength meter.

A nondirectional antenna such as a vertical or horizontal dipole will give excellent results with general coverage on 28 and 14 Mc. if the vertical angle of radiation is favorable. The latter type is slightly directional broadside, especially on 28 Mc., but is still considered as a nondirectional type.

Effect of Average Ground

Most articles appearing in amateur journals discussing antenna radiation have been based upon the perfect ground assumption in order to cover the subject in the most simple manner. Yet, little has been said about the real situation which exists, the ground generally being everything but a perfect conductor. Consideration of the effect of a ground that is not perfect may explain many things.

When the earth is less than a perfect conductor, it becomes a conducting

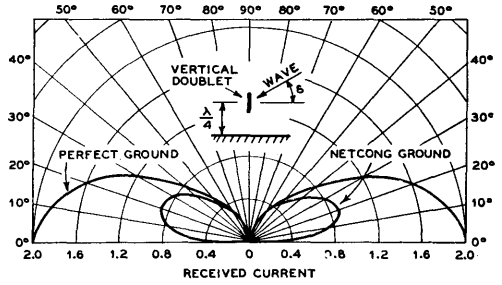

Figure 8. Vertical directivity of vertical doublets above perfect ground and above ground at Netcong, N. J.

dielectric or, perhaps in an extreme case, a leaky insulator.

Let us first study the horizontal antenna above average ground, because it is less seriously affected.

The resulting change in the pattern of an antenna is shown in figure 6, which includes a perfect ground comparison. The ground constants in this case are those for Holmdel, New Jersey. The country there is flat farmland, and probably is similar to midwestern farmland. It will be noted that there is only a moderate loss in power due to the imperfect ground. Figure 7 shows relative power for antennas at various heights over a perfect conductor. These curves are illustrative of the need for height, in order to favor the useful low angles when using a horizontal antenna.

The effect of the earth on the radiation pattern of a vertical dipole is apparent from figure 8. It shows how radiation from a half-wavelength vertical wire is severely reduced by deficiencies of the ground. Even over the most perfect ground available, sea water or salt marsh, radiation at the lowest angles approaches that for a horizontal antenna, and complete cancellation takes place at the horizontal.

Vertical vs. Horizontal

A very important factor in the advantages of horizontal or vertical antennas, therefore, appears to be the condition of the ground. Figure 9 shows a comparison between such doublets elevated 0.6 wavelength above Rumson, New Jersey, salt marsh and Holmdel

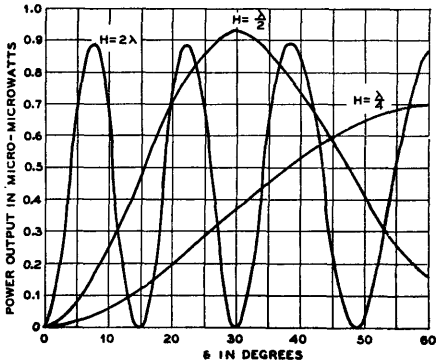

Figure 7. Patterns of vertical directivity for horizontal doublets calculated for perfectly conducting ground.

farmland. This suggests that the horizontal has some advantages for high-angle waves, but none for low angles over dry farmland. On the other hand, there is a substantial advantage favoring the vertical located over wet or marshland when low angles are involved.

The best angle of radiation varies with frequency, layer height and many other factors. For instance, a lower optimum vertical angle is found to hold for high-frequency communication with South America from the U.S.A. than for Europe and the U.S.A.

FEEDING THE ANTENNA

A high-frequency doublet or directional array is usually mounted as high and in the clear as possible for obvious reasons. Power can then be fed to the antenna system via one of the various transmission lines discussed in the next chapter.

However, it is sometimes justifiable to bring part of the radiating system right in to the transmitter, feeding the antenna without benefit of a transmission line. This is permissible when (1) there is insufficient room to erect a 75- or 160-meter Hertz and feed line, (2) when a long wire is operated on one of the higher frequency bands on a harmonic. In either case, it is usually possible to

get the main portion of the antenna in the clear because of its length. This means that the power lost by bringing the antenna right in to the transmitter is relatively small.

Even so, it is not the best practice to bring the business part or high-voltage end of an antenna in to the operating room, especially for phone operation, because of the possibility of r.f. feedback from the strong antenna field. For this reason, one should dispense with a feed line in conjunction with a Hertz antenna only as a last resort.

END-FED ANTENNAS

The end-fed Fuchs (pronounced "Fooks") antenna has no form of transmission line to couple the antenna to the transmitter, but brings the radiating portion of the antenna right down to the transmitter where some form of coupling system is used to transfer energy to the antenna.

This antenna is always voltage-fed and always consists of an even number of quarter wavelengths. There has been considerable reference to end-fed, *current-fed* Hertz antennas, but it should be pointed out that they are neither end-fed nor Hertz antennas, being Marconi antennas fed somewhere above the ground end. Figure 10 shows several common methods of feeding the Fuchs antenna or end-fed Hertz.

The Fuchs type of antenna has rather high losses unless at least three-quarters of the radiator can be placed outside the operating room and in the clear. As there is high r.f. voltage at the point where the antenna enters the operating room, the insulation at that point should be several times as effective as the insulation commonly used with low-voltage feeder systems. This antenna can be

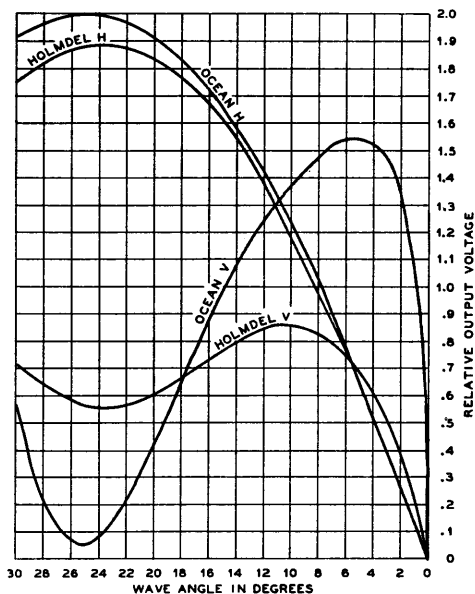

Figure 9. Vertical-plane directional characteristics of horizontal and vertical doublets elevated 0.6 wavelengths and above two types of ground.

operated on all of its higher harmonics with good efficiency, and can be operated at half frequency against ground as a quarter-wave Marconi.

If the system is operating properly as an end-fed Hertz, there will be high r.f. voltage at the point P.

THE MARCONI ANTENNA

A grounded quarter-wave antenna is widely used on the 160-meter band due to the fact that a half-wave antenna at that low frequency is around 260 feet long, which is out of the question for those confined to an ordinary city lot. It is also widely used in mobile five-meter applications where a compact radiator is required.

The Marconi-type antenna allows the use of half of the length of wire used for a half-wave Hertz radiator. The Marconi antenna is not as satisfactory for long-distance communication as the Hertz type, and the antenna efficiency is never as great, due to the losses in the ground connection. However, it can be made almost as good a radiator on 160 meters if sufficient care is taken with the ground system.

The fundamental Marconi antenna is shown in figure 11, and all Marconi antennas differ from this only in the method of feeding energy. Antenna A in figure 12 is the fundamental vertical type. Type B is the inverted-L type; type C is the T type with the two halves of the top portion of the T effectively in parallel.

The Marconi antenna should be as *high as possible*, and too much attention cannot be paid to getting a *good ground*.

Importance of Ground Connection

With a quarter-wave antenna and a ground, the antenna current is generally measured with a meter placed in the antenna circuit close to the ground connection. Looking at this meter, it is not at all difficult to picture the flow of current into the ground. Now, if this current flows through a resistor, or if the ground itself presents some resistance, there will definitely be a power loss in the form of heat. Improving the ground connection, therefore, provides a definite means of reducing the loss of antenna power, of increasing radiated power.

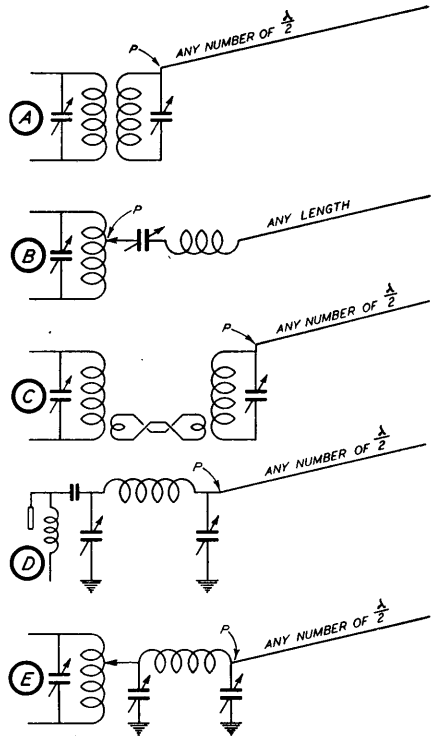

Figure 10. Five methods of end-feeding an antenna.

The best possible ground consists of as many wires as possible, each at least a quarter wave long, buried just below the surface of the earth and extending out from a common point in the form of radials. Copper wire of any size larger than no. 16 is satisfactory, though the larger sizes will take longer to corrode through. In fact, the radials need not even be buried; they may be supported just above the earth and insulated from it. This arrangement is called a *counterpoise*, and operates by virtue of its high capacity to ground.

Unless a large number of radials are used, fairly close to the ground, the counterpoise will act more like the bottom half of a half-wave Hertz than like a ground system. However, the efficiency with a counterpoise will be quite good regardless. It is when the radials are buried or laid on the ground that a large number should be used for best efficiency.

When it is impossible to extend buried radials in all directions from the ground connection for an inverted L-type Marconi, it is of importance that a few wires be buried directly below the flat top and spaced at least 10 feet from one another.

Should the antenna be physically shorter than a quarter wavelength, antenna current would be higher, due to lower radiation resistance, consequently, the power lost in resistive soil would be greater. The importance of a good

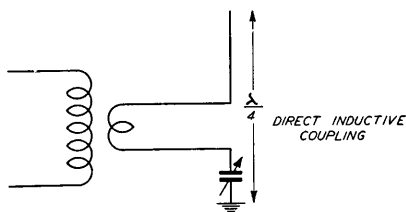

Figure 11. The series-tuned $\frac{1}{4}$ -wave Marconi, the basic Marconi antenna system.

ground with short inductive-loaded Marconi radiators is, therefore, quite obvious. With a good ground system, even very short antennas can be expected to give upwards from 90% of the efficiency of a quarter-wave antenna used with the same ground system.

Water-Pipe Grounds

A piece of water pipe, because of its physical size, has about as low an r.f. resistance as copper wire. If it is possible to attach to a junction of several water pipes (where they branch in several directions and run for some distance under ground), a satisfactory ground connection will be obtained. If one of the pipes attaches to a lawn or garden sprinkler system in the immediate vicinity of the antenna, and runs hither and thither to several neighboring faucets within a radius of a hundred yards, the effectiveness of the system will approach that of buried copper radials.

Chief objection to water pipe grounds is the possibility of high resistance joints

in the pipe due to the dope put on the coupling threads. By attaching to a junction with three or more legs, the possibility of requiring the main portion of the r.f. current to flow through a high-resistance connection is greatly reduced.

Contrary to popular opinion, the presence of water in the pipe adds but little to the conductivity; it, therefore, does not relieve the problem of high-resistance joints. Bonding the joints is the best insurance, but this is, of course, impracticable where the pipe is buried. Bonding together the various water faucets in your yard above the surface of the ground with copper wire will improve the effectiveness of a water pipe ground system hampered by high-resistance pipe couplings.

Radiator Length

A Marconi antenna is exactly an odd number of electrical quarter-waves long (usually only $\frac{1}{4}$ wave in length), which is the same thing as saying that a Marconi is always resonated to the operating frequency. The loading adjustment is accomplished by varying the coupling rather than by detuning the antenna from resonance.

Physically, a quarter-wave Marconi may be made anything from one-eighth to nearly three-eighths wavelength overall, meaning the total length of the antenna wire and ground lead from the end of the antenna to the point where the ground lead attaches to the junction of the radials or counterpoise wires. The longer the antenna is made physically, the higher will be the radiation resistance, the lower will be the current flowing in the ground connection and the greater will be the overall radiation efficiency. However, when the antenna length approaches three-eighths wavelength, the antenna becomes difficult to resonate by means of a series condenser, and it begins to take shape as an end-fed Hertz, requiring a different method of feed than that illustrated in figure 11 for current feed of a Marconi.

A radiator physically shorter than a quarter wavelength can be lengthened electrically by means of a series loading coil, and used as a quarter-wave Marconi. However, if the wire is made shorter than approximately one-eighth wavelength, the radiation resistance will

be so low that good efficiency cannot be obtained.

To resonate an inductive-loaded Marconi, the inductance would have to be in the form of a variometer in order to permit continuous variation of the inductance. The more common practice is to use a tapped loading coil and a series tuning condenser. More than the required amount of inductance for resonance is clipped in series with the antenna, and the system is then resonated by means of the series variable condenser the same as though the radiator were actually too long physically.

To estimate whether a loading coil will probably be required, it is necessary only to note if the length of the antenna wire and ground lead is over a quarter wavelength; if so, no loading coil should be required, provided the series tuning condenser has a high maximum capacity.

Amateurs primarily interested in the higher frequency bands but who like to work 160 meters for an occasional local ragchew can usually manage to resonate one of their antennas as a Marconi by working the whole system, feeders and all, against a water pipe ground and

resorting to a loading coil if necessary. A high-frequency zepp, doublet or single-wire-fed antenna will make quite a good 160-meter Marconi if high and in the clear, with a rather long feed line to act as a radiator on 160 meters. Where two-wire feeders are used, the feeders should be tied together for Marconi operation.

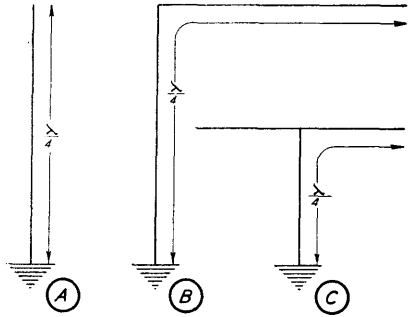

Figure 12. Three common variations of the Marconi-type antenna.

TRANSMISSION LINES

It is desirable to place a radiator as high and in the clear as possible, utilizing some form of nonradiating transmission line to carry energy with as little loss as possible from the transmitter to the radiating antenna.

There are many different kinds of transmission lines, and generally speaking, practically any type of transmission line or feeder system can be used with any type of antenna; however, certain types are often better adapted than others for use with a certain antenna.

Transmission lines are of two general types: resonant and nonresonant. Strictly speaking, the term *transmission line* should really only be applied to a *non-resonant line*. Strictly speaking, a *resonant line* should be termed a *feeder system*, such as zepp feeders, etc.

The principal types of nonresonant transmission lines include the single-wire-feed, the two-wire open and the twisted-pair matched impedance, the

coaxial (concentric) feed line and the multiwire matched-impedance open line.

Voltage Feed and Current Feed

The half-wave Hertz antenna has high voltage and low current at each end, and it has low voltage and high current at its center. As any ungrounded resonant antenna consists merely of one or more half-wave antennas placed end to end, it will be seen that there will be a point of high r.f. voltage every half wave of length measured from either end of the antenna. Also, there will be a point of high r.f. current halfway between any two adjacent high-voltage points.

A voltage-fed antenna is any antenna which is excited at one of these high-voltage points or, in other words, a point of high impedance. Likewise, a current-fed antenna is one excited at a point along the antenna where the cur-

rent is high and the voltage low, which corresponds to a point of low impedance.

THE ZEPPEL ANTENNA

The zepp antenna system is very widely used, due to the fact that it is rather easy to tune up and can be used on several bands by merely retuning the feeders. The overall efficiency of the zepp antenna system is probably not quite as high for long feeder lengths as some of the antenna systems which employ nonresonant transmission lines, but where space is limited and where operation on more than one band is desired, the zepp has some decided advantages.

Zepp feeders really consist of an additional length of antenna which is folded back on itself so that the radiation from the two halves cancels out. In figure 13A is shown a simple Hertz antenna fed at the center by means of a pickup coil. Figure 13B shows another half-wave radiator tied directly on one end of the radiator shown in figure 13A. Figure 13C is exactly the same thing except that the first half-wave radiator, in which is located the coupling coil, has been folded back on itself. In this particular case, each half of the folded part of the antenna is exactly a quarter-wave long electrically.

Addition of the coupling coil naturally will lengthen the antenna, electrically;

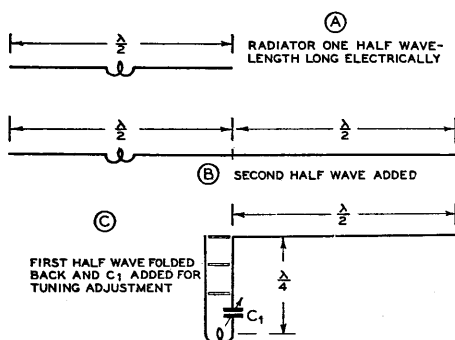

Figure 13. The evolution of a zepp antenna. (A) Radiator one-half wave long electrically, current-fed at center. (B) Second half-wave added. (C) First half-wave folded back on itself, C_1 added for tuning adjustment.

thus, in order to bring this portion of the antenna back to resonance, we must electrically shorten it by means of the series tuning condenser, C_1 . The two wires in the folded portion of the antenna system do not have to be exactly a quarter wave long physically although the total *electrical* length of the folded portion must be equal to one-half wavelength electrically.

When the total electrical length of the two feeder wires plus the coupling coil is slightly greater than any odd multiple of one-half wave, then series condensers must be used to shorten the electrical length of the feeders sufficiently to establish resonance. If, on the other hand, the electrical length of the feeders and the coupling coil is slightly less than any odd multiple of one-half wave, then parallel tuning must be used wherein a condenser is shunted across the coupling coil in order to increase the electrical length of the whole feeder system to a multiple of one-half wavelength.

As the radiating portion of the zepp-antenna system must always be some multiple of a half wave long, there is always high voltage present at the point where the live zepp feeder attaches to the end of the radiating portion of the antenna. Thus, this type of zepp-antenna system is *voltage-fed*.

The idea that it takes two condensers to balance the current in the feeders, one condenser in each feeder, is a common misconception regarding the zepp-type end-fed antenna. Balancing the feeders with tuning condensers for equal currents is useless anyhow, inasmuch as the feeders on an end-fed zepp can never be balanced for *both* current *and* phase because of the dead feeder.

The condition will be most nearly met when the flat top is of the correct length, and if the flat top is of the correct length, no juggling of the individual feeders is required. *One* tuning condenser in *one* of the feeders is all that is required; it will not unbalance the system any more than it is already unbalanced as a result of having one dead feeder; a condenser in each feeder does nothing to restore the balance of a system that is inherently unbalanced as a whole.

It is impossible to remove, completely all radiation from the feeders of an end-fed zepp antenna. For the reason that it is of no particular disadvantage to allow the feeders to do a *little* radiating on

their own, and because some feeder radiation will be present regardless, the zepp-antenna system may be operated over a range of about 5 per cent each side of the resonant frequency of the flat-top radiator.

THE TUNED DOUBLET

A current-fed doublet with spaced feeders, sometimes erroneously called a center-fed zepp, is an inherently balanced system (if the two legs of the radiator are exactly equal electrically) and there will be no radiation from the feeders regardless of what frequency the system is operated on. A series condenser may be put in *one* feeder without affecting the balance of the system. The system can successfully be operated on most any frequency if the system as a whole can be resonated to the operating frequency. This is usually possible with a tapped coil and a tuning condenser that can optionally be placed either across the antenna coil or in series with it.

This type of antenna system is shown in figure 14. It is a current-fed system on the lowest frequency for which it will operate, but becomes a voltage-fed system on all its even harmonics.

When operated on harmonics, this antenna has a different radiation pattern, as would be expected. The arrangement used on the second harmonic is better known as the Franklin colinear array and is described later in this chapter. The pattern is similar to a half-wave doublet except that it is sharper in the broadside direction. On higher harmonics there will be multiple lobes.

TUNED FEEDER CONSIDERATIONS

If a transmission line is terminated in its characteristic surge impedance, there will be no reflection at the end of the line and the current and voltage distribution will be uniform along the line. If the end of the line is either open-circuited or short-circuited, the reflection at the end of the line will be 100 per cent, and *standing waves* or voltage variation will appear on the line. There will still be no radiation from the line, but voltage nodes will be found along the wire spaced a half

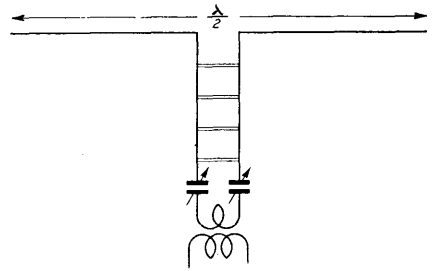

Figure 14. The tuned doublet, using an open line. A condenser in only one feeder may be used if desired.

wavelength. Likewise, voltage loops will be found every half wavelength, the voltage loops corresponding to current nodes.

When the line is terminated in some value other than the characteristic surge impedance, there will be some reflection, the amount being determined by the amount of mismatch. With reflection, there will be standing waves or excursions of current and voltage along the line, though not to the same extent as with an open-circuited or short-circuited line. The current and voltage loops will occur at the same *points* along the line, and as the terminating impedance is made to approach the characteristic impedance of the line, the current and voltage along the line will become more uniform. The foregoing assumes, of course, a purely resistive (nonreactive) load.

A well-built 400- to 600-ohm transmission line may be used as a resonant feeder for lengths up to several hundred feet with very low loss, so long as the amplitude of the standing waves (ratio of maximum to minimum voltage along the line) is *not too great*. The amplitude, in turn, depends upon the mismatch at the line termination. A line of no. 12 wire, spaced 6 inches with good ceramic spreaders, has a surge impedance of approximately 600 ohms, and makes an excellent tuned feeder for feeding anything between 60 and 6000 ohms. If used to feed a load of higher or lower impedance than this, the standing waves become great enough in amplitude that some loss will occur unless the feeder is kept short.

A transmission line which is not per-

fectly matched should be made *resonant*, even though the amplitude of the standing waves (voltage variation) is small. This prevents reactance from being coupled into the final amplifier. A tuned feed system may be made to present a nonreactive load to the amplifier either by tuning or pruning the feeders to resonance.

It is usually preferable with tuned feeders to have a current loop (voltage minima) at the transmitter end of the line. This means that when voltage-feeding an antenna the tuned feeders should be made an odd number of quarter wavelengths long, and when current-feeding an antenna the feeders should be made an even number of quarter wavelengths long. Actually, the feeders are made about 10 per cent of a quarter wave longer than the calculated value (the same value given in the tables) when they are to be series tuned to resonance by means of a condenser instead of being trimmed and pruned to resonance.

When tuned feeders are used to feed an antenna on more than one band, it is necessary to compromise and make provision for both series and parallel tuning, inasmuch as it is impossible to cut a feeder to a length that will be optimum for several bands. If a voltage loop appears at the transmitter end of the line on certain bands, parallel tuning of the feeders will be required in order to get a transfer of energy. It is impossible to transfer energy by inductive coupling unless current is flowing. This is effected at a voltage loop by the presence of the resonant tank circuit formed by parallel tuning of the antenna coil.

Methods of coupling to a transmitter are discussed later in the chapter.

UNTUNED TRANSMISSION LINES

A nonresonant or untuned line is a line which does not possess standing waves. Physically, the line itself should be *identical throughout its length*; there will be a smooth distribution of voltage and current throughout its length, both gradually tapering off slightly towards the antenna end of the line as a result of line losses. The attenuation (loss) in certain types of untuned lines can be kept very low for the line lengths of

several thousand feet. In other types, particularly where the dielectric is not air (such as in the twisted-pair line), the losses may become excessive at the higher frequencies unless the line is relatively short.

The termination at the antenna end is the only critical characteristic about the untuned line. It is the reflection from the antenna end which starts waves moving back toward the transmitter end. When waves moving in both directions along a conductor meet, standing waves are set up.

All transmission lines have distributed inductance, capacity and resistance. Neglecting the resistance, as it is of minor importance in short lines, it is found that the *inductance and capacity*

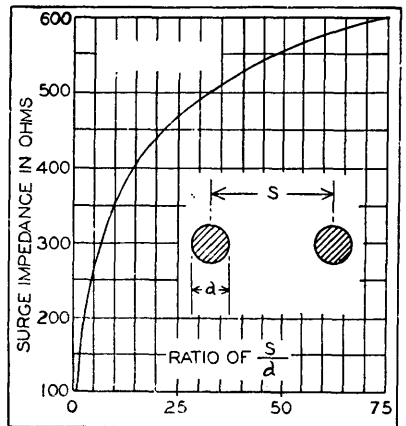
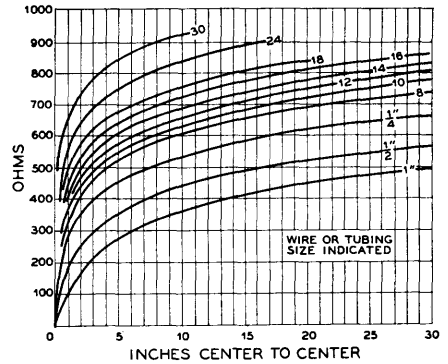

Figure 15. Conductor size and spacing versus surge impedance for two-wire open line or matching transformer.

per unit length determine the characteristic or surge impedance of the line. Thus, the surge impedance depends upon the nature and spacing of the conductors and the dielectric separating them.

When any transmission line is terminated in an impedance equal to its surge impedance, reflection of energy does not occur and no standing waves are present. When the load termination is exactly the same as the line impedance, it simply means that the load takes energy from the line just as fast as the line delivers it, no slower and no faster.

Thus, for proper operation of an untuned line (with standing waves eliminated), some form of impedance-matching arrangement must be used between the transmission line and the antenna so that the radiation resistance of the antenna is reflected back into the line as a nonreactive impedance equal to the line impedance. It is important that the radiator itself be cut to exact resonance; otherwise, it will not present a pure resistive load to the nonresonant line.

An untuned feeder system may consist of one, two, four or even more parallel wires. Increased constructional difficulties of the multiwire type of line where three or more parallel wires are used and the danger of appreciable feeder radiation from an improperly-adjusted single-wire feeder make the more familiar two-wire type of line the most satisfactory for general use.

If four, six, eight and even greater numbers of wires are used, it is possible to secure a somewhat lower surge impedance than is possible with the more conventional two-wire line.

Two-Wire Open Lines

A two-wire transmission system is easy to construct. Its surge impedance can be calculated quite easily, and when properly adjusted and balanced to ground, undesirable feeder radiation is minimized since the current flow in the adjacent wires is in opposite directions and the magnetic fields of the two wires are in opposition to each other. When a two-wire line is terminated with the equivalent of a pure resistance equal to the surge impedance of the line, the line becomes a nonresonant line. It is, then, the problem to find a way to go about calculating the surge impedance of any two-wire transmission line, which impedance we will call Z_s .

Wire gauge Number B & S	Wire Diameter in Inches
2	.257
4	.204
6	.162
8	.1285
10	.1019
12	.0808
14	.0641
16	.0508
18	.0403

Figure 16. Necessary data for computation of surge impedance of any two-wire open line.

It can be shown mathematically that the true surge impedance of any two-wire parallel line system is approximately equal to

$$Z_s = 276 \log_{10} \frac{2S}{d}$$

Where:

S is the exact distance between wire centers in some convenient unit of measurement, and

d is the diameter of the wire measured in the same units as the wire spacing, S .

Since $\frac{2S}{d}$ expresses a ratio only, the

units of measurement may be centimeters, millimeters or inches. This makes no difference in the answer so long as the substituted values for S and d are in the same units.

The equation is surprisingly accurate so long as the wire spacing is relatively large as compared to the wire diameter.

Surge impedance values of less than 200 ohms are seldom used in the open-type two-wire line and, even at this comparatively high value of Z_s , the wire spacing S is uncomfortably close, being only 5.3 times the wire diameter d .

Figure 15 gives in graphical form the surge impedance of any practicable two-wire line. The chart is self-explanatory and sufficiently accurate for practical purposes.

Twisted-Pair Untuned Line

Low-loss, low-impedance transmission cable (such as EO1) allows a very flexible transmission line system to be used to convey energy to the antenna from the transmitter. The low-loss construction

is largely due to the use of untinned, solid conductors, low-loss insulation, plus a good grade of weatherproof covering. The older twisted flex cables used by amateurs had quite high losses and should be avoided.

A twisted-pair line should always be used as an untuned line as standing waves on the line will produce excessive losses and can easily break down the line insulation.

For turning sharp corners and running close to large bodies of metal, the twisted pair is almost as good at the lower frequencies as the coaxial line whose cost unfortunately places it out of reach of the average amateur at the present time.

Above 14 Mc., however, the rubber insulation causes appreciable dielectric loss, and the twisted-pair type of low-impedance line should not be used except where the length is short or where concentric tubing might not be suitable from a mechanical standpoint, as in certain types of rotary arrays.

The low surge impedance of the twisted-pair transmission line is due not only to the close spacing of the conductors, but to the rubber insulation separating them. The latter has a dielectric constant considerably higher than that of air, which not only lowers the surge impedance but also results in slower propagation of a wave along the conductors. This results in the voltage loops occurring closer together on the line when standing waves are present

than for an open-wire line working at the same frequency.

Coaxial Line

Lately, coaxial cable has come into wide use for connecting an antenna to the transmitter. A cross-sectional end view of a coaxial cable is shown in figure 17.

As in the parallel-wire line, the power lost in a properly-terminated line is the sum of the effective resistance losses along the length of the cable and the dielectric losses between the two conductors. In a well-designed line, both are negligible, the actual measured loss in a good line being less than 0.5 db per 1000 feet at one megacycle.

Of the two losses, the effective resistance loss is the greater; since it is largely due to the skin effect, the line loss (all other conditions the same) will increase directly as the square root of the frequency. Such lines are almost always made of soft copper tubing having a very low d.c. resistance, which, with the large conductor surface available (high-frequency currents tend to travel on the surface of a conductor), will make the line losses of negligible importance for the line lengths normally used.

Figure 17 shows that, instead of having two conductors running side by side with each other, one of the conductors is placed *inside* of the other. Because of this, the line has been termed the *concentric*, or more correctly, *coaxial* transmission line. Since the grounded outside conductor completely shields the inner one, no radiation takes place.

The conductors may both be tubes, one within the other, or the line may consist of a solid wire within a tube. In either case, the inner conductor is supported at regular intervals from the outside tube by a circular insulator of either pyrex or some nonhygroscopic ceramic material with low high-frequency losses. The insulators are slipped over the inner conductor and held in place either by some system of small clamps or by crimping the wire immediately in front of and behind each insulator. If the insulator fits snugly over the inside conductor, this latter method is to be preferred, as the mean or average distance of the outside diameter of the inside conductor from that of the inside diameter of the outside con-

COMPARATIVE R. F. FEEDER LOSSES

FREQUENCY	DB LOSS PER 100 FT.	TYPE OF LINE
7 Mc.	0.9	150-ohm impedance, rubber insulated twisted-pair with outer covering of braid.
14 Mc.	1.5	
30 Mc.	3	
7 Mc.	0.4	W. E. 3/8" concentric pipe feeder with inner wire on bead spacers. Impedance, 70 ohms.
30 Mc.	0.9	
7 Mc.	0.05	Open 2-wire line no. 10 wire. Impedance, 440 ohms.
30 Mc.	0.12	
7 Mc.	3	Twisted no. 14 solid weatherproof wire, weathered for six months (telephone wire).
14 Mc.	4 1/2	
30 Mc.	8	

ductor remains more uniform, and the calculated results will be more accurate than if some other system using clamps or small metal collars to hold the insulating spacers were used.

Moisture must be kept out of the tube if best results are to be secured. It is, therefore, necessary to solder or otherwise to join tightly the line sections together so that no leak occurs. This prevents water from seeping into the line in outdoor installations.

To avoid condensation of moisture on the inside walls of the line, it is the general practice to fill the line with dry nitrogen gas at a pressure of approximately 35 pounds per square inch.

Filling a line with dry nitrogen gas also greatly increases its power capacity, a power capability rating of three to one being quite common for the nitrogen-filled line as compared to a line operating under normal atmospheric pressures.

Nearby metallic objects cause no loss and the cable can be run up air ducts, wire conduit or elevator shafts just as easily as a flexible hose. Insulation troubles can be forgotten. The coaxial cable may be either buried in the ground or suspended above ground.

This characteristic makes the coaxial cable valuable where transmitter installations must be made in large buildings, as in the case with a majority of police transmitters. Even at frequencies as high as 100 megacycles, line losses can be kept within tolerable limits. For the smaller powers, flexible coaxial cable can be secured in line lengths up to several hundred feet, thus doing away with the need for couplings or sections.

MATCHING NON-RESONANT LINES

The most practical open-wire untuned line is one having a surge impedance of from 400 to 600 ohms. Unfortunately, it is seldom that the antenna system being fed has a radiation resistance of similar value. It is sometimes necessary with current-fed antennas to match the line to an impedance as low as 8 or 10 ohms, while with voltage-fed antenna systems and arrays it is occasionally necessary to match the line to an impedance of many thousands of ohms. There are many ways of accomplishing

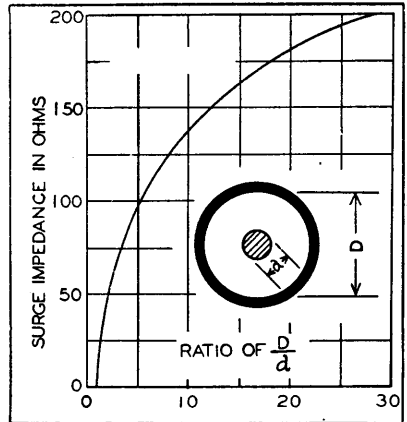

Figure 17. Curve for determination of surge impedance of any coaxial line.

this, the more common and most satisfactory methods being discussed here.

Delta-Matched Antenna System

The delta matched-impedance antenna system is quite widely used. Figure 18 shows this feeder system. The impedance of the transmission line is transformed gradually into a higher value by the fanned-out Y portion of the feeders, and the Y portion is tapped on the antenna at points where the antenna impedance equals the impedance at the ends of the Y.

The constants of the system are rather critical, and the antenna must resonate at the operating frequency in order to get the standing waves off the line. Some slight readjustment of the taps on the antenna is desirable if standing waves persist in appearing on the line.

The constants are determined by the following formulas:

$$L_{\text{reel}} = \frac{467.4}{F \text{ megacycles}}$$

$$D_{\text{reel}} = \frac{175}{F \text{ megacycles}}$$

$$E_{\text{reel}} = \frac{147.6}{F \text{ megacycles}}$$

where L is antenna length; D is the distance *in from each end* at which the Y taps on; E is the height of the Y section.

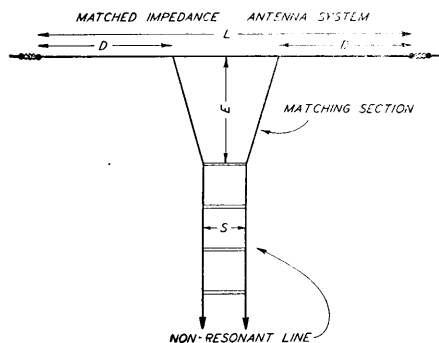

Figure 18. The delta-matched antenna system. For dimensions see page 81.

As these constants are correct only for a 600-ohm transmission line, the spacing S of the line must be approximately 75 times the diameter of the wire used in the transmission line. For no. 14 B & S wire, the spacing will be slightly less than 5 inches. For no. 12 B & S, the spacing should be 6 inches and for no. 10 B & S wire, the spacing should be $7\frac{1}{2}$ inches to make the surge impedance of the line 600 ohms. Note that the distance D is quite close to three-eighths (0.375) of the antenna length. This feeder system should never be used on either its even or odd harmonics as entirely different constants are required when more than a single half-wavelength appears on the radiating portion of the system.

Single-Wire-Fed Antenna

The matched-impedance single-wire-fed antenna system is quite satisfactory where the length of the transmission line may be kept short. The losses are somewhat higher than for the two-wire types of transmission lines, but are not serious for lengths up to a few hundred feet.

A single-wire feed has a characteristic surge impedance of from 500 to 600 ohms, depending upon the diameter of the feeder wire. This type feeder makes use of the earth as a return circuit through the earth's capacity effect to the antenna and feeder. The actual earth connection to the transmitter may have a relatively high resistance without causing appreciable loss of r.f. energy. The impedance of the feeder is a great many times more than the 5- to 30-ohm

radiation resistance of a Marconi antenna at the ground connection. The additional resistance of a few ohms at the earth connection produces a large power loss in the latter case, but relatively little loss in the case of single-wire feed due to the smaller amount of current flowing.

The single-wire feeder should be tapped to either side of a *current loop* in a resonant antenna at a point of proper impedance match.

The current loop occurs at the center of a half-wave antenna and at the center of each half-wave section in a long-wire antenna. The impedance at this current loop is approximately 73 ohms for most half-wave antennas (varying with height above ground). In order to match perfectly the 500- or 600-ohm impedance of the feeder, it is necessary to connect it to the antenna at a point approximately one-seventh of the total length of the antenna wire either side of center. There will be no standing waves on the feeder when the impedances are perfectly matched, and maximum efficiency will then result.

This point of perfect impedance match, unfortunately, is not suitable for harmonic operation of the antenna. By having a small impedance mismatch at the fundamental frequency, the single-wire-fed antenna can be used on several harmonically-related short-wave bands. The feeder should be connected to the antenna at a point one-sixth rather than one-seventh, of the total length of the antenna wire either side of center. A simple manner in which to find this point is to divide the antenna into three equal lengths, and then connect the feeder to the antenna at a point which is a third of the total length from either end.

This all-wave type of antenna-feeder connection results in a slight mismatch (not enough to be serious) on the fundamental frequency of operation.

In a perfectly matched design at the fundamental frequency of operation, the impedance mismatch is very great when the antenna is operated on its harmonics. It is better to compromise by connecting the feeder to the antenna as shown in figure 19.

It is almost impossible to find a combination that will allow the standing waves to be entirely eliminated on two or more bands with this antenna, but tuned

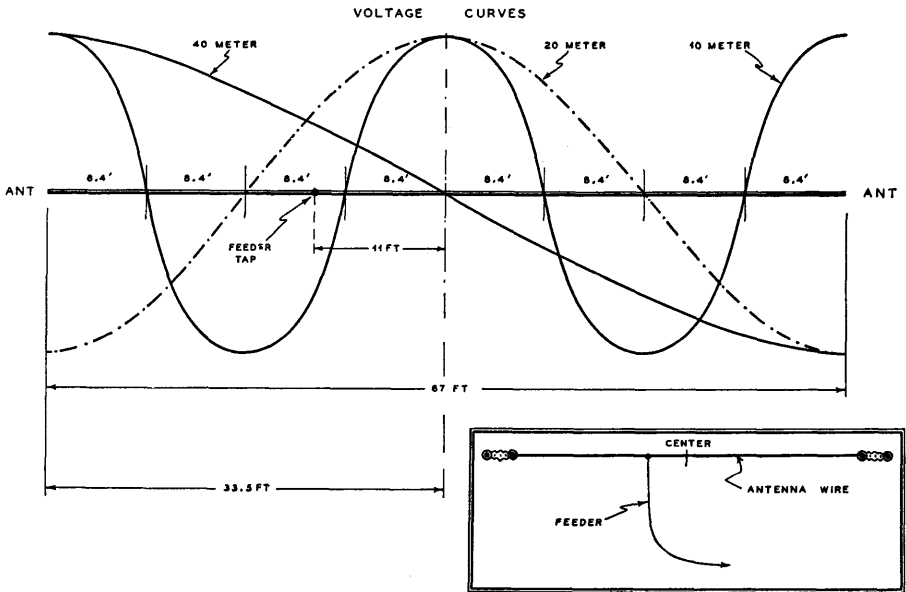

Figure 19. Single-wire-fed antenna for all-band operation. An antenna of this type for 40-, 20- and 10-meter operation would have a radiator 67 feet long, with the feeder tapped 11 feet off center. The feeder can be 33, 66 or 99 feet long. The same type of antenna for 80-, 40-, 20- and 10-meter operation would have a radiator 134 feet long, with the feeder tapped 22 feet off center. The feeder can be either 66 or 132 feet long. This system should be used only with those coupling methods which provide good harmonic suppression.

up for the higher frequency band it will give satisfactory results on the next lower frequency band.

The effect on the final amplifier of small standing waves on the feeder can be practically eliminated by making the feeder some multiple of a quarter wave in length. The impedance at the station end will then be purely resistive and no detuning effect will be evident in the final amplifier circuit when the feeder is either connected or disconnected from the amplifier. The formula for calculating a feeder length in feet is:

$$l = \frac{234,000}{f_1}$$

where l is the feeder length in feet, f_1 is the lowest frequency of operation in kilocycles.

The length of the antenna wire in figure 19 is also a compromise for all-band operation. The harmonics of an antenna wire for any given length are

not exact multiples due to the *end effects* of the antenna.

A wire cut for 3,600 kc. will be a little short for operation as a full-wave antenna on 7,200 kc., which is the second harmonic of 3,600 kc. Fortunately, the single-wire-fed antenna can be operated satisfactorily over a band of frequencies wide enough that this effect is no handicap.

The antenna wire should be cut so that it will resonate at the *middle of the highest frequency band desired* on its fourth harmonic; this gives the best compromise for operation in three harmonically related bands. The method of calculation will be found on page 63; quick reference tables are also given, making it easy to calculate the proper radiator length for harmonic operation.

These multiband single-wire-fed antennas are generally designed for three bands of operation, such as 80, 40 and 20, or 40, 20 and 10 meters.

A single-wire feeder for all-band operation should preferably be some

multiple of a quarter wave (of the lowest frequency band) in length. For single-band operation, the feeder can be any length *provided it is attached to the antenna at the point of exact impedance match*, as indicated by an absence of standing waves. When a single-wire-fed antenna is to be used on just one frequency, it is desirable to adjust the feeder by cut-and-try methods.

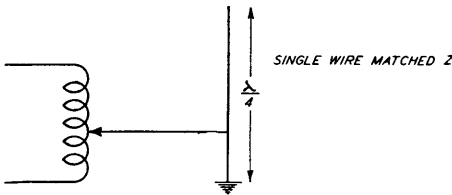

Figure 20. Marconi with single-wire feed.

The feeder should always run at right angles to the antenna wire proper for a distance of at least a sixth wavelength at the lowest frequency of operation. A good "earth" ground connection should be made to the transmitter for most effective operation of a single-wire feeder though it need not be as elaborate as for a Marconi antenna.

It is often desirable to feed a grounded Hertz or Marconi antenna with a single-wire feeder. Figure 20 shows such an arrangement. The feeder can be tapped about 14% of a half wave up from the ground point. This type of antenna does not operate well on its harmonics and is principally used on 30, 60 and 120 megacycles.

The radiation resistance of a T or inverted-L Marconi antenna is somewhat less than the theoretical 36-ohm value for a grounded quarter-wave antenna; in some cases, especially where the antenna is short and loading is required, it may run as low as 10 ohms. However, the resistance of the ground connection in an amateur installation is usually high enough to bring the resultant resistance up in the vicinity of 25-30 ohms, thus permitting a satisfactory impedance match with standard 30-ohm coaxial cable.

Y-Matched Antenna System

It is not good practice to attempt to match a transmission line of less than about 100 ohms to a dipole by means of the delta-matching system previously described.

For this reason, the Y match is used for the twisted-pair transmission line where the surge impedance of the line does not exactly equal the radiation resistance of the antenna being fed. The feeders are fanned out into a small equilateral triangle where they attach to the antenna, the required amount of fanning being determined by the difference between the line impedance and radiation resistance. As the latter will depend upon many factors and is difficult to estimate accurately, the best degree of fanning for a particular antenna and line can best be determined by experiment. With correct fanning, standing waves will be at a minimum and no trouble will be had from heating of the line at the crotch of the Y when high power is used.

The Y-matched antenna is not quite so critical as to frequency as is the delta-matched antenna, and can be used with success on its odd harmonics.

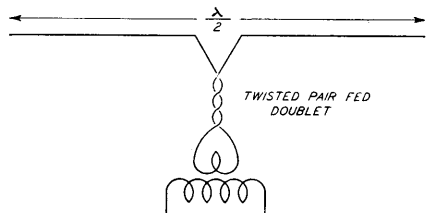

Figure 21. Illustrating the Y-matching method.

MATCHING STUBS

It is possible to hang a resonant length of Lecher wire line (called a matching stub) from either a voltage or current loop and attach 600-ohm nonresonant feeders to the resonant stub at a suitable voltage (impedance) point. The stub is made to serve as an autotransformer. Thus, by putting up a half-wave zapp

Frequency Kilocycles	$L = \frac{467.4}{F_{mc}} = \frac{.95\lambda}{2}$ feet	$D = \frac{175}{F_{mc}}$ feet	$E = \frac{147.6}{F_{mc}}$ feet
3500	133' 7"	50'	42' 2"
3600	129' 10"	48' 7"	41'
3700	126' 4"	47' 4"	39' 11"
3800	123'	46' 1"	38' 10"
3900	119' 10"	44' 9"	37' 11"
3950	118' 4"	44' 3"	37' 5"
4000	116' 10"	43' 9"	36' 11"
7000	66' 9"	25'	21' 1"
7050	66' 4"	24' 10"	20' 11"
7100	65' 10"	24' 8"	20' 9"
7150	65' 4"	24' 6"	20' 7.5"
7200	64' 11"	24' 4"	20' 6"
7250	64' 6"	24' 2"	20' 4.5"
7300	64'	24'	20' 3"
14,000	33' 5"	12' 6"	10' 6"
14,100	33' 2"	12' 5"	10' 5"
14,200	32' 11"	12' 4"	10' 4"
14,300	32' 9"	12' 3"	10' 3.5"
14,400	32' 6"	12' 2"	10' 3"
28,000	16' 8.5"	75"	63"
28,500	16' 5"	74"	62"
29,000	16' 1.5"	72.5"	61"
29,500	15' 10.5"	71"	60"
30,000	15' 7.5"	70"	59"
56,000	100"	37.5"	31.5"
57,000	98.4"	37"	31"
58,000	96.5"	36"	30.5"
59,000	94.8"	35.5"	30"
60,000	93"	35"	29.5"

DIMENSIONS FOR DELTA MATCHED-IMPEDANCE ANTENNA SYSTEM.

The delta matched-impedance antenna system is an old stand-by that has withstood the test of time. When properly adjusted, the losses are as low as for any antenna system it is possible to construct, and lower than most of the ones in common use. The main drawback is that it is inherently a one-band affair. The dimensions L, D and E refer to figure 18.

The dimensions are quite critical, and the values given above should be closely adhered to, then altered slightly, if necessary, for the particular installation until there is no trace of standing waves on the line. Usually, slight adjustment of the dimension D will remove any trace of standing waves; this should be tried first.

with quarter-wave feeders at a distance from the transmitter and attaching a 600-ohm line from the transmitter to the zapp feeders at a suitable point, we have a stub-matched antenna. The example cited here is commonly called a J antenna, especially when both radiator and

stub are vertical. Many variations from this example are possible; stubs are particularly adapted to matching an open line to certain directional arrays as will be described later in this chapter.

When the stub attaches to the antenna at a voltage loop, the stub should be a quarter wavelength long electrically and be shorted at the bottom end. The stub can be resonated by sliding the shorting bar up and down before the nonresonant feeders are attached to the stub, the antenna being shock-excited from a separate radiator during the process. Slight errors in the length of the radiator can be compensated for by adjustment of the stub if both sides of the stub are connected to the radiator in a symmetrical manner. Where only one side of the stub connects to the radiating system, as in the J antenna example given here, the radiator length must be exactly right in order to prevent excessive unbalance in the untuned line.

If only one leg of a stub is used to voltage-feed a radiator, it is impossible to secure a perfect balance in the transmission line due to a slight inherent unbalance in the stub itself when one side is left floating. This unbalance, previously discussed under the *zapp antenna system*, should not be aggravated by a radiator of improper length.

When a stub is used to current-feed a radiator, the stub should either be left open at the bottom end instead of shorted or else made a half wave long. The open stub should be resonated in the same manner as the shorted stub before attaching the transmission line; however, in this case, it is necessary to prune the stub to resonance as there is no shorting bar.

Sometimes it is handy to have a stub hang from the radiator to a point that can be reached from the ground in order to facilitate adjustment of the position of the transmission-line attachment. For this reason, a quarter-wave stub is sometimes made three-quarters wavelength long at the higher frequencies in order to bring the bottom nearer the ground. Operation with any odd number of quarter waves is the same as for the quarter-wave stub.

Any number of half waves can be added to either a quarter-wave stub or a half-wave stub without disturbing the operation though losses will be lowest if the shortest usable stub is employed.

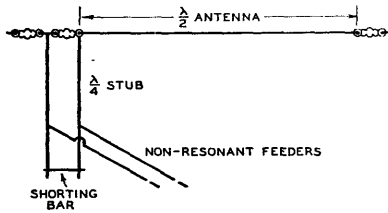

(A) Half-wave antenna with quarter-wave matching stub.

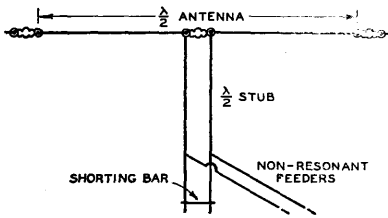

(B) Center-fed half-wave antenna with half-wave matching stub.

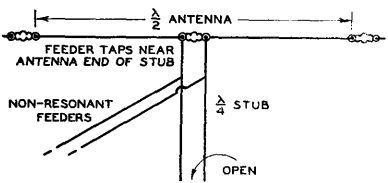

(C) Center-fed half-wave antenna with stub line cut to exact length without shorting bar.

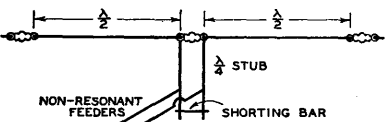

(D) Two half-wave sections in phase with quarter-wave stub.

FIGURE 22. MATCHING-STUB APPLICATIONS.

This can be fully understood by inspection of the accompanying table.

<i>Stub Length (Electrical)</i>	<i>Current-Fed Radiator</i>	<i>Voltage-Fed Radiator</i>
$\frac{1}{4}$ - $\frac{3}{4}$ - $1\frac{1}{4}$ -etc. wavelengths	Open	Shorted
$\frac{1}{2}$ - 1 - $1\frac{1}{2}$ - 2 -etc. wavelengths	Shorted	Open

Shorted-Stub Tuning Procedure

When the antenna requires a shorted stub (odd number of quarter waves if the antenna is voltage-fed; even number of quarter waves if radiator is current-fed), the tuning procedure is as follows:

Shock-excite the radiator (or one of the half-wave sections if harmonically operated) by means of a makeshift doublet strung directly underneath where possible and just off the ground a few inches, connected to the transmitter by means of any kind of twisted pair or open line handy.

With the feeders and shorting bar disconnected from the stub, slide along an r.f. milliammeter or low-current dial light at about where you calculate the shorting bar should be and find the point of maximum current (in other words, use the meter or lamp as a shorting bar). It is best to start with reduced power to the transmitter until you see how much of an indication you can expect; otherwise, the meter or lamp may be blown on the initial trial. The leads on the lamp or meter should be no longer than necessary to reach across the stub.

After finding the point of maximum current, remove the lamp or meter and solder a piece of wire across the stub at that point.

Starting at a point about a quarter of a quarter wave (8 feet at 40 meters) from the shorting bar, connect the feeders to the stub. Then, move the feeders up and down the stub until the standing waves on the line are at a minimum. The makeshift doublet should, of course, be disconnected and the regular feeders connected to the transmitter instead during this process.

When checking for standing waves, take readings no closer than several feet to the stub as the proximity of the stub will affect the reading of the standing-wave indicator and lead one to false conclusions. The standing-wave indicator

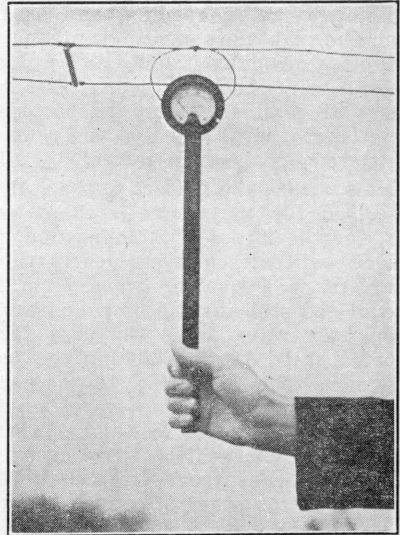

Figure 23. A simple "standing-wave detector" may consist of either an r.f. thermogalvanometer or a 0-1-ma. d.c. milliammeter connected in series with a carborundum crystal rectifier (detector). A pickup coil of from two to six turns is mounted as shown and the whole affair attached to a stick in order to minimize body capacity. The device is moved along the feeder or line, indicating any variation in current along the line. The pickup coil must be held in the same relationship to the line as it is moved along the line if accurate results are desired.

may be either a voltage device, such as a neon bulb, or a current device, such as an r.f. milliammeter connected to a three-turn pickup coil. A high degree of accuracy is not required.

Open-Ended Stub Tuning Procedure

If the antenna requires an open stub (even number or quarter waves if the antenna is voltage-fed; odd number of quarter waves if radiator is current-fed), the tuning procedure is as follows:

Shock-excite the radiator as described for tuning a shorted-stub system, feeders disconnected from the stub and stub cut slightly longer than the calculated value. Place a field strength meter (the standing-wave indicator can be very easily converted into one by addition of a tuned tank) close enough to one end of the

radiator to get a reading, and as far from the makeshift exciting antenna as possible. Now, start folding and clipping the stub wires back on themselves a few inches at a time, effectively shortening their length, until you find the peak as registered on the field meter.

Now, attach the feeders to the stub as described for the shorted-stub system,, but, for the initial trial connection, the feeders will attach more nearly three-quarters of a quarter wave from the end of the stub instead of a quarter of a quarter wave as is the case for a shorted stub. After attaching the feeders, move them along the stub as necessary to remove standing waves on the line. If sliding the feeders along the stub a few inches makes the standing waves worse, it means the correct connecting point is in the other direction.

LINEAR TRANSFORMERS

Q-Matching Section

A resonant quarter-wave line has the unusual property of acting much as a transformer. Let us take, for example, a quarter-wave section consisting of no. 12 wire spaced six inches, which happens to have a surge impedance of 600 ohms. Let the far end be terminated with a pure resistance and let the near end be fed with radio-frequency energy at the frequency for which each feeder is a quarter wavelength long. If an impedance measuring set is used to measure the impedance at the near end while the impedance at the far end is varied, an interesting relationship between the 600-ohm characteristic surge impedance of this particular quarter-wave matching line and the impedance at the two ends will be discovered.

When the impedance at the far end of the line is the same as the characteristic surge impedance in the line itself (600 ohms), the impedance measured at the near end of the quarter-wave line will also be found to be 600 ohms.

Under these conditions, the line would not have any standing waves on it due to the fact that it is terminated in its characteristic impedance. Now, let the resistance at the far end of the line be doubled, or changed to 1200 ohms. The impedance measured at the near end of the line will be found to have been cut in

half and is now 300 ohms. If the resistance at the far end is made half the original value of 600 ohms, or 300 ohms, the impedance at the near end doubles the original value of 600 ohms and becomes 1200 ohms. Therefore, as one resistance goes up, the other goes down proportionately.

It will always be found that the characteristic surge impedance of the quarter-wave matching line is the geometric mean between the impedance at both ends. This relationship is shown by the following formula:

$$Z_{MC} = \sqrt{Z_A Z_L}$$

where

Z_{MC} = Impedance of matching section.

Z_A = Antenna resistance.

Z_L = Line impedance.

Johnson-Q Feed System

The standard form of Johnson-Q feed to a doublet is shown in figure 24. An impedance match is obtained by utilizing a matching section whose surge impedance is the geometric mean between the transmission line surge impedance and the radiation resistance of the radiator. A sufficiently good match can usually be obtained by either designing or adjusting the matching section for a dipole to have a surge impedance that is the geometric mean between the line impedance and 72 ohms, the latter being the theoretical radiation resistance of a half-wave doublet either infinitely high or a half wave above a perfect ground.

Though the radiation resistance may depart somewhat from 72 ohms under actual conditions, satisfactorily good results will be obtained with this assumed value so long as the dipole radiator is more than a quarter wave above effective earth and reasonably in the clear. The small degree of standing waves introduced by a slight mismatch will not increase the line losses appreciably, and any *small* amount of reactance present can be tuned out at the transmitter termination with no bad effects.

A Q-matched system can be adjusted precisely, if desired, by constructing a matching section to the calculated dimensions with provision for varying the spacing of the conductors slightly after the untuned line has been checked for standing waves.

The Q section will usually require about 200 ohms surge impedance when

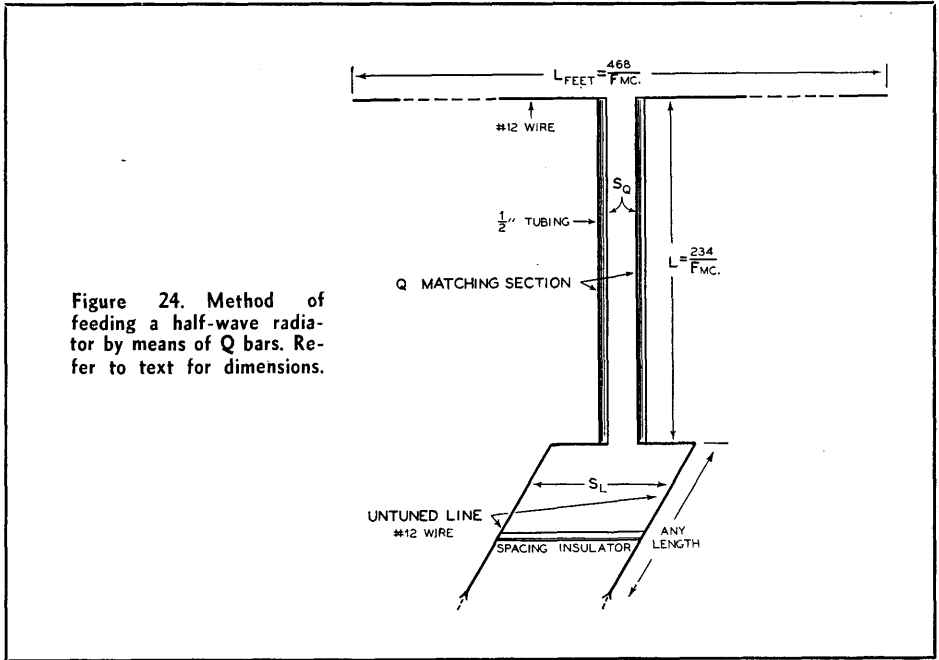

used to match a half-wave doublet, actually varying from about 150 to 250 ohms with different installations. This impedance is difficult to obtain with a two-wire line as very close spacing would be required. For this reason, either a four-wire line or a line consisting of two half-inch aluminum tubes is ordinarily used. The four-wire section has the advantage of lightness and cheapness, while the aluminum tubing arrangement possesses the advantage of being readily adjustable to different values of surge impedance by means of adjustable spacing insulators.

The four-wire section can be used to advantage where the approximate radiation resistance is known with certainty, thus making it possible to design the matching section for a certain value of surge impedance with some assurance that it will turn out to be sufficiently accurate.

Construction with Aluminum Tubes

The apparent complexity of the Q-matched dipole comes from the large number of antennas and line combinations which the Q section is able to match. By eliminating all but the most common

combinations, all the spacing data can be placed in one simple table.

The length of the flat top or radiating portion of the half-wave Q-fed antenna equals 468 divided by the frequency in *megacycles*. The answer is in feet. The length of the Q bars will be exactly half the total length of the flat-top radiator, or 234 divided by the frequency in *megacycles*. The formulas are shown in the diagram.

The untuned transmission line between the transmitter and the input, or lower end of the Q section, can be any length (within reason).

Use no. 12 B & S gauge wire for both

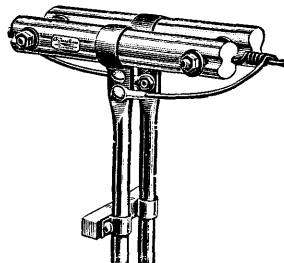

Figure 25. Pictorial sketch of Johnson Q.

SPACING UNTUNED LINE	SPACING Q BARS
2"	1 3/16"
4"	1 3/8"
6"	1 7/16"

Table of spacing for half-wave Q-antenna system using no. 12 wire in untuned line and half-inch Q bars. Spacings given are center-to-center.

the flat top and the untuned line. Use half-inch aluminum or copper tubing for the Q section. Use either two-, four- or six-inch spacing between conductors of the untuned line. There is little choice between them.

After choosing one of these three untuned line spacings, pick it out on the accompanying table; opposite it you will find the proper center-to-center spacing of the Q bars. Subtract one-half inch from the center-to-center spacing and you will get the surface spacing of the Q bars. The regular Q-antenna kit includes a spacing tool calibrated in center-to-center spacings.

Construction with Four-Wire Transformer

The reduction in impedance obtained by the use of four wires instead of two makes the four-wire line highly useful for matching transformer applications. For instance, the order of impedances ordinarily required for Q-matching sections is easily obtained by spacing four wires around a circular insulating spacer of suitable diameter.

Plastic iced-tea coasters of the correct diameter can be used for spacers. They are quite inexpensive, and where the exact desired size cannot be obtained, some choice as regards surge impedance is possible because one is not necessarily restricted to any particular wire size and some change in surge impedance is obtained by using one size larger or smaller wire.

When purchasing the coasters, one should take precaution to get the correct type of material. It seems that some are made from bakelite, while others are made of a plastic that has much better insulation qualities than bakelite; the bakelite ones show up rather poorly at the high frequencies. The plastic ones

can easily be identified: they are translucent, while the bakelite ones are not.

The spacers should be oriented so that they will not collect water when it rains. The wires of the matching section can be secured to the spacers by means of short serving wires a few inches long. This method is much simpler than using screws or clamps, and just as satisfactory. Incidentally, it is simpler to drill four holes around the edge of the coasters and insert the *serving wires* through the holes than it is to thread the coasters along the four wires of the matching section.

The line is flexible and must be used

CORRECT VALUES OF SURGE IMPEDANCE OF $\lambda/4$ MATCHING SECTIONS FOR DIFFERENT LENGTHS OF ANTENNAS

Antenna Length in Wave-length	Surge Impedance for Connection Into Two-Wire Open Lines with Impedance of		
	500 Ohms	580 Ohms	600 Ohms
1/2	190	210	212
1	210	230	235
2	235	252	257
4	255	277	282
8	280	300	305

Matching section connects into center of a current loop such as middle of a half-wave section.

under slight tension to keep the wires from twisting. Spacers should be placed approximately every two feet. The diagonally opposite wires should be connected together at each end of the 4-wire section.

Designing a Four-Wire Q Section

Assuming that the antenna is resonant at the operating frequency, there are two values that must be known to calculate the impedance of the quarter-wave matching transformer. These are the

PARALLEL TUBING SURGE IMPEDANCE FOR MATCHING SECTIONS.

Center to Center Spacing in Inches	Impedance in Ohms for 1/2" Diameters	Impedance in Ohms for 1/4" Diameters
1	170	250
1.25	188	277
1.5	207	298
1.75	225	318
2	248	335

Frequency in Kilocycles	Quarter-wave matching section or stub	Half-wave Radiator	Dis. from end of radiator to feeder tap
	$\frac{234}{F_{me}} = \frac{.95\lambda}{4} = N$	$\frac{467.4}{F_{me}} = \frac{.95\lambda}{2} = L$	$D = \frac{169.2}{F_{me}}$ (single-wire feed)
3500	66' 10"	133' 7"	48' 4"
3600	64' 11"	129' 10"	46' 8"
3700	63' 2"	126' 4"	45' 7"
3800	61' 6"	123'	44' 6"
3900	59' 11"	119' 10"	43' 3"
3950	59' 2"	118' 4"	42' 8"
4000	58' 5"	116' 10"	42' 1"
7000	33' 5"	66' 9"	24' 2"
7050	33' 2"	66' 4"	23' 11"
7100	32' 11"	65' 10"	23' 9"
7150	32' 9"	65' 4"	23' 7"
7200	32' 6"	64' 11"	23' 4"
7250	32' 3"	64' 6"	23' 3"
7300	32'	64'	23' 2"
14,000	16' 9"	33' 5"	12' 1"
14,100	16' 7"	33' 2"	12'
14,200	16' 5"	32' 11"	11' 10.5"
14,300	16' 4"	32' 9"	11' 9"
14,400	16' 3"	32' 6"	11' 8"
28,000	100"	16' 8.5"	72"
28,500	98.4"	16' 5"	71"
29,000	96.5"	16' 1.5"	70"
29,500	94.8"	15' 10.5"	69"
30,000	93"	15' 7.5"	68"
56,000	50"	100"	36"
57,000	49.2"	98.4"	35.5"
58,000	48.3"	96.5"	35"
59,000	47.4"	94.8"	34.5"
60,000	46.5"	93"	34"

DIMENSIONS FOR MATCHED-IMPEDANCE J, Q AND SINGLE-WIRE-FED ANTENNAS

Quick-reference guide for determining radiator and matching section or stub length for the J, Q and single-wire-fed antennas. Also, for determining the proper point at which to attach a single-wire feeder for optimum results for ONE-BAND operation. For operation on more than one band, the flat top should be cut for the highest frequency band and the single-wire feeder tapped one-third of the way in from one end, disregarding the figures given in the right-hand column of the above chart. The antenna will then work equally well on several bands with but a slight reduction in efficiency. The stub for a J should be adjusted as described under stub matching, after being cut slightly longer than the value given in the above table.

impedance of the antenna at the point where it is being fed and the impedance of the transmission line.

The center impedance of a 1/2-wave antenna can be taken as 75 ohms, 3/2-wave as 100 ohms, 5/2 wave as 115 ohms, and 7/2 wave as 125 ohms for calculation of the quarter-wave section.

Knowing the center impedance of the antenna and the impedance of the transmission line to which it must be matched, the characteristic impedance of the quarter-wave matching section can be calculated by the following formula:

$$Z_s = \sqrt{Z_a Z_l}$$

where Z_s is the impedance of the matching section, Z_a is the radiation resistance of the antenna and Z_l is the surge impedance of the transmission line between the transmitter and the matching section.

Then, as soon as the impedance of the matching section has been computed, upon referring to the chart of figure 26 indicating four-wire line impedances, the ratio of the spacing to the diameter of the wire used in the section can be found.

OPERATING AN ANTENNA ON ITS HARMONICS

Zepp-fed and direct-fed antennas have always been the most popular antennas for multiband operation. This is due to the fact that practically all of the antennas that are fed by nonresonant transmission lines reflect a bad mismatch into the line when operated on two, four or eight times the fundamental antenna frequency. Thus, the twisted-pair doublet, the Johnson Q, the matched-impedance J or T types, all are unsuitable for even-harmonic operation. The single-wire-fed antenna can be used with fair success on three bands, but it operates *properly* on only one band.

The radiating portion of an antenna does not resonate on integral harmonics of its fundamental frequency. This point is not generally appreciated. It is a common assumption that a half-wave antenna cut, for example, for 3500 kc. (133'7") resonates on all the integral harmonics of 3500 kc. and, thus, can be used on 7,000, 14,000, 28,000 and 56,000 kc. Actually, a half-wave antenna cut for 3500 kc. resonates as 7,185, 14,550, 29,210 and 58,760 kc. These frequencies are related by the formula

$$F = \frac{(K-.05) 492,000}{L}$$

where F is the frequency in kilocycles, K is the number of half waves on the antenna, L is the length of the antenna in feet.

In order to determine the harmonic frequencies at which a given antenna wire resonates, multiply by the factors shown here the frequency for which the antenna represents exactly a half wave.

	Multiply fundamental frequency by
Fundamental or first harmonic ...	1.000
Second harmonic	2.052
Third harmonic	3.106
Fourth harmonic	4.158
Eighth harmonic	8.390
Sixteenth harmonic	16.677

Thus, a wire which is a half wavelength long at 1,000 kilocycles resonates on its second harmonic at 2,052 kc.; third harmonic at 3,106 kc., etc.

When designing an antenna for operation on more than one band, it should be cut for harmonic resonance at its highest operating frequency. If it is to be operated off-resonance on some band, it is better to have it off-resonance on a low-frequency band because any errors then become a smaller percentage of a half wave.

COUPLING TO THE TRANSMITTER

When coupling either an antenna or antenna feed system to a transmitter,

the important considerations are as follows: (1) means should be provided for

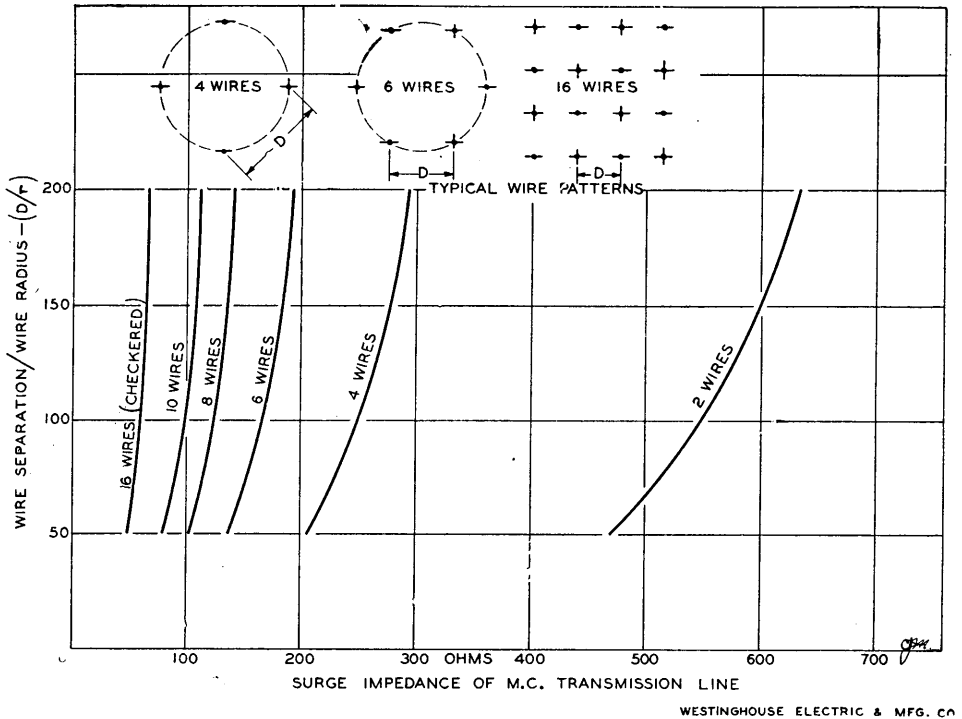

WESTINGHOUSE ELECTRIC & MFG. CO

Figure 26. Quick-reference chart for determination of surge impedance of multiconductor transmission line or matching transformer. D refers to the distance between adjacent wires, and R the radius of the wire itself. Wires of like polarity should be connected together at each end of the line or transformer.

varying the load on the amplifier, (2) the two tubes in a push-pull amplifier should be equally loaded, (3) the load presented to the final amplifier should be nonreactive; in other words, it should be a purely resistive load.

The first item is often erroneously referred to as "matching the feeder impedance to the transmitter" or "matching the impedance". There is really nothing to match; it is simply a matter of *loading*. The coupling is increased until the final amplifier draws the correct plate current. Actually, all the matching and mismatching we worry about pertains to the junction of the feeders and *antenna*. There is nothing that the operator can do at the station end of a transmission line to remove standing waves or correct an impedance mismatch between the antenna and the line. This point is often overlooked. There is no such thing as an

impedance mismatch at the station end between the line and the transmitter.

The matter of equal load on push-pull tubes can be taken care of by simply making sure that the coupling system is symmetrical, both physically and electrically. For instance, it is not the best practice to connect a single-wire feeder directly to the tank coil of a push-pull amplifier.

The third consideration, that of obtaining a nonreactive load, is important from the standpoint of efficiency, radiated harmonics, and voice quality in the case of a phone transmitter. If the feeders are clipped directly on the amplifier plate tank coil, either the surge impedance of the feeders must match the antenna impedance perfectly (thus avoiding standing waves) or else the feeders must be cut to exact resonance.

If an inductively-coupled auxiliary tank

is used as an antenna tuner for the purpose of adjusting load and tuning out any reactance, one need not worry about feeder length or complete absence of standing waves. For this reason, it is always the safest procedure to use such an antenna coupler rather than connect directly to the plate tank coil.

Function of an Antenna Coupler

The function of an output coupler is to transform the impedance of the feed line, or the antenna, into that value of plate load impedance which will allow the final amplifier to operate most effectively. The antenna coupler is, therefore, primarily an impedance transformer. It may serve a secondary purpose in filtering out harmonics of the carrier frequency. It may also tune the antenna system to resonance.

Practically every known antenna coupler can be made to give good results when properly adjusted. Certain types are more convenient to use than others, and the only general rule to follow in the choice of an antenna coupler is to use the simplest one that will serve your particular problem.

There is practically nothing that an operator can do at the station end of a transmission line that will either increase or decrease the standing waves on the line as that is entirely a matter of the coupling between the line and the antenna itself. However, the coupling at the station end of the transmission line has a very marked effect on the efficiency and the power output of the final amplifier in the transmitter. Whenever we adjust antenna coupling and thus vary the d.c. plate current on the final amplifier, all we do is vary the ratio of impedance transformation between the feed line and the tube plate (or plates).

Capacitive Coupling Methods

Figure 27 A to G shows several of the most common methods of capacitive coupling between final amplifier and feed line.

The fixed condenser C_b is a large capacity mica condenser in every case. It has no effect upon tuning or operation; it is merely a blocking condenser keeping high voltage d.c. off the transmission line.

Figure 27 A shows a simple method of coupling a single-wire nonresonant feeder

to an unsplit plate tank. The coupling is increased by moving the tap up toward the plate end of the plate tank coil.

The system shown in figure 27 B shows a means of coupling an untuned two-wire line to a split plate tank. If it is desired to couple a two-wire untuned line to an unsplit plate tank, it will be necessary to use some form of inductive coupling. See figure 28 K or O.

The circuit of figure 27 C shows one way to couple a single-wire feeder or an end-fed antenna to an unsplit plate tank.

The circuit of figure 27 D shows the same thing except a π -section filter is used in place of the series-tuning shown in figure 27 C.

Figure 27 E shows the two-wire version of the Collins coupler.

Figure 27 F is a simple and effective means of coupling a twisted-pair untuned line to a split plate tank. If it is desired to couple a twisted-pair line to an unsplit plate tank, it is preferable to use inductive coupling as in Figure 29 S.

Figure 27 G closely resembles figure 27 D and its operation is quite similar. It uses an L-section filter instead of a π section and is somewhat more difficult to adjust than that of figure 27 D.

Figure 27 H is very similar to the Collins of figure 27 D except that the plate tank coil and condenser are eliminated. The π network effectively acts as a plate tank and antenna coupler at the same time. This type of circuit can be used at any frequency, especially for screen-grid r.f. and grid-neutralized triode amplifiers. It is particularly suited for use in low-power portables or emergency gear where simplicity and versatility are required and some harmonic radiation can be tolerated. The more capacity at C_2 and the less at C_1 , the greater the impedance step-up between the line and the tube (and the looser the coupling). This holds true with all the π -section couplers, such as figure 27 D and figure 27 E, H and J.

The coupler shown in figure 27 I is similar in operation to the coupler of figure 27 H. Its only advantage is that series feed can be used to the final amplifier, and its main disadvantage lies in the fact that an insulated shaft must be used on the rotor of condenser C_1 in order to avoid hand capacity.

The circuit of figure 27 J is simply the push-pull version, for a two-wire line, of the coupler of figure 27 H.

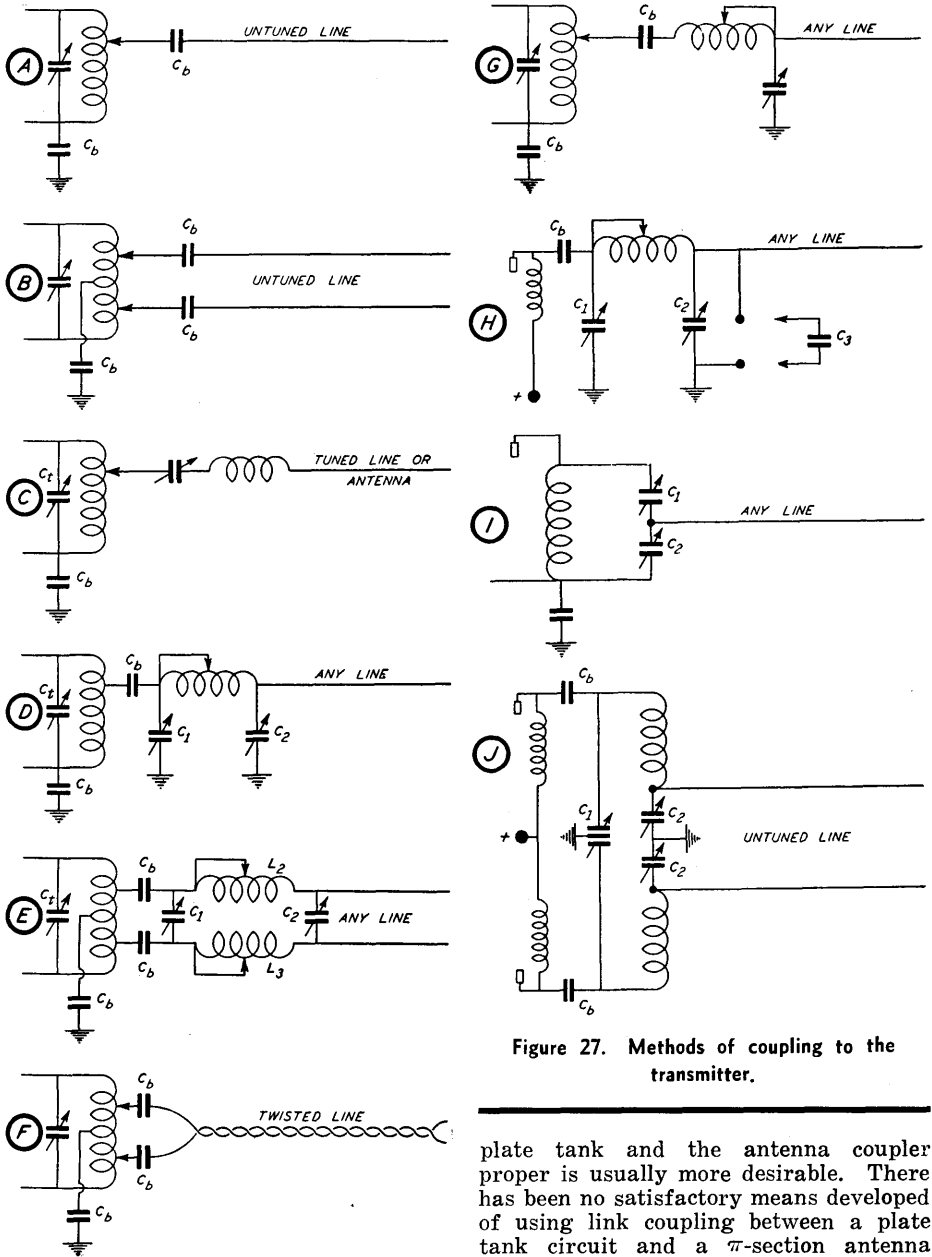

Figure 27. Methods of coupling to the transmitter.

Inductive Coupling

Inductive coupling methods may be classified in two types: direct inductive coupling and link coupling. Direct inductive coupling has been very popular for years, but link coupling between the

plate tank and the antenna coupler proper is usually more desirable. There has been no satisfactory means developed of using link coupling between a plate tank circuit and a π -section antenna coupler. Thus, if it is desired to use the π -section coupler, it will be necessary to use capacitive coupling as even direct inductive coupling is quite difficult to adjust. There is no effective means of coupling a single-wire feeder to a push-pull amplifier by means of the π -section coupler. Circuit of figure 28 K shows direct

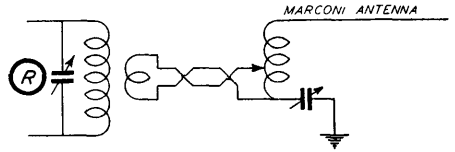
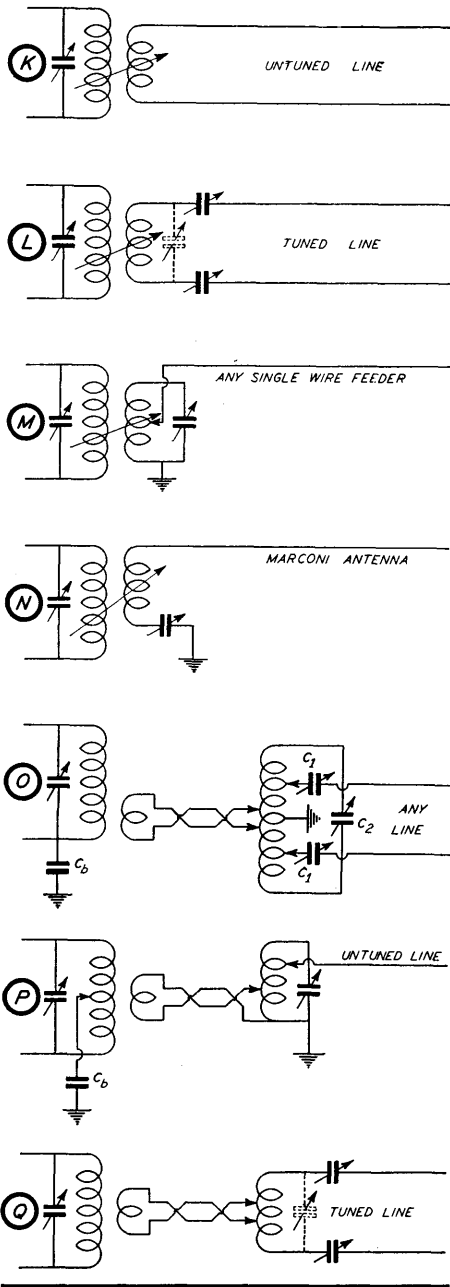

Figure 28. Antenna coupling systems.

the conventional method of coupling a zepp or tuned feed line to a plate tank circuit, but the arrangements shown in figure 28 O or figure 28 Q are easier to adjust. Circuit shown in figure 28 M is for coupling a single-wire tuned or untuned feeder to either a split- or unsplit-plate tank circuit. The arrangement shown in figure 28 P is easier to adjust. The circuit shown in figure 28 N is the conventional means of coupling a Marconi or grounded quarter-wave Hertz to a plate tank circuit. But the circuit shown in figure 28 R is considered more desirable.

Figure 28 O shows link coupling between a plate tank and any two-wire line, tuned or untuned. If untuned, condensers C_1 can be eliminated. As drawn, the circuit shows an unsplit-plate tank, but the same circuit can be used with a split-plate tank provided the coupling link is coupled to the center of the tank coil instead of the lower end. All coupling links anywhere in a transmitter should be coupled at a point of low r.f. potential to avoid undesired capacitive coupling.

The arrangement of figure 28 P is used to couple an untuned single-wire line to either a split- or unsplit-tank circuit. The diagram shows a split-tank circuit, but the operation is the same in either case. The link must be moved down to the cold end of the plate coil if an unsplit-tank is used.

The arrangement of figure 28 Q is used to couple a zepp or tune a two-wire line to either a split- or unsplit-plate tank circuit.

The circuit shown in figure 28 R illustrates one means of coupling a Marconi antenna to either a split- or unsplit-plate tank circuit.

Figure 29 S illustrates a method of coupling a twisted-pair line to an unsplit-plate tank. Figure 29 T shows a means of coupling an untuned single-wire feeder to a plate-neutralized amplifier. This sometimes leads to neutralizing difficulties

inductive coupling to an untuned two-wire line. This same arrangement can be used to couple from a split-plate tank to a single-wire untuned feeder by grounding one side of the antenna coil.

The circuit shown in figure 28 L is

due to the fact that the neutralizing coil is not part of the tuned circuit.

Figure 29 U shows how a Faraday screen can be placed between the plate tank coil and a direct, inductively-coupled antenna coil in order to reduce capacitive coupling between the two circuits. Figure 29 V shows how the Faraday screen is made. The screen can take the form of a piece of cardboard on which the screening wires are held by means of varnish or lacquer. Half-inch spacing between adjacent wires in the Faraday screen is usually satisfactory. The wires must be connected together at just one end in order to avoid circulating current in the screen with resultant losses. This screen is very effective in reducing harmonic radiation when due to capacitive coupling.

Tuning Pi-Section Filter

To get good results from the π -section antenna coupler, certain precautions must be followed. The ratio of impedance transformation in π networks depends on the ratio in capacity of the two condensers C_1 and C_2 .

The first step in tuning is to disconnect the π -section coupler from the plate tank entirely. Then, apply low plate voltage and tune the tank condenser C_t (figure 27, D and E) to resonance. Remove the plate voltage and tap the π -section connection or connections approximately half-way between the cold point on the coil and the plate or plates. Adjust C_2 to approximately half maximum capacity and apply plate voltage. Quickly adjust C_1 to the point where the d.c. plate current dips indicating resonance.

At the minimum point in this plate current dip, the plate current will either be higher or lower than normal for the final amplifier. If it is lower, it indicates that the coupling is too loose; in other words, there is too high a ratio of impedance transformation. The plate current can be increased by *reducing* the capacity of C_2 and then restoring resonance with condenser C_1 . At no time after the π -section coupler is attached to the plate tank should the plate tuning condenser be touched. If the d.c. plate current with C_1 tuned to resonance is too high, it may be reduced by *increasing* the capacity of C_2 in small steps, each time restoring resonance with condenser C_1 .

Should the plate current persist in being too high even with C_2 at maximum capacity, it indicates either that C_2 has too low maximum capacity or that the π -section filter input is tapped too close to the plate of the final amplifier. If the plate current *cannot* be made to go high enough even with condenser C_2 at minimum capacity, it indicates that the input of the π -section is not tapped close enough to the plate end of the plate tank coil.

When the two-wire arrangement of figure 27 E is operating properly, the load on both tubes should be the same

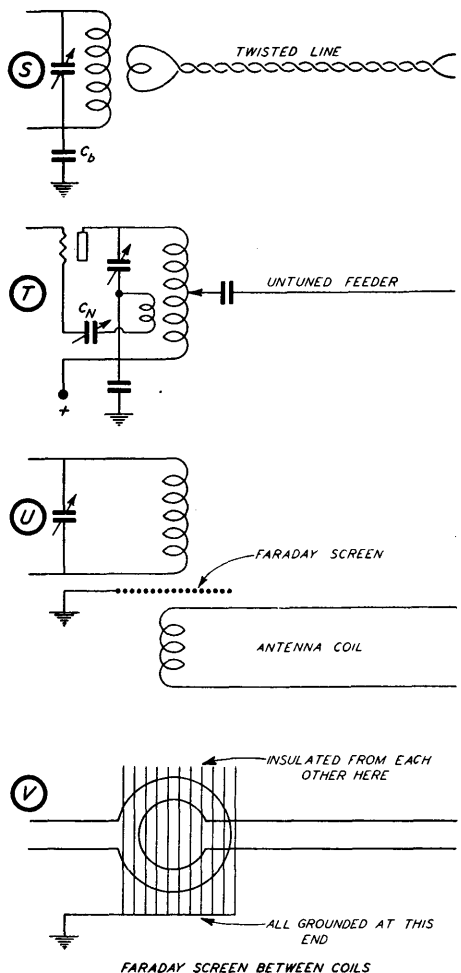

Figure 29. Further methods of coupling to the transmitter.

and there should be an equal spark (with a pencil) on each side of C_2 . Likewise, the arcs that can be drawn from each end of the plate tank coil should be the same. If they are not, it indicates an unsymmetrical condition of the push-pull stage or an unbalanced two-wire line.

This type of coupler will provide some attenuation of higher order harmonics if the adjustment is *precisely correct*. With even a slight amount of misadjustment the harmonics may actually be accentuated; therefore the tuning should be checked from time to time.

The simplified version, in which the coupler replaces the conventional tank instead of serving as an auxiliary unit, will produce rather strong harmonics even when correctly adjusted. Therefore, it should not be used except for emergency or low-power portable gear, as already mentioned.

SUPPRESSING HARMONIC RADIATION

Harmonics are present in the output of nearly all transmitters, though some transmitters are worse offenders in this respect than others. Those that are strong enough to be bothersome are usually the second and third harmonics.

Current-fed antennas, such as the twisted-pair-fed doublet and the Johnson Q-fed doublet, discriminate against radiation of the even harmonics. This is what keeps them from being used effectively as all-band antennas. However, they *are* responsive to the *odd* harmonics, working about as well on the third harmonic as on the fundamental. For this reason, any third harmonic energy present in the output of the transmitter will be radiated unless a harmonic trap is used or other means taken to prevent it.

Most all-band antennas are responsive to both odd and even harmonics, and they are still worse as regards the possibility of harmonic radiation.

The delta-matched antenna and radiators fed by means of a shorted stub and untuned line provide about the best discrimination against harmonics, but even these will radiate some third and other odd harmonic energy, and the odd harmonics always fall outside the amateur bands.

Best practice indicates the reduction of the amount of harmonic component in the transmitter output to as low a value

as possible, then further attenuation between the transmitter and antenna *regardless of what antenna and feed system is used*.

Three definite conditions must exist in the transmitter before harmonic radiation can take place. First, the final amplifier must either be generating or amplifying the undesired harmonics; second, the coupling system between the amplifier and the feeders or antenna system must be capable of transmitting them, and third, the antenna system (or its feeders) must be capable of radiating this harmonic energy.

One effective method of reducing capacity coupling is through the use of a Faraday shield. The Faraday shield, however, offers no attenuation to anything but *capacity coupling* of the undesired energy. Since a great deal of the harmonic energy (the third and other odd harmonics) is *inductively* coupled to the antenna system, an arrangement which will attenuate both capacitively and inductively coupled harmonics (both odd and even) would be desirable. A Faraday shield is not a cure-all. However, its performance is effective enough to warrant inclusion as standard equipment.

Such an arrangement is shown in figure 30. The link from the final tank to the antenna tank should consist of either a length of low-impedance cable (EO-1 or similar) or a *closely spaced* line of no. 12 or larger wire. This link should be loosely coupled by means of a single turn at either end to both tank circuits. One side of the link should be effectively grounded near the final tank. The antenna tank itself should be of medium C (a Q of about 10 or 12) at the operating frequency. At figure 30 C, the two links, the one to the final and the one to the antenna, should be spaced about two inches or so apart and at equal distances from the grounded center of the antenna coil. The balance of the diagram should be self-explanatory.

This coupling system operates by virtue of the fact that capacity coupling between the final tank and the antenna is eliminated by the grounded link and the grounded center tap of the antenna tank; also, due to the selectivity of the antenna tank against the harmonic frequencies, inductive coupling of them into the antenna system will also be attenuated.

In closing, a few general "don'ts" might be in order:

Don't use two tubes in parallel. Put them in push-pull if possible.

Don't use a doubler to feed an antenna unless it is of the push-push type. In a single-ended doubler, there is a high percentage of half and three-times frequency present in the output tank.

Don't use more bias and excitation than necessary for reasonable efficiency or (in a phone transmitter) good linearity.

Don't use a 75-meter zepp on 160 meters, a 40-meter zepp on 80 meters, etc. Although it is usually the odd harmonics that are inductively coupled, in this case the second harmonic will be inductively coupled and elimination of capacity coupling will not remove the second harmonic.

Don't use an all-band antenna unless you do not have room for separate antennas. If you must use such an antenna, use a harmonic-attenuating tank as shown in the accompanying diagrams.

Don't wait till you get a ticket for interfering with other services. Run a test with some local amateur close enough to give you an accurate check and see if your harmonics are objectionable.

A SIMPLE UNIVERSAL COUPLER

A split-stator condenser of 200 μfd . or more per section can be mounted on a small board along with a large and a small multitapped coil to make a very useful and versatile antenna coupler and harmonic suppressor. With this unit it is possible to resonate and load almost any conceivable form of radiator and tuned feed system and to adjust the loading and provide harmonic suppression with most any untuned transmission line.

To facilitate connecting the coil and condenser combination in the many different ways possible, 12 large-size dual Fahnestock connectors are mounted on the coils and condenser terminals and generously scattered around. Two are mounted on stand-off insulators to act as terminals for ground, antenna or other wires. A dozen lengths of heavy flexible wire of random lengths between 6 and 18 inches enable one to connect up the components in an almost infinite variety of combinations. Low-voltage auto ignition cable or heavy flexible hook-up wire will do nicely.

Because under certain conditions and in certain uses both rotor and stator will be hot with r.f., an insulated ex-

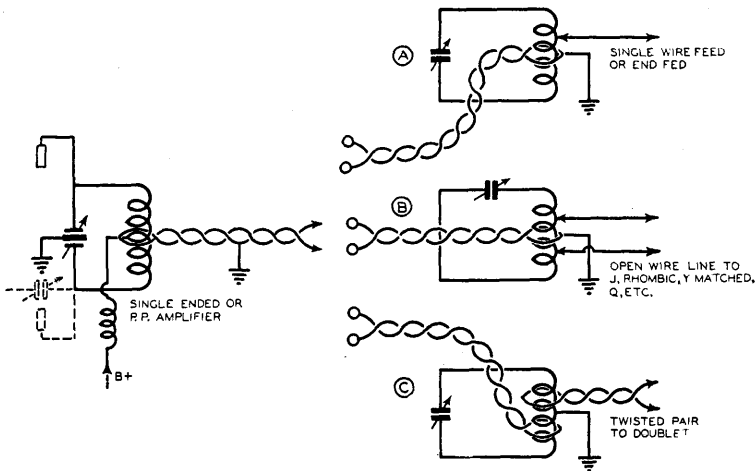

FIGURE 30. SIMPLE METHODS OF HARMONIC SUPPRESSION WITH AN AUXILIARY TANK CIRCUIT.

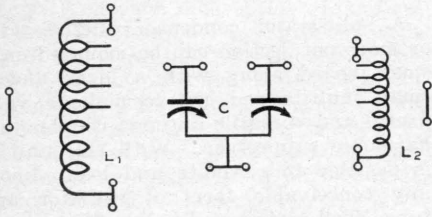

Figure 31. Circuit diagram of the coupler. For constants see text.

tension is provided for the condenser shaft in order to remove the dial from the condenser by a few inches. This effectively reduces body capacity. It also precludes the possibility of being bitten by the dial set-screw.

The large coil consists of 30 turns of no. 12 wire, 4 inches in diameter and spaced to occupy 5 3/4 inches of winding space. The small coil consists of 14 turns, 2 inches in diameter, spaced to occupy 3 1/4 inches of winding space. Both coils have tags brought out every other turn from one end to the center to facilitate clipping to the coils. A copper or brass clip is preferable to a steel clip for shorting-out turns as the circulating current may be quite high.

Rather than short-out too much of the large coil, we put the smaller coil into

service. In fact, the two coils can even be used together in series should the large coil alone ever lack sufficient inductance for any purpose. However, for every common application, the large coil alone should possess sufficient inductance.

Now to cover some of the things we can do with this simple contraption:

At A in figure 33 the unit is used as a harmonic suppression tank as advocated earlier in this chapter.

Combination B may be used for either an end-fed or center-fed zepp that requires parallel tuning. It may also be used to feed an untuned open line providing harmonic suppression. It may be used to tune an antenna-counterpoise system that has a higher natural frequency than that upon which it is desired to operate. It may be used with a multiband (Collins) antenna system where the feeders are too short. It may be used with any system utilizing tuned feeders where the system cannot be resonated with series tuning (see C).

Combination C may be used for either an end-fed or center-fed zepp that requires series tuning. It may be used to feed an antenna counterpoise system that is too long electrically to resonate at the operating frequency at its natural period. It may be used with a multiband antenna where the feeders are too long.

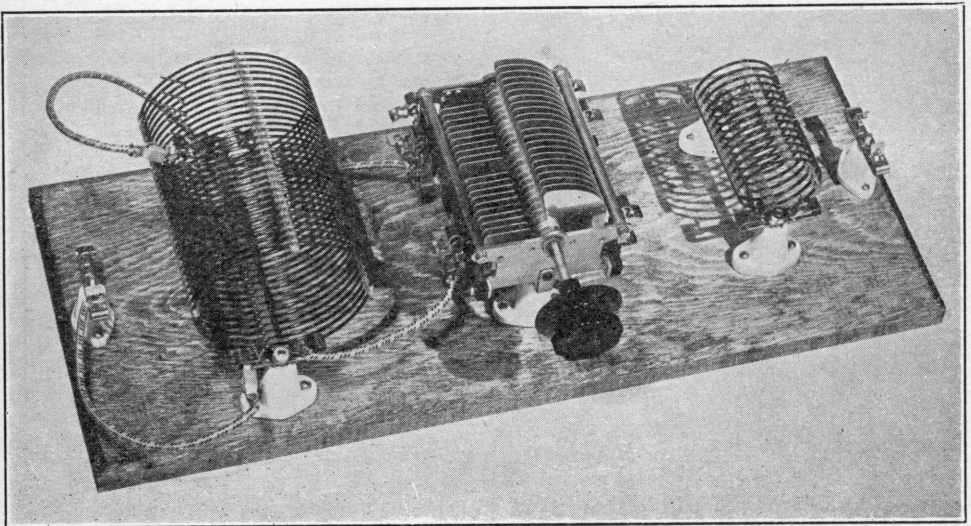

FIGURE 32. THIS UNIVERSAL ANTENNA COUPLER HAS MANY USES, IS SIMPLE AND INEXPENSIVE TO CONSTRUCT. ITS APPLICATIONS AND OPERATIONS ARE DISCUSSED ON PAGES 95, 96 AND 97.

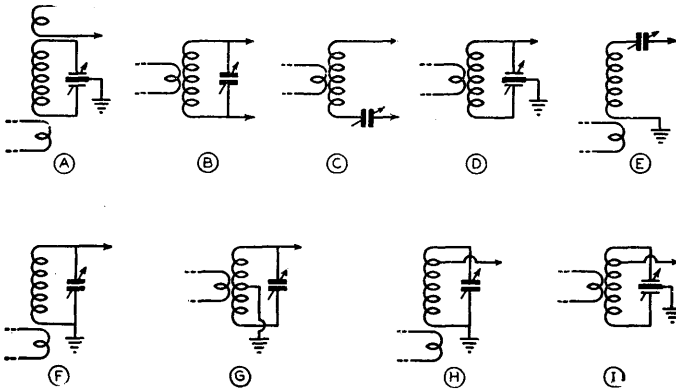

Figure 33. Applications of the universal antenna coupler.

It may be used for most any system utilizing tuned feeders where the system cannot be resonated using B.

Arrangement D may be used for feeding an end-fed antenna (even number of quarter waves long). It is usually preferable to F which is sometimes used for the same purpose.

System F also is used to tune a Marconi that is slightly shorter than an odd number of quarter waves long.

System E is the common method for tuning a Marconi where the antenna is slightly longer than an odd number of quarter waves.

G is commonly used to end-feed an antenna an even number of quarter waves long. It is a variation of D.

H and I are used for feeding either a single-wire-fed antenna or for end-feeding a very long-wire antenna (6 or more wavelengths long). For the latter purpose these are preferable to D, F and G.

In each case the link is coupled around the coil being used and one side of the twisted pair feeding the link is grounded.

DUMMY ANTENNAS

When testing a transmitter, the law requires the use of some form of dummy antenna to minimize unnecessary interference.

The cheapest form of dummy antenna is an electric light globe coupled to the plate tank circuit by means of a four- to eight-turn pickup coil (or even clipped directly across a few turns of the tank coil). Another good form of dummy antenna that is relatively nonreactive is a short thick bar of carbon tapped across enough of the tank turns to load the amplifier properly. The plaque form of wire-wound resistors also are ideal for use as a dummy antenna load.

If a lamp or lamps are chosen of such value that they light up to approximately normal brilliancy at normal transmitter input, the output may be determined with fair accuracy by comparing the brilliancy of the lamps with similar lamps connected to the 110-volt line.

DIRECTIVE PROPERTIES OF ANTENNAS

No antenna, excepting possibly a single vertical element (no reflectors), radiates energy equally well in all directions. All horizontal antennas have directional properties, the latter depend-

ing upon the length in wavelengths, the height above ground and the slope.

The various forms of the half-wave horizontal antenna produce maximum radiation at right angles to the wire,

but the directional effect is not very great excepting for very low vertical angles of radiation (such as would be effective on 10 meters). Nearby objects also minimize the directivity of a dipole radiator so that it hardly seems worth while to go to the trouble to rotate a simple half-wave dipole in an attempt to improve transmission and reception in any direction.

A half-wave doublet, zepp, single-wired, matched-impedance or Johnson-Q antenna all have practically the same radiation pattern when properly built and adjusted. They are all dipoles, and the feeder system should have no effect on the radiation pattern.

When a multiplicity of radiating dipoles are so located and phased as to reinforce the radiation in certain desired directions and to neutralize radiation in other undesired directions, a directive antenna array is formed.

The function of a directive antenna when used for transmitting is to give an increase in signal strength in some direction at the expense of reduced signal in other directions. For reception, one might find useful an antenna giving little or no gain in the direction from which it is desired to receive signals if the antenna is able to discriminate against interfering signals and static arriving from other directions. A good directive transmitting antenna, however, can generally also be used to good advantage for reception. This is covered in detail later in this chapter.

If radiation can be confined to a narrow beam, the signal intensity can be increased a great many times in the desired direction of transmission. This is equivalent to increasing the power output of the transmitter. It is more economical to use a directive antenna than to increase transmitter power if

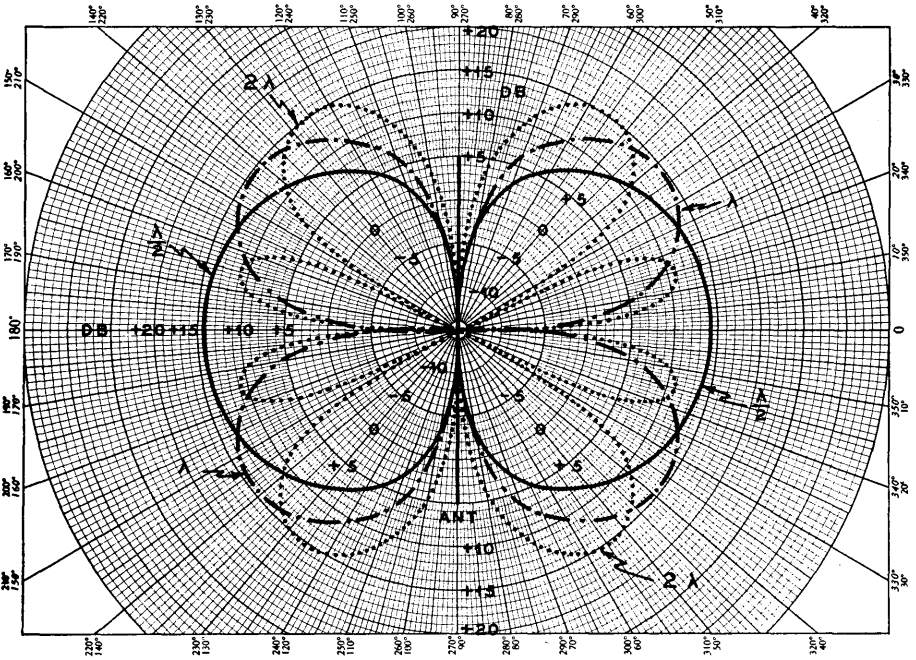

HORIZONTAL ANTENNAS IN FREE SPACE - FAR REMOVED FROM GROUND

— HALF WAVE ANT. - - - FULL WAVE ANT. ····· TWO WAVE ANT.

FIGURE 34. THEORETICAL FIELD STRENGTH IN DB UNITS OF THREE TYPES OF HORIZONTAL ANTENNAS IN FREE SPACE.

more than a few watts power is being used.

Directive antennas can be designed to give as high as 23 db gain over that of a single half-wave antenna. However, this high gain (nearly 200 times as much power) is confined to such a narrow beam that it can be used only for commercial applications in point-to-point communication.

The increase in radiated power in the desired direction is obtained with a corresponding loss in all other directions. Gains of 3 to 10 db seem to be of more practical value for amateur communication because the angle covered by the beam is wide enough to sweep a fairly large area. Three to 10 db means the equivalent of increasing power from 2 to 10 times.

For each of the amateur high-frequency bands, there is a certain optimum vertical angle of radiation. Energy radiated at an angle much higher than this optimum angle is largely lost, while radiation at angles much lower than this optimum angle oftentimes is not nearly so effective in producing signals at a distant station.

For this reason, the horizontal directivity pattern as measured on the ground is of no import when dealing with frequencies and distances dependent upon sky wave propagation. It is the horizontal directivity (or gain or discrimination) *measured at the most useful vertical angles of radiation* that is of consequence. The horizontal radiation pattern as measured on the ground is considerably different from the pattern obtained at a vertical angle of 15 degrees, and still more different from a pattern obtained at a vertical angle of 30 degrees. In general, a propagation angle of 30° above the horizon has proved to be the most effective for 40- and 80-meter operation over long distances. The energy which is radiated at angles other than approximately 30° above the earth is not very effective at these frequencies for dx.

For operation at higher frequencies (lower wavelengths), such as in the vicinity of 20 meters, the most effective angle of radiation is usually about 15° above the horizon, from *any* kind of an antenna. The most effective angles for 10-meter operation are those in the vicinity of 10°. These angles give best

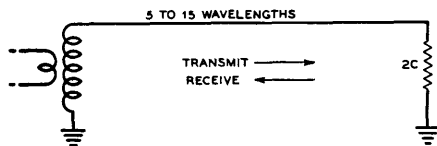

Figure 35. Aperiodic, unidirectional, long-wire antenna.

results for long-distance communication because the waves are most effectively reflected from the *Heaviside layer* for the various frequencies or wavelengths mentioned.

The fact that many simple arrays give considerably more gain at 10 and 20 meters than one would expect from consideration of the horizontal directivity can be explained by the fact that, besides providing some horizontal directivity, they concentrate the radiation at a lower *vertical* angle. The latter may actually account for the greater portion of the gain obtained by some simple 10-meter arrays. The gain that can be credited to the increased horizontal directivity is never more than 4 or 5 db at most with the simpler arrays. At 40 and 80 meters this effect is not so pronounced, most of the gain from an array resulting from the increased horizontal directivity. Thus, a certain type of array may provide 12 to 15 db effective gain over a dipole at 10 meters, and only 3 or 4 db gain at 40 meters.

The chart in figure 34 shows the theoretical field strength in db units of three types of horizontal antennas in free space. By free space is meant a height of many wavelengths above ground, a condition seldom found in practice. The solid-line curve shows the field strength in *db units* surrounding a half-wave horizontal antenna. Since this curve is plotted in db units, the two lobes are somewhat different in shape than those of most other radiation patterns. The maximum radiation is at right angles to the antenna wire.

Another group of lobes is represented by the dot-and-dash line; they represent the radiation pattern of a full-wave horizontal antenna. The maximum radiation takes place at an angle of about 54° from the direction of the antenna wire and is about one-half db greater than the power radiated at right angles

RADIATION RESISTANCE OF HARMONIC ANTENNAS

No. of λ	Radiation resistance ohms	Angle of maximum radiation	Power in major lobe of radiation
1	72	90°	1
2	90	55°	1.15
3	100	46.5°	1.25
4	110	37°	1.35
5	115	34.5°	1.5
6	122	30.5°	1.7
7	125	28°	1.85
8	131	27°	2.1
9	135	25.5°	2.3
10	139	24°	2.55
11	142	22.5°	2.75
12	145	21°	3.1
13	148	20.5°	3.3
14	150	20°	3.65
15	152	19.5°	3.9
16	154	19°	4.25
17	156	18.5°	4.55
18	158	18°	4.9
19	160	17.5°	5.25
20	162	17°	5.65
21	163.5	16.5°	6.0
22	165	16°	6.3
23	166.5	15.5°	6.75
24	168	15°	7.2

from a half-wave antenna, assuming the power input is the same. Similarly, an antenna operated with two full waves provides a gain in its optimum direction of somewhat more than 1 db over that of a half-wave antenna. It can be seen that a long-wave antenna, operated on its harmonics, does not provide very much gain in signal strength in the optimum direction of the field pattern. When the antenna is operated with two full waves, it has two minor lobes on each side of the wire; these lobes have a magnitude of approximately 4 db less than the major lobes. The curve of a

two-wave antenna is represented by the all-dotted lines.

The curves indicate the radiation in any plane, including the antenna wire in the case of antennas far removed from earth. The earth changes the magnitude of the lobes when the antenna is in the vicinity of the ground.

The presence of the ground near the antenna wire changes the directivity pattern at various heights above ground and also for various angles of radiation above the horizon.

Long-Wire Radiators

The accompanying tables give the pertinent characteristics of any long-wire radiator at a glance.

The directivity of a long wire does not increase very much as the length is increased beyond about 15 wavelengths. In fact, the directivity does not go up in proportion to the additional cost of the long wire after about 8 wavelengths are used. This is due to the fact that all long-wire antennas are adversely affected by the r.f. resistance of the wire. This resistance also affects the Q or selectivity of the long wire, and as the length is increased, the tuning of the antenna becomes quite broad. In fact, a long wire about 15 waves long is practically aperiodic and works almost equally well over a wide range of frequencies.

Terminating the far end of a long-wire antenna in its characteristics im-

LONG-ANTENNA DESIGN CHART

Length in Feet. End-Fed Antennas

Frequency in Mc.	1 λ	1½ λ	2 λ	2½ λ	3 λ	3½ λ	4 λ	4½ λ
30	32	48	65	81	97	104	130	146
29	33	50	67	84	101	118	135	152
28	34	52	69	87	104	122	140	157
14.4	66½	100	134	169	203	237	271	305
14.2	67½	102	137	171	206	240	275	310
14.0	68½	103½	139	174	209	244	279	314
7.3	136	206	276	346	416	486	555	625
7.15	136½	207	277	347	417	487	557	627
7.0	137	207½	277½	348	418	488	558	628
4.0	240	362	485	618	730	853	977	1100
3.9	246	372	498	625	750	877	1000	1130
3.8	252	381	511	640	770	900	1030	1160
3.7	259	392	525	658	790	923	1060	1190
3.6	266	403	540	676	812	950	1090	1220
3.5	274	414	555	696	835	977	1120	
2.0	480	725	972	1230	1475			
1.9	504	763	1020	1280				
1.8	532	805	1080					

pedance makes it even more aperiodic and, at the same time, tends to make it unidirectional. (See figure 35.) In other words, it radiates only away from the transmitter out over the terminating resistance. The power that otherwise would be radiated out back in the opposite direction from the resistance-terminated end is dissipated in the resistance. One of the most practical methods of feeding a long-wire antenna is to bring one end of it into the radio room for direct connection to a tuned antenna circuit which is link-coupled to the transmitter. The antenna can be tuned to exact resonance for operation on any harmonic by means of the tuned circuit which is connected to the end of the antenna. This tuned circuit corresponds to an adjustable, nonradiating half-wave section of the antenna. A ground is sometimes made to the center of the tuned coil.

When a long antenna is end-fed, its radiation pattern is modified in most cases because a portion of the antenna is bent down into the radio operating room. The bent portion will change the pattern to some extent because part of the radiation will be vertically polarized. Any of the usual forms of nonradiating r.f. feeder systems can be utilized without disturbing the horizontal directivity pattern. The antenna should *not be broken at any voltage loop* though the long-wire antenna can be opened and current-fed at a point of maximum current by means of a twisted-pair feeder or concentric line.

If opened at a voltage loop to accommodate a two-wire feeder or stub, the phasing will be disturbed. Hence, it is usually fed at one end when voltage-fed. This permits multiband operation if tuned feeders are used.

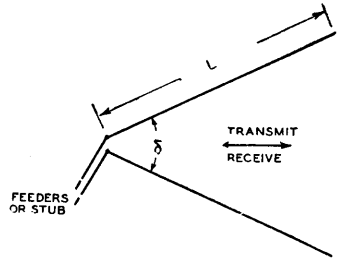

Figure 36. Typical V-beam antenna.

THE V ANTENNA

If two long-wire antennas are built in the form of a V, it is possible to make two of the maximum lobes of one leg shoot in the same direction as two of the maximum lobes of the other leg of the V. The antenna is bidirectional (two opposite directions) for the main lobes of radiation. Each side of the V can be made any odd or even multiple of quarter wavelengths, depending on the method of feeding the apex of the V. The complete system must be a multiple of half waves. If each leg is an even number of quarter waves long, the antenna must be voltage-fed; if an odd number of quarter waves long, current feed must be used.

By choosing the proper angle δ , figure 36, the lobes of radiation from the two long-wire antennas aid each other to form a bidirectional beam. Each wire by itself would have a radiation pattern similar to that shown for antennas operated on harmonics. The reaction of one upon the other removes two of the four main lobes and increases the other two in such a way as to form two lobes of greater magnitude.

V-ANTENNA DESIGN TABLE.

Frequency in Kilocycles	$L = \lambda$ $\delta = 104^\circ$	$L = 2\lambda$ $\delta = 75^\circ$	$L = 4\lambda$ $\delta = 52^\circ$	$L = 8\lambda$ $\delta = 39^\circ$
	28000	34' 8"	69' 8"	140'
28500	34' 1"	68' 6"	137' 6"	275'
29000	33' 6"	67' 3"	135'	271'
29500	33'	66' 2"	133'	266'
30000	32' 5"	65'	131'	262'
14050	69'	139'	279'	558'
14150	68' 6"	138'	277'	555'
14250	68' 2"	137'	275'	552'
14350	67' 7"	136'	273'	548'
7020	138' 2"	278'	558'	1120'
7100	136' 8"	275'	552'	1106'
7200	134' 10"	271'	545'	1090'
7280	133' 4"	268'	538'	1078'

The correct wire lengths and the degree of the angle δ are listed in the *V-Antenna Design Table* for various frequencies in the 10-, 20- and 40-meter amateur bands. These values must sometimes be reduced slightly if one of the wires is in the vicinity of some large object.

The legs of a long-wire V antenna are usually so arranged that the included angle is twice the angle of the major lobe from a single wire if used alone. This arrangement concentrates the radiation of each wire along the bisector of the angle and permits part of the other lobes to cancel each other. With legs shorter than three wavelengths, the best directivity and gain are obtained with a somewhat smaller angle than that determined by the lobes. P. S. Carter pointed out in I. R. E. *Proceedings* for June, 1932, that optimum directivity for a one-wave V is obtained when the angle is 90° rather than 108° as determined by the ground pattern alone.

If very long wires are used in the V,

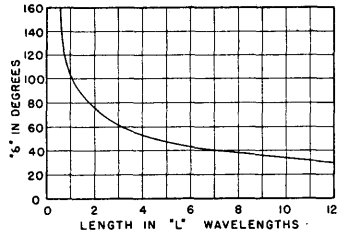

V-BEAM CURVE
Showing the included angle between the two legs of a V-beam antenna for various leg lengths. The included angle is sometimes made slightly less than that indicated by the curve, especially when the legs are short.

the angle between the wires is almost unchanged when the length of the wires in wavelengths is altered. However, an error of a few degrees causes a much larger loss in directivity and gain in the case of the longer V than in the shorter one which is broader.

The V antenna can have each leg either an even or an odd number of quarter waves long. If an even number of quarter waves long, the antenna must be voltage-fed at the apex of the V, while if an odd number of quarter waves long, current feed can be used.

The vertical angle at which the wave is best transmitted or received from a horizontal V antenna depends largely upon the included angle. The sides of the V antenna should be at least a half wavelength above ground; commercial practice dictates a height of approximately a full wavelength above ground.

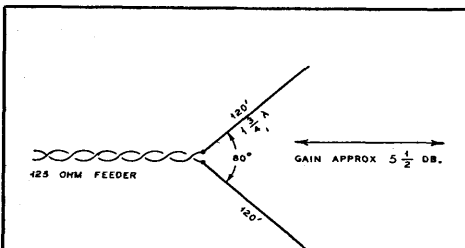

Figure 37. 20-meter V antenna, smallest worthwhile size.

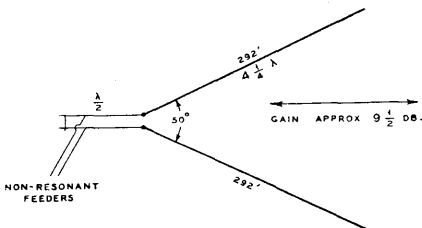

Figure 38. More directive V than shown above, with more efficient method of feed. Dimensions are for 20 meters.

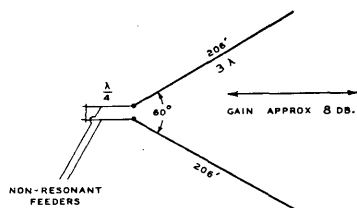

Figure 39. 20-meter V with moderate gain and directivity, best suited for general amateur use.

THE RHOMBIC ANTENNA

The terminated *rhombic* or *diamond* is probably the most effective directional antenna that is practical for amateur communication. This antenna is non-resonant, with the result that it can be used on three amateur bands, such as 10, 20 and 40 meters. When the antenna is nonresonant, i.e., properly terminated, the system is unidirectional and the wire dimensions are not at all critical. The rhombic antenna can be suspended over irregular terrain without greatly affecting its practical operation.

The *tuned diamond* antenna consists of two V antennas, end to end, and *without a free end termination*, as shown in figure 40. The antenna is *bidirectional*, in which case the lengths are very critical, and the system must be tuned to exact resonance with the operating frequency. It has less gain than a properly terminated rhombic of the same size.

If the free end is terminated with a resistance of a value from 700 to 800 ohms, as shown in figures 41, 42 and 43, the backwave is eliminated, the forward gain is increased and the antenna can be used on several bands without changes. The terminating resistance

should be capable of dissipating one-third the power output of the transmitter and should have very little reactance. A bank of lamps can be connected in series-parallel for this purpose or heavy-duty carbon-rod resistances can be used. The latter can be procured from the Carborundum Co. For medium- or low-power transmitters, the noninductive *plaque* resistors will serve as a satisfactory termination.

The terminating device should, for technical reasons, present a small amount of inductive reactance at the point of termination. However, this should not be too great. By using a bank of lamps in series-parallel, this qualification will be met. The total dissipation of the lamps will be roughly a third of the transmitter output.

Because of the high temperature coefficient of resistance for both carbon and Mazda lamps, neither type is any too satisfactory when used alone, especially in a keyed transmitter. However, by connecting both types in parallel, the resistance can be made fairly constant. This is because the coefficient of one type of lamp is positive, while that of the other is negative. The most constant combination will utilize a 110-volt carbon lamp of 2X watts across each 125-volt

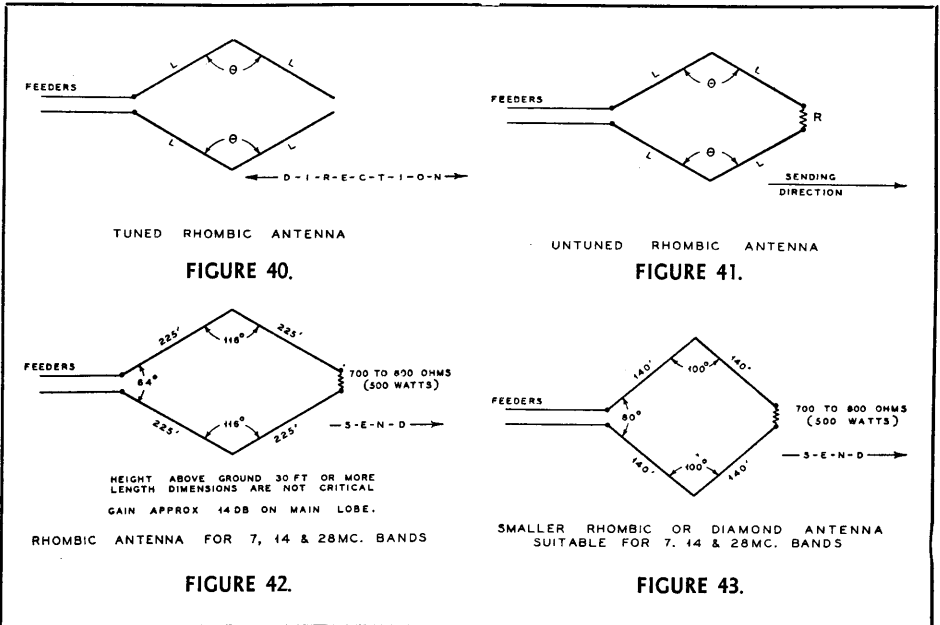

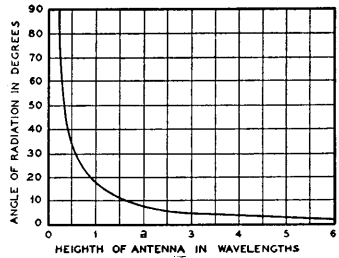
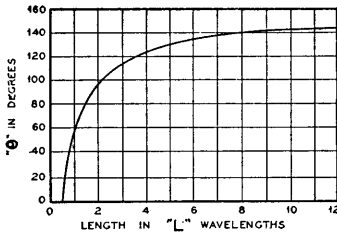
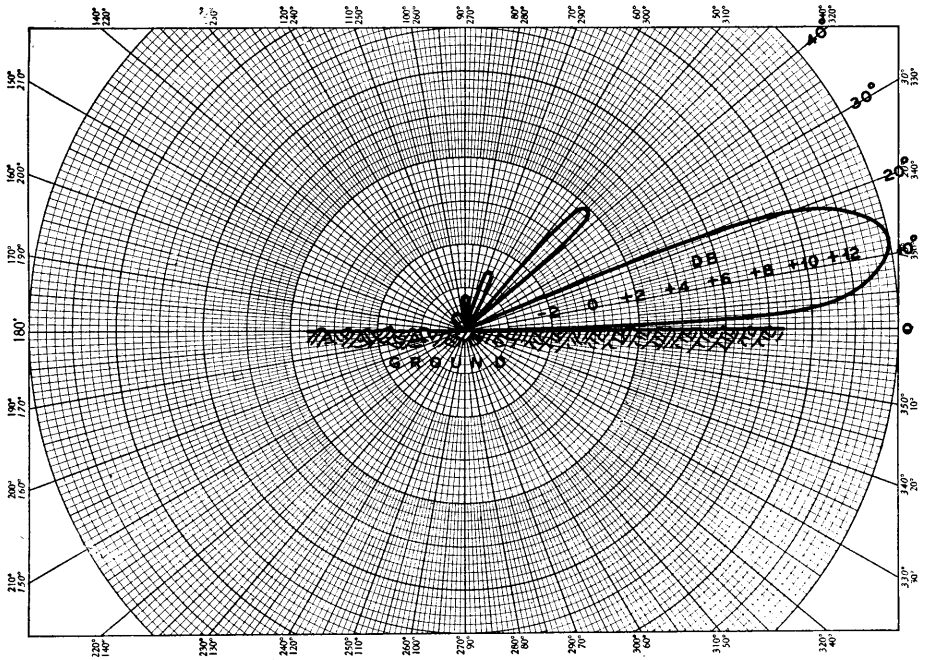

Figure 44 A and B. Diamond-antenna design chart.

Mazda lamp of X watts. Thus, a 60-watt Mazda lamp would have a 120-watt carbon lamp across it. The desired resistance can be obtained by series-connecting or series-paralleling several such units.

A compromise terminating device com-

monly used consists of a terminated 250-foot or longer length of line made of resistance wire which *does not have too much resistance per unit length*. If the latter qualification is not met, the reactance of the line will be excessive. A 250-foot line consisting of no. 25



VERTICAL DIRECTIVITY RHOMBIC ANTENNA

$L = 3\frac{1}{4} \lambda$ $\Theta = 58^\circ$ $H = \frac{\lambda}{2}$

14 DB. GAIN OVER VERTICAL HALF WAVE

FIGURE 45.

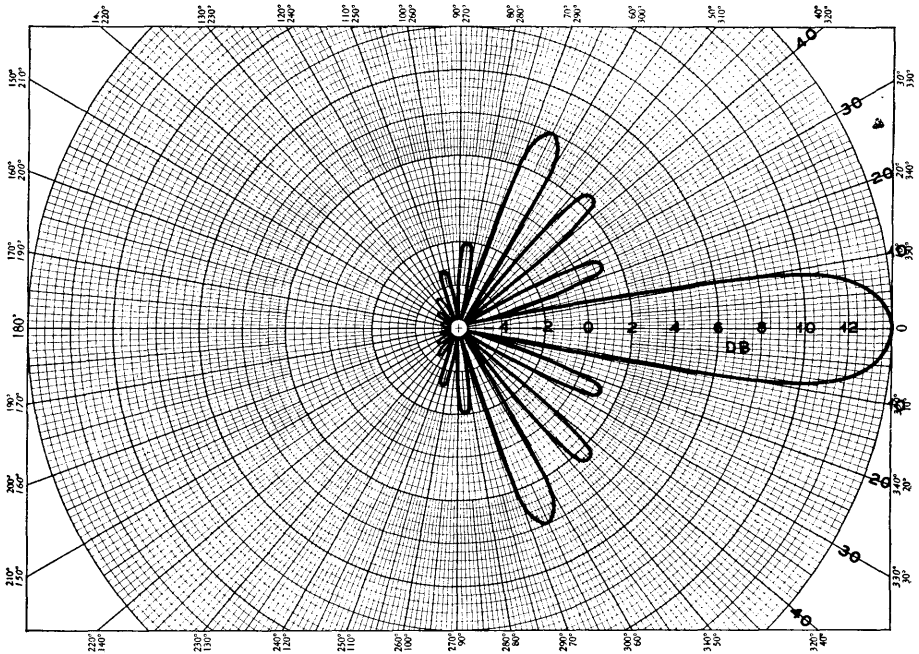

HORIZONTAL DIRECTIVITY — RHOMBIC ANTENNA
 $L = 3\frac{1}{4} \lambda$ $\Theta = 58^\circ$
 14 DB. GAIN OVER DIPOLE

FIGURE 46.

nichrome wire, spaced 6 inches and terminated with 800 ohms will serve satisfactorily. Because of the attenuation of the line, the lumped resistance at the end of the line need dissipate but a few watts even when high power is used. A half-dozen 5000-ohm 3-watt carbon resistors in parallel will serve for all except very high power. The attenuating line may be either coiled or folded back on itself to take up less room.

The input resistance of the diamond which is reflected into the transmission line that feeds it is always somewhat less than the terminating resistance, and is around 700 or 750 ohms when the resistor is 800 ohms.

The antenna should be fed with a nonresonant line, preferably with an impedance of approximately 700 ohms. The four corners of the diamond, when possible, should be at least a half wavelength above ground at the lowest fre-

quency of operation. For three-band operation, the proper angle θ for the center band should be observed.

The diamond antenna transmits a horizontally polarized wave at a low angle above the horizon in the case of a large antenna. The angle of radiation above the horizon goes down as the height above ground is increased.

The vertical directivity of a typical rhombic antenna suitable for amateur communication is shown in the polar diagram, figure 45. This antenna will give a gain of approximately 14 db over that of a vertical half-wave antenna. The horizontal directivity of the same antenna is shown in another polar diagram, figure 46. The smaller lobes of radiation prevent the antenna from being truly unidirectional; the amplitude, however, is relatively small in comparison to the main lobe of radiation. The sides of this diamond antenna are

$3\frac{1}{4}$ wavelengths long, with the angle θ equal to 58 degrees. The correct angle θ for any length L of the wires in each leg is shown in figure 44.

The height above ground is a half wave and the vertical angle of radiation becomes approximately 13 degrees. This antenna will work over a range of four to one in frequency although the directivity is greatest at the frequency for which the dimensions are as given above.

Thus, for operation on 7, 14 and 28 megacycles with a peak at 14 megacycles, the dimensions are: length of each leg, 218 to 225 feet; height above ground, 33 feet, and the angles those given above.

Should the height be raised to 66 feet above ground, the directivity remains about the same, but the angle of vertical radiation goes down to about 9 degrees above the horizon on 14 Mc. This amount of gain is truly remarkable for such a simple antenna, and, as the diamond requires no critical adjustment for good results, its use is highly recommended for those who have the necessary room available.

The diamond antenna should not be tilted in any plane. In other words, the poles should be the same height and the plane of the antenna should be parallel with the ground. Tilting the antenna simply sacrifices about half the directivity due to the fact that the reflection from the ground does not combine with the incident wave in the desired phase

unless the antenna is parallel with the ground.

The diamond loses a good deal of directivity when the terminating resistor is left off and it is operated as a resonant antenna. If it is desired to reverse the direction of maximum radiation, it is much better practice to run feeders to both ends of the antenna and mount terminating resistors also at both ends. Then, with either mechanically- or electrically-controlled, remote-controlled double-pole double-throw switches located at each end of the antenna, it becomes possible to reverse the array quickly for transmission or reception to or from the opposite direction.

The directive gain of the diamond or Bruce rhombic antenna is dependent on the height above ground and the side angle as well as the overall length of each of the four radiating wires in the array. Therefore, the gain is not easy to calculate.

STACKED DIPOLE ANTENNAS

The characteristics of a half-wave dipole have already been described. When another dipole is placed in the vicinity and excited either directly or parasitically, the resultant radiation pattern will depend upon the spacing and phase differential as well as the relative magnitude of the currents. With spacings less than 0.625 wavelength, the radiation is mainly broadside to the two wires (bidirectional) when there is no phase difference, and *through* the wires (end fire) when the wires are 180 degrees out of phase. (See figures 48 and 49). With phase differences between 0 and 180 degrees (45, 90 and 135 degrees for instance), the pattern is somewhat unsymmetrical, the radiation being *greater in one direction* than in the opposite direction. In fact, with certain critical spacings the radiation will be practically unidirectional for phase differences of 45, 90 and 135 degrees.

With spacings of more than 0.625 wavelength, more than two main lobes appear for all phasing combinations; hence, such spacings are seldom used.

With the dipoles driven so as to be *inphase*, the most practicable spacing is between 0.5 and 0.625 wavelength. The latter provides greater gain, but two minor lobes are present which do not

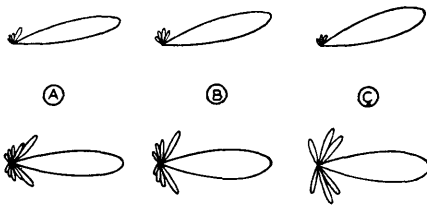

Figure 47. Radiation patterns of three rhombic antennas: vertical directivity above and horizontal directivity below. A, pattern of rhombic antenna 4 waves on a side and one wavelength high. B, 3 waves on a side and $\frac{3}{4}$ wavelength high. C, 2 waves on a side and a half wavelength high. The above conditions also hold for a single antenna worked over a frequency range of 2/1.

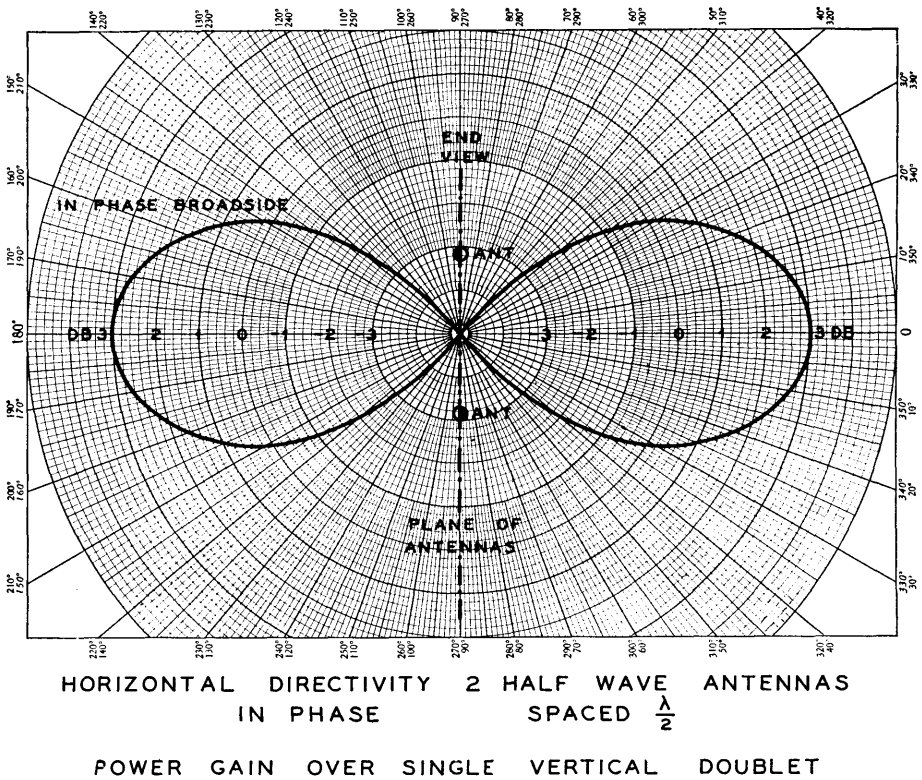

FIGURE 48.

appear at 0.5-wavelength spacing. The radiation is broadside and the gain is slightly greater than can be obtained from two dipoles out of phase. The gain falls off rapidly for spacings less than 0.375 wavelength, and there is little point in using spacing of 0.25 wavelength or less with inphase dipoles.

When the dipoles are fed 180 degrees out of phase, the directivity is greatest with close spacing though there is but little difference in the pattern after the spacing is made less than 0.125 wavelength. However, the radiation resistance becomes so low for spacings of less than 0.1 wavelength that such spacings are not practicable for antenna arrays.

The best unidirectional pattern is obtained with 0.1- or 0.125-wavelength spacing and 135-degree phase lag. As it is rather difficult to get other than 0- and 180-degree phasing in driven radiators, parasitic directors and reflectors are usually resorted to for odd values of

phasing. These are driven parasitically rather than directly by feeders, and the phasing can be varied by altering the length of the parasitic elements.

In the three foregoing examples, most of the directivity provided is in a plane at a right angle to the two wires though, when out of phase, the directivity is in a line *through* the wires and, when in-phase, the directivity is *broadside* to them. Thus, if the wires are oriented vertically, mostly horizontal directivity will be provided. If the wires are oriented horizontally, most of the directivity obtained will be *vertical* directivity.

To increase the sharpness of the directivity in all planes that include one of the wires, additional identical elements are added *in the line of the wires* and fed so as to be *inphase*. The familiar H array is one array utilizing both types of directivity in the manner prescribed. The two-section W8JK flat-top beam is another.

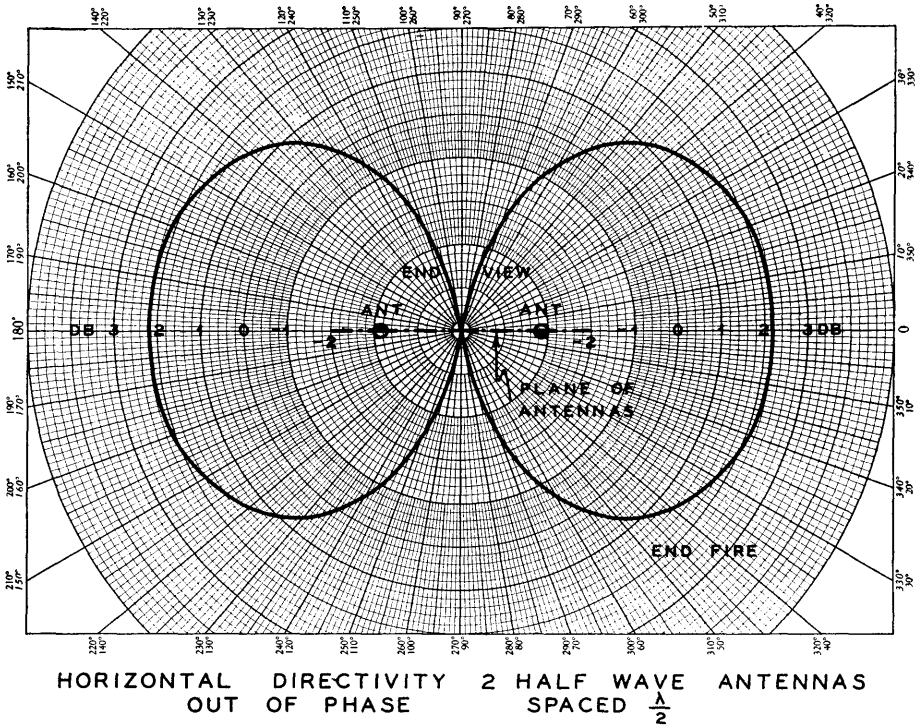

POWER GAIN OVER SINGLE VERTICAL DOUBLET
FIGURE 49.

These two antennas in their various forms are directional in a horizontal plane in addition to being low-angle radiators, and are perhaps the most practicable of the bidirectional stacked-dipole arrays for amateur use. More phased elements can be used to provide greater directivity in planes including one of the radiating elements. The H then becomes a barrage or Sterba array.

For unidirectional work, the most practicable stacked dipole arrays for amateurs are those using close-spaced directors and reflectors. The close spacing (0.1 to 0.125 wavelength) is little more directive than quarter-wave spacing and has the minor disadvantage of lower radiation resistance, but a more compact array is obtained, the latter being an important item if the array is to be rotated. See pages 115 and 118.

While there is almost an infinite variety of combinations when it comes to obtaining directivity by means of stacked dipoles, only those systems which are

most practical from an amateur standpoint will be discussed at length.

COLINEAR ANTENNAS

Franklin or *colinear* antennas are widely used by amateurs. The radiation is bidirectional broadside to the antenna. The antenna consists of two or more half-wave radiating sections with the current *inphase* in each section. This is accomplished by quarter-wave stubs between each radiating section or by means of a tuned coil and condenser or resonant loading coil between each half-wave radiating section. The quarter-wave stub is a folded half-wave wire in which the wires are sufficiently together so that the radiation is neutralized.

Two half waves *inphase* will give a gain of approximately 2.5 db with respect to a single half-wave antenna; three sections will give a gain of approximately 4 db. Additional half-wave sections increase this power gain ap-

proximately one db per section.

Various feeder systems are shown in the accompanying sketches. A tuned feeder can be used in place of a quarter-wave stub and 600-ohm line. The latter will allow a two-section *colinear* antenna to be operated as a single section half-wave antenna (current-fed doublet) on the next longer amateur wave band. For example, an antenna of this type would be a half-wave antenna on 40 meters and a two-section *colinear* antenna on 20 meters. The direction of current at a given instant and the location of the current loops are indicated in the sketches by means of arrowheads and dots, respectively.

Practically all directivity provided by colinear sections is in a horizontal plane. The effect on the vertical directivity is negligible when additional sections are provided. For this reason, the Franklin array is useful particularly on the 40-, 80- and 160-meter bands, where low-angle radiation is not so important. On the higher frequency bands, 20 and 10 meters, an array providing *vertical directivity in addition to horizontal directivity is desirable*. Hence, the Franklin antenna is not as suited for use on the latter two bands as are some of the arrays to be described.

As additional colinear elements are added to a doublet, the radiation resistance goes up much faster than when

COLINEAR-ANTENNA DESIGN CHART

BAND	FRE-QUENCY IN MC.	L ₁	L ₂	L ₃
10 METERS	30	16'	16' 5"	8' 2"
	29	16' 6"	17'	8' 6"
	28	17' 1"	17' 7"	8' 9"
20 METERS	14.4	33' 4"	34' 3"	17' 1"
	14.2	33' 8"	34' 7"	17' 3"
	14.0	34' 1"	35'	17' 6"
40 METERS	7.3	65' 10"	67' 6"	33' 9"
	7.15	67'	68' 8"	34' 4"
	7.0	68' 5"	70' 2"	35' 1"
75 METERS	4.0	120'	123'	61' 6"
	3.9	123'	126'	63'
	3.6	133'	136' 5"	68' 2"

additional half waves are added out of phase (harmonic operated antenna).

It should be borne in mind that the *gain* from a Franklin antenna depends upon the *sharpness* of the horizontal directivity. An array with several colinear elements will give considerable gain but will cover only a very limited arc.

MULTIPLE-STACKED BROADSIDE ARRAYS

Colinear elements may be stacked above or below another similar string of elements, thus providing vertical directivity. Two horizontal colinear elements stacked two above the other and separated by a half wavelength form the popular lazy H array, the upper illustration in figure 51. This is a highly effective array for high-frequency use

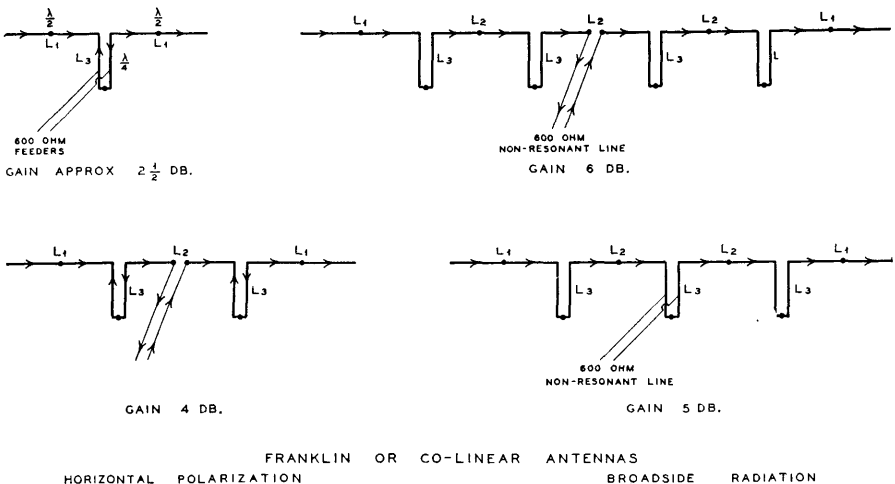
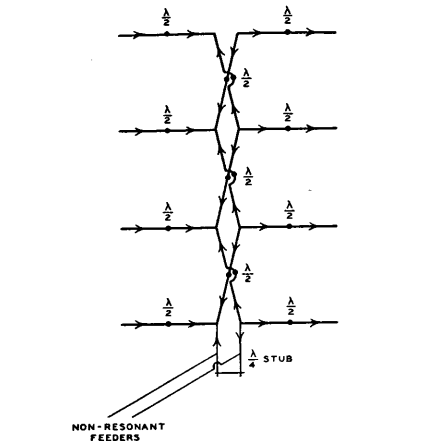
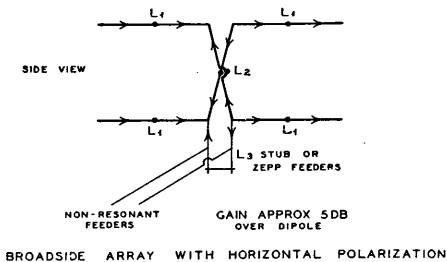

FIGURE 50.

STACKED-DIPOLE DESIGN TABLE

BAND	FREQUENCY IN MC.	L ₁	L ₂	L ₃
1.25 METERS	240	24"	24 1/2"	12"
	232	25"	25 1/2"	12 1/2"
	224	26"	26 1/2"	13"
2.5 METERS	120	4'	4' 1"	24"
	116	4' 1 1/2"	4' 3"	25"
	112	4' 3 1/2"	4' 5"	26"
5 METERS	60	8'	8' 2"	4' 1"
	58	8' 3"	8' 6"	4' 3"
	56	8' 7"	8' 9"	4' 5"
10 METERS	30	16'	16' 5"	8' 2"
	29	16' 6"	17'	8' 6"
	28	17' 7"	17' 7"	8' 9"
20 METERS	14.4	33' 4"	34' 2"	17'
	14.2	33' 8"	34' 7"	17' 3"
	14	34' 1"	35'	17' 6"
40 METERS	7.3	65' 10"	67' 6"	33' 9"
	7.0	68' 2"	70'	35'



HORIZONTALLY POLARIZED BROADSIDE ARRAY SECTION

Figure 51. Radiators are L₁, phasing stubs L₂ (refer to stacked-dipole design table).

vertical directivity considerably and producing very low-angle radiation for 28 Mc.

Vertical stacking may be applied to strings of colinear elements longer than two half waves. In such arrays the end quarter wave of each string of radiators is usually bent in to meet a similar bent quarter wave from the opposite end radiator. This provides better balance and better coupling between the upper and lower elements when the array is current-fed. Arrays of this type are shown in figure 52, and are commonly known as Sterba or barrage arrays.

Correct length for the elements and stubs can be determined for any stacked dipole from the *Stacked-Dipole Design Table*.

The stacked arrays of figures 51 and 52 are horizontally polarized. This is an

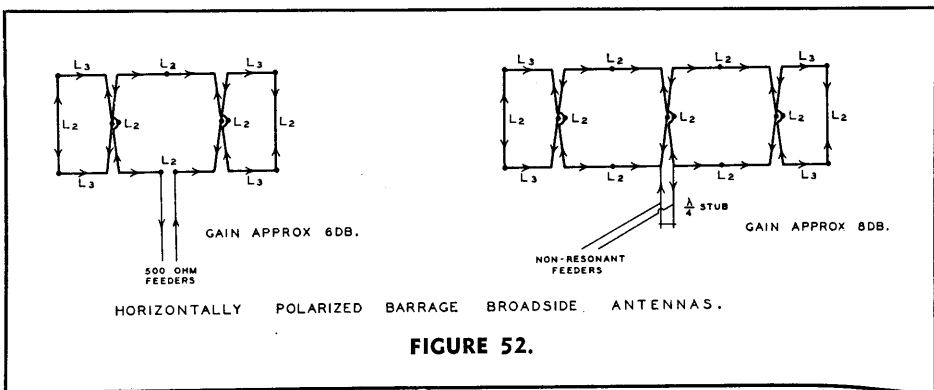

FIGURE 52.

without being too sharp, and is recommended for amateur work on 10 and 20 meters when moderate gain without too much directivity is desired.

More elements may be stacked as in the lower illustration, increasing the

BRUCE-ANTENNA DESIGN CHART

BAND	FREQUENCY IN MC.	L ₁	L ₃
2.5 METERS	120	12"	24"
	116	12½"	25"
	112	13½"	26"
5 METERS	60	2'	4' 1"
	58	2' 1"	4' 3"
	56	2' 2"	4' 5"
10 METERS	30	4'	8' 2"
	29	4' 1½"	8' 6"
	28	4' 3½"	8' 9"
20 METERS	14.4	8' 4"	17'
	14.2	8' 5"	17' 3"
	14.0	8' 6"	17' 6"

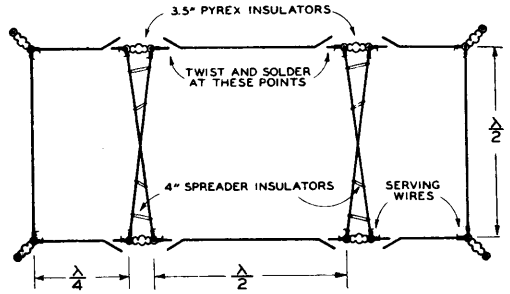

Figure 53. Practical method of construction of barrage arrays.

advantage when the antennas are used for reception as it will minimize ignition and other such noise. Over poor soil, the horizontal polarization is somewhat of an advantage also when transmitting.

In these sketches the arrowheads represent the direction of flow of current at a given instant; the dots represent the points of maximum current and lowest impedance. All arrows should point in the same direction in each portion of the radiating sections of the antenna in order to provide a field inphase for broadside radiation.

If the arrays just described are rotated through 90 degrees so that the radiators are vertical, the arrays will be vertically polarized. Such arrays are illustrated in figure 54. These arrays are used principally on 56 Mc. and higher

frequencies for quasi-optical work (surface-wave propagation).

THE BRUCE ANTENNA

The Bruce antenna consists of quarter- and eighth-wave sections, fed in such a manner that the current in adjacent vertical sections is inphase. The radiation is vertically polarized and broadside to the antenna. The current in the horizontal portions is out of phase as illustrated in figure 55. Very little radiation takes place from the horizontal portions of the antenna.

Good horizontal directivity will be obtained if the overall length is at least five wavelengths. A similar bent wire,

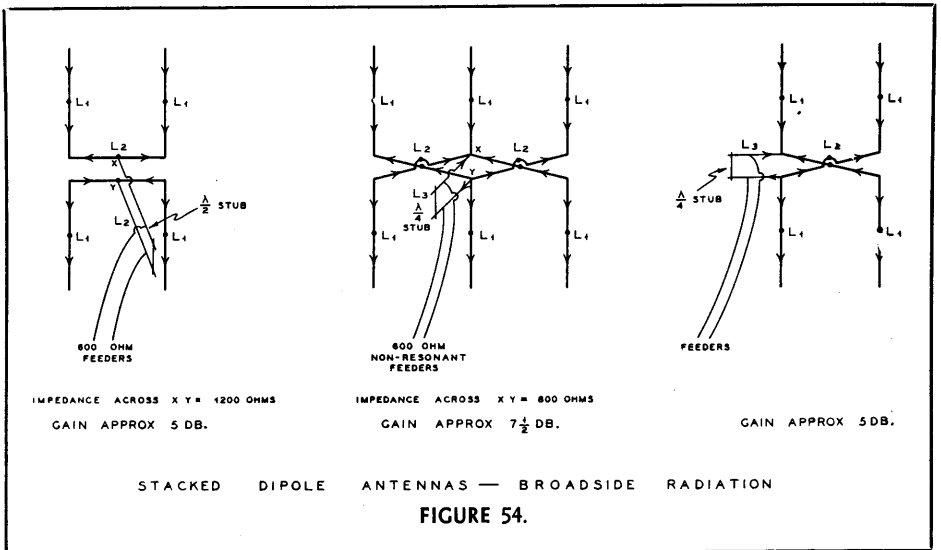

FIGURE 54.

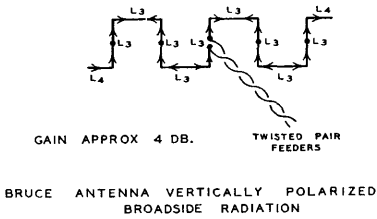

FIGURE 55.

placed a quarter wave behind the antenna, will act as a reflector and make the system unidirectional. The L_3 and L_4 sections of a Bruce antenna, in actual practice, are a continuous wire which can be mounted in a vertical plane by the use of insulators and additional sections of wire connected across the open-U-shaped portions of the bent wire.

The two forms of the Bruce antenna suitable for amateur communication are shown in figures 55 and 56. A *Design Chart* is given for wire lengths for the 2.5-, 5-, 10- and 20-meter amateur bands.

END-FIRE DIRECTIVITY

By placing an exactly similar array either in front or in back of either a half-wave dipole or a colinear array at a distance of from 0.1 to 0.25 wavelength and driving the two 180 degrees out of phase, directivity is obtained in a plane at *right angles* to the radiators. The radiation is maximum in this plane in a line drawn *through the two wires*. Hence, this type of bidirectional array is called *end fire*. A better idea of end-fire directivity can be obtained by referring back to figure 49.

Two similar groups of colinear elements spaced 0.125 wavelength and oriented horizontally will be directional broadside to the direction of the array as a whole. In spite of this, the array is considered end fire because maximum radiation is in the plane formed by the two wires even if the radiation is greatest at right angles to the array. This is rather confusing, but one has only to remember that end fire refers to the radiation with *respect to the two wires* in the array, rather than with respect to the array as a whole.

The vertical directivity of an endfire

bidirectional array which is oriented horizontally can be increased considerably by placing a similar end-fire array a half wave below it and excited in the same phase. Such an array is a combination broadside and end-fire affair. However, most arrays are made either broadside or end fire rather than a combination of both, though the latter type are quite satisfactory if designed properly.

KRAUS FLAT-TOP BEAM

A very effective bidirectional end-fire array is the Kraus *Flat-Top Beam*. Essentially, this antenna consists of two close-spaced dipoles or colinear arrays.

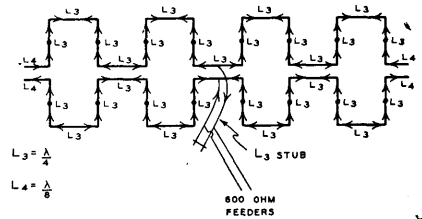

MODIFIED BRUCE ANTENNA WITH VERY EFFICIENT FEEDER SYSTEM AND DOUBLE ROW OF BRUCE ELEMENTS.

GAIN APPROX 9 DB.

FIGURE 56.

Because of the close spacing, it is possible to obtain the proper phase relationships in multisection flat tops by crossing the wires at the voltage loops rather than by resorting to phasing stubs. This greatly simplifies the array. (See figure 57.) Any number of sections may be used though the two-section arrangement is the most popular. Little extra gain is obtained by using more than four sections, and trouble from phase shift may appear.

A center-fed single-section flat-top beam cut according to the table can be used quite successfully on its second harmonic, the pattern being similar except that it is a little sharper. The single-section array can also be used on its fourth harmonic with some success though there will then be four cloverleaf lobes, much the same as with a full-wave antenna.

If a flat-top beam is to be used on more than one band, it is necessary to use tuned feeders.

The radiation resistance of a flat-top beam is rather low, especially when only one section is used. This means that the voltage will be quite high at the voltage loops. For this reason, especially good insulators should be used for best results in wet weather.

The exact lengths for the radiating elements are not especially critical because slight deviations from the correct lengths can be compensated for in the stub or tuned feeders. Proper stub adjustment is covered on page 83. Suitable radiator lengths and approximate stub dimensions are given in the accompanying design table.

Figure 57 shows top views of eight types of flat-top beam antennas. The dimensions for using these antennas on different bands are given in the design table. The 7- and 28-Mc. bands are divided into two parts, but the dimensions for either the low- or high-frequency ends of these bands will be

satisfactory for use over the entire band. In any case, the antennas are tuned to the frequency used by adjusting the shorting wire on the stub or tuning the feeders if no stub is used. The data in the table may be extended to other bands or frequencies by applying the proper factor. Thus, for 56- to 58-Mc. operation, the values for 28 to 29 Mc. are divided by two.

All of the antennas have a bidirectional horizontal pattern on their fundamental frequency. The maximum signal is broadside to the flat top. The single-section type has this pattern on both its fundamental frequency and second harmonic. The other types have four main lobes of radiation on the second and higher harmonics. The nominal gains of the different types over a half-wave comparison antenna are as follows: Single-section, 4 db; 2-section, 6 db; 3-section, 7 db; 4-section, 8 db.

The current directions on the antennas at any given instant are shown by the arrows on the wires in the figure. The voltage maximum points, where the cur-

FIGURE 57. TOP VIEWS OF EIGHT VARIETIES OF FLAT-TOP BEAMS, SHOWING BOTH CENTER- AND END-FED TYPES.

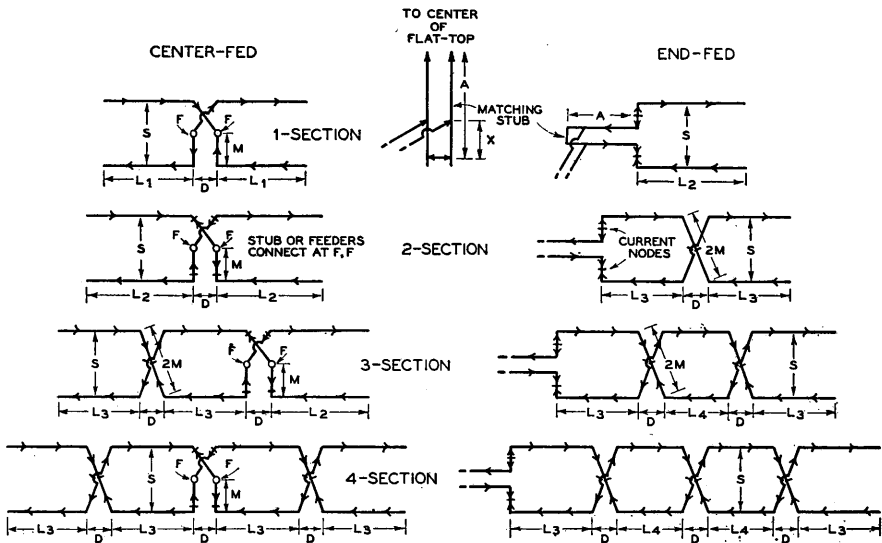

Dimensions for these antennas are given in the table; the symbols used are explained in the note accompanying the table.

rent reverses phase, are indicated by small X's on the wires.

Although the center-fed type of flat top is generally to be preferred because of its symmetry, the end-fed type is often convenient or desirable. For example, when a flat-top beam is used vertically, feeding from the lower end is in most cases more convenient.

If a multisection flat top array is end-fed instead of center-fed and tuned feeders are used, stations off the ends of the array can be worked by tying the feeders together and working the whole

affair, feeders and all, as a long-wire harmonic antenna. A single-pole double-throw switch can be used for changing the feeders and directivity.

BI-SQUARE BEAM

Four dipoles can be formed into the shape of a square as in figure 58A to produce a broadside radiator that has characteristics similar to the lazy-H stacked colinear array except for slightly less directivity and radiation resistance.

FLAT-TOP BEAM DESIGN TABLE

FRE- QUENCY	Spacing	S	L ₁	L ₂	L ₃	L ₄	M	D	A (¼) ap- prox.	A (½) ap- prox.	A (¾) ap- prox.	X ap- prox.
7.0-7.2 Mc.	$\lambda/8$	17'4"	30'	60'	52'8"	44'	8'10"	4'	26'	64'	96'	4'
7.2-7.3	$\lambda/8$	17'0"	29'6"	59'	51'8"	43'1"	8'8"	4'	26'	63'	94'	4'
14.0-14.4	$\lambda/8$	8'8"	15'	30'	26'4"	22'	4'5"	2'	13'	32'	48'	2'
14.0-14.4	.15 λ	10'5"	15'	30'	25'3"	20'	5'4"	2'	12'	31'	47'	2'
14.0-14.4	.20 λ	13'11"	15'	30'	22'10"	7'2"	2'	10'	29'	45'	3'
14.0-14.4	$\lambda/4$	17'4"	15'	30'	20'8"	8'10"	2'	8'	27'	43'	4'
28.0-29.0	.15 λ	5'2"	7'6"	15'	12'7"	10'	2'8"	1'6"	7'	16'	24'	1'
28.0-29.0	$\lambda/4$	8'8"	7'6"	15'	10'4"	4'5"	1'6"	5'	14'	22'	2'
29.0-30.0	.15 λ	5'0"	7'3"	14'6"	12'2"	9'8"	2'7"	1'6"	7'	16'	23'	1'
29.0-30.0	$\lambda/4$	8'4"	7'3"	14'6"	10'0"	4'4"	1'6"	5'	14'	21'	2'

Dimension chart for flat-top beam antennas. The meanings of the symbols are as follows:

L₁, L₂, L₃ and L₄: the lengths of the sides of the flat-top sections as shown in figure 57. L₁ is length of the sides of single-section center-fed; L₂, single-section end-fed and 2-section center-fed; L₃, 4-section center-fed and end-sections of 4-section end-fed, and L₄, middle sections of 4-section end-fed.

S: the spacing between the flat-top wires.

M: the wire length from the outside to the center of each crossover.

D: the spacing lengthwise between sections.

A (¼): the approximate length for a quarter-wave stub.

A (½): the approximate length for a half-wave stub.

A (¾): the approximate length for a three-quarter wave stub.

X: the approximate distance above the shorting wire of the stub for the connection of a 600-ohm line. This distance, as given in the table, is approximately correct only for 2-

section flat tops.

For single-section types it will be smaller and for 3- and 4-section types will be larger.

The lengths given for a half-wave stub are applicable only to single-section center-fed flat tops. To be certain of sufficient stub length, it is advisable to make the stub a foot or so longer than shown in the table, especially with the end-fed types. The lengths, A, are measured from the point where the stub connects to the flat top.

Both the center- and end-fed types may be used horizontally. However, where a vertical antenna is desired, the flat tops can be turned on end. In this case, the end-fed types may be more convenient, feeding from the lower end.

The approximate gains of the different types over a half-wave comparison antenna are as follows: Single-section, 4 db; 2-section, 6 db; 3-section, 7 db, and 4-section, 8 db. These correspond to power gains of about 2.5, 4, 5 and 7 respectively.

The gain and discrimination of the arrangement at A can be increased by mounting two similar radiating elements an eighth wave apart as in figure 58B. The radiation resistance is reduced considerably and the array is, therefore, more critical as to frequency than a single element which tunes rather broadly because of the relatively high radiation resistance. The close-spaced arrangement is preferable where it is desired to put a signal into one particular locality or two localities in opposite directions.

The close-spaced version illustrated at B is supported from a pole as high as possible by means of a T crossarm atop the pole and another at the bottom of the radiators. The crossarms will be about $4\frac{1}{2}$ feet for 10 meters or about 9 feet for 20 meters. The guy wires that hold the radiating elements out in the form of two squares also help support the pole.

Better insulation is required for the close-spaced version than is required for the arrangement illustrated at A. The lower radiation resistance of the close-spaced version results in considerably higher voltage at the voltage loops.

Approximate stub lengths are given in the diagram in terms of wavelength. These can be converted to feet by referring to the table on page 87. Exact adjustment of the shorting bar and position of the feeder attachment to the stub can be obtained by following the general procedure given for adjustment of shorted stubs, page 83. A crystal that hits the center of the band should be used during the stub adjustment procedure. Exact length of the radiator elements is not particularly critical because proper adjustment of the shorting bar will compensate for small errors in radiator length.

Both single- and close-spaced arrangements are horizontally polarized and bidirectional, maximum radiation occurring at *right angles* to the plane of the radiator square or squares.

UNIDIRECTIONAL ARRAYS

If the phasing of two dipoles or co-linear arrays is not exactly 0 or 180 degrees, the pattern becomes unsymmetrical. For certain phasing and spacings, a very good unidirectional pattern is obtained. The required odd

values of phasing can be obtained by cutting a parasitically driven element so as to present just the right amount of reactance. Whether the parasitic element acts as a director or reflector depends upon whether the reactance is inductive or capacitive. A parasitic reflector is made just a little longer than an electrical half wavelength, and a director a little shorter than an electrical half wave.

The presence of one or more parasitic elements affects the driven element itself, introducing some reactance so that slight compensation in the physical length is necessary for resonance. The presence of parasitic elements also reduces the radiation resistance; the more elements, the lower the radiation resistance. Reducing the spacing between the driven dipole and parasitic elements further reduces the radiation resistance.

The older data by Yagi on the parasitically operated director-reflector array called for quarter-wave spacing for the back reflector, half-wave spacing for side reflectors if any and three-eighths-wave spacing for directors. Subsequent work by Brown indicates the desirability of considerably closer spacing for both directors and the back reflector. Spacings of 0.1 to 0.125 wavelength are highly satisfactory for either a director or reflector.

The phasing adjustment (length of parasitic elements) is quite critical with respect to frequency, and can best be accomplished by cut-and-try and the help

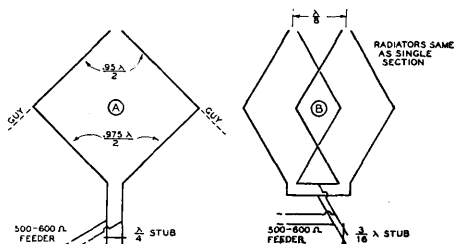

Figure 58. The fundamental bi-square beam element is shown at A. The close-spaced version at B provides greater gain and directivity. Either arrangement may be supported from a single pole, the B arrangement requiring a pair of T cross-arms.

of a field strength meter. This is especially true when more than one parasitic element is utilized. It will be found that the adjustment which gives the best forward gain is not the same as that which gives best front to back discrimination though they are approximately the same.

If only one parasitic element is used, the nose of the directivity pattern will be quite broad though the front-to-back radiation ratio will be quite high. The pattern resembles a valentine heart except that the tip is rounded instead of pointed. If the phasing is adjusted for maximum forward gain rather than maximum discrimination, a small lobe in the backward direction will appear and the nose of the main lobe will be slightly sharper.

The foregoing applies to the horizontal directivity when the driven and parasitic dipoles are *vertical*. When the dipoles are orientated *horizontally*, as in most amateur applications for wavelengths above 5 meters, the pattern is somewhat different, the horizontal directivity depending upon the vertical angle of radiation. The horizontal directivity is greatest for low vertical angles of radiation when the dipoles are oriented horizontally. For this reason, such an array will exhibit greater discrimination on 10 meters than on 40 meters, for instance.

A close-spaced parasitic director or reflector will lower the radiation resistance of the driven element. If two parasitic elements are used, the radiation resistance will be lowered still more. Consequently, the voltage at the ends of the dipoles of such an array is high and good insulation is essential, not only because of loss but because the phasing will be affected by wet weather if poor insulators are used at the high voltage points. Self-supporting quarter-wave rods permit construction of 10- and 20-meter arrays of this type without the need for insulators.

The low radiation resistance makes the problem of current (center) feed quite difficult. Twisted pair or concentric line cannot be used without incorporating a matching transformer. A linear transformer of tubing (Q section) cannot be practically designed to have a low enough surge impedance to match a 600-ohm line. A simple feed method that is satisfactory is a delta-matched open-wire line of from

400 to 600 ohms. The feeder should be fanned out and attached a short distance each side of the center of the driven dipole. The feeders should be slid back and forth equidistant from the center until standing waves on the line are at a minimum.

A horizontal driven dipole and close-spaced director or reflector are commonly used as a rotatable array on 10 and 20 meters; such an arrangement is discussed at length later in this chapter.

REINARTZ COMPACT BEAM ANTENNA

A compact directive antenna, conceived by John L. Reinartz, is shown in figure 59. It is suitable for 5- and 10-meter transmission and reception, and its field pattern shape is roughly similar to that of a half-wave vertical antenna with single reflector.

A 5-meter antenna consists of two 8-foot lengths of tubing, bent into a circle, with 2-inch to 3-inch spacing between the tubes. The circles are not closed; an opening of one inch remains as shown in the diagram.

The loop can be placed in either a horizontal or vertical plane, depending upon whether horizontal or vertical polarization is desired. The actual power gain over that of a vertical half-wave antenna in the desired direction is only 18 per cent, but the power directivity is nearly 6-to-1.

Two 16½-foot rods can be used for 10-meter operation, 33-foot rods for 20 meters. The spacing between the rods, or circles, need not be increased when the antenna is built for operation on the longer wavelengths.

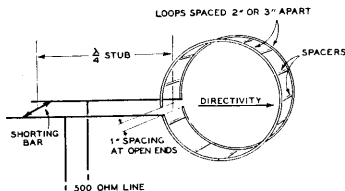

Figure 59. Reinartz compact beam antenna with spaced feeder and stub.

The antenna is useful because of its *discrimination* (front-to-back ratio) rather than for the small power gain it provides.

As the null is rather sharp, the antenna is useful for direction finding when arranged for rotation. It will give not only the line of the transmitting station, but the *direction* when rotated for *minimum* signal. If the array is to be used only for receiving, some loss in the transmission line can be tolerated and a twisted-pair line can be used by attaching it to the end of the matching stub in place of the shorting bar.

The antenna will work much the same if a single-turn loop is used instead of the parallel conductors illustrated.

ORIENTATION OF BEAM ANTENNAS

Directive antennas, especially those sharp enough to give a large effective power gain, should be so oriented that the line or lines of maximum radiation fall in the desired direction or directions.

The direction of *true north* must be known with reasonable accuracy. This may vary in the United States by as much as 20 degrees from magnetic north as indicated by a compass.

The magnetic declination (variation of

magnetic north in degrees east or west of true north) for your locality can be obtained by referring to a map compiled by the U.S. Coast and Geodetic Survey and available from the Superintendent of Documents, Washington, D. C. The number of the map is 3077 and it is sent only on receipt of 20 cents in coin.

A simpler method of determining your declination is to inquire of your city engineers or any surveyor or civil engineer in your locality. Any amateur astronomer can also help you to determine the direction of true north.

The next problem is to determine the *great circle* direction of the country at which you wish to aim your beam, as this is the path taken by radio signals to a distant point. This can be done with great accuracy by means of spherical trigonometry, but the method is rather involved and requires a set of tables and considerable calculation. A simpler method is to stretch a thread from the corresponding two points on a large globe of the world (not a cheap one—they are often inaccurate).

Great circle maps, as given in the *RADIO Antenna Handbook*, can also be used to determine the direction in which a beam antenna should be aimed to hit a certain area or spot.

DIRECTABLE ARRAYS

The amateur confined to an apartment top or a small city lot is at a marked disadvantage when it comes to erecting antennas that will lay down a strong signal at distant points. Even at 10 and 20 meters it is difficult to string up arrays for various points of the compass without more ground space than is available to the average city amateur. And if the arrays are not placed just right or separated sufficiently, there will be coupling from one array to another, resulting in poor discrimination and directivity. As a result, the city amateur oftentimes turns to a rotatable affair, one which takes up but little ground space and can be aimed in the desired direction.

Arrays which give a large amount of gain are quite directional and are in greatest need of rotation. Unfortunately,

an array which is highly directional is relatively large, and rotation of such an array presents quite a problem except at 5 and possibly 10 meters. To be of practical size when used on 14 Mc., rotary antennas must be restricted to simple types with limited gain. The controllable directivity feature, however, makes them very useful, and a 20-meter array capable of being rotated can be designed to have sufficient gain to make such an installation worthwhile for the amateur unable to put up several beam antenna arrays.

Other methods of controlling directivity besides rotation are changing of phasing by means of a relay and the changing of reflector or director position without moving the radiator itself.

Still another answer to the cramped

quarters problem is the use of two bidirectional arrays that can be supported from a single pole without difficulty from mutual coupling, with provision for switching from one to the other.

SIMPLE UNIDIRECTIONAL ROTARY ARRAY

An effective unidirectional array which is small enough to be rotated without too much difficulty consists of a horizontal dipole and close-spaced reflector or director. Because a director is shorter physically than a reflector, the director combination is ordinarily used for reasons of compactness. Such a combination will actually provide some gain besides showing fair discrimination.

Because the director will minimize the effect of the earth upon the pattern of the driven dipole, the radiation from the dipole will be at lower, more useful angles. For this reason, a dipole of such height above ground that there is but little power radiated at low angles (a quarter wavelength above earth, for example) will oftentimes exhibit more than the theoretical 5-db gain when a director is added. If the dipole is far removed from earth, the gain will more nearly approach the theoretical value when a director is added.

If the director is self-resonant, the theoretical gain will be about 5.5 db, or maximum. However, a lobe appears to the rear which is only about 5 db lower in amplitude than the forward lobe. By shortening the director slightly so as to produce sufficient capacitive reactance to introduce approximately a -14 -degree phase angle, it is possible to increase the front-to-back ratio to approximately 17 db and still obtain nearly 5-db gain.

Because the adjustment of the director for maximum discrimination is quite critical, it must be accomplished by cut-and-try; it is not practical to cut the director according to a design table and then assume that it is correct. The radiator, however, is not so critical, and it may be cut safely to a predetermined length which, because of the reactance presented by the director, will be slightly longer than if it were resonated without the director being present. This leaves only the director adjustment to be made.

The common practice is either to prune the director an equal amount at either end or, in the case of tubing, to use telescoping end sections which may be slid in or out a few inches. This is awkward for two reasons: first, it is necessary to make *two* alterations each time in order to keep the system symmetrical and, second, it is difficult to reach the ends of the director if it is high above ground. Unfortunately, it is not the best practice to adjust the director at a height that can be reached easily and then raise the affair atop the pole. It is much better to make the director adjustments with the array at the height at which it is to be operated.

By making the director about a foot shorter than the probable length and splitting it at the center, the director may be adjusted from the *center*. This portion of the array is easily reached from the supporting pole, and center pruning requires only one adjustment. Thus, proper adjustment of the director length is greatly facilitated. The radiation resistance of a driven dipole when a director is spaced a tenth wave from it is close to 28 ohms *when the director is shortened slightly to give best front-to-back discrimination*. The exact value will depend to an extent upon the height above ground; it will always be fairly close to 28 ohms, however.

A highly satisfactory method of feeding a close-spaced array of the type under discussion is illustrated in the accompanying diagram. Two quarter-wave Q sections are utilized to transform the 28-ohm radiation resistance to an appropriate value for matching a two-wire open line. The first Q section consists of 72-ohm EO-1 twisted cable. Because the propagation along such a line is slower than for an open line, the quarter-wave section is only 11 feet long for 14.2 Mc.

The flexible nature of this cable provides a highly satisfactory method of connection to the rotatable dipole as it may be allowed to bang against guy wires without bad results and cannot short out by twisting over on itself. The quarter-wave section transforms the 28-ohm radiation resistance to about 195 ohms. This value is not high enough to produce excessive voltage across the EO-1 cable, and the cable will easily stand 400 watts in the antenna without heating or showing signs of breaking down.

While the use of EO-1 cable cannot ordinarily be indorsed for use as a Q section, it is quite permissible to use it as is done here because the impedance transformation is not very great. The losses in the cable will be very low by virtue of the short length required: 11 feet on 20 meters and 5.5 feet on 10 meters.

A 350-ohm Q section is used to transform the 195 ohms to 625 ohms, the latter being the surge impedance of the open line (no. 14 wire spaced 6 inches). This Q section consists of no. 10 wire spaced 1.2 inches and is 16.5 feet long. The small size (2-inch) Johnson spreaders will provide 1.2" spacing for the no. 10 wire if the two wires are run through the holes provided for the serving wires rather than fastened to the ends of the spacers.

This 350-ohm Q section may be run down the supporting pole, the top attaching to the EO-1 cable Q section and the bottom to the 625-ohm line. This arrangement requires that the 625-ohm line leave the pole considerably below the radiator and director. However, this is to be recommended, because if the feeders leave the pole only a few feet below the array, it will cause unbalance in the array at certain positions of rotation, and will cause the input to the transmitter to vary excessively as the array is rotated. The feeders also will distort the radiation pattern if they leave the pole too close to the dipoles.

Physical Construction

An excellent 20-meter array may be constructed by following the accompanying diagram. The new *thin-walled* galvanized steel conduit, available from most electrical supply houses in 10-foot lengths, is used as illustrated in order to permit a smaller wooden supporting structure. The conduit is not expensive and a 10-foot length in the $\frac{5}{8}$ " inside diameter size is quite rigid. Because of the high voltage present and for the sake of mechanical strength, large, $4\frac{1}{2}$ " ceramic standoff insulators are used to fasten the four lengths of conduit to the wooden supporting structure where indicated.

Besides the eight large standoff insulators and four lengths of conduit, the following are required: exactly 11 feet of EO-1 cable, 65 feet no. 10 wire, 18 2-inch ceramic spreaders with holes spaced 1.2 inches, sufficient no. 14 wire and 6-inch spreaders to reach from the pole to the transmitter.

Design of the wooden supporting structure and rotating mechanism will be left to the ingenuity of the individual constructor because so much has already appeared on the subject and because no two amateurs have the same idea as to the most desirable physical construction of their particular installation.

The easiest method of adjustment calls for a sensitive field strength meter placed at least a hundred feet from the

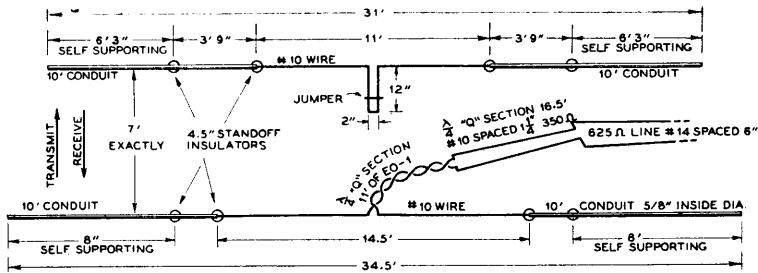

14.2 MC. UNIDIRECTIONAL ARRAY
ROTATABLE 7 X 18.5' WOODEN SUPPORTING STRUCTURE REQUIRED

FIGURE 60. PRACTICAL DESIGN FOR ROTARY CLOSE-SPACED UNIDIRECTIONAL ARRAY UTILIZING DOUBLE-Q MATCHING SYSTEM.

antenna and as high as possible. Lacking a field strength meter, enlist a *local* amateur who has a sensitive R meter on his receiver. The adjustment giving the best discrimination on the local ground wave will also give the best discrimination at distant points. An attempt to check with an amateur at a distant point while making adjustments will result in difficulty because of fading effects.

With the array pointed *away* from the assisting amateur or the field strength meter, slide the jumper (be sure low-resistance copper clips are used) towards the director an inch at a time. The antenna coupling at the transmitter should be adjusted each time to *keep the input to the transmitter the same*. As the jumper is slid towards the center of the dipole (electrically shortening the director), the field strength will decrease. When a certain critical point is reached, the field strength will start to increase. The jumper is adjusted (keeping the transmitter input constant) for minimum field strength, and then slid *away* from the director about one inch (lengthening it two inches). At this point the front-to-back discrimination will be greatest, and the forward gain will be only slightly, if any, less than the maximum obtainable.

This method of adjustment is simpler and quicker than rotating the array each time to check the front-to-back ratio and is just as accurate.

When this adjustment has been made, a check for standing waves should reveal nearly uniform current and voltage along the 625-ohm line. If standing waves are very noticeable, it indicates that an error has probably been made in trimming the director length as the radiation resistance will vary considerably from 28 ohms if the director length is off more than a very few inches.

Because of the heavy current flowing at the center of the director, the jumper should be replaced with a soldered shorting wire after the correct position has been determined.

This type of array is quite critical as to frequency though it may be used over the entire 20-meter band with fair success if cut for the middle of the band. A 14.2-Mc. array will have approximately the same forward gain over the whole band, but will exhibit noticeably better discrimination (front-to-back ra-

tio) at the center of the band than at the edges.

A 10-meter array can be constructed with both dipoles entirely of conduit, the director being split the same as illustrated for the 20-meter array to facilitate adjustment. Because the 10-meter band is so wide, it is advisable to cut the array either for 28.5 Mc. (for use from 28 to 29 Mc.) or for 29.5 Mc. (for use from 29 to 30 Mc.). Cutting the dimensions given for the 14.2-Mc. array in half will be approximately correct for a 28.5-Mc. array. Two 8'7" lengths of conduit could be used for the radiator of a 28.5-Mc. array, with two 7'8" lengths serving as the split adjustable director. The spacing between radiator and director would be 3.5 feet; a 3.5 ft. by 3.5 ft. rotatable wooden supporting structure would be sufficiently large. The 72-ohm EO-1 Q section would be 5.5 ft. long and the 350-ohm section would be about 8 ft. 3 inches long, the spacing remaining the same (1.2 inch).

For a 29.5-Mc. array the radiator length, the director length, the spacing between the two, the 72-ohm Q section, and the 350-ohm Q section should all be shortened by 3 per cent.

ROTATING FLAT-TOP BEAMS

A single-section flat-top beam (described in the preceding pages) makes as compact and simple a rotary array as does the close-spaced parasitic director arrangement just described. It has the advantage that it can be worked on its second harmonic even more effectively than on its fundamental if a tuned feeder is used rather than a matching stub and untuned line. The array is bidirectional and, therefore, need be rotated through only 180 degrees instead of 360 as required for a unidirectional system. This simplifies the swinging feeder problem.

Another advantage of the system is that the radiator dimensions are not critical so long as they are symmetrical and the feeders are tuned to resonance. The same holds for a stub-matched arrangement as proper adjustment of the shorting bar accomplishes the same thing. The use of a matching stub limits the use of the array to one band, somewhat offsetting the advantage of slightly

lower losses in the untuned transmission line as compared to tuned feeders.

The 32-foot supporting structure required for a 10- and 20-meter array may consist of a gondola-like affair constructed of varnished bamboo or spruce. The radiation resistance of the array is rather low and the voltage high, especially when worked on its fundamental; hence, excellent insulation is advisable.

ROTATING HEADS AND MECHANISMS

Rotation of either the close-spaced unidirectional array or the single-section Kraus beam entails quite a husky bearing. Whether or not the problem is simplified by rotating the whole mast is open to argument. If just the array itself is rotated, a highly satisfactory rotating head can be made from a polishing head procurable in most twenty-five cent to one dollar stores for around ninety cents. By turning this bearing on end and moving the shaft upward as far as allowable, so that the antenna will clear when rotated, the bearing problem is solved. Note that the entire weight of the antenna is on the setscrew which holds the small V pulley in the center—so be sure it is plenty tight. If a supporting structure of any weight is used, it might be well to drill into the shaft or flatten it at one point so the setscrew will have something to bite into.

The top belt pulley should be wide enough to allow for two turns of rope with a little to spare so the rope will not climb over itself when the antenna is turned. Since the small pulleys are placed

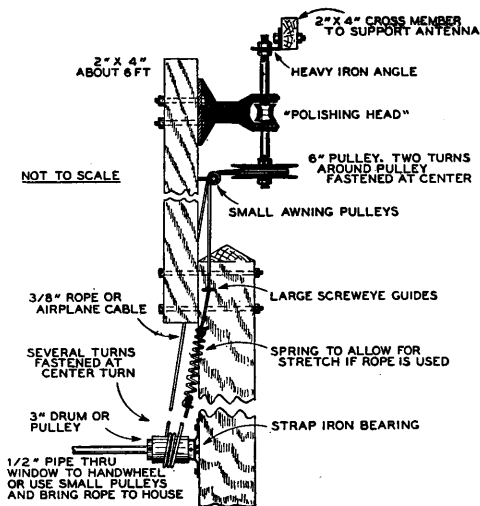

FIGURE 61.

only about three inches apart, the allowable rotation is considerably more than 360 degrees.

When rope is used for the belt, it is necessary to insert a spring at some point to allow for shrinkage when wet; otherwise, something may pull loose at one end or the other. This does not hinder the operation in any way except that there will be a slightly soft feeling when going one way because the spring will give a little before the antenna starts to turn.

If the rotating structure is too heavy to be supported by a polishing head, a saw mandrel or grinding head of suitable size may be utilized in the same manner. They are, however, more expensive.

U. H. F. ANTENNAS

The very-high frequency or *ultra-high-frequency* range may be said to extend from 30 megacycles to infinity. Frequencies higher than 300 Mc. (1 meter in wavelength) are usually classed as *micro waves*. The micro waves extend into the region of heat wave-lengths, thence into the wavelengths of light.

Very short radio waves behave very much like light waves and are not often reflected or refracted by the Heavyside layer. These radio waves are most useful

over optical paths, i.e., between points which are in visual range of each other. The wavelength used for radio communication in the u.h.f. range, however, is thousands of times greater than that of light, and there is a greater curvature of the paths of the radio waves. For this reason, the range is somewhat greater than can be obtained by means of light rays; signals can, therefore, be received from points beyond the horizon.

The range of transmission is governed

by the height of the transmitting and receiving antennas. Objects that lie in the path of the transmitted wave introduce a *shadow effect* which often prevents reception of the transmitted signal. This shadow effect can be overcome to some extent by using higher power in the transmitter.

Radio waves in the range of 56 to 60 Mc. occasionally are reflected back to earth by the Heaviside layer with the result that these signals can be heard over distances of a few hundred to a few thousand miles. This type of long-distance communication is extremely erratic, and the practical service of the ultra-high frequencies lies in the short-distance visual range. The occasional reflection of 5-meter signals from the Heaviside layer seems to depend upon sun spot activity and the season of the year, as well as the time of day.

At distances somewhat beyond the horizon, reception is often erratic because the atmosphere changes its temperature in layers close to the earth which, in turn, may change the amount of refraction and diffraction of the 5-meter signals. Refraction bends the radio waves into a curve along the earth's circumference and, therefore, increases the range of the radio wave beyond the optical distance.

Very little transmitter power is required for communication in the u.h.f. range over optical distances. The following formula can be used for calculating the optical range of transmission and reception:

$$X = \frac{2 d^2}{3},$$

where

X = height of the u.h.f. antenna in feet,
d = distance in miles.

This empirical formula can be used to calculate the height of an antenna in order to obtain any given distance of transmission to the optical horizon (in level country). If the receiving antenna is also located at some height above ground, the range will be increased and the same formula can again be used. For example, if the transmitting antenna is located at a height of 75 feet above ground, the transmission range will be found as follows:

$$75 = 2/3 \times d^2,$$

thus $d = 10.5$ miles.

If the receiving antenna is 30 feet high, the optical range can be found from the same formula, i.e., $30 = 2/3 \times d^2$ or $d = 6.7$ miles. The receiving station could, therefore, be located 6.7 + 10.5 or 17.2 miles from the transmitter and still be within the optical range. In this case, the radio wave will just graze the surface of the earth in reaching the receiving location and would tend to be reflected upward by the earth so that the signal at the receiving station would be considerably attenuated. The tendency of u.h.f. waves to be curved along the surface of the earth by the varying density of the troposphere compensates for the tendency of the earth itself to reflect the waves upward so that the calculated range can be maintained if no large objects lie between the transmitter and receiver locations.

Antenna Systems

The only difference between the antennas for ultra-high-frequency operation as compared with those for operation in other bands is in their physical size. The fundamental principles are unchanged.

Many types of antenna systems can be used for u.h.f. communication. Simple nondirective half-wave vertical antennas are desirable for general transmission and reception in all directions. Point-to-point communication is most economically accomplished by means of directional antennas which confine the energy to a narrow beam in the desired direction. If the power is concentrated into a narrow beam, the *apparent* power of the transmitter is increased a great many times.

The useful portion of a signal in the u.h.f. region for short-range communication is that which is radiated in a direction parallel to the surface of the earth. A vertical antenna transmits a wave of low-angle radiation which is vertically polarized.

Horizontal antennas can be used for receiving, with some reduction in noise. At points close to a transmitter using a vertical antenna, signals will be louder on a vertical receiving antenna. However, at distances far enough from the transmitter that the signal begins to get weak, the transmitted wave has no specific polarization and will appear ap-

proximately equal in signal strength on either a vertical or horizontal receiving antenna.

When used for transmitting, horizontal antennas radiate at too high a vertical angle to be effective for quasi-optical u.h.f. work. However, by using several horizontal elements in an array which

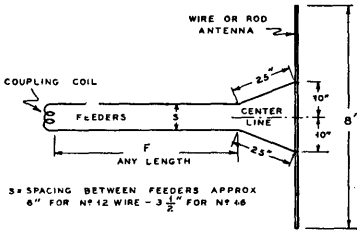

Figure 62. 5-meter matched-impedance antenna.

concentrates the radiation at low angles, results about as good as with vertically polarized arrays will be obtained.

The antenna system for either transmitting or receiving should be as high above earth as possible and clear of nearby objects. Transmission lines, consisting of concentric lines or spaced two-wire lines, can be used to couple the antenna system to the transmitter or receiver. Nonresonant transmission lines are more efficient at these frequencies than those of the resonant type.

Open lines should preferably be spaced closer than is common for longer wavelengths, as 6 inches is an appreciable fraction of a wavelength at 2½ and 5 meters. Radiation from the line will be minimized if 2-inch spacing is used rather than the more common 6-inch spacing.

It is possible to construct quite elaborate 5-meter directive arrays in a small space; even multi-element beams are compact enough to permit rotation. For this reason, it is more common to employ directional 5-meter arrays to obtain a strong transmitted signal than to resort to high power. Any of the arrays described in the section on directive antenna arrays can be used on 5 meters or 2½ meters, though those with sharp, low-angle vertical directivity will give the best results. Of the simpler types of arrays, those with their dipole elements

vertical give the lower angle of radiation, and are to be preferred. When a multi-element stacked dipole curtain is used, little difference is noticed between vertical and horizontal orientation.

Long-wire antennas such as the V and rhombic are not particularly satisfactory for 2½- and 5-meter work. Stacked dipole arrays are to be preferred.

An 8-foot aluminum rod may be connected 14% off center to the end of a 160-meter Marconi to allow both 5- and 160-meter operation. The rod may be held vertical by means of waxed fishline attached to one end. It will have less tendency to whip in a wind if oriented so that the heavy end is down. The rod will produce no bad effects when the antenna is used on 160 meters, and the arrangement will act as a single-wire-fed dipole on 5 meters.

Mobile U. H. F. Antennas

For 5-meter mobile application, the b.c.l. whip or fishpole auto antennas are highly satisfactory. Either a 4-foot length may be used as a Marconi against the car body, or an 8-foot length may be used as a vertical dipole. The latter, while delivering a stronger signal, is less commonly used due to the fact that it must be very well-insulated at the base and has a tendency to whip about quite a bit.

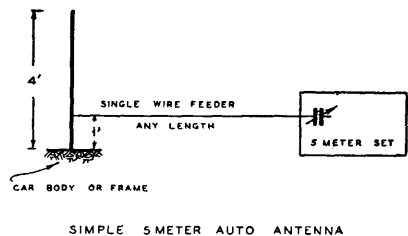

FIGURE 63.

The Marconi type may be fed either with a single wire feeder tapped 28% up from the base or by means of coaxial or twisted-pair line. Coaxial line constructed of copper tubing, with ceramic centering spacers holding the inner conductor, has the lowest loss. If single-

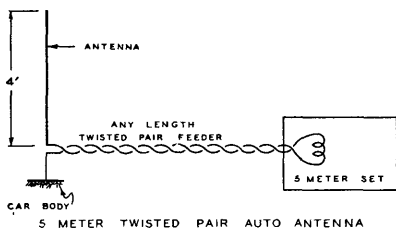

FIGURE 64.

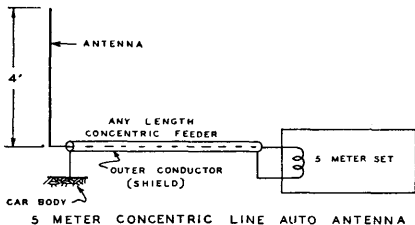

FIGURE 65.

wire feed is used, the Marconi antenna need not be insulated at the base. If twisted-pair or coaxial line is used, a base

insulator is necessary. However, the voltage at the base of a Marconi is quite low, and the insulation provided on commercially available b.c.l. fishpoles is adequate.

The efficiency of the Marconi can be increased by bonding the point to which the antenna mounts to several other points on the car body with heavy copper wire.

The coaxial or twisted-pair line is connected across the base insulator; no tuning provision need be provided. If the radiator is of the telescoping type, the length may be adjusted for maximum field strength. If coaxial line is used, the outer conductor should be grounded to the car frame not only at the base of the antenna but at several points between the antenna and transmitter.

Either the twisted-pair or coaxial line may be coupled to the transmitter or receiver by means of a one- or two-turn link.

The losses in twisted-pair and *rubber-insulated* coaxial lines are relatively high at 5 meters; but because only a short length is ordinarily required in a mobile installation, such a line is often used for the sake of convenience.

RECEIVING ANTENNAS

A receiving antenna should feed as much signal and as little noise—both man-made and atmospheric—to the receiver as possible. Placing the antenna as high as possible and away from house wiring, etc., will provide *physical* discrimination if a transmission line is used which has no signal pickup. Using a *resonant* antenna will provide *frequency* discrimination, attenuating signals and noise on frequencies removed from the resonant frequency of the antenna. Using a *directional* antenna will provide *directional* discrimination, attenuating signals and noise reaching the antenna from directions removed from that of the station transmitting the desired signal.

The ideal antenna has these three kinds of discrimination: physical, frequency and directional, which will thus deliver the most signal and the least amount of noise to the input circuit of the receiver. Such an antenna connected to a mediocre receiver will give better

results than will the best receiver made when working on a mediocre antenna.

All of the transmitting antennas previously described are suitable for receiving. A good transmitting antenna meets all three of the desirable requirements set forth above. For this reason, an amateur is seldom justified in erecting a separate antenna system for the purpose of receiving. A d.p.d.t. relay designed for r.f. use, working off the send-receive switch or the communications switch on the receiver, can be used to throw whatever transmitting antenna is being used at the time to the receiver input terminals.

Fortunately, the antenna that delivers the best signal into a certain locality will also be best for receiving from that locality, and conversely the antenna which provides the best received signal will be best for transmitting to the same locality. In fact, a rotary antenna can be aimed at a station for maximum

gain when transmitting by the simple expedient of rotating the array for maximum received signal.

As most man-made noise is essentially vertically polarized, an antenna or array with horizontal polarization will give minimum noise pickup from that source. For this reason, an array with horizontal polarization is advisable when it is to be used not only for transmission but also for reception.

The problem of noise pickup is most important because it is the signal-to-noise ratio that limits the signals capable of being received satisfactorily. No amount of receiver amplification will make a signal readable if the noise reaching the receiver is as loud as the signal. Peak-limiting devices will improve reception when trouble is experienced from *short-pulse* popping noises such as auto ignition interference. But no electrical device in the receiver is of avail against the steady buzzing, frying noises present in most urban districts.

For the latter type of interference, caused by power leaks, defective neon signs, etc., a recently developed modification of an old principle is oftentimes of considerable help. A noise antenna, a short piece of wire placed so as to pick up as much of the interfering noise and as little of the desired signal as possible, is fed to the input of the receiver *out of phase* with the energy received from the main antenna. By proper adjustment of coupling and experimentation with the length and placement of the noise antenna, it is sometimes possible to eliminate the offending noise completely. The system of noise bucking is described on pages 7-14 and in greater detail in the *RADIO Noise Reduction Handbook*.

Stray Pickup

More care has to be taken in coupling a transmission line to a receiver than to a transmitter. The whole antenna system, antenna and transmission line, may tend to act as a Marconi antenna to ground by virtue of capacity coupling. When transmitting, this effect merely lowers the maximum discrimination of a directive array with but little effect on the power gain; with a nondirectional antenna, nothing will even be noticed when there is a very slight amount of Marconi effect. But if the effect is present when *receiving*, there is little point

in using an antenna removed as far as possible from noise sources because the transmission line itself will pick up the noise.

Faraday Electrostatic Shield

There are two simple ways of avoiding the Marconi effect. The first method calls for a *Faraday screen* between the antenna coil of the receiver and the input grid circuit, and grounded. This eliminates all capacity coupling. This type of electrostatic screen can be constructed by winding a large number of turns of very small insulated wire on a piece of cardboard which has first been treated with insulating varnish. The wire is wound on, then another coating of varnish is applied.

After it has dried, *one edge* is trimmed with tin snips or heavy shears and the wires are soldered together along the opposite edge. The screen is placed between the two coils and grounded. If properly made, it has little effect on the inductive coupling as there are no closed loops.

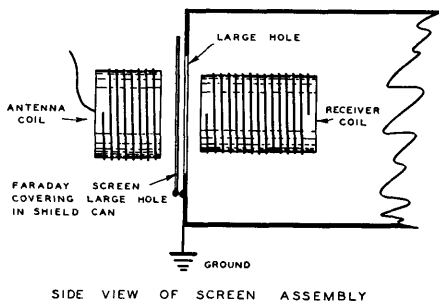
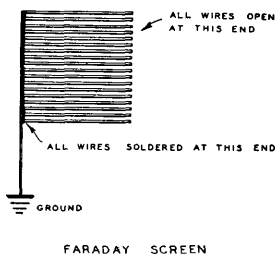

FIGURE 66.

Balancing Coils

The second method calls for a center-tapped antenna coil with the center tap grounded. If the coil is not easily accessible, a small center-tapped coil of from 5 to 30 turns is connected across the antenna input to the receiver and the center tap grounded. While not critical, the best number of turns depends upon the type of transmission line, the frequency and the turns on the antenna coil in the receiver. For this reason, the correct number of turns can best be determined by experiment.

The center tap must be at the *exact* electrical center of the coil. The coil may be scramble wound and made self-supporting by means of adhesive tape. It should be borne in mind that a twisted-

pair or open two-wire line will work *correctly* only if the receiver has provision for balanced (doublet) input. This is especially true of the latter type of line. If one side of the input or antenna coil is grounded inside the receiver, the ground connection must be broken and moved to the center of the coil or an external balancing coil used.

Another thing to take into consideration is the impedance of the input circuit of the receiver. If the receiver has high impedance input, it will not give maximum performance when a twisted-pair line is used. If it has low impedance input, it will not give maximum performance with an open line. Most receivers are designed with 200- to 300-ohm input and will work well with either type line.

SUPPORTING THE ANTENNA

The foregoing portion of this chapter has been concerned primarily with the *electrical* characteristics and considerations of antennas and arrays. The actual construction of these antennas is just as important. Some of the physical aspects and mechanical problems incident to the actual erection of antennas and arrays will, therefore, be discussed. Before going into detail on the construction of several specific types of masts, general problems and considerations incidental to the erection of most all antennas and arrays will be covered.

Up to 60 feet, there is little point in using mast-type antenna supports unless guy wires must either be eliminated or kept to a minimum. While a little harder to erect because of their floppy nature, fabricated wood poles of the type to be described will be just as satisfactory as more rigid types, *provided* lots of guy wires are used.

Rather expensive when purchased through the regular channels, 40- and 50-foot telephone poles can *sometimes* be obtained quite reasonably. In the latter case, they are hard to beat inasmuch as they require no guying if set in the ground six feet (standard depth) and the resultant pull in any lateral direction is not in excess of a hundred pounds or so.

For heights of 80 to 100 feet, either

three-sided or four-sided lattice type masts are most practicable. They *can* be made self-supporting, but a few guys will enable one to use a smaller cross section without danger from high winds. The torque exerted on the base of a high self-supporting mast is terrific during a 40- or 50-mile wind.

Guy Wires

Guy wires should never be pulled taut; a *small* amount of slack is desirable. Galvanized wire, somewhat heavier than seems sufficient for the job, should be used. The heavier wire is a little harder to handle, but costs only a little more and takes longer to rust through. Care should be taken to make sure that no kinks exist when the pole or tower is ready for erection as the wire will be greatly weakened at such points if a kink is pulled tight, even though it is later straightened.

If dead men are used for the guy wire terminations, the wire or rod reaching from the dead men to the surface should be of nonrusting material such as brass or given a heavy coating of asphalt or other protective substance to prevent destructive action by the damp soil. Galvanized iron wire will last only a short time when buried in moist soil.

Only strain-type (compression) insu-

lators should be used for guy wires. Regular ones might be sufficiently strong for the job, but it is not worth taking chances, and egg-type strain insulators are no more expensive.

Only a brass or bronze pulley should be used for the halyard, as a nice high pole with a rusted pulley is truly a sad affair. The bearing of the pulley should be given a few drops of heavy machine oil before the pole or tower is raised. The halyard itself should be of good material, preferably waterproofed. Hemp rope of good quality is better than window sash cord from several standpoints and is less expensive. Soaking it thoroughly in engine oil of medium viscosity and then wiping it off with a rag will not only extend its life but minimize shrinkage in wet weather. Because of the difficulty in replacing a broken halyard (procedure described later), it is a good idea to replace them periodically, without waiting for them to show excessive wear or deterioration.

Screw eyes should not be asked to stand pulling tension as ultimately wood loses its grip on them. They should be used only to hold guy wires and such *in position*; the wires should always be wrapped around the mast or pole. Nails will serve just as well, and are cheaper.

Trees

Often a tall tree can be called upon to support one end of an antenna, but one should not attempt to attach anything to the top as the swaying of the top of the tree during a heavy wind will complicate matters.

If a tree is utilized for support, provision should be made for keeping the antenna taut without submitting it to the chance of being severed during a heavy wind. This can be done by the simple expedient of using a pulley and halyard with weights attached to the lower end of the halyard to keep the antenna taut. Only sufficient weight to avoid excessive sag in the antenna should be tied to the halyard as the continual swaying of the tree submits the pulley and halyard to considerable wear.

Galvanized iron pipe or steel tube conduit is often used as a vertical radiator and is quite satisfactory for the purpose. However, when used for supporting antennas, it should be remembered that the grounded supporting poles will dis-

tort the field pattern unless spaced some distance from the radiating portion of the antenna.

Painting

The life of a wood mast or pole can be increased several hundred per cent by protecting it from the elements with a coat or two of paint. And, of course, the appearance is greatly enhanced. The wood should first be given a primer coat of flat white outside house paint, which can be thinned down a bit to advantage with second-grade linseed oil. For the second coat, which should not be applied until the first is thoroughly dry, *aluminum paint* is not only the best from a preservative standpoint but looks very well. This type of paint when purchased in quantities is considerably cheaper than might be gathered from the price asked for quarter-pint cans.

The type of wood used for the pole or uprights for the mast is not particularly important so long as it is strong, straight-grained with no knots, and rough-finished (unsurfaced).

Portions of posts or poles below the surface of the soil can be protected from termites and moisture by painting with creosote. While not so strong initially, redwood will deteriorate much more slowly when buried than will the white woods such as pine.

Antenna Wire

The antenna or array itself presents no especial problem. A few considerations should be borne in mind, however. For instance, soft-drawn copper should not be used as even a short span will stretch several per cent after whipping around in the wind a few weeks, thus affecting the resonant frequency. Enamelled-copper wire as ordinarily available at radio stores is usually soft drawn, but by tying one end to some object such as a telephone pole and the other to the frame of an auto, a few husky tugs can be given and the wire, after stretching a bit, is equivalent to hard drawn.

Where a long span of wire is required, or where heavy insulators in the center of the span result in considerable tension, copper-clad steel wire is somewhat better than hard-drawn copper. It is a bit more expensive though the cost is far from prohibitive. The use

of such wire, in conjunction with strain insulators, is advisable where the antenna would endanger persons or property should it break.

The use of copper tubing for antennas is not only expensive but unjustifiable. Though it was a fad at one time, there is no excuse for using anything larger than no. 10 copper or copper-clad wire for any power up to one kilowatt. In fact, no. 12 will do the trick just as well and passes the underwriter's rules if copper-clad steel is used. For powers of less than 100 watts, the underwriter's rules permit no. 14 wire of solid copper. This size is practically as efficient as larger wire, but will not stand the pull that no. 12 or no. 10 will, and the underwriter's rules call for the latter for powers in excess of 100 watts if solid copper conductor is used.

More important from an electrical standpoint than the actual size of wire used is the soldering of joints, especially at current loops in an antenna of low radiation resistance. In fact, it is good practice to solder *all* joints, thus insuring quiet operation when the antenna is used for receiving.

Insulation

A question that often arises is that of insulation. It depends, of course, upon the r.f. voltage at the point at which the insulator is placed. The r.f. voltage, in

turn, depends upon the distance from a current node and the radiation resistance of the antenna. Radiators having low radiation resistance have very high voltage at the voltage loops; consequently, better-than-usual insulation is advisable at those points.

Open-wire lines operated as nonresonant lines have little voltage across them; hence, the most inexpensive ceramic types are sufficiently good electrically. With tuned lines, the voltage depends upon the amplitude of the standing waves. If they are very great, the voltage will reach high values at the voltage loops, and the best spacers available are none too good. At the current loops, however, the voltage is quite low and most anything will suffice.

When insulators are subject to very high r.f. voltages, they should be cleaned occasionally if in the vicinity of sea water or smoke. Salt scum and soot are not readily dislodged by rain, and when the coating becomes heavy enough, the efficiency of the insulators is greatly impaired.

If a very pretentious installation is to be made, it is wise to check up on both underwriter's rules and local ordinances which might be applicable. If you live anywhere near an airport and are contemplating a tall pole, it is best to investigate possible regulations and ordinances pertaining to towers in the district before starting construction.



CHAPTER 5

In the Workshop

Tools—Construction Hints—Handy Workshop Kinks—Racks

MASS PRODUCTION, especially when the parts are of the type used in construction and replacement work on b.c.l. receivers, has brought the cost of the individual components required in the construction of amateur transmitters down to where it hardly pays one to attempt to build them. There may be a few exceptions, such as fixed air condensers and wire-wound transmitting coils, but ordinarily there is little justification for attempting to build the individual pieces of apparatus that make up a radio transmitter.

Transmitters

However, the incorporation of the various components into a finished transmitter presents a different story. Those who have and wish to spend the necessary time can effect considerable monetary saving in their transmitters by building them from the component parts from the data given in the construction chapter of this handbook. To many, the construction is as fascinating as the operation of the finished transmitter; in fact, many amateurs get so much satisfaction out of building a well-performing piece of equipment that they spend more time constructing and rebuilding equipment than they do operating the equipment on the air.

Those who are not mechanically minded and are more interested in the pleasures of working dx and rag chewing than in experimentation and construction will find on the market many excellent transmitters which require only line voltage and an antenna. If you are one of those amateurs, you will find little to interest you in this chapter; your time will be better spent in studying the antenna chapter from which may be ob-

tained many excellent ideas on antennas which will raise your signal strength reports.

Receivers

There is room for argument as to whether one can save money by constructing his own communications receiver. The combined demand for these receivers by the government, amateurs, airways, short-wave listeners and others has become so great that it may be argued that there is no more point in building such a receiver than in building a regular broadcast set. However, many amateurs still prefer to construct their own receivers—in spite of the fact that it costs almost as much to build a receiver as to purchase an equivalent factory made job—either because they enjoy construction work and take pride in the fruits of their efforts or because the receiver must meet a certain set of requirements and be built as inexpensively as possible.

The only factory made receiver that is sure to meet the requirements of every amateur or short-wave listener is the rather expensive de luxe type having every possible refinement. An amateur of limited means who is interested only in c.w. operation on two or three bands, for instance, can build himself at a fraction of the cost of a de luxe job a receiver that will serve his particular purpose just as well. In the receiver construction chapter are illustrated several relatively inexpensive special-purpose receivers which, for the particular purpose for which they were designed, will give as good results as can be obtained from any factory built receiver regardless of cost.



Figure 1. Most any corner having room for a bench and lots of drawer space can serve as the amateur's workshop. Drawers are preferable to shelves for storing radio parts since they will protect equipment from dust.

TYPES OF CONSTRUCTION

Breadboard

The simplest method of constructing equipment is to lay it out breadboard fashion, which consists of screwing the various components to a board of suitable size, arranging the parts so that the important leads will be as short as possible.

While this type of construction is also adaptable to receivers and measuring and monitoring equipment, it is used principally for transmitter construction and remains a favorite of the high-power c.w. amateurs. An example of breadboard construction will be found on page 340.

Breadboard construction requires a minimum of tools; apparatus can be constructed breadboard fashion with the aid of only a rule, screwdriver, ice pick, saw and soldering iron. A hand drill will also be required if it is desired to run part of the wiring underneath the breadboard. Ordinary carpenter's tools will be satisfactory.

Metal Chassis

Though quite a few more tools and considerably more time will be required for construction, much neater equipment can be built by mounting the parts on sheet metal chassis instead of breadboards. This type of construction is advisable when shielding of the apparatus is necessary as breadboard construction does not particularly lend itself to shielding. The appearance of the apparatus may be further enhanced by incorporating a front panel upon which the various controls are placed, though a front panel is not absolutely necessary. (See the equipment illustrated on page 392.)

If sufficient pains are taken with the construction and a front panel is used in conjunction with either a dust cover (cabinet) or enclosed relay rack, the apparatus can be made to rival or even to resemble factory built equipment in appearance.

TOOLS

Beautiful work can be done with metal chassis and panels with the help of only a few inexpensive tools. However, the time required for construction will be

greatly reduced if a fairly complete assortment of metal working tools is available. Thus, it can be seen that while an array of tools will speed up the work,

excellent work can be accomplished with but few tools if one has the time and patience.

The investment one is justified in making in tools is dependent upon several factors. If you like to tinker, there are many tools useful in radio construction that you would probably buy anyway or already have, such as screwdrivers, hammer, saws, square, vise, files, etc. This means that the money taken for tools from your radio budget can be used to buy the more specialized tools, such as socket punches or circular saws, long-nosed pliers, etc.

The amount of construction work one does determines whether one is justified in buying a large assortment of tools and whether one should buy the less expensive type offered at surprisingly low prices by the familiar mail order houses, "five and ten" stores and chain auto-supply stores, or whether one should spend more money and get first-grade tools. The latter cost considerably more and work but little better when new, but will outlast several sets of the cheaper tools and, therefore, are a wise investment for the experimenter who does lots of construction work (if he can afford the initial outlay). The amateur who constructs only an occasional piece of apparatus need not be so concerned with tool life, as even the cheaper grade tools will last him several years if they are given proper care.

The following hand tools and materials will be found very useful around the home workshop. Those marked with a double asterisk are essential. The single asterisk denotes tools next in importance, which should be bought as soon as possible after stocking up with the "must" equipment. Materials not listed but ordinarily used, such as paint, can best be purchased as required for each individual job.

- 1 Cheap carpenter's claw hammer
- * 1 Good ball pien hammer, $\frac{3}{4}$ or 1 lb.
- * 1 Hacksaw with coarse and fine blades, 10 or 12 in.
- 1 Jig or scroll saw (small) with metal-cutting blades
- 1 Small wood saw (crosscut teeth)
- * 1 Bench vise (jaws at least $3\frac{1}{2}$ in.)
- ** 1 Good electric soldering iron,

about 100 watts, with "radio" tip

- /* 1 Spool rosin-core wire solder
- * 1 Spool plain wire solder
- ** 1 Jar soldering paste (noncorrosive)
- /* 1 Ea. large, medium, small and midget screwdrivers
- /* 1 Good hand drill, preferably two-speed
- * 1 Pr. regular pliers, 6 in.
- ** 1 Pr. long nose pliers, 6 in.
- /* 1 Pr. cutting pliers (diagonals), 5 in. or 6 in.
- * 1 Carpenter's brace, ratchet type
- 1 Square-shank screwdriver bit
- 1 Ea. Square-shank drills: $\frac{3}{8}$, $\frac{7}{16}$, and $\frac{1}{2}$ in.
- * 1 Square-shank countersink
- 1 Square-shank taper reamer, small
- * 1 Square-shank taper reamer, large (the two reamers should overlap; $\frac{1}{2}$ in. and $\frac{3}{8}$ in. size will usually be satisfactory)
- * 1 Square-shank adjustable circle cutter for holes to 3 in.
- * 1 Set small, inexpensive, open-end wrenches
- 1 Ea. "Spintite" wrenches, $\frac{1}{4}$ and $\frac{5}{16}$ in. to fit standard 6-32 and 8-32 nuts used in radio work and two common sizes of Parker Kalon metal screws
- * 1 Pr. tin shears, 10 or 12 in.
- ** 1 "Boy Scout" knife
- ** 1 Combination square and steel rule, 1 ft.
- ** 1 Yardstick or steel pushrule
- 1 Carpenter's plane, 8 in. or larger
- * 1 Cold chisel ($\frac{1}{2}$ in. tip)
- * 1 Wood chisel ($\frac{1}{2}$ in. tip)
- * 1 Pr. wing dividers
- ** 1 Scratch awl or ice pick scribe
- 1 Metal punch
- ** 1 Center punch
- * 1 Coarse mill file, flat, 12 in.
- * 1 Coarse bastard file, round, $\frac{1}{2}$ or $\frac{3}{4}$ in. dia.
- * 6 or 8 Assorted small files:
 - *round, half round, *triangular, *flat, square, rat-tail, etc.
- ** 1 doz. or more assorted round shank drills (as many as you can afford between no. 50 and $\frac{1}{4}$ or $\frac{3}{8}$ in., depending upon size of hand drill chuck)
- 1 Tap and die outfit for 6-32 and 8-32 machine screw threads

(A whole set is not necessary as other sizes will be seldom needed)

- * 4 Small "C" clamps
- 4 Medium size "C" clamps
- ** 1 Combination oil stone
- * Steel wool, coarse and fine
- * Sandpaper and emery cloth, coarse, medium and fine
- Lard oil (in squirt can)
- ** Light machine oil (in squirt can)
- Kerosene
- Duco cement
- ** Friction tape
- * Rubber cement
- Empire cloth
- Alcohol
- Clear lacquer ("industrial" grade)
- Lacquer thinner
- * File card or stiff brush

Dusting brush
Paint brushes
Sheet celluloid
Acetone

The foregoing assortment assumes that the constructor does not want to invest in the more expensive power tools, such as drill press, grinding head, etc. If power equipment is purchased, obviously some of the hand tools and accessories listed will be superfluous.

Not listed in the table are several special-purpose radio tools which are somewhat of a luxury but are nevertheless quite handy, such as socket hole punches, various around-the-corner screwdrivers and wrenches, special soldering iron tips, etc. These can be found in the larger radio parts stores and are usually listed in their mail order catalogs.

CONSTRUCTION HINTS

Chassis Layout

The first step in chassis type construction is the arrangement of the parts and the transformation of their mounting holes to marking on the chassis. Instead of marking guide lines on the chassis itself, lay them out on a sheet of paper to scale and then attach the paper to the chassis with rubber cement. The hole centers and other necessary markings can be punched right through the paper, and then it can be removed. The rubber cement rubs off easily and actually helps to clean the chassis as an eraser would. A further simplifying step is to use one-inch cross section paper for this work. This automatically obviates the necessity for machinist's or T-squares for obtaining the right angles, and also eliminates the use of a ruler for all but oblique lines and circles.

Drilling

Although most of us do not so consider it, a twist drill is nothing more than a modified jackknife. It has a cutting edge, an angle of clearance and an angle of rake, just as has a jackknife (or a lathe tool). The technique to be followed in drilling is, therefore, a function of the type of material worked on, as well as the speed and accuracy desired. In figure 2 is shown in heavy lines one of the cut-

ting edges of a drill normally used on steel. The angle B, between the cutting edge and the piece being worked on, is the angle of clearance. This determines to some extent how heavy a cut may be taken. Figure 3 shows the drill in action. Note that as the drill proceeds, the chip cut out is above the cutting edge. This has the effect of pushing the drill farther into the material. This is determined by the angle of rake, angle A, and the hardness of the material. If the material is hard at the point of cutting, the resistance to downward motion here is great enough to oppose that generated by the angle of rake.

Figures 2 and 3 show the shape of the cutting edge for steel or iron. This is satisfactory for steel or iron. The shavings which come out of the hole around the drill should be spiral and continuous as shown in figure 3. For softer metals, especially brass, the drill should have no angle of rake (or lip, as the forward projecting cutting edge is called). This is shown in figure 4. The shavings for this drill will be small chips. If this shape drill is not used, the drill will feed into the metal very rapidly and will usually jam. The result is a stalled motor, a belt off its pulley or a broken drill. The latter is usually the case.

As the tip of a drill is not a point, but a straight line perpendicular to its major

axis, a drill will usually waltz all over the piece before it starts to drill unless a guide hole is punched at the point you wish to drill. The maximum diameter of this hole should be at least equal to the width of the drill tip. This is designated as D in figures 5 and 6, the latter showing a cross section of the center-punch mark. With drills of over 1/4" diameter, this method of starting the drill is usually impractical as the diameter of the center-punch hole is prohibitively large. This difficulty is avoided by first drilling a smaller guide hole which can be started with a center-punch hole.

A great deal could be said about drilling speeds and feeds, but it would be of little value to the average person. In drilling steel or iron, the drill point should be well lubricated with a medium grade of machine oil. The weight of oil commonly used in oiling lawn mowers is about correct. This serves a double function for most machinists. The first, of course, is lubrication. The second is to keep the work cool. The oil flows from hot points to cold ones more quickly than heat flows from the hot points of the drill to the cooler ones. But, for ham use, the oil assumes a third role, that of a temperature indicator. The oil should never evaporate visibly to form a cloud around the work (this vapor looks like steam).

Another indicator is that you should be able to hold the end of the drill in your hand with no discomfort immediately after you have finished the hole. These considerations are based on the assumption that most hams use the average carbon drill, and not one of the more expensive type designed to operate at high temperatures. Most tool steel will start to lose its hardness at a little over 100

NUMBERED DRILL SIZES

Drill Number	Diameter (in.)	Clears Screw	Correct for Tapping Steel or Brass †
1	.228		
2	.221	12-24	
3	.213		14-24
4	.209	12-20	
5	.205		
6	.204		
7	.201		
8	.199		
9	.196		
10*	.193	10-32	
11	.191	10-24	
12*	.189		
13	.185		
14	.182		
15	.180		
16	.177		12-24
17	.173		
18*	.169	8-32	
19	.166		12-20
20	.161		
21*	.159		10-32
22	.157		
23	.154		
24	.152		
25*	.149		10-24
26	.147		
27	.144		
28*	.140	6-32	
29*	.136		8-32
30	.128		
31	.120		
32	.116		
33*	.113	4-36 4-40	
34	.111		
35*	.110		6-32
36	.106		
37	.104		
38	.102		
39*	.100	3-48	
40	.098		
41	.096		
42*	.093		4-36 4-40
43	.089	2-56	
44	.086		
45*	.082		3-48

† Use next size larger drill for tapping bakelite and similar composition materials (plastics, etc.).
* Sizes most commonly used in radio construction.

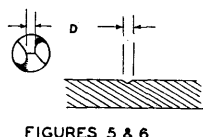
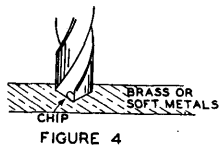
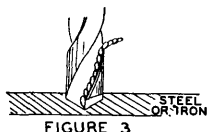
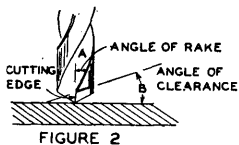

degrees C. At 600 degrees, it is as soft as mild steel, and must be heat treated and tempered again. That means that most hams would have to grind the softened portion off and then attempt to re-grind the cutting edges.

Brass should always be drilled with no lubricant. For one thing, the brass slides readily against steel. Bronze is in the same class. Witness the large number of bronze bearings in current use. Almost all of the zinc alloys may so be treated. If a lubricant is used, it usually only makes the particles cling together and thus clog the drill point. Alumi-

num is sometimes lubricated with kerosene.

The drilling speed (number of revolutions per minute of the drill) and the drilling feed (rate at which the drill is pushed into the work) are interdependent. The safe simple way to determine them is to watch the temperature. If the drill is running too hot, decrease the feed. If it still runs too hot, decrease the speed. In drilling, it is a safe practice never to feed the drill in a distance greater than the diameter of the drill without backing it off until the work is clear. This permits you to examine the point and permits the drill to clear itself of particles which may be clogging it at the point of cutting. This looks like a waste of time, but actually will be a time saver. You won't have to stop to replace broken and softened drills.

Danger

Most drill presses are equipped with some means of clamping the work. It is always wise to use these, unless the piece is large and the holes are small. A piece, especially of sheet steel, which gets jammed on the drill and tears out of the operator's hands, is a dangerous weapon. With small pieces, it is always best to clamp them in a tool maker's vise. Larger pieces may be clamped as shown in figure 7.

When working with sheet steel (as you usually are on chassis construction), if the piece is large, you may hold it safely by hand. Wear gloves and hold the work *firmly* with both hands. The drill feed may be easily arranged to operate by foot for these operations. Figure 8 shows how this is done. The spring shown is a screen door spring. The distance A from the hinge determines the ratio between foot motion and drill feed. The illustration is otherwise self-explanatory. For any hams interested in cutting operations other than drilling, the same principles as set forth here apply.

Punching

In cutting socket holes, one can use either a fly-cutter or socket punches. These punches are easy to operate and only a few precautions are necessary. The guide pin should fit snugly in the guide hole. This increases the accuracy of location of the socket. If this is not

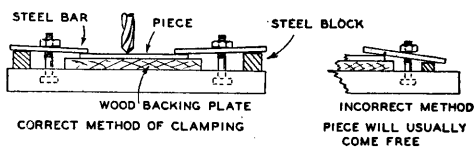

FIGURE 7

of great importance, one may well use a drill of $1/32$ " larger diameter than the guide pin. Some of the punches will operate without guide holes, but the latter always make the punching operation simpler and easier. The only other precaution is to be sure the work is properly lined up before applying the hammer. If this is not done, the punch may slide sideways when you strike and thus not only shear the chassis but also take off part of the die. This is easily avoided by always making sure that the piece is parallel to the faces of the punch, the die and the base. The latter should be an anvil or other solid base of heavy material.

Removing Burrs

In both drilling and punching, a burr is usually left on the work. There are three simple ways of removing these. Perhaps the best is to take a chisel (be sure it is one for use on metal, as the ones for wood are not much harder than the average chassis steel) and set it so that its bottom face is parallel to the piece (in other words, has zero angle of clearance). Then gently tap it with a hammer. This usually will make a clean job with a little practice. If one has access to a counterbore, this will also do a nice job. But few of us can find one to work with. A countersink will work, although it bevels the edges. A drill of several sizes larger is a much used arrangement. The third method is by filing off the burr, which does a good job but scratches the adjacent metal surfaces badly. Any of these methods will work, but the first is quicker and does a neater job.

Transformer Cutouts

Cutouts for transformers and chokes are not so simply handled. There are devices on the market for this, but they have not yet come into common use. After marking off the part to be cut, drill about a $1/4$ " hole on each of the inside

corners and tangential to the edges. After burring the holes, clamp the piece and a block of cast iron or steel in the vise as shown in figure 10. Then, take your burring chisel and insert it in one of the corner holes. Cut out the metal by hitting the chisel with a hammer. The blows should be light and numerous. The chisel acts against the block in the same way that the two blades of a pair of scissors work against each other. This same process is repeated for the other sides. A file is used to trim up the completed cutout.

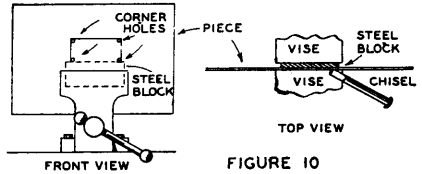

FIGURE 10

Folding

Folding the chassis may be accomplished either by hand or by machine (a brake or folder). If it is done by hand, the work is set up in the vise just as it was for cutting out transformer mounting holes. But for this work, it is best to have a block on each side of the piece. These blocks should extend the width of the piece. It is then folded over by hand, being careful to have all of it bending the same amount at any time. If your hands aren't big enough to apply uniform pressure on all parts of the bend at once, they may be supplemented by a wooden block held so that it is parallel to the fold and extends the width of the piece. The fold is then completed by hammering.

In this type of folding, the bend is very sharp. Therefore, you should add only the thickness of the metal to the measured distance between edges to obtain the overall dimension. Figure 11 shows this. The dotted lines indicate the positions of the block used in folding the piece. This overall dimension is fre-

quently quite important, and care exercised here will produce a chassis which properly fits into its box.

If machine folds are made, this overall dimension is easily obtained. This is shown in figure 12. It is advisable to bend up a piece of scrap material first to be sure that the machine's stops are set properly to fold a right angle for the material you are using.

In bending sheet steel or iron, it is not necessary to watch for grain. But in rolling out sheet zinc, some brasses, aluminum and softer metals, the strength of the metal perpendicular to the rollers is greater than that at right angles to this direction. This *grain*, as it is called, is very similar to that of wood. It is usually visible as stripes on the face of the metal. Therefore, one should be very careful in folding or bending materials which have this weakness. The folds should always be at right angles to the lines showing the grain. If this is not possible, the folds should have a somewhat larger radius of curvature, and should not be as sharp as they usually are made. In hand folding, this means that you cannot complete the job with a hammer as suggested, but must leave it as is. The best plan is to test out a sample of the material before folding the actual chassis.

Assembling

In chassis made of several pieces, and in construction in which the chassis must be fastened to the front panel, shielding partitions, etc., a knowledge of metal fastenings is useful. Metals may be fastened together by a number of common methods. These are rivets, nuts and screws, screws and tapped holes, self-tapping screws, and welding. These are listed in the reverse order of their general value to the ham for steel chassis. In riveting, the chassis usually gets warped. Nuts and screws are expensive and take time to assemble. Tapped holes are a nuisance to make.

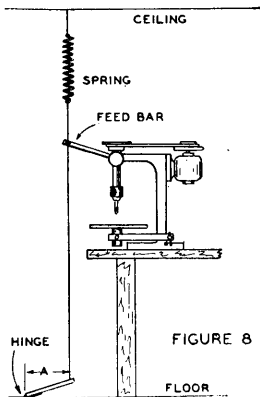

FIGURE 8

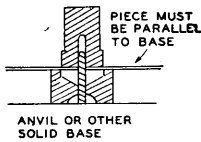

FIGURE 9

But self-tapping screws are quick, cheap and make a fairly good joint. Welding makes the best joint of them all, but has the disadvantage of being permanent.

Many machine shops now have spot-welding equipment, and can usually be persuaded to weld up a box or chassis for little or nothing. For this work, it is usually best to have the work held together by C-clamps or similar means while it is being welded. The work should always be well cleaned with lacquer thinner or similar compounds.

For metals other than steel, spot welding is usually not very successful. And, as most of the other metals commonly used in chassis construction are not hard enough to hold a good thread, nuts and bolts seem to be the only solution. Soldering is sometimes used, but it is not to be recommended.

Finishes

There are a number of ways of finishing the chassis. Perhaps the best for steel is plating. Cadmium plating was once popular, but since one of the automobile manufacturers is reputed to have a corner on this material, it has been hard to get. Chromium plating is pretty, but is expensive and hard to solder to. Copper plating tarnishes, but can be covered with colorless lacquer and made to be a very beautiful finish. Other materials may be best treated by polishing them and then covering with colorless lacquer. A very pretty, dull gloss finish, almost velvety, can be put on aluminum by sand-blasting it with a very weak blast and fine particles and then lacquering it. Soaking the aluminum in a solution of lye produces somewhat the same effect as a fine grain sand blast.

There are also several brands of dull gloss black enamels on the market which adhere well to metals and make a nice appearance. Air-drying crackle finishes are sometimes successful, but a baked job is usually far better. Crackle finishes, properly put on, are very durable and are pleasing to the eye. If you live in a large community, there is probably an enamelling concern which can crackle your work for you at a reasonable cost. A very attractive finish for panels especially is to spray a crackle finish with aluminum paint. In any painting oper-

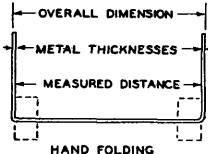

FIGURE 11

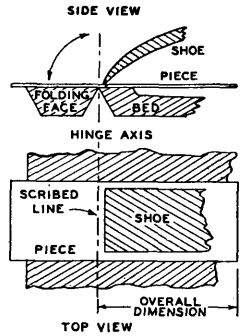

FIGURE 12

ation (or plating either for that matter), the work should be very thoroughly cleaned of all greases and oils.

Soldering

A prerequisite to a good soldering job is a good iron. If one can afford two irons, a 150-watt size for heavy work and a smaller 75-watt size for getting into tight places are highly desirable. However, a single 100-watt iron will do nicely for most purposes.

Do not get a high wattage iron that is relatively small physically. Such an iron must be used continuously to keep it from becoming too hot. When such an iron is left plugged in and is not used for several minutes, the iron will become so hot that it will curdle the solder adhering to the tip, making frequent filing and retinning necessary. An aluminum rest which presents considerable surface to the air and to the iron will prevent an iron from becoming overheated when not in actual use. Such a heat-dissipating rest for the iron can be made from an old aluminum automobile piston by sawing it off crosswise at the wrist pin.

The important thing to remember in regard to the actual soldering operation is to have the tip of the iron clean and the *joint* both clean and *hot*. The solder should be applied to the *joint*, not to the iron. If the iron will not heat the joint sufficiently for the solder to melt and flow into it, a heavier or hotter iron will be required. An excellent technique is to apply the iron to the bottom side of the joint and the solder to the top of the joint; when the joint becomes sufficiently hot, the solder will flow down into it.

Ordinarily, soldering paste will not be

required; rosin-core solder will do the trick for most joints encountered in radio work if the metals to be joined are bright and shiny and have no film of grease. But, occasionally, it will be necessary to resort to soldering paste. It should be of the noncorroding type, and should be used sparingly. Warm the joint with the iron, apply a small amount of paste to the joint and then solder as usual, but using plain wire solder instead of rosin-core type. After the joint is made, it is a good idea to wipe off the excess paste with a clean rag while the joint is still warm; otherwise, the paste remaining will cause dust to collect on

the joint and produce a messy appearance.

When joining wires, approved practice calls for a mechanically sound joint before the solder is applied. The solder should not be depended upon to provide mechanical strength. This is a good idea in any case, is absolutely necessary in the case of mobile and other apparatus subject to mechanical vibration.

When the tip of the soldering iron becomes pitted, it should be filed clean (while hot) with a coarse file and retinned either with the aid of soldering paste or sal ammoniac.

HANDY WORKSHOP KINKS

To Resharp Old Files

Wash the files in warm potash water to remove the grease and dirt, then wash in warm water and dry by heat. Put one and one-half pints warm water in a wooden vessel, put in the files, add three ounces blue vitriol finely powdered, three ounces borax. Mix well and turn the files so that every one may come in contact with the mixture. Add ten and one-half ounces sulphuric acid and one-half ounce cider vinegar. Remove the files after a short time, dry, rub with olive oil, wrap in porous paper. Coarse files should be kept in the mixture for a longer time than fine ones.

File Lubricant

When filing aluminum, dural, etc., the file should be oiled or rubbed in chalk, but will cut slower than with no lubricant. However, the file will last much longer.

Screw Lubricant

Put hard soap on lag screws, wood screws or any screw for wood. It will surprise you how much easier they will turn in and prevent or at least reduce splitting.

Drilling Glass

This is done very readily with a common drill by using a mixture of turpentine and camphor. When the point of

the drill has come through, it should be taken out and the hole worked through with the point of a three-cornered file, having the edges ground sharp. Use the corners of the file, scraping the glass rather than using the file as a reamer. Great care must be taken not to crack the glass or flake off parts of it in finishing the hole after the point of the drill has come through. Use the mixture freely during the drilling and scraping. The above mixture will be found very useful in drilling hard cast iron.

Etching Solution

Add three parts nitric acid to one part muriatic acid. Cover the piece to be etched with beeswax. This can be done by heating the piece in a gas or alcohol flame and rubbing the wax over the surface. Use a sharp steel point or hard lead pencil point as a stylus. A pointed glass dropper can be used to put the solution at the place needed. After the solution foams for two or three minutes, remove with blotting paper and put oil in the piece and then heat and remove the wax.

Annealing Brass or Copper

Brass or copper when worked will become hard and, if hammered to any great extent, will split. To prevent cracking or splitting, the piece must be heated to a dull red heat and plunged into cold water; this will soften it so it can be worked easily. Be careful not to heat

brass too hot or it will fall to pieces.

To Clean Copper

Prepare a strong soda or potash lye solution by adding about a pound of lye to a pail of boiling water. Dip the metal or apply this solution with a brush, scrubbing well. Then rinse or wash with plain hot water and finally with cold water.

To Protect Brass from Tarnish

Thoroughly cleanse and remove the last trace of grease by the use of potash and water. The brass must be carefully rinsed with water and dried; but in doing it, care must be taken not to handle any portion with the bare hands nor anything else that is greasy. The preservative varnish is made by mixing two parts of shellac to nine parts of alcohol. Put on with a brush as thin and smooth as possible.

Polish for Bakelite and Crackle Finish

Mix two parts benzine with one part mineral oil and apply with cloth. Wipe with dry cloth. This is not a messy polish and does not leave an oily surface.

Chromium Polish

So much chromium is now being used in radio sets and panels that it is well to know that this finish may be polished.

The only materials required are absorbent cotton or soft cloth, alcohol and ordinary lamp black.

A wad of cotton or the cloth is moistened in the alcohol and pressed into the lamp black. The chromium is then polished by rubbing the lamp black adhering to the cotton briskly over its surface. The mixture dries almost instantly and may be wiped off with another wad of cotton.

The alcohol serves merely to moisten the lamp black to a paste and make it stick to the cotton. The mixture cleans and polishes very quickly and cannot scratch the chromium surface. It polishes nickel-work just as effectively as it does chromium.

To Color Brass a Steel Blue

Dissolve three drams antimony sulphite and four ounces calcined soda in one and one-half pints water. To this add five and one-half drams kermes. Filter and mix this solution with five and one-half drams tartar, eleven drams sodium hyposulphate and one and one-half pints water. Polished sheet brass placed in the warm mixture will assume a steel blue color.

To Give Brass a Dull Finish

Mix one part (by weight) of iron rust one part white arsenic and twelve parts hydrochloric acid. Clean the brass thoroughly and apply with a brush until the desired color is obtained, after which it should be oiled, dried and lacquered.

RELAY RACK CONSTRUCTION

Rack and panel construction is a practice borrowed from a long established telephone practice. It offers many mechanical advantages, facilitates service and inspection and lends itself to the increasing association of radio apparatus with telephone equipment, besides enhancing the appearance of the apparatus.

Relay rack construction offers many advantages not to be found in other styles. Its appearance is commercial, parts are quite accessible and alterations which change the physical size of one section of the transmitter can be made without requiring corresponding

alterations in other sections, as would be the case with a frame-mounted or four-poster transmitter. The reason for this is that each section of the transmitter is provided with its own mounting unit, quickly removable after disconnecting supply wires. All the apparatus of the unit is supported by the panel.

The standard relay rack has two uprights made from three-inch 4.1-pound channel iron. The base is made from two pieces of 6 inch by 4 inch, $\frac{3}{8}$ " angle, and the top straps are made from two pieces of $\frac{1}{4}$ " by 2" cold-rolled iron. The

drawing gives all the details as well as dimensions necessary.

Panels are usually of metal (either steel, dural or aluminum) though sometimes made from pressed wood products such as "tempered masonite." Masonite is the cheapest, with steel, aluminum and dural next in order. The usual thickness of the metal panels is $3/16"$, and sometimes $1/4"$ is used. Metal panels of thinner dimensions are not satisfactory.

The versatility of the relay rack is due to the fact that dimensions have been completely standardized. A few manufacturers still use their own pet dimensions, but they are quickly falling into line. Panels are 19" wide and of varying heights. The height is measured as a rack unit, a rack unit being $1\frac{3}{4}$ inches. To allow for stacking and slight tolerance in cutting and fabrication, a relay rack panel is always made to be a certain number of rack units high less $1/32$ inch for clearance. This formula can be used:

$$\text{panel} = n(1\frac{3}{4}) - 1/32$$

Thus, a panel four rack units in height will measure 4 times $1\frac{3}{4}$ inches or 7 inches, less $1/32$ inch, or an exact total height of $6\frac{31}{32}$ inches. The channel uprights are drilled to take 10-32 round head machine screws as can be noted in the drawing. A very light tapped thread is sufficient, the usual 75% tap being unnecessary. Most of the strain on the thread is at right angles to the axis, and since this is shear on the screw, very little thrust is placed on the threads. A light thread takes less time and effort and results in fewer broken taps. When panels are properly made, the edge of a panel always falls midway between two holes spaced one-half inch apart.

Now to start your rack, go to the local steel company and order the following:

- 2 pieces 3-inch, 4.1-pound channel, $5'9\frac{1}{2}"$ long
- 2 pieces 6-inch by 4-inch by $\frac{3}{8}$ -inch angle, $1'8\frac{1}{2}"$ long
- 2 pieces $\frac{1}{4}$ -inch by 2-inch cold rolled, $1'8\frac{1}{2}"$ long

The total price on the above steel order, including the cutting, should be around \$5.00. Make sure that the steel is cut square and exactly to the above lengths. It is just as easy for the steel man to cut the right length and your rack will come out square and save you lots of tough filing. Ordinary strap iron

could have been used for the top straps, but the edges of this type of steel are not square and since this is such a small item, it is better to get the cold rolled for its square corners and finished appearance.

The steel will weigh within a pound or two of one hundred pounds. The next thing to do is to lay out the channels as shown in the drawing. Wipe off the steel and then chalk the front face of each channel. Use ordinary blackboard chalk. Remember that one member is left-handed and the other right-handed; *don't* make two right- or left-handed members.

Two tools are now needed: a center punch and one of the dime-store steel pushrules. Don't under any circumstances lay out the rack with an ordinary foot rule or yardstick. The cumulative error will show up and the rack will not be square. Note that the line of the holes is in $1\frac{1}{16}$ inch from the edge of the channel. Take a sharp pointed instrument and, using a scale set in a dividing head, mark this line (which will be the vertical line to the holes) carefully on the total length of the channel.

The top hole on each channel is $5/16$ inch below the top strap, or a total of $2\frac{5}{16}$ inches below the top of the rack. Carefully mark this top hole on each channel, keeping in mind that there is a right and left hand member. Now take the steel tape and clamp it to the channel with an even half-inch or inch mark exactly opposite the hole that has been center-punched $2\frac{5}{16}$ inches from the top. This first hole is the reference mark and all measurements are made from this point.

Now that the scale is clamped, go right down, first $1\frac{1}{4}$ inches and then one-half inch, alternating until 72 holes have been punched. If you have not made a mistake, the last hole will be exactly $4\frac{5}{16}$ inches from the bottom end of the channel. While punching the holes, check back frequently. It is very easy to make an incorrect reading on the scale and a single off hole will throw all the rest in the wrong place. After all the holes are center-punched, check back to see if the alternate $\frac{1}{2}$ -inch and $1\frac{1}{4}$ -inch spacings are correct. You cannot be too careful, as it is very easy to make a mistake here.

When all the holes are center-punched,

do the same on the back if desired. The frequent spacings are not necessary, but a few holes may prove handy. In any case two holes should be drilled and tapped about 5 inches above the bottom so that grounding and bonding wires can be fastened.

Next pilot-drill all the center punches. It is suggested that a small drill, number 28 or so, be used for this purpose. This operation consists of drilling the punch marks slightly so as to preserve the spacing and to give the tap drill a good bearing surface. The pilot holes need be drilled only until the maximum diameter of the drill is reached, which is about 1/16 inch deep.

When all the pilot holes are drilled, select the tap drill that will give the correct percentage of thread desired. For 10-32 thread of 75% clearance thread, a number 19 drill is correct. However, 75% thread is really unnecessary and several sizes larger can easily be used as explained before. For a drill press one can use a small mail-order house type which, with motor, costs about \$20. A good high-speed drill and a little oil make the drilling operation quite simple. Remember to set the channel so as to get the holes at right angles to the channel axis.

Tapping is next in order. Use a small hand tap-wrench, and above all things remember to get a *taper tap*. This type of tap is tapered and will easily go through without very much effort. Use plenty of thread cutting oil and take it easy. If you feel that you are getting tired, stop and come back to the job later. The least side twist on the wrench will break the tap.

After all the tapping is done, clean the burrs off the holes on the inside of the channel. This can easily be done with the head of a file.

The only other holes required are the base holes in the bottom angles. These are desirable, but not necessary. The

RELAY-RACK PANELS

1. Make panel height a multiple of $1\frac{1}{4}$ inches less $1/32$ inch for clearance.
2. Both top and bottom edges of a properly mounted panel will, neglecting clearances, always fall halfway between a pair of holes spaced $1/2$ inch apart on the rack.
3. It is seldom necessary to cut all the possible mounting-screw slots in a panel, but it can be done if desired.
4. Any panel laid out to fit the rack will also fit if the panel is turned end-for-end or back-for-front.

racks are self-supporting with most amateur radio equipment and do not need to be bolted to the floor. However, if it is felt the bottom holes are desirable, have some machine shop drill or punch the holes. The job is too tough for a small drill press.

Welding is the next operation. This is a difficult job and can best be done by an experienced welder. Take the pieces to him together with the drawing and show him just where the welding is to be done. There are eight welds altogether, and make sure that the welding is *not done where the panels will mount*. The rack should be set up on a welding table and checked several times for squareness. Before the welding tacks are made, check again the distance from the center of the bottom and top holes to the strap and the base. This must be exactly $5/16$ inch. If it is less, the panels will jam, and if it is more, an open space will show through.

A welder should not charge over \$4.00 for this welding job. Make the welder keep in mind that you want a finished job; it won't cost you any more provided you get him to set the price first!

After welding, the steel should be well cleaned and given a good coat of paint. Black is usually used, although black panels set against a rack painted with aluminum lacquer are quite striking.



CHAPTER 6

Learning the Code

License Requirements—The Code—Practice Sets

THE FOLLOWING is addressed to those who contemplate taking up amateur radio as a hobby. To secure an amateur license from the Federal Communications Commission, it is necessary that the applicant submit to an examination, the first part of which is a code transmitting and receiving test. The *Continental Code* is used for radio communication; it consists of combinations of dots and dashes. It differs from the *American Morse Code* in that the latter includes the use of spaces in addition to the dots and dashes in the formation of certain letters. Thus, for instance, the letter "r" in the *Morse Code* is *dot-space-dot-dot*. In the *Continental Code* the same letter is made as follows: *dot-dash-dot*. The *Morse Code* is used principally for land-line telegraphic communication in North America, while the *Continental Code* is used for both radio and ocean-cable communication.

The *Continental Code* is the more simple of the two because it uses only dots and dashes. The fact that the letters and numerals are free from spaces simplifies the learning of this code because one is less likely to interpret as two letters the characters intended as a single letter.

License Requirement

The applicant for an amateur license must be able to send and receive the *Continental Code* at a speed of 13 words per minute, with an average of 5 characters to the word. Thus, 65 characters must be copied consecutively without error in one minute. Similarly, 65 consecutive characters must be transmitted without error in that time. The appli-

cant, however, is given sufficient opportunity to pass this code test, since sending and receiving tests are both five minutes in length. If 65 consecutive characters, at the required rate, are copied correctly somewhere during the first five-minute period, the applicant may then attempt a transmission. Again, if 65 consecutive characters are sent correctly somewhere during this second period, a passing mark is received.

Mastering the code has been a stumbling block to perhaps 30 per cent of the total number of applicants who appear for amateur license examinations. The code test is given first at any of the several offices of the Federal Communications Commission; if the applicant passes it, he is permitted to proceed with the remaining portions of the examination (technical questions and radio laws). Failure to pass the code test results in a three-month rest period during which the applicant can improve his mastery of the code; thereafter, he may again appear for another try.

Memorizing the Sounds

The old line operators, who have graduated from the school of hard knocks, are almost unanimously of the opinion that the surest method of learning the code consists of becoming familiar with the combinations of short and long *sounds* that represent the dots and dashes needed to make up the various letters. The beginner is cautioned against regarding the code as being made up of dots and dashes, but rather as consisting of *sounds*, the dot sounding as a *did*, the dash as a *daw*.

The code, then, becomes a series of *dids* and *daws*, precisely as it sounds

when one listens in on a receiver of radio code signals. The code letter A, for example, is *not* dot-dash; it is *did-daw*.

Study the *code chart* for a few moments. Memorize the first three groups of characters which make up the letters A, B and C. Repeat these characters to yourself thus: *did-daw, daw-did-did-did, and daw-did-daw-did*. The three letters, A, B and C, are thus represented as they sound when heard on a code receiver.

Do not attempt to memorize too many letters of the alphabet at one time. Take a group of four, such as the letters E, I, S and H. These letters consist of nothing but *did*s (dots). E is *did*; I is *did-did*; S is *did-did-did*; H is *did-did-did-did*. On the other hand T, M and O are comprised solely of *daws* (dashes). T is *daw*; M is *daw-daw*, and O is *daw-daw-daw*.

Next memorize the letters which consist of combinations of dots and dashes, such as the letters N, U and W. N is *daw-did*; U is *did-did-daw*, and W is *did-daw-daw*. It is best to memorize one group of letters before proceeding to another group.

In sending, it is obvious that some space must exist between successive dots or dashes. The spacing is determined by the time necessary for the key to come up and then close again. No more time should be employed. To the ear, the letter A, previously denoted as *did-daw*, for the purpose of clarifying the use of the *did*s and *daws*, when this amount of spacing is used it should sound like *did-daw*. There is no pause between *did* and *daw*; they are completely run together

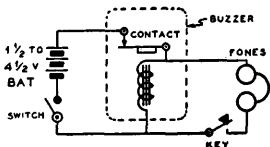

Figure 1. The simplest code practice set—a key, buzzer, battery and headphones. The buzzer operates continuously, but signals are heard in the headphones only when the key is depressed. This tends to keep the tone at a steadier pitch. For maximum battery and buzzer life, use as little voltage as possible.

THE RADIOTELEGRAPH CODE

A	•••••
B	•••••
C	•••••
D	•••••
E	•••••
F	•••••
G	•••••
H	•••••
I	•••••
J	•••••
K	•••••
L	•••••
M	•••••
N	•••••
O	•••••
P	•••••
Q	•••••
R	•••••
S	•••••
T	•••••
U	•••••
V	•••••
W	•••••
X	•••••
Y	•••••
Z	•••••

Numerals, Punctuation Marks, Etc.

•••••	1
•••••	2
•••••	3
•••••	4
•••••	5
•••••	6
•••••	7
•••••	8
•••••	9
•••••	0
•••••	INTERNATIONAL DISTRESS SIGNAL
•••••	PERIOD
•••••	COMMA
•••••	INTERROGATION
•••••	QUOTATION MARKS
•••••	EXCLAMATION
•••••	COLON
•••••	SEMICOLON
•••••	PARENTHESIS
•••••	FRACTION BAR
•••••	WAIT SIGN
•••••	DOUBLE DASH (BREAK)
•••••	ERROR (ERASE) SIGN
•••••	END OF MESSAGE
•••••	END OF TRANSMISSION

into one character. If these code elements were separated (*did daw*), the combination might easily be interpreted as consisting of two separate letters of the alphabet, since E is *did* and T is *daw*. (See code chart.)

Spaces, however, are inserted between the letters which comprise a single word and between the words themselves. To clarify this statement, a typical example is given at the bottom of the page.

Study the test group below. The *dids* and *daws* which comprise the various letters of the alphabet used in this sentence are printed over the letters. There is a short *space* between each letter and a *longer space* between each word. The space between *letters of a word* is equivalent to the length of time required to telegraph a single dash or three dots, whereas the space between *words* is equivalent to the length of time required to send *five dots*. Obviously, it is necessary that the spacing between the letters of a word be less than the spacing between the words themselves.

Many successful radio telegraphers have found it easier to learn the code as follows: First memorize a single letter of the alphabet, such as the letter A, *diddaw*. Firmly affixing this sound in your memory by continually repeating it, then tune a short-wave receiver until a slow-sending code transmitter is heard. Each time the *diddaw* is heard and recognized, it is written on a piece of paper. Another letter is then memorized, and the process of picking it out of some code transmission is again repeated. It is interesting to note the number of times the memorized letters can be heard and recognized. If this system is tried, pick the most used letters first.

Code Practice Sets

Another method of learning the code is with the aid of a code practice buzzer or oscillator, or by means of any one of

the several types of automatic code-sending machines which are commercially available. The latter can be adjusted so as to send the code at any desired speed.

A code oscillator is perhaps the most suitable device for the student. It consists of a vacuum tube, a conventional audio transformer, several small resistors and paper-type condensers, a telegraph key, a pair of headphones, a filament transformer and a B battery. Two vacuum tube oscillators are shown in the accompanying circuit diagrams, figures 2 and 3. Either is a satisfactory device. The oscillator shown in figure 2 uses a cathode-heater type tube and functions in what is known as a Hartley oscillating circuit. Tubes with either 2.5-volt or 6.3-volt heaters can be substituted with equal

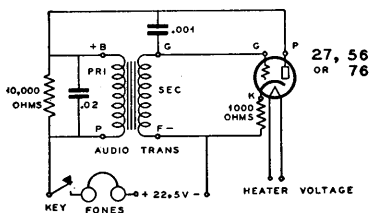
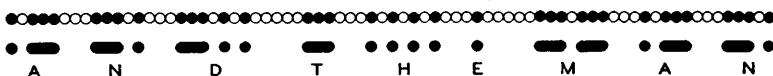

Figure 2. Code practice oscillator using heater tube. The tone can be varied by changing the values of condenser capacity.

success, providing the proper type of filament transformer for the particular tube is used.

The audio transformer can be of any commonly used turns ratio, the customary type having a ratio of one-to-three. The telegraph key is in series with the headphones and plate (p) terminal of the audio transformer. The pitch of the note can be varied by merely increasing or decreasing the B voltage.

The capacity of the two fixed condensers shown in the diagram in figure 2 also will have an effect on the resultant



DASH EQUAL TO THREE DOTS.
SPACING BETWEEN LETTERS EQUAL TO ONE DASH.
SPACING BETWEEN WORDS EQUAL TO FIVE DOTS.

tone from the oscillator; almost any desired tone can be secured by changing these values though those shown in the circuit diagram have proven generally satisfactory.

This vacuum tube code practice oscillator is far more practical than the simple buzzer device shown in figure 1 because it emits a more stable tone which can be varied to suit the taste of the individual.

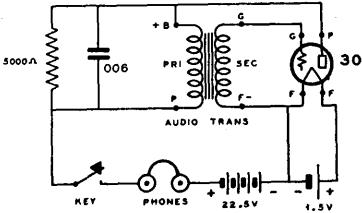

Figure 3. Code practice oscillator using triode filament-type tube. Equally desirable as the method shown in figure 2.

Neon Bulb Oscillators

A highly effective and simple code practice oscillator can be had by hooking up a neon bulb in a relaxation oscillator circuit. A common, two-watt neon or argon lamp, which can be purchased at any electric shop, forms the heart of the system. The resulting note falls far short of being a sine wave, but is actually more pleasant to listen to for long periods of time due to the presence of melodious overtones. Two methods of applying the relaxation oscillator principle are shown: in figure 6 is shown a simple oscillator which requires only 90 volts of B battery for operation, while in figure 7 is pictured a method of utilizing your present receiver as a code practice oscillator.

Some lamps will be found better oscillators than others, because of lack of uniformity in manufacture. On the whole, the argon type lamps will oscillate more readily than the neon ones.

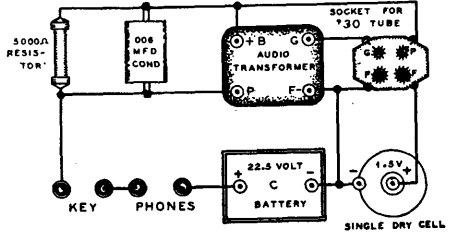

Figure 4. Pictorial wiring diagram of code practice oscillator shown schematically in figure 3.

The lamps look alike when not lighted, but when lit are distinguishable because the neon lamps have an orange-red glow and the argon lamps produce a violet glow. Occasionally, a lamp will be found which will light but will not oscillate with the constants and potential shown in figure 6. In this case, the value of R_2 should be increased in small steps until oscillation is obtained. If the lamp goes out before oscillation is obtained, a higher source of voltage or another bulb should be tried.

The bulbs have a small resistor built into the base. The bulbs should be used

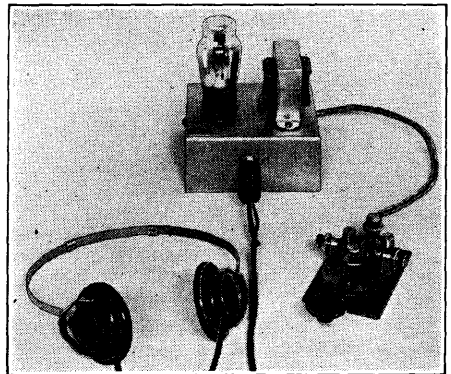
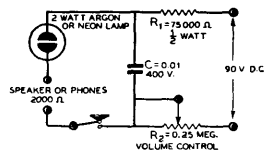

Figure 5. Code practice ensemble consisting of vacuum tube oscillator, telegraph key and headphones, as shown in figures 2 and 3.

Figure 6. An excellent code practice oscillator can be made by utilizing a neon or argon lamp in a relaxation oscillator circuit as shown at right. If difficulty is experienced in obtaining oscillation, another lamp should be tried. This oscillator delivers a pleasing musical note and draws but very little current from the battery.



as is; the resistor should not be removed.

The current drain of the oscillator of figure 6 is so low that the small portable type 45-volt batteries will last indefinitely.

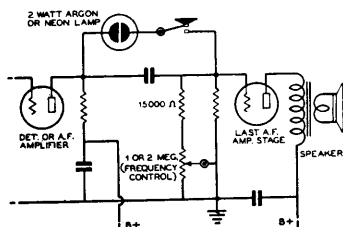

Figure 7. A 2-watt gaseous lamp, a 15,000-ohm carbon resistor, a 1-megohm potentiometer and a telegraph key are the only items required to convert your receiver into a code practice oscillator. The diagram assumes that your receiver uses conventional resistance coupling to the last audio stage.

The Successful Telegrapher

Each telegrapher acquires what is known as a fist, i. e., his own individual style of sending on a telegraph key either of the hand type or the automatic variety. The latter key is known as a bug, speed key or automatic key and should not be employed by the beginner until he has become thoroughly adept in sending the code by means of a standard hand type key.

Proper adjustment of a hand type key is as important as its actual use. It is advisable that beginners have the telegraph key adjusted by an experienced amateur or other telegraph operator. The feel of the key is all important. It determines to a large extent the nature of the characters which the operator is sending. If the key is opened too wide the sending will be choppy; if not opened sufficiently wide, the sending will sound sloppy. Neither is desired, nor to be tolerated. The key should be so adjusted that the spacing between its contact when ready for use, is approximately 1/16-inch.

The telegraph key should be firmly secured to the operating table or mounted on a board. The tension of the spring on the lever of the key should be adjusted so that no effort is encountered in depressing the key. If the spring is made too stiff in adjustment, the operator will

soon tire his hand; however the tension must be sufficient in order that the key will snap back instantly when released.

To use a telegraph key properly, one's arm should rest on the table in the manner shown in the accompanying sketch. The third and index fingers are placed on the flat portion of the knob of the key, the thumb being permitted to touch gently the *side* of the knob in such a position that it literally floats. This is much preferred to placing the thumb securely under the key knob.

The wrist must be permitted to move freely in an upward-and-downward motion, with the arm comfortably at ease on the table, and the third and index fingers lightly resting atop the key knob, the thumb floating at the side of the knob as indicated above. Do not grasp the key as though it were ready to walk off the table. *Grasp it gently*, making no effort of the task of handling the key.

With the *Code Chart* on the table near the telegraph key, turn on the code prac-

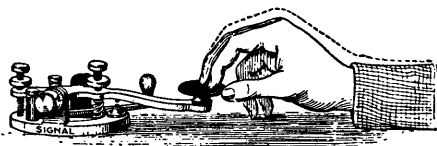

Correct position for arm and wrist, showing how third and forefinger and thumb are placed on key knob.

tice set and send a few preliminary *did*s and *daw*s to get the feel of the key. Then send the letter A on the key. Send *did-daw*, letting the combination roll into itself. Remember never to send it as *did daw* with a noticeable space between the *did* and the *daw*. Learn the knack of rolling the characters into one another. This is what is known as smooth sending. You will not succeed in mastering this technique if the tension of the key is too great or if the contacts are spaced too far. Continue to practice sending the letter A until you have full control of the touch of the key, and until you can send this letter over and again without error. Send *diddaw*, then a short pause, then another *diddaw*, and repeat the process with a slight pause following each *diddaw*.

Send cautiously, steadily, so that you can distinguish every character you make upon the key. Do not try to send fast at first. If you cannot distinguish the

characters while you are sending them, how could it be expected of another to copy what you are sending? *Too many students make the mistake of attempting to send faster than they can receive.*

When you have succeeded in sending the entire code from A to Z without error, making sure that you have paused between each letter of the alphabet, continue your practice by sending words, then complete sentences. A slight pause should exist between each of the letters making up a word, then a longer pause between the words in the sentence. Therein lies the secret of good clean telegraphing.

It is advisable to attempt to interest a friend in practicing the code with you. However, first acquaint yourself with the characters of each letter of the alphabet, without assistance from others, so that you can send them upon the key without reference to the code chart. Attempt to relax when sending or receiving. Calmly make the characters in an effortless manner. When receiving, relax in your chair.

If someone is sending to you on a practice set, write down the characters as you intercept them. If a letter is sent which you do not instantly recognize from memory, ask the sending operator to break, or pause, until you have recalled the character from memory, or ask the operator to repeat the character until you have recalled it. If this fails, refer back to the code chart to determine it. Do not permit a letter to skip by. It is better either to pause or to ask for a repeat because by this means the hard-to-learn combinations will be more quick-

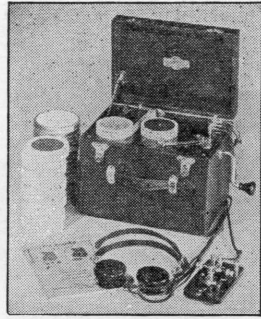

A typical automatic code-practice ensemble.

ly mastered.

The method of learning the code advocated here has become known as the *sound system* by reason of the fact that the characters are memorized in the form of sounds (dids and daws) and not as dots and dashes. Repeat these dids and daws to yourself throughout the day or in your spare moments.

Hum signs conveniently located nearby; send familiar phrases and sentences

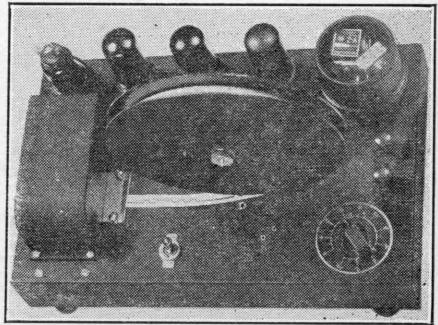

An automatic code transmitter utilizing a photoelectric cell.

E	•	T	—
I	••	M	— —
S	•••	O	— — —
H	••••	CH	— — — —
5	•••••	Ø	— — — — —
A	• —	N	— •
U	• • —	G	— — •
V	• • • —		
4	• • • • —	9	— — — — •

Dots alone, dashes alone and combinations of dots and dashes are found in the code groups above. These are the more easily memorized combinations in the radiotelegraph code.

by means of your tongue. It will surprise you to realize how quickly and easily you can learn the entire code by thus utilizing spare moments.

Proper spacing of letters and words is even more complex than that of learning the code itself and of the utmost importance in the training of a good telegrapher. For this reason, it is well to memorize such difficult combinations as those which are made up entirely of dashes. The sentence: *Tom To Otto*, for example, consists of nothing but dashes with spacing between the letters and words. Another group, *She Is His*, consists entirely of dots with proper spacing

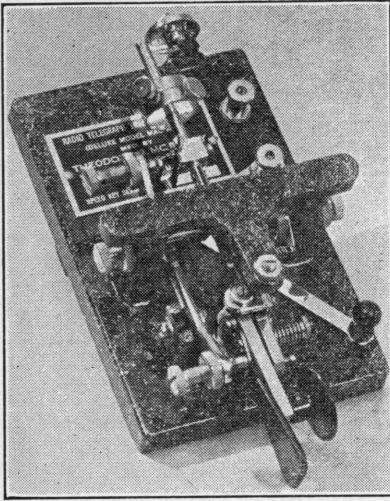

This "bug" key sends dots automatically.

between letters and words. The paramount considerations for clean-cut telegraphing are repeated and summarized as follows:

- (1) The key contacts should be spaced no more than $1/16$ inch.
- (2) The tension of the spring on the key should be quite light.
- (3) Send slowly until you have mastered the code, then improve your speed.
- (4) A dot is made with one rapid depression of the key.
- (5) A dash should be approximately three times as long as a dot.
- (6) Roll the characters of a single letter together, with no pause between them.
- (7) Pause slightly between letters of a word. (Approximately one dash.)
- (8) Pause a bit longer between words. (Approximately five dots.)



CHAPTER 7

Radio Receiver Theory

Autodyne, T.R.F. and Superheterodyne Action—A.V.C., A.F.C. and Noise Circuit Operation—Testing, Alignment

THE RADIO RECEIVER must abstract energy from passing radio waves, separate the desired signal from all others and then reproduce the modulation or code characters of the original signals. This latter function of the receiver usually entails amplification, since its output must be enormously greater than the energy obtained from the wave itself.

The antenna circuit plays an important part in this reception. Details of the antenna's function, however, are covered in another portion of this book. For the present, suffice it to say that making the antenna resonant to a particular frequency will also increase tremendously the energy received from waves of this frequency. This, in itself, assists in providing some separation between signals. Greater selectivity, however, can be made available by the use of properly arranged resonant circuits placed in the receiver in such a way as to discriminate strongly against all but the desired signal.

Common Terms Defined

There are several important general properties of radio receivers which it is necessary to define: *selectivity*, *tuning*, *detection*, *sensitivity* and *fidelity*.

Selectivity of the receiver is its ability to discriminate between radio waves of different frequencies, between desired and undesired signals.

Tuning is the process of resonating r.f. circuits with the carrier frequency of a desired signal.

Detection is the process of reproducing the original signal from the radio-frequency currents existing at the receiver; it is the process of *demodulation*.

The *sensitivity* of the receiver represents its ability to respond to small radio-signal voltages; it is the degree to which a receiver will respond to weak signals.

The *fidelity* of the receiver represents the accuracy with which the receiver reproduces the intelligence contained in the modulated radio wave; frequency distortion and harmonic distortion impair the fidelity.

Basic Components

The fundamental parts of a simple radio receiver are the vacuum tube and the coupling circuits. The tube provides *amplification* and *detection*, while the r.f. coupling circuits provide the *selectivity* and determine the frequency at which the receiver will operate. Other coupling circuits in the receiver are used for supplying power to the electrodes of the vacuum tube and also for coupling the audio-frequency amplifiers if used.

Radio-Frequency Coupling

Radio-frequency current is induced in an antenna by any radio wave which is intercepted by the antenna. This minute radio-frequency energy in the antenna can be made to energize a radio receiver by means of some form of *input coupling circuit*. When an inductance coil is connected in series with the antenna lead-in or feeder, the radio-frequency energy induced into the antenna will cause a small radio-frequency current to flow through coil L₁ in figure 1.

It will be recalled that the voltage induced across the coil is equal to the product of this current and the impedance of the coil. The *impedance* of the

CHAPTER 7

Radio Receiver Theory

Autodyne, T.R.F. and Superheterodyne Action—A.V.C., A.F.C. and Noise Circuit Operation—Testing, Alignment

THE RADIO RECEIVER must abstract energy from passing radio waves, separate the desired signal from all others and then reproduce the modulation or code characters of the original signals. This latter function of the receiver usually entails amplification, since its output must be enormously greater than the energy obtained from the wave itself.

The antenna circuit plays an important part in this reception. Details of the antenna's function, however, are covered in another portion of this book. For the present, suffice it to say that making the antenna resonant to a particular frequency will also increase tremendously the energy received from waves of this frequency. This, in itself, assists in providing some separation between signals. Greater selectivity, however, can be made available by the use of properly arranged resonant circuits placed in the receiver in such a way as to discriminate strongly against all but the desired signal.

Common Terms Defined

There are several important general properties of radio receivers which it is necessary to define: *selectivity*, *tuning*, *detection*, *sensitivity* and *fidelity*.

Selectivity of the receiver is its ability to discriminate between radio waves of different frequencies, between desired and undesired signals.

Tuning is the process of resonating r.f. circuits with the carrier frequency of a desired signal.

Detection is the process of reproducing the original signal from the radio-frequency currents existing at the receiver; it is the process of *demodulation*.

The *sensitivity* of the receiver represents its ability to respond to small radio-signal voltages; it is the degree to which a receiver will respond to weak signals.

The *fidelity* of the receiver represents the accuracy with which the receiver reproduces the intelligence contained in the modulated radio wave; frequency distortion and harmonic distortion impair the fidelity.

Basic Components

The fundamental parts of a simple radio receiver are the vacuum tube and the coupling circuits. The tube provides *amplification* and *detection*, while the r.f. coupling circuits provide the *selectivity* and determine the frequency at which the receiver will operate. Other coupling circuits in the receiver are used for supplying power to the electrodes of the vacuum tube and also for coupling the audio-frequency amplifiers if used.

Radio-Frequency Coupling

Radio-frequency current is induced in an antenna by any radio wave which is intercepted by the antenna. This minute radio-frequency energy in the antenna can be made to energize a radio receiver by means of some form of *input coupling circuit*. When an inductance coil is connected in series with the antenna lead-in or feeder, the radio-frequency energy induced into the antenna will cause a small radio-frequency current to flow through coil L_1 in figure 1.

It will be recalled that the voltage induced across the coil is equal to the product of this current and the impedance of the coil. The *impedance* of the

coil to the flow of current is made up principally of its *reactance*. This is a function of the coil dimensions and the frequency of the radio signal.

Ordinarily the antenna, ground and coil L_1 offer very little *selectivity*, which is always better obtained by means of resonant tuned circuits. As has been mentioned previously, the entire antenna system may be made resonant to the frequency of the radio signal, in which case the current flowing in the antenna circuit will be much greater.

For the purpose of simplicity, the standard circuit in figure 1 will be considered, in which resonant effects in the antenna usually are ignored. Selectivity is accomplished through the use of *parallel tuned circuits*. A typical circuit of this type is shown as L_2 and C . The current flowing through L_1 induces a current into L_2 , providing the two coils L_1 and L_2 are coupled closely together. This is known as *inductive coupling*.

The antenna also may be coupled to the first tuned circuit in the radio receiver by means of capacitive coupling as shown in figure 2.

The capacity of condenser C_1 is very small, so that the desired amount of coupling between the antenna and the tuned circuit $L-C_2$ can be obtained. Too much coupling between the antenna and the first tuned circuit will result in less induced current flowing through the tuned circuit than when the optimum value of coupling is used. If the antenna circuit is *resonant* to the frequency of the radio signal, and if the grid circuit is tuned to this same frequency, very loose coupling is necessary in order to obtain both a high current in the coil

and a high impedance across the tuned circuit.

The current which flows around and through the tuned circuit is limited only by the resistance of the circuit when the coil and condenser are tuned to resonance. The reactance of the coil is neutralized by the reactance of the condenser, so that relatively greater current may flow in the circuit L_2-C than in the coil L_1 . The voltage developed at resonance across the coil or condenser is equal to the product of this current and the reactance of *either* the coil or condenser.

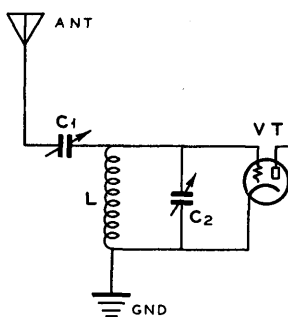

Figure 2. Illustrating capacitive coupling between an antenna and input circuit of a receiver. If C_1 is made large enough that the reactance is low at the operating frequency, the coupling may be considered as direct or conductive.

Since resonance increases the radio-frequency current (the reactance of the coil remaining the same), the voltage applied across the grid circuit of the vacuum tube is much greater at the resonant frequency. Signals of other frequencies will not have this resonant tuned circuit effect, with the result that the voltage of those signals across the coil applied to the grid of the vacuum tube will be very minute. Additional tuned circuits in the radio receiver further discriminate against these undesired signals of other frequencies.

Advantages of Resonant Circuits

The efficiency of a tuned circuit can be defined as its Q . This is a mathematical expression of the ratio of the

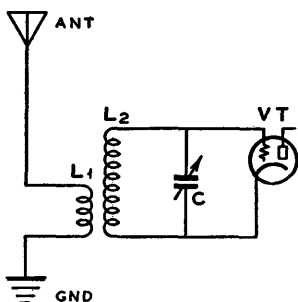

Figure 1. Illustrating inductive type radio-frequency coupling between an antenna and input circuit of a receiver.

reactance to the resistance of the coil. A high Q will result in better selectivity and greater radio-frequency voltage at the grid of the vacuum tube. Low Q coils are sometimes desirable where a relatively wide band of radio frequencies must be passed through the radio-frequency amplifier, such as in modern types of high-fidelity broadcast receivers. Short-wave receivers are designed with circuits having as high a Q as possible or economically practicable.

The Q of a coil or tuned circuit is given in the following formulas:

$$(1) \quad Q = \frac{2\pi fL}{R}$$

$$(2) \quad Q = \frac{1}{2\pi fCR}$$

where f is the frequency,
 L is the inductance of the coil,
 C is the capacity of the tuned circuit,
 R is the equivalent resistance in series with the tuned circuit.

Either of these expressions will provide the correct Q , since at resonance

$$X_c = X_L \text{ and } 2\pi fL = \frac{1}{2\pi fC}$$

The value of R varies with the amount of coupling between the antenna and tuned circuit, or between the plate circuit of a vacuum tube and the succeeding tuned circuit; in either case, the effect is to increase the total resistance R when the coupling is increased. The resistance of the tuning condenser is lower than that of the coil, or inductance, so that special care should be exercised in designing this coil. Whenever possible, the shape of the coil should be such that its length is made equal to its diameter; this will provide a high Q . The diameter of the wire and the spacing between turns also has a definite influence on the Q .

At radio frequencies, most of the resistance of the inductance coil is due to *skin effect*. This effect increases with the frequency and becomes significant at high frequencies because the current then is not equally distributed throughout the conductor. Instead, it tends to travel only on the outermost surface of

the wire. For this reason, the radio-frequency resistance may be a great many times higher than the resistance which the wire would offer to direct current.

Providing an air space between turns on the coil, reduces the *distributed capacity* between turns and also increases the Q . Dielectric losses in the insulating material and coil forms also have an important effect on the efficiency of the coil. The proximity of other objects, such as *metal shields* or chassis, appreciably reduces the Q of the coil, unless the distance between the coil and the shielding is at least equal to the diameter of the coil from its side, and twice this distance from the ends of the coil. The wire with which the coil is wound is a compromise between several factors, such as the size of the wire, its cost, allowable physical size of the coil, distributed capacity between turns and skin effect.

The variable tuning condensers in radio receivers are designed to have as low a minimum capacity as possible, in comparison with the capacity when the plates are fully meshed. The maximum capacity of the tuning condenser varies from 10 micromicrofarads up to approximately 370 micromicrofarads in the various types of radio receivers; still larger values are used in some long-wave receivers. *All-wave* radio receivers, which cover short wave as well as broadcast wavelengths, generally use rather large tuning condensers, thereby crowding the tuning on the short wavelengths. Very small tuning condensers are desirable for short-wave receivers so that tuning of the receiver to the desired station is made more easy and the Q of the high-frequency resonant circuits is kept high.

Bandsread Tuning

Short-wave signals are difficult to tune when the receiver has large tuning condensers, unless some method is used to slow down the rotation of the condenser with respect to the tuning band, either mechanically or electrically. This process is known as *bandspreading*. Most short-wave stations of a particular type operate in relatively narrow bands in the short-wave spectrum and these narrow bands should be spread out by the tuning device of the receiver.

Mechanical bandspreading often consists of a two-speed dial arrangement attached to a large tuning condenser. One control on the dial operates the tuning condenser at a very slow speed, and sometimes this control is geared to an additional pointer in order to facilitate tuning in the short-wave bands. There is a practical limit to the amount of mechanical reduction in the drive of a vernier dial before backlash develops, which makes tuning difficult.

Electrical bandspreading is accomplished in a number of ways, as shown in figures 3, 4, 5 and 6. The principle is to connect an additional tuning condenser of very small capacity across the larger tuning condenser so that equal rotations of the two condensers will cover vastly different portions of the short-wave band. The large condenser is for rough tuning or band setting, the small condenser for fine or vernier tuning.

A typical system of this type is shown in figure 3, in which the large tuning condenser C_1 may have a maximum capacity of any value from 100 $\mu\text{fd.}$ to 370 $\mu\text{fd.}$ The small vernier tuning condenser C_2 may have any value from 10 $\mu\text{fd.}$ to 50 $\mu\text{fd.}$, depending upon the particular design of the receiver. In some circuits, the small condenser C_2 is made semivariable by means of a screw-driver adjustment, in which case it is used only for the purpose of aligning several tuned circuits for single dial control.

The circuit in figure 4 is similar in action to that in figure 3 and has certain advantages except from the standpoint of cost. Condenser C_3 is the usual large tuning condenser and two additional smaller tuning condensers, C_1 and C_2 , are connected in series and across the large condenser C_3 . If C_2 and C_3 are mechanically ganged together, the relative amount of bandspread tuning of C_1 can be made the same over the complete range of C_3 . If condenser C_2 in figure 3 has a fairly high capacity, such as 350 $\mu\text{fd.}$, the band which can be covered by C_1 will only be a fraction as wide at the higher capacity values of C_2 as compared with its lower values. Figure 4 overcomes this disadvantage.

Figure 5 shows a bandspread method which is often used when condensers C_1 and C_2 both have a maximum capacity of say 100 $\mu\text{fd.}$ Bandspreading is accomplished by means of C_1 , which

is connected across a small portion of the tuned circuit. The advantage of this method is that the location of the tap on the coil can be changed for the various coils which cover the different bands, with the result that fairly constant bandspread is accomplished in each coil range. The disadvantage lies in the effect produced by connecting C_1 across a portion of the coil in the r.f. circuit of a superheterodyne receiver; the effect is to cause *image interference* and *cross modulation* to be more pronounced in this type of circuit, and makes necessary the use of additional tuned circuits.

In figure 6 is illustrated another method of equalizing the degree of bandspread over a wide range of frequencies. C_1 is the large 350- $\mu\text{fd.}$ tuning condenser; two bandspread condensers C_2 and C_3 , of 50 $\mu\text{fd.}$ and 15 $\mu\text{fd.}$ respectively, are switched across the large tuning condenser for bandspreading the short-wave bands. The 50- $\mu\text{fd.}$ condenser is suitable for bandspread tuning in the range from 75 to 200 meters, and the smaller condenser is suitable from 10 to 75 meters. The disadvantage of this circuit lies in the switching ar-

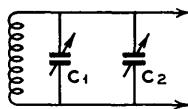

FIG. 3

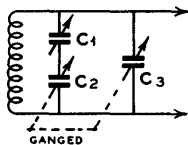

FIG. 4

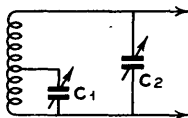

FIG. 5

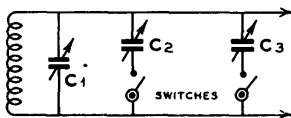

FIG. 6

ELECTRICAL BANDSPREADING.

rangement, which may require relatively long connecting leads; the minimum capacity of the circuit would then be rather high, and the lumped inductance low at the higher frequencies.

Tuned R. F. Circuits

The foregoing was devoted primarily to tuned circuits. A radio-frequency amplifier tube can be connected between these tuned circuits in order to increase the *sensitivity* of the receiver. The amplification derived from the vacuum tube depends upon the type of circuit in which it is used; if the plate load impedance can be made very high, the gain may be as much as 200 or 300 times that of the signal impressed across the grid circuit. Normal values of gain in the broadcast band are in the vicinity of 100 times. A gain of 30 per r.f. stage is considered excellent for short-wave receivers which have a range of from 30 to 100 meters. Radio-frequency amplifiers for the very short wavelengths, such as from 5 to 20 meters, seldom provide a gain of more than 10 times because of the difficulty in obtaining high load impedances, and the shunt effect of the rather high input capacities of most screen-grid tubes.

A simple r.f. amplifier and regenerative detector circuit is shown in figure 7. The two L-C circuits are tuned to the same frequency throughout the tuning range of each set of coils. This requires that the coils L_2 and L_3 have equal values of inductance, as well as equal values of shunt capacity at each point on the tuning dial. The coils can be matched closely by winding the same number of turns of wire on similar coil forms, with the same length of winding space for each coil. Condensers C_2 and C_3 are generally called *padder condensers*,

or *bandsetting condensers*, depending upon their maximum capacity.

In certain receiver designs, the ganged condensers C_1 and C_4 are used for tuning over the desired range, and C_2 and C_3 are small mica or air dielectric trimmer condensers aligning the two tuned circuits at the high-frequency end of the tuning range. The miscellaneous circuit capacities are not the same for a detector and r.f. amplifier, so that some additional capacities such as padder condensers are needed to align the receiver properly. A resonant antenna will unbalance the r.f. stage unless L_1 is loosely coupled to L_2 . Coil L_2 and condenser C_2 are closely coupled to L_3 , and are sometimes used to simulate the effect of both L_1 and the output capacity of the screen-grid r.f. tube.

Autodyne Detector

Most tuned-radio-frequency receivers have a regenerative *autodyne detector*, similar to the one shown in figure 7. More than one stage of r.f. amplification can be used ahead of the detector in some circuits. *Regeneration* can be obtained in a number of ways, such as with a *tickler* in the plate or screen-grid circuits of the detector, or by means of a *tap* in the tuned grid circuit to which the cathode of the detector tube is connected. In the latter case, the screen-grid must be bypassed to the chassis ground connection; the screen-grid voltage is then varied to control the regeneration to the point of oscillation.

Regeneration is introduced by feeding back a small portion of the amplified r.f. voltage in the plate or screen circuit of the detector tube; this r.f. energy is fed back into the tuned grid circuit so that it will aid the impressed signal. If the amount of feedback is sufficiently high, the tube will break into oscillation; heterodyne reception may then be used for receiving c.w. telegraph signals. As shown in figure 7, the *tickler* portion consists of that part of the coil L_3 which is between the ground and cathode connections. A better name for *tickler* is *feed-back coil*.

The purpose of the detector is to convert the radio-frequency signal into an intelligible audio-frequency signal which can be detected by the human ear. Audio-frequency amplifiers increase the audio-frequency energy to any desired output

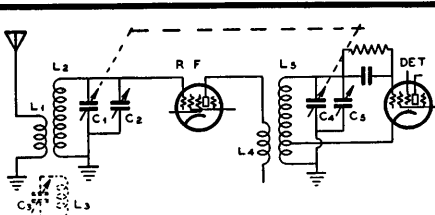

Figure 7. R. F. amplifier and regenerative detector circuit.

for headphone or loudspeaker reception.

The simplest receivers have no r.f. amplification; the antenna feeds directly into the autodyne detector.

Regenerative R. F. Amplifiers

Radio-frequency amplifiers for wavelengths down to 30 meters can be made to operate efficiently in a nonregenerative condition. Amplification and selectivity are ample over this range. For higher frequencies, on the other hand (wavelengths below 30 meters), *controlled regeneration* in the r.f. amplifier is often desirable for the purpose of increasing the gain and selectivity.

The input impedance of the grid circuit of a radio-frequency amplifier consists of a very high capacitive reactance which becomes part of the tuning capacity for longer wavelengths. However, in very short wave receivers the input reactance of a screen-grid tube may drop to very low values, such as a few thousand ohms. The input impedance then drops to such a low value that very little amplification can be secured from the complete r.f. amplifier stage.

A small amount of r.f. feedback can be introduced to compensate for this tube loss. Regeneration can be carried to the point of actually creating the effect of negative resistance in the tuned circuit, and thereby balancing the resistance introduced in series with the tuned circuit of the relatively low parallel tube resistance. Excessive regeneration will result in too much negative resistance, which will cause the r.f. amplifier to oscillate. Operation should always be below the point of self-oscillation.

A minor disadvantage of the regenerative r.f. amplifier is the need for an additional regeneration control, and the difficulty of aligning this circuit with the following tuned r.f. stages. Resonant effects of antenna systems usually must be taken into account; a variable antenna coupling device can be used to compensate for this effect. Another disadvantage is the increase in hiss, or internal noise, in the r.f. amplifier.

The reason for using regeneration at the higher frequencies and not at the medium and low frequencies can be explained as follows: The signal to noise ratio (output signal) of the average

superheterodyne receiver is improved by incorporating considerable r.f. amplification ahead of the first detector or mixing circuit. At the very high frequencies, it is very difficult to get appreciable gain at the signal frequency without resorting to regeneration; hence regeneration is used in spite of the fact that the signal to noise ratio of the *r.f. amplifier itself* is not quite so good with regenera-

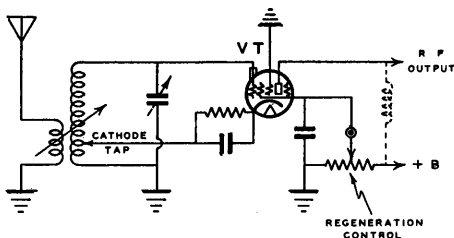

REGENERATIVE R F AMPLIFIER

FIGURE 8.

tion due to the introduction of regeneration hiss.

While the signal to noise ratio of the r.f. amplifier is reduced slightly by the incorporation of regeneration, the signal to noise ratio of the *receiver as a whole* is improved at the very high frequencies because of the extra gain provided ahead of the first detector, this extra gain tending to knock down the conversion and thermal agitation hiss in the first detector and the i.f. amplifier stages by allowing one to run them at reduced gain for a given receiver output.

Circuit Capacities

Several capacities are involved in most tuned circuits in a receiver. These are the tuning condenser capacity, tube capacity, trimmer condenser capacity, coil distributed capacity and miscellaneous capacities due to wiring and placement of parts. These capacities all combine to increase the apparent capacity of the tuning condenser, thereby limiting the obtainable minimum capacity at the high-frequency tuning portion of the circuit. A high minimum capacity reduces the ratio of maximum to minimum tuning capacity, which results in a narrower tuning range for a tuning con-

denser of a given size. High minimum capacity is also objectionable in very short-wave reception because the average ratio of capacity to inductance becomes too high for efficient reception.

In multistage tuned circuits, trimmer condensers are necessary in order to align the circuits properly for single-dial control. The trimmer condensers are adjusted at the high-frequency end of the band under test. Slight variations of inductance are often compensated for by slightly bending the end plate on the rotor of each section of the main tuning condenser. Sometimes this plate is slotted in order that it can be more easily bent in or out. The so-called secondaries of the tuned coils are often made to have the same value of inductance by matching them on some form of coil or inductance matching bridge before the coils are placed into the receiver.

Types of Receivers

Numerous kinds of radio receivers are used for short-wave reception:

- (1) *Regenerative Detector*
- (2) *Regenerative Detector and Audio Amplifier*
- (3) *T.R.F. Receiver*
- (4) *Superregenerative Receiver*
- (5) *Superheterodyne Receiver*

A *regenerative detector* consists of any triode or screen-grid tube in conjunction with a single tuned circuit, and some means for obtaining regeneration, as mentioned in previous discussions.

The addition of an audio amplifier to a regenerative detector increases the strength of the signal and also the apparent sensitivity, the latter, however, only to the extent that the signal may be more easily heard; an audio amplifier ordinarily will not increase the sensitivity to very weak signals that are masked by noise or regeneration hiss. Audio amplifiers are coupled to the output of a detector by means of resistance coupling, impedance coupling or transformer coupling.

T.R.F. receivers have one or more stages of radio-frequency amplification ahead of the detector and audio amplifier. These receivers are more sensitive to weak signals and have somewhat better selectivity than the two previously mentioned types.

The *superregenerative receiver* is similar in action to a regenerative receiver, except that the regeneration is carried to a far greater extent by permitting the tube to break into oscillation. Then, by means of an additional low-frequency oscillation, the detector is made to break in and out of signal-frequency oscillation at the frequency of the low-frequency oscillation. Superregeneration is used on very short wavelengths, such as in the micro wave and ultra-high-frequency regions.

The *superheterodyne receiver* consists of a radio-frequency circuit (or circuits) tuned to the frequency of the desired signal, and also an additional amplifier which is generally tuned permanently to some low frequency, such as 465 kilocycles. The incoming radio-frequency signal is converted into the new *intermediate frequency* by means of a *high-frequency oscillator* and *first detector* or *mixer* circuit. The additional amplifier, consisting of one or more intermediate frequency stages, can be made very selective, with the result that this type of receiver is much more selective than any of the previously mentioned types.

The *superheterodyne receiver* requires a *second detector* to convert the intermediate signal into an audio signal, just as in the case of the simple regenerative detector receiver.

Vacuum Tubes for Receiving

There are dozens of different types of tubes for use in radio receivers. Many similar tubes are made in different forms, such as metal tubes, glass tubes with standard bases, glass tubes with octal bases similar to those used on metal tubes, glass tubes encased in metal shells and fitted with octal bases and tubes with similar characteristics but differing in their heater or filament voltage and current ratings. Some tubes are designed for dry-battery filament supply, others for automobile service and another group for operation from an a.c. source.

In general, there are certain distinct classes of tubes for particular purposes. Screen-grid tubes were primarily designed for radio-frequency amplifiers, yet they are often employed for regenerative detectors, mixers and high-gain voltage audio amplifiers. General purpose triode tubes are designed for oscillators, detectors and audio amplifiers. Power

triodes, tetrodes and pentodes are designed for obtaining as much power output as possible in the output audio amplifier stage of a radio receiver. Diodes are designed for power supply rectifiers, radio detectors, automatic volume control circuits and noise suppression circuits. In addition to these general types of tubes, there are a great many others designed for some particular service, such as oscillator-mixer operation in a super-heterodyne receiver.

All vacuum tubes require a source of power for the filament and other electrodes. Various components in a radio receiver are for the purpose of supplying direct current energy to the electrodes of the tubes, such as the plate and screen circuits. In nearly all circuits, the control grid of the vacuum tube is biased negatively, with respect to the cathode, for proper amplifier action. This bias is obtained in several ways, such as from a self-biasing resistor in series with the cathode, fixed bias from the power supply or grid leak bias for some oscillators and detectors.

Various by-pass and coupling condensers are found in different portions of the circuits throughout a radio receiver. By-pass condensers provide a low impedance for r.f. or audio frequencies around such components as resistors and choke coils. Coupling condensers provide a means of connection between plate and grid circuits in which the d.c. voltage components are of widely different values. The coupling condenser offers an infinite impedance to the d.c. voltages, and a relatively low impedance to the r.f. or a.f. voltages.

Screen-grid tubes have a higher plate impedance than triodes and, therefore, require a much higher value of plate load impedance in order to obtain the greatest possible amount of amplification in the audio or radio circuits. Screen-grid tubes are normally used in all r.f. and i.f. amplifiers because the control grid is electrostatically screened from the plate circuit. Lack of this screening would cause self-oscillation in the amplifier; when triodes are used in amplifiers, the grid-to-plate capacities must be neutralized. The r.f. amplification from a triode amplifier in a radio receiver is so much less than can be obtained from a screen-grid tube amplifier that triodes are no longer used for this purpose.

Reference should be made to the chapter on *Vacuum Tubes* for data on all types of tubes. Practical applications of various types are shown in the receivers described in the succeeding chapter of this *Handbook*.

Automatic Volume Control

An elementary circuit of an automatic volume control system is shown in figure 9. A diode tube is used as a rectifier of the carrier signal. The radio- (or intermediate) frequency circuit to the diode is completed through the small condenser C_1 , which is too low in value to by-pass audio frequencies. The carrier signal is detected or rectified, and the resulting current flows through the diode circuit and the resistance R_1 . This rectified current develops a voltage across R_1 , which is more negative at the ungrounded end.

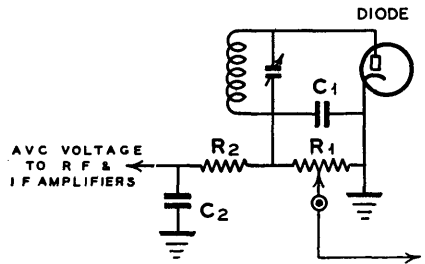

Figure 9. Typical a.v.c. circuit using diode.

A simple R-C (resistance-capacity) filter in the form of R_2 - C_2 may be connected to the diode circuit in order to utilize the d.c. voltage for automatic volume control purposes. This filter irons out the audio frequencies and also acts as a decoupling filter. The negative voltage developed across R_1 and C_2 has a value directly proportional to the incoming carrier signal. This voltage is used to bias the control grids of some of the r.f. and i.f. amplifier stages. An increased negative bias will reduce the amplification of the radio receiver so that a strong carrier, such as from a local broadcast station, furnishes approximately the same audio-frequency output signal as would be obtained from a distant broadcast station. Automatic

volume control has the further advantage of maintaining the audio signal at a fairly constant level, even though the signal from a distant station may be fading or varying in amplitude.

A great many different kinds of tubes are used for automatic volume control, but nearly all of these tubes operate on the principle of a diode rectifier.

Figure 10 shows a typical automatic volume control circuit which can be applied to almost any superheterodyne receiver.

Automatic Frequency Control

Many new receivers are equipped with automatic tuning dial mechanisms which require an addition to the electrical portion of the receiver in order to tune the circuits accurately to the carrier of the desired station. This is accomplished by *automatic frequency control*, which is an electrical device for varying the frequency of the oscillator from 5 to 15 kc. either side of the mechanically controlled circuit. Mechanically operated dials which tune to a fixed number of broadcast stations can be neither accurately set nor maintained in service on the exact frequency of each station. Automatic frequency control compensates for this defect, and, thus, there is no distortion due to mistuning.

The high-frequency r.f. and detector stages are not automatically compensated; therefore they must have a very broad tuning characteristic, preferably of the bandpass type. The automatic frequency control circuit consists of two parts, one of which discriminates between too high or too low a dial setting and, thereby, translates this effect into control voltages which are negative when

the dial is detuned in one direction, and positive when detuned in the opposite direction. The second portion of the circuit is to correct the high-frequency oscillator. This is accomplished by means of the 6J7 tube, as shown in figure 11.

A 6H6 can be used as an automatic volume control, detector and automatic frequency control tube, as indicated in figure 11. The principle of operation is based upon a phase difference when the applied frequency from the i.f. amplifier is too low or too high. Both capacitive and inductive coupling are used into the 6H6 tube; a phase difference results in the point in the cathode of the 6H6 tube having a positive or negative voltage which is impressed on the grid of the 6J7 corrector tube. Audio and a.v.c. voltages can be obtained from point Y, if desired.

The 6J7 tube acts as a variable impedance having the characteristics of an inductance or capacity, depending upon the bias on the grid of the tube. This tube is connected across the oscillator tuned circuit and, thereby, automatically tunes the oscillator circuit to a point which will heterodyne the incoming carrier signal into the exact frequency to which the i.f. amplifier is tuned. When this occurs, the phase relations in the 6H6 circuit are such that no further bias change is applied to the 6J7 tube.

Automatic frequency control has the disadvantage that the amount of correction varies with the wavelength of the incoming signal. This might result in an oscillator frequency change of as much as 100 kc. in the short-wave bands on an all-wave receiver incorporating a.f.c., so that a strong short-wave signal will detune the receiver from the desired station unless its own signal is very strong. For

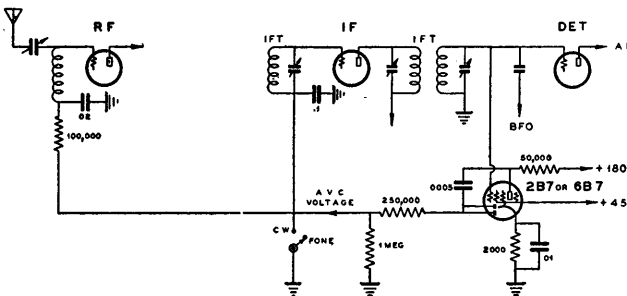

Figure 10. Automatic volume control is a distinct advantage when the receiver is used for phone reception. It automatically compensates for signal fading. Briefly, the carrier signal strength causes a control voltage to vary in proportion to the actual carrier intensity.

this reason, provision is made for switching out the a.f.c. circuit when tuning the short-wave bands.

Tuning Indicators

Visual means for determining whether or not the receiver is properly tuned, as well as an indication of the relative signal strength, are both provided by means of *tuning indicators* of the meter or vacuum tube types. Direct current milliammeters can be connected in the plate return circuit of an r.f. amplifier in such a manner that the change in plate current, due to the a.v.c. voltage which is supplied to that tube, will indicate proper tuning or *resonance*. Sometimes these d.c. meters are built in such a manner as to produce a shadow of varying width. Vacuum tube tuning indicators are designed so that an electron-ray eye changes its relative size when the input circuit of the tube is connected across part of the d.c. component of the automatic volume control circuit.

Beat-Frequency Oscillators

Beat-frequency oscillators, usually called the *b.f.o.* in superheterodyne re-

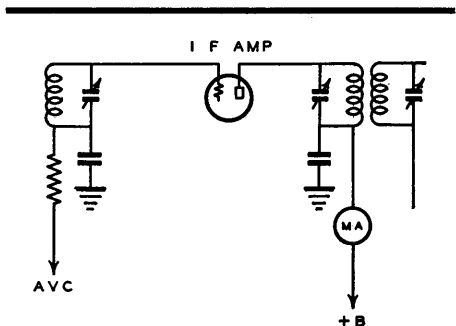
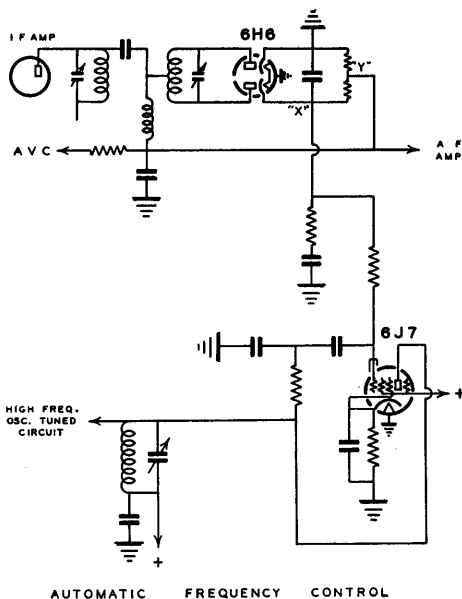

Figure 12. Circuit for using meter as tuning indicator.

ceivers, are a necessary adjunct for reception of c.w. telegraph signals on superheterodynes. The oscillator is coupled into the second detector circuit and supplies a weak signal of nearly the same frequency as that of the desired signal from the output of the i.f. amplifier. If the i.f. amplifier is tuned to 465 kc., for example, the b.f.o. is tuned to approximately 464 or 466 kc. in order to produce a 1,000-cycle beat note in the output of the second detector of the superheterodyne. The carrier signal would otherwise be inaudible. The b.f.o. is not used for voice reception, except as an aid in tuning a weak carrier to zero beat or in searching for weak stations.

The b.f.o. input to the second detector need only be sufficient to give a good beat note on an average signal. Too much coupling into the second detector will give an excessively high hiss level, masking weak signals by the high noise background.

This oscillator should be well shielded to prevent harmonics of the circuit from radiating into the front end of the radio receiver, thereby producing undesired whistles in various portions of the short-wave band. The b.f.o. circuit should have



AUTOMATIC FREQUENCY CONTROL
FIGURE 11.

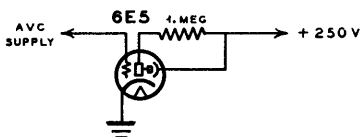

Figure 13. Electron-ray "tuning eye" indicator.

a high C-to-L ratio in order to obtain an output of good stability.

Crystal Filters

The selectivity of an intermediate-frequency amplifier can be greatly increased by means of a quartz crystal filter. This results in a better signal to noise ratio, and is a very satisfactory means for obtaining a high degree of selectivity in the i.f. amplifier. The

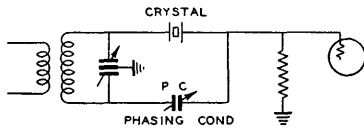

Figure 14. Simple crystal filter circuit.

quartz crystal is placed in the i.f. amplifier circuit in such a way that it acts as a very sharply resonant filter which will pass only an extremely narrow band of frequencies. A simple crystal filter circuit is shown in figure 14.

The crystal functions as a series-resonant circuit having a very high Q. The capacity across the crystal holder is neutralized by means of the phasing condenser and center-tapped tuning condenser or center-tapped input coil. The phasing condenser can also be made to change the selectivity characteristic of the filter circuit, and therefore this control always should be located on the front panel of the radio receiver.

The circuit in figure 15 will illustrate the principle of operation of a quartz crystal filter. The quartz crystal may be compared to the equivalent electrical circuit shown, where C_1 is the capacity across the quartz plate when not vibrating, R is the resistance equivalent to the frictional effects of the vibrating crystal, L the inductance corresponding to the inertia and C the capacity corresponding to the elasticity. On one side of resonance, the circuit has capacitive reactance, due to the elastic forces which control the crystal vibrations, while on the other side of resonance the reactance is inductive because of the effects of inertia. The crystal vibrates freely at resonance, its amplitude being limited by the frictional effects at resonance. L and

C are equal and opposite in reactance, the impedance is very low, and the resonant frequency is the same as the mechanical vibration mode.

A typical 451-kc. quartz crystal showed an equivalent inductance of 3.5 henrys and a series capacity of less than $0.1 \mu\text{fd}$. The effective Q may run as high as 10,000, which results in an extremely sharp resonant curve, not obtainable with ordinary condensers and coils. At frequencies slightly off-resonance, the series impedance is extremely high due to the minute series capacity C and enormous inductance L.

By placing the phasing condenser C, in the circuit so that the voltage across it is out of phase with that across the crystal, the parallel resonance can be shifted above or below the series crystal resonance. Thus, the phasing condenser can be adjusted so that the parallel resonance causes a sharp dip in the response curve at some desired point, such as 2 kc. from the desired signal peak. This effect can be utilized to eliminate completely the unwanted sideband 1 kc. away from zero beat for c.w. reception. The b.f.o. then provides a true single signal effect, that is, a single beat frequency note. This effectively increases the number of c.w. channels that can be used in any short-wave band. The series

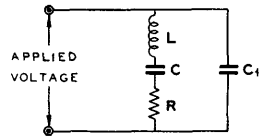

Figure 15. Equivalent circuit of a quartz crystal.

resonant effect of the crystal passes the desired signal through the i.f. amplifier for further amplification.

Other typical crystal filter circuits are shown in figures 16, 17 and 18.

The ideal response curve for an i.f. amplifier in either a phone or c.w. receiver would be *flat-topped* and *straight-sided*. The pass band would be somewhat wider for phone, however, than for c.w. An ideal c.w. curve would have a 300- or 400-cycle flat top, while for phone the flat top for good intelligibility and maximum freedom from QRM would be 3000 or 4000 cycles wide. The phone

fidelity would be impaired with this degree of selectivity because of the chopping off of the higher frequency sidebands, but the intelligibility would still be quite good in spite of the narrow pass band. The narrow pass band has the advantage of allowing one to discriminate between two stations quite close together in frequency without interference.

By *straight-sided* is meant that the response drops very rapidly to an extremely low value either side of the pass band. For freedom from interference from strong local stations, the response should drop at least 120 db; otherwise, the local may come through as bad interference even though not in the actual pass band. The high degree of attenuation is necessary because of the tremendous difference between the signal strength of a nearby station as compared to a distant one.

Series crystal circuits, as commonly used in single signal superheterodynes, give a very narrow response width at 465 kc. when the phasing condenser is set for maximum selectivity, and while the response is a little narrower than optimum for c.w., it can be broadened slightly by adjustment of the phasing condenser. However, a 465-kc. series crystal filter has a response too narrow for intelligible phone reception.

The main disadvantage of the series crystal filter is the presence of a wide skirt in the response curve; in other words, the response curve resembles a volcano. Thus it does not meet the straight-sided requirement of an ideal filter.

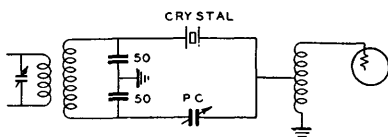

FIGURE 16.

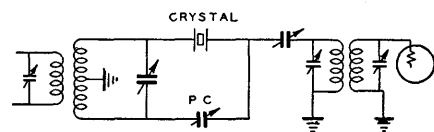

FIGURE 17.

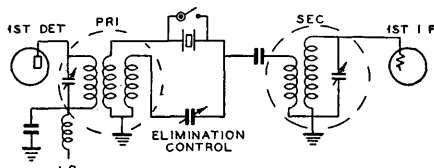

FIGURE 18.

Wide Band Crystal Filters

For radiophone reception, a higher frequency filter crystal and i.f. amplifier may be used to give a wider response curve. By using 1550 kc. instead of 465 kc., the filter will have a much wider pass band, wide enough to pass intelligible phone signals yet still sharp enough to be useful for c.w. reception.

The same effect is sometimes procured by using several quartz filter crystals in the 465-kc. vicinity in a suitable network. This gives a wider pass band the same as does a 1550-kc. crystal filter and at the same time has the additional advantage of steeper sides, or more rapid attenuation.

Another type of wide band filter is the *Transfilter*, an electromechanical device that is piezoelectric in action yet cannot be compared to a quartz crystal filter. Small, piezoelectric Rochelle salt crystal driver elements actuate a small, steel resonating rod. The device has higher mechanical damping than a quartz crystal resonator and, therefore, is not so sharp.

By the incorporation of impedance matching networks or tuned circuits in the filter circuit, it is possible to modify the shape of the response curve. This gives a control over the selectivity, and enables one to vary the band width from approximately 3 kc. up to 10 kc., making the device highly useful for amateur phone work.

Inasmuch as the Transfilter is commercially available as a complete resonator unit, detailed constructional data will not be given here. A word of warning is in order, however, to those designing receivers in which a Transfilter is to be used. The receiver should be so laid out mechanically and the filter unit placed so that it will not be heated by other components. Temperatures above 130 degrees F. will damage the small Rochelle salt crystal plates.

Noise Suppression

The problem of noise suppression confronts the listener who is located in such places where interference from power lines, electrical appliances and automobile ignition systems is troublesome. This noise is often of such intensity as to swamp out signals from desired stations.

There are three principal methods for reducing this noise:

- (1) A.c. line filters at the source of interference if the noise is created by an electrical appliance.
- (2) Noise-balancing circuits for the reduction of power-leak interference.
- (3) Noise-limiting circuits for the reduction of interference of the type caused by automobile ignition systems.

Line Filters

Household appliances, such as electric mixers, heating pads, vacuum sweepers, refrigerators, oil burners, sewing machines, doorbells, etc., create an interference of an intermittent nature. The insertion of a line filter near the source of interference often will effect a complete cure. Filters for small appliances can consist of a 0.1- μ fd. condenser connected across the 110-volt a.c. line. Two condensers in series across the line, with the midpoint connected to ground, can be used in conjunction with ultra-violet ray machines, refrigerators, oil burner furnaces and other more stubborn offenders. In severe cases of interference, additional filters in the form of heavy-duty r.f. choke coils must be connected in series with the 110-volt a.c. line on both sides of the line.

Noise-Balancing Systems

A very troublesome form of interference which has heretofore been incurable, except by elimination directly at the source, is that which is carried along the power lines. This form of interference is of such a continuous nature, or buzz, that none of the noise-limiting circuits has proved of value in reducing the noise. Noise limiters are effective only on popping types of noise, such as automobile ignition.

Power line noise interference can be

greatly reduced by the installation of a *noise-balancing* circuit ahead of the receiver, as shown in figure 19. The noise-balancing circuit adds the noise components from a separate noise antenna in such a manner that this noise antenna will buck the noise picked up by the regular receiving antenna. The noise antenna can consist of a connection to one side of the a.c. line, in some cases, while at other times an additional wire, 20 to 50 feet in length, can be run parallel to the a.c. house supply line. The noise antenna should pick up as much noise as possible in comparison with the amount of signal pickup. The regular receiving antenna should be a good-sized out-door antenna, so that the signal to noise ratio will be as high as possible. When the noise components are balanced out in the circuit ahead of the receiver, the signals will not be appreciably attenuated.

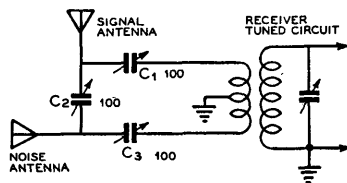

Figure 19. Jones noise-balancing circuit for reducing power leak and similar types of interference.

Noise-balancing is not a simple process; it requires a bit of experimentation in order to obtain good results. When proper adjustments have been made, it is possible to reduce the power leak noise from 3 to 5 R points without reducing the signal strength more than one R point, and in some cases there will be no reduction in signal strength whatsoever. This means that fairly weak signals can be received through terrific power leak interference. Hash type interference from electrical appliances can be reduced to a very low value by means of the same circuits.

The coil should be center-tapped and connected to the receiver ground connection in most cases. The pickup coil consists of four turns of hookup wire 2" in diameter which can be slipped over

the first r.f. tuned coil in most radio receivers. A two-turn coil is more appropriate for 10- and 20-meter operation, though the four-turn coil is suitable if care is taken in adjusting the condensers to avoid 10-meter resonance (unless very loose inductive coupling is used).

Adjustment of C_1 will generally allow a noise balance to be obtained when varying C_2 and C_3 in nearly any location. One antenna, then the other, can be removed to check for noise in the receiver. When properly balanced, the usual power line buzz can be balanced down nearly to zero without attenuating the desired signal more than 50%. This may result in the reception of an intelligible distant signal through extremely bad power line noise. Sometimes an incorrect adjustment will result in balancing out the signal as well as the noise. A good high antenna for signal reception will ordinarily overcome this effect.

Some readjustment is necessary from band to band in the short-wave spectrum; noise-balancing systems require a good deal of patience and experimenting at each particular receiving location.

Noise-Limiting Circuits

Numerous noise-limiting circuits have become popular. These circuits are beneficial in overcoming automobile ignition interference. They operate on the principle that each individual noise pulse is of very short duration, yet of extremely high amplitude. The popping or clicking type of noise from electrical ignition systems may produce a signal ten to twenty times as great as the incoming radio signal.

If the duration of the noise peak is sufficiently short, the receiver can be made inoperative during the noise peak without the human ear detecting the total loss of signal. Some noise limiters, or eliminators, actually *punch a hole* in the signal, while others merely *limit* the maximum peak signal which reaches the headphones or loudspeaker.

The noise peak is of such short duration that it would not be objectionable except for the fact that it produces an overloading effect on the receiver, which increases its time constant. A sharp voltage peak will give a kick to the diaphragm of the headphones or speaker, and the momentum or inertia keeps the

diaphragm in motion until the damping of the diaphragm stops it. This movement produces a popping sound which may completely obliterate the desired signal. If the noise peak can be limited to an amplitude equal to that of the desired signal, the resulting interference is practically negligible, except in extreme cases.

Noise Silencers for Connection Into I. F. Amplifier Circuits

Several noise-silencing or limiting circuits have been developed for connection into the i.f. or detector portions of a superheterodyne receiver. Tests conducted with a great many of these circuits have indicated that the one shown in figure 20 is among the most practical and desirable for use in amateur communications receivers. The noise-silencing action is entirely automatic and does not require readjustment for each incoming signal.

A double-diode, such as a 6H6, or two separate tubes are necessary for second detector and noise-suppression tubes. One diode acts as a second detector and a.v.c. tube, the other being connected across it as a noise-suppression tube. The principle of operation is as follows: The incoming carrier signal will build up a certain value of a.v.c. voltage across the 75,000- and 100,000-ohm resistors in the detector diode. The plate of the noise diode is connected across these two resistors, as well as the cathode of the noise diode, as shown in figure 23. The plate of the noise diode will re-

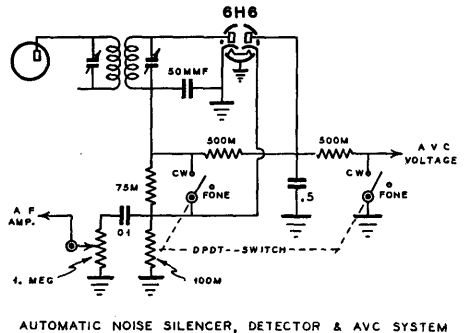

FIGURE 20.

main at the average potential developed by the a.v.c. voltage due to the carrier signal. The time constant of the $\frac{1}{2}$ -megohm resistor and $\frac{1}{2}$ - μ fd. condenser in the noise diode plate circuit will not follow the short pulse period of a noise signal. This noise pulse will act upon the cathode of the noise diode due to the very short time constant in that circuit. The noise peak causes the cathode to be more negative than the plate, so that the noise diode conducts current and drops to a very low impedance value. This effectively short-circuits the audio-frequency output for the duration of the noise pulse. Thus, it can be seen that this noise silencer will operate very effectively on noise pulses of short time duration, such as ignition noise, without destroying the intelligibility of the desired signal. However, in the case of a power leak which produces a more or less constant noise voltage, the signal would be blocked out for so great a time that it would be unintelligible.

The noise silencer shown in figure 20 can be used for either phone or c.w. reception, but is most effective for the latter. The noise diode for phone reception must be set so that it will not operate for noise pulses of an amplitude less than twice that of the incoming carrier signal; for c.w., the device can be made to operate for any noise pulse of greater intensity than the c.w. carrier. The changeover from phone to c.w. is accomplished by short-circuiting the 75,000-ohm resistor. This operation can be accomplished by means of a single-pole single-throw switch, or, if desired, by a double-pole single-throw switch, in which case the automatic volume control can simultaneously be cut off for c.w. reception.

A.F. Peak Limiters

Remarkably good noise suppression can be obtained in the audio amplifier of a radio receiver by using a delayed push-pull diode suppressor. Any twin diode tube can be used, though the type 84 high vacuum full-wave rectifier tube seems to be most effective.

The circuit in figure 21 can be used to describe the operation of this general type of noise suppressor or limiter. Each diode works on opposite noise voltages; that is, both sides of the noise voltage

(+ and - portions of the a.c. components) are applied to diodes which short-circuit the load whenever the applied voltage is greater than the delay voltage. The delay bias voltage prevents diode current from flowing for low-level audio voltages, and so the noise circuit has no effect on the desired signals except during the short interval of noise peaks. This interval is usually so short that the human ear will not notice a drop in signal during the small time that the load (headphones) is short-circuited by the diodes.

The delay bias voltage of $1\frac{1}{2}$ volts from a small flashlight cell will allow any signal voltage to operate the headphones which has a peak of less than about $1\frac{1}{2}$ volts. Noise peaks often have values of from 5 to 20 times as great as the desired signal; so these peaks operate the diodes, causing current to flow and a sudden drop in impedance across the headphones.

The diodes have nearly infinite impedance when no diode current is flowing; however, as soon as this starts, the impedance will drop to a very few hundred ohms, which tends to damp out or short circuit the audio output. The final result is that the noise level from automobile ignition is limited to values no greater than the desired signal. This is low enough to cause no trouble in understanding the voice or c.w. signals.

It is necessary to use a push-pull diode circuit because the noise peaks are of an a.c. nature and are not symmetrical with respect to the zero a.c. voltage reference level. The negative peaks may be greater than the positive peaks, depending on the bias and overload characteristics of the audio amplifier tube. If a single diode is used, only the positive (or negative) peaks could be suppressed. In figure 21 the two bias dry-cells are ar-

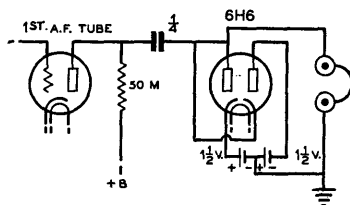

Figure 21. A.F. peak limiter for headphone operation.

ranged to place a negative bias on each diode plate of 1½ volts. A positive noise voltage peak at the plate of the audio amplifier tube will overcome this negative bias on the top diode plate and cause diode current to flow and lower the impedance. A negative noise voltage peak will overcome the positive bias on the other diode cathode and cause this diode to act as a noise suppressor. A positive bias on the cathode is the same as a negative bias on the diode plate. The 6H6 has two separate cathodes and plates, hence lends itself readily to the simple circuit illustrated in figure 21.

These circuits are very effective for noise elimination because they tend to punch a hole in the signal for the duration of a strong noise voltage peak. A peak that will cause a loudspeaker or headphones to rattle with a loud pop will be reduced to a faint pop by the noise-suppression system. The delay bias prevents any attenuation of the desired signal as long as the signal voltage is less than the bias.

It is possible to adjust the audio or sensitivity gain controls so that the auto

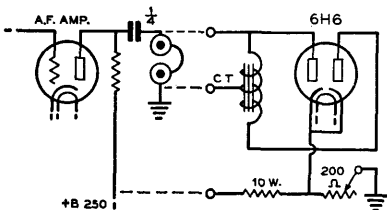

Figure 22. Noise limiter for connection to any receiver having isolated headphone output. The 10-watt series dropping resistor should be between 15,000 and 20,000 ohms.

a weak rattle or series of pops in the headphones.

The two noise-limiter circuits shown in figures 22 and 23 can be used as separate units for connection to any receiver. The unit shown in figure 22 can be connected across any headphone output as long as there is no d.c. current flowing through the latter. A blocking

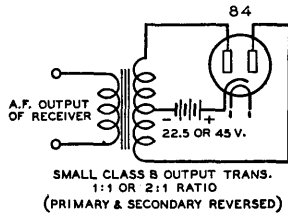

Figure 23. This noise limiter may be connected to any receiver having loudspeaker output. For headphone operation, much less delay bias should be used.

condenser can be connected in series with it if necessary, though better noise suppression results when the blocking condenser is in series with the plate lead to the headphones. Delay bias is obtained from the plus B supply through a 15,000-ohm 10-watt resistor and a 200-ohm wire-wound variable resistor. The cathode or cathodes are made a volt or so positive with respect to ground and minus B connection.

The diode plates are connected through a center-tapped low resistance choke to ground as far as bias voltage is concerned. Any push-pull to voice coil output transformer can be used for the center-tapped choke in figure 22. The secondary can be left open. The delay bias is adjustable from 0 up to about 3 volts and once set for some noise level, can be left in that position.

The unit illustrated in figure 23 can be connected across any audio amplifier stage, even the output stage which drives a loudspeaker. Any bias from 1½ to 90 volts or more can be connected in series with the center tap and 84 tube cathode. The higher values of delay bias would be needed for high output levels from the loudspeaker. Generally, 22½- to 45-volts bias will allow enough delay to allow moderate room volume

ignition QRM seems to drop out, leaving only the desired signal with a small amount of distortion. Lower gain settings will allow some noise to get through but will eliminate audio distortion on voice or music reception. At high levels the speech or music peaks will be attenuated whenever they exceed the d.c. delay bias voltage. Faint ignition rattle will always be audible in the background with any noise-suppressor circuit since some noise peaks are too small to operate the systems, yet are still audible as

reception of the desired voice signals without leveling off and distortion. As low a delay bias should be used as possible without distortion in order to obtain effective noise suppression.

Practical applications of various modifications of the noise limiters described

in this chapter will be found in the following chapter on receiver construction.

A more detailed and comprehensive discussion of noise balancing and noise limiting systems will be found in the *RADIO Noise Reduction Handbook*.

RECEIVER ADJUSTMENT

Good results can only be obtained from a radio receiver when it is properly aligned and adjusted. The most practical technique for making these adjustments is given in the following discussion.

The simplest type of regenerative receiver requires little adjustment other than those necessary to insure correct tuning and smooth regeneration over some desired range. Receivers of the tuned radio-frequency type and superheterodynes require precise alignment to obtain the highest possible degree of selectivity and sensitivity.

Test Instruments

A very small number of instruments will suffice to check and align any multi-tube receiver, the most important of these testing units being a modulated oscillator and a d.c. and a.c. voltmeter. The meters are essential in checking the voltage applied at *each* circuit point from the power supply. *NOTE:* If the a.c. voltmeter is of the oxide-rectifier type, it can be used, in addition, as an output meter when connected across the receiver output when tuning to a modulated signal. If the signal is a steady tone, such as from a test oscillator, the output meter will indicate the value of the detected signal. In this manner, line-up adjustments may be visually noted on the meter rather than by increases or decreases of sound intensity as detected by ear.

Tuned R. F. Receiver Alignment

The alignment procedure in a multi-stage r.f. receiver is exactly the same as aligning a single stage. If the detector is regenerative, each preceding stage is successively aligned while keeping the detector circuit tuned to the test signal, the latter being a station

signal or one locally generated by a test oscillator loosely coupled to the antenna lead. During these adjustments, the r.f. amplifier gain control is adjusted for maximum sensitivity, assuming that the r.f. amplifier is stable and does not oscillate. Oscillation is indicative of improper by-passing or shielding. Often a sensitive receiver can be roughly aligned by tuning for maximum noise pickup, such as parasitic oscillations originating from static or electrical machinery.

Superheterodyne Alignment

The alignment of a superhet is a detailed task requiring a great amount of care and patience. It should never be undertaken without a thorough understanding of the involved job to be done and then only when there is abundant time to devote to the operation. There are no short cuts; every circuit must be adjusted individually and accurately if the receiver is to give peak performance. The precision of each adjustment is dependent upon the accuracy with which the preceding one was made.

Superhet alignment requires (1) a good signal generator (modulated oscillator) covering the radio and intermediate frequencies and equipped with an attenuator and B-plus switch; (2) the necessary socket wrenches, screwdrivers, or "neutralizing tools" to adjust the various i.f. and r.f. trimmer condensers, and (3) some convenient type of tuning indicator, such as a copper-oxide or electronic voltmeter. The last item is optional since most of the adjustments will be made by ear and the meter will serve only as a visual check. It is dispensed with entirely by some manufacturers of good communications receivers.

Throughout the alignment process, unless specifically stated otherwise, the a.f.

and r.f. gain controls must be set for maximum output, the beat oscillator switched off, the R-meter cut out, the crystal filter set for minimum selectivity and the a.v.c. turned off. If no provision is made for a.v.c. switching, the signal generator output must be reduced to the proper level by means of the attenuator. When the signal output of the receiver is excessive, either the attenuator or the a.f. gain control may be turned down, but never the r.f. gain control.

I. F. Alignment

Assuming that the receiver has been given a rigid electrical and mechanical inspection and that no faults have been found in wiring or the selection and assembly of parts, the i.f. amplifier may be aligned as the first step in the checking operations.

The coils for the r.f. (if any), first detector and high-frequency oscillator stages must be in place. It is immaterial which coils are inserted, since they will serve during the i.f. alignment only to prevent open-grid oscillation. However, in order to save a changeover operation, it is suggested that those covering the lowest-frequency band be used, since they will be the first ones tackled in the front-end alignment.

Set the signal generator for a modulated signal on the frequency at which the i.f. amplifier is to operate and clip the output leads from the generator to the last i.f. stage; "hot" end to the control grid, "cold" end to the receiver ground. Adjust both trimmer condensers in the last i.f. transformer (C_3 and C_4 in figure 24) to resonance as indicated by signal peak in the headphones or speaker and maximum deflection of the tuning meter.

Adjust each i.f. stage in the same manner, moving the hot lead, stage by stage, back toward the front end of the receiver and backing off the attenuator

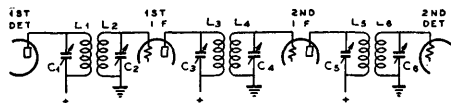

Figure 24. I. F. amplifier.

as the signal strength increases in each new position. The last adjustment will be made to the first i.f. transformer with the hot lead connected to the control grid of the first detector. Occasionally, it is necessary to disconnect the 1st detector grid lead from the coil, grounding it through a 1,000- or 5,000-ohm grid leak and coupling the signal generator through a small capacitance to the grid.

After the last i.f. adjustment, it is good practice to go back through the i.f. channel, re-peaking all of the transformers. It is imperative that this recheck be made in sets which do not include a crystal filter and where necessarily the simple alignment of the i.f. amplifier to the generator is final.

B. F. Oscillator Adjustment

An unmodulated signal provided by the generator is tuned in through the front

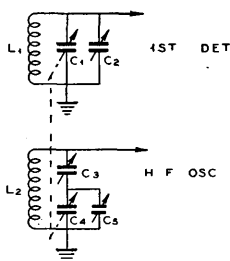

Figure 25. Front end of superheterodyne.

end of the receiver. The frequency of this signal is unimportant. Though no beat note is present, the carrier which is received as a hiss or rushing sound can be set to zero beat by tuning the receiver to the point of exact null. There is absolute silence ("hole-in-the-back-ground noise") at exact resonance with an unmodulated signal.

With the set tuned to resonance with the signal, switch on the beat oscillator and set its pitch-control dial to the point where it is desired to have zero beat fall. Then set the beat oscillator to zero beat with the incoming signal by adjusting the trimmer(s) on the b.f.o. "transformer." The latter is usually so far out of adjustment in the beginning that no heterodyne note will be heard until some adjustment is made to the trimmers.

It is suggested that the point of zero beat be located one or two dial divisions from one end of the pitch-control dial in order that the pitch may have the widest

possible controllable range. The range is tested by turning the pitch-control dial through its entire scale and should extend from zero beat to the limit of audibility.

Adjusting the Crystal Filter

Since the quartz plates used in crystal filters oscillate and resonate at different frequencies, it is recommended that the filter be aligned with the crystal in the filter rather than in an external oscillator.

The beat oscillator is switched on and the selectivity and phasing controls of the filter set for *maximum* selectivity. Pick up any convenient unmodulated signal from the generator through the front end of the set, noting that there is a pronounced peak on tuning slowly through the signal. At this peak the signal has a clear bell-like intensification. It is a very sharp point, easily passed over, which must be approached cautiously and it may be necessary to back up the attenuator considerably to prevent motorboating. The beat oscillator may be adjusted to any pleasing pitch. The entire i.f. channel is aligned to the crystal frequency by peaking each of the i.f. trimmers to this sharp signal.

When the peaking is completed, the phasing condenser and input tuning condenser should be adjusted simultaneously for maximum signal response, then a slight readjustment of the phasing condenser will eliminate the other sideband. After the alignment of the i.f. channel to the crystal is completed, the beat oscillator must be switched off and the crystal filter reset to the position of *minimum* selectivity for the front-end operations.

Detector-Oscillator Procedure

Before the front-end alignment is begun, inspect the tuning condenser sections for good "fitting." All the plates must be made perfectly parallel throughout the tuning range if the set is to possess uniform sensitivity throughout the tuning ranges and if ganging operations are to be facilitated.

The front-end work begins with the high-frequency oscillator. Insert the lowest frequency coils (160- or 80-meter range in ham receivers) and set the main tuning dial to the point where it is desired to have the highest frequency in the band fall. Couple the signal generator to the antenna input and provide

an unmodulated signal on the high-frequency band limit of the low-frequency band. (2,000 or 4,000 kc. as the case may be.)

Adjust the parallel trimmer of the h.f. oscillator coil (C_2 , figure 25) slowly from maximum capacity until the generator signal is picked up. Two separate signals will be encountered; one at the high-capacity (low-frequency) setting of the trimmer, the other near the low-capacity (high-frequency) setting. The desired signal is the highest frequency one, since the h.f. oscillator is to be operated at a higher frequency than the incoming signal. The lower frequency signal represents the image setting. This is occasioned by the fact that two settings of the h.f. oscillator will provide signals which will beat with the incoming signal to produce a third signal on the intermediate frequency. The frequency of the first setting is numerically equal to the intermediate frequency plus the frequency of the incoming signal; the other to the intermediate frequency minus the signal frequency. When one or more efficient r.f. stages are employed ahead of the first detector, the image will usually be attenuated sufficiently to make it readily distinguishable from the real signal.

After the h.f. oscillator has been set to the high-frequency signal, the generator is switched off by opening its B-plus switch and the other stages, starting with the 1st detector, are peaked at the same setting of the tuning dial by adjusting the parallel trimmers (as C_2 , figure 25) for peak in the background noise. If the receiver has no r.f. stages, the background noise due to thermal agitation in the front-end tubes may not be loud enough for the purpose, and a modulated signal will be necessary for detector trimmer adjustments. The trimmer is then set for signal peak.

In setting the detector and r.f. trimmers it is possible, as in the case of the h.f. oscillator, to select the image setting. The real signal is the low-frequency (high-capacity) one in this case, since the detector and r.f. stages are to operate at a lower frequency than the h.f. oscillator.

If the adjustments have been made by means of set noise, the unmodulated signal is again supplied and the h.f. oscillator setting rechecked. There should not be enough interaction between the h.f. os-

illator and other front-end stages on 160, 80 and 40 meters to shift the oscillator setting when making detector or r.f. adjustments. Interlocking is violent, however, on 10 and 20 meters and the recheck is apt to show that the signal has been displaced several dial divisions during the detector-r.f. adjustments. If the signal is found to be displaced, it is necessary to reset the h.f. oscillator and detector-r.f. circuits and in turn to recheck the oscillator, repeating the process until the outfit settles down.

After the front-end circuits have been set at the high-frequency end of the band, the generator is adjusted for an unmodulated signal on the lowest frequency in the band and the receiver is tuned to locate this signal. It is a matter of good fortune when this signal is tuned in at the desired point on the dial. Almost invariably it will be located many dial divisions above or below the proper reading, sometimes off the low end of the dial entirely.

If the signal is below the desired point, the capacitance of the series padder (C_s , figure 25) must be increased. Conversely, if it is above the desired point, the capacitance must be decreased. Whichever the case, the signal must be carried to the other side of the desired point (by cut-and-try adjustment of C_s), a distance equal to the same number of dial divisions by which it is already displaced and then retuned at the proper dial setting by adjusting C_s .

As an example, suppose the 4,000-kc. end of the 80-meter band has been set and 3,500, which should fall on 10 on the dial, is found at 15. The signal is five divisions higher than desired, so the capacitance of C_s is decreased progressively until 3,500 is tuned in at 5, or five divisions on the opposite side of the desired dial reading. Then with the dial set at 10, 3,500 is retuned by adjusting C_s .

Whenever any adjustment is made to any circuit at the low-frequency end of the band, it is necessary to readjust the circuit at the high-frequency end. So, after making the low-frequency band-setting adjustment explained in the foregoing, it is necessary to reset C_s to the high-frequency signal with the set tuned to the high-frequency band limit. It will then be necessary to return to the low-frequency end, repeating the adjustments to series and parallel padder condensers

there, repeating the process until the high- and low-frequency band limits coincide with the desired points on the dial.

After the h.f. oscillator has been set according to the foregoing directions, the generator is switched off and the detector-r.f. sections checked for tracking as follows. If the circuits contain only parallel trimmers (as C_2 , figure 25) and these have, of course, already been set at the high-frequency end of the band, the set is tuned to the low-frequency end of the band and each circuit checked by pulling out and pressing in the outside plates of the individual tuning condenser sections, noting in which direction the plates must be moved in order to bring up the background noise or modulated signal to a sharply defined peak. If the plates must be moved only slightly, they are bent permanently to give the required separation. Drastic bending is to be avoided, however. If more than one eighth of an inch bend is required in any section, the corresponding coil should be pruned as indicated rather than produce an unsightly bend in the condenser plate. If increasing the capacitance of the condenser (pushing the plates together) brings up the peak, the inductance of the coil must be increased. Decreasing the capacitance (pulling plates apart) indicates that the inductance of the coil must be decreased. These operations are purely cut and try and require a great deal of patience.

When the only low-frequency adjustment has been gentle plate-bending, readjustment at the high-frequency end is not necessary. But if the coil inductance has been altered, the corresponding parallel trimmer must be readjusted at the high-frequency end of the band.

Although the high-frequency oscillator and the detector and r.f. stages have been set at both ends, intermediate points throughout the tuning range may be considerably out of gang. Both oscillator and detector-r.f. sections must be checked at points at the most a quarter-inch apart throughout the tuning range of the condenser, bending the plates as the test indicates. When bending the outside plates in the vicinity of the band limits, care must be exercised to prevent shifting the high- and low-frequency settings made previously. If the band-limit signal positions are inadvertently shifted, bending the condenser plates outward will recover a signal that has wandered up the

dial; bending the plates inward will recover one that has gone down the dial. This bending must be done at dial settings for the band limits.

If the detector and r.f. stages contain series padders, arranged as in the oscillator section in figure 25, they are adjusted with the parallel padders as explained in the section on h.f. oscillator adjustments. It must be borne in mind, however, that the series padder adjustments merely set the bandwidth and plates must still be bent to insure tracking at the intermediate points throughout the range.

Perfect Tracking

Perfect tracking is evidenced by a uniform level in the background noise as the set is tuned through any waveband. If the end plates of any condenser section are bent gently in either direction in a well-tracked front end, the background noise level should decrease.

Condenser plates are bent only on the lowest frequency coil range. With the other coils, band limits are set in the same manner and tracking tests made by gently testing with the condenser end plates, but the indicated adjustments are made to corresponding coils rather than to condensers. How well the higher frequency coils can be made to fall in line by careful pruning of their inductance values depends upon the efficacy of the ganging job on the lowest frequency range.

A. V. C. Checking

The automatic volume control system is checked by picking up a modulated signal with a.v.c. switched off and running the r.f. gain control to a point where the receiver blocks. Switching on the a.v.c. should relieve this blocking.

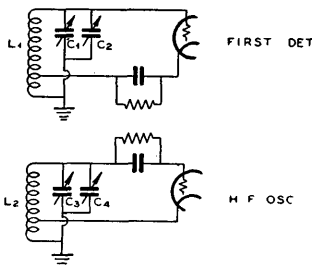

Figure 26. Another type of front end.

Multiband Receivers

Individual coils in multiband receivers with coil switching arrangements or

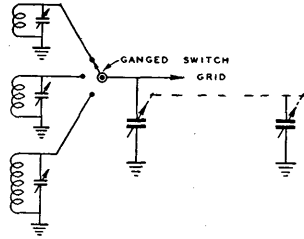

Figure 27. Tuned circuits for coil switching.

plug-in coils must have small trimmer condensers shunted across the inductive circuits, as shown in figure 27. This allows fairly accurate alignment in each band by following the procedure previously outlined. In assembling a superheterodyne, the labor of checking is rather long and tedious since each coil must have *exactly* the correct inductance because bending the main tuning condenser plates would unbalance or misalign all other coils.

Unfortunately, in receivers incorporating coil switching arrangements, it is impossible to obtain *accurate* circuit alignment on *all* coils. Many commercially built receivers use two stages of r.f. ahead of the first detector, tuned rather broadly in order to overcome this defect and obtain better signal to noise and image ratios.

The foregoing applies to the *all-wave* communications receivers and not to bandswitching or plug-in coil receivers designed to cover only the relatively narrow amateur bands; tracking is not such a problem in the latter type receivers.

If either the r.f. stage or first detector is regenerative, it must track closely with the h.f. oscillator. This type of circuit is shown in figure 26 where C_1 and C_3 are approximately $25\text{-}\mu\text{fd.}$ ganged tuning condensers on the main tuning dial, and C_2 and C_4 are bandsetting condensers of 100 to $140\ \mu\text{fd.}$ In this instance, C_2 can be used as a panel-operated trimmer condenser to hold the circuits exactly in line at high degrees of regeneration. The series padding condenser C_3 of figure 25 is not required in this class of receiver due to the very

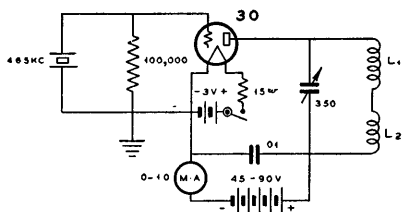

TEST OSCILLATOR CIRCUIT

Figure 28. Rough alignment of crystal filter.

narrow band tuning range of C_1 and C_3 . The coil turns on L_1 and L_2 can be adjusted so that at random settings of C_2 and C_4 they will give practically perfect alignment. Varying the coil turns and spacing between turns will insure good tracking throughout all the amateur bands with the possible exception of the 160-meter band. This form of receiver invariably uses plug-in coils which first must be adjusted properly, the turns then being cemented in place.

Alternative Crystal Filter Alignment

In lining up a new i.f. amplifier for use with a crystal filter, it is customary to employ the crystal itself as an oscillator. The circuit shown in figure 28 can be used. A winding from an i.f. transformer can be used for the plate inductance. If none is handy, a b.f.o. coil can be used as shown in the diagram. In either case, it is necessary to disconnect the trimmer across the winding unless it has sufficient maximum capacity to be used in place of the 350- μ fd. tuning condenser indicated in the diagram.

A milliammeter inserted in the plate circuit will indicate oscillation, the plate current dipping as the condenser tunes the inductance to the resonant frequency of the crystal. Some crystals will require additional grid-plate capacity for oscillation; if so, a 30- μ fd. mica trimmer may be connected from plate to grid of the oscillator tube. The oscillator is then used as a line-up oscillator as described earlier in this chapter by using a.c. for plate supply instead of batteries.

Exact i.f. alignment should be made with the crystal *in the circuit*, after the

preliminary adjustment is made, because the crystal frequency is not *exactly* the same in a resonator as in an oscillator.

In adjusting the crystal filter, the phasing condenser and input tuning condenser should be adjusted simultaneously for maximum signal response, then a slight readjustment of the phasing condenser will allow elimination of the other sideband.

Notes

In lining up a receiver which has automatic volume control (a.v.c.), it is considered good practice to keep the test oscillator signal near the threshold sensitivity at all times to give the effect of a very weak signal relative to the audio amplifier output with the audio gain control on maximum setting.

In checking over a receiver, certain troubles are often difficult to locate. By making voltage or continuity tests, blown-out condensers, or burned-out resistors, coils or transformers may usually be located. Oscillators are usually checked by means of a d.c. voltmeter connected from ground to screen or plate-return circuits. Short-circuiting the tuning condenser plates usually produce a change in voltmeter reading. A vacuum-tube-type voltmeter is very handy for the purpose of measuring the correct amount of oscillator r.f. voltage supplied to the first detector circuit. The proper value of the r.f. voltage is approximately one volt less than the fixed grid bias on the first detector when the voltage is introduced into either the grid or the cathode circuit.

Incorrect voltages, poor resistors or leaky by-pass or blocking condensers will ruin the audio tone of the receiver. Defective tubes can be checked in a tube tester. Loud-speaker rattle is not always a defect in the voice coil or spider support, or metallic filings in its air gap; more often the distortion is caused by overloading the audio amplifier. An i.f. amplifier can also impair splendid tone due to a defective tube or overloading of the final i.f. tube. In some circuits, the last i.f. tube will overload on strong carrier signals. Diode detectors provide best fidelity when operated at fairly high input levels, which means that there must be ample voltage swing delivered by the last i.f. tube.

CHAPTER 8

Radio Receiver Construction

Regenerative, Tuned R.F. and Superheterodyne Sets— Specifications and Building Instruction—Coil Winding Tables—U.H.F. Construction

A RECEIVER of modest cost, incorporating a dual-triode tube which serves the combined purpose of a detector and audio amplifier, is shown in figure 1. This receiver operates from a single dry cell for the filament supply, and a 45-volt B battery for plate supply. The type RK43 dual-triode tube enables this receiver to give performance comparable with that of any other dry cell operated receiver in which two separate tubes are used for detection and audio amplification.

The receiver is of the regenerative type, regeneration being controlled by means of a midget variable condenser of 100 μfd . capacity. Bandsread tuning is accomplished by means of a 15- μfd . midget variable condenser in shunt with the main tank condenser of 100 μfd .

The 1½-volt filament of the type RK43 makes possible the use of the tube without a filament rheostat; the filament is supplied directly from a standard 1½-volt dry cell. As the filament draws only 0.12 amp., many hours of operation are possible from a single 1½-volt cell. Besides eliminating the extra dry cell and rheostat required for a type 19 tube, the RK43 is slightly less microphonic. These advantages justify the slight additional cost of the type RK43 over a type 19 dual triode.

The total plate current drain is only about 2 ma. This means that the least expensive size 45-volt B battery may be utilized with good economy. Because the current drain is so low, there will be little increase in battery life if a heavy-duty B battery is used.

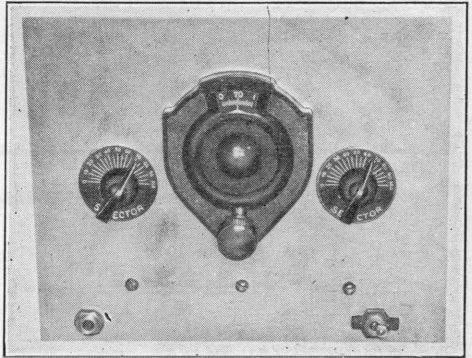

Figure 1. A simple one-tube receiver that not only gives excellent performance but is easy and inexpensive to construct. It uses a dual triode having a 1½-volt filament.

For portable work, a midget 45-volt battery may be used for plate supply; these batteries have shorter life and cost slightly more than the standard light-duty type, but possess the advantage of being small enough that they may be placed inside the receiver cabinet. Figure 5 illustrates a portable version of the receiver, in which a large size flashlight cell is used for filament supply and a midget 45-volt battery is used for plate supply. The batteries are self-contained.

The receiver illustrated in figures 1, 2 and 4 is constructed on a chassis measuring 6"x8"x2". The panel, of 12-gauge aluminum, is 8½" wide and 7" high. The slow motion dial is a distinct aid in tuning.

The receiver is capable of covering all of the amateur and intermediate short-wave bands from 20 to 160 meters by winding a set of four separate coils on

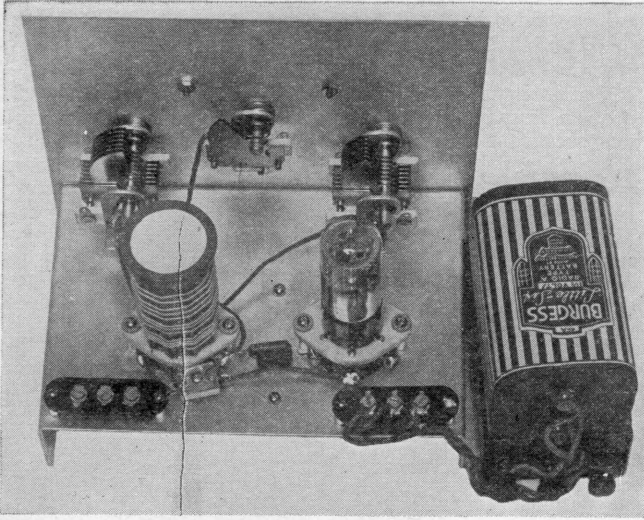
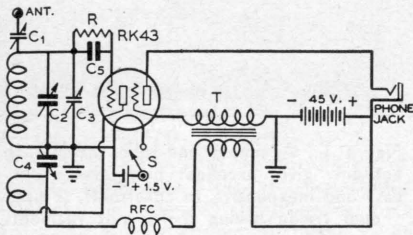

Figure 2. Showing layout of parts for the RK43 dual-triode receiver. Careful adherence to the physical arrangement shown will minimize the chances for trouble.

FIGURE 3. SCHEMATIC DIAGRAM OF THE DUAL-TRIODE RECEIVER.



- C₁—3-30- μ fd. mica trimmer, antenna coupling
- C₂—15- μ fd. midget variable, band-spread
- C₃—100- μ fd. midget variable, band-set
- C₄—100- μ fd. midget variable, re-generation control
- C₅—.0001- μ fd. midget mica
- R—3 megohms, $\frac{1}{2}$ watt
- T—3:1 audio transformer
- S—Filament on-off switch
- RFC—2 $\frac{1}{2}$ -mh., 125-ma. midget r.f. choke
- Coils—See data elsewhere

Figure 4. Under chassis view of the receiver, showing placement of r.f. choke and audio transformer. Note hole cut out for tube socket.

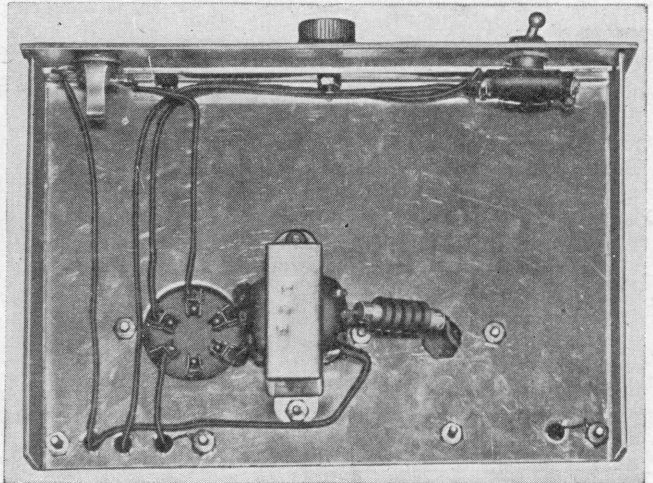

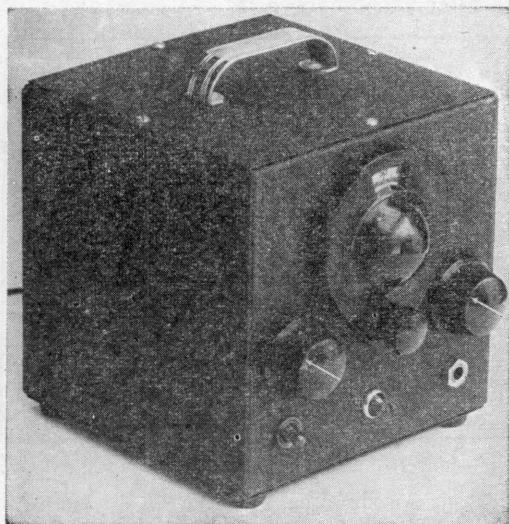

Figure 5. For portable work, the RK43 receiver and batteries may be enclosed in a cabinet similar to the one here.

standard 1½-in. diameter 4-prong plug-in coil forms. Complete coil data and specifications are given in the coil table.

The only major precaution in building this receiver is to guard against incorrect wiring of the 6-prong socket which holds the type RK43 tube. By referring to the socket connection data given by the manufacturer and taking care to "pair off" the sections properly, no trouble

should be experienced. Correct polarity of the tickler leads is imperative, but figure 6 should enable one to get the coil connections correct with little difficulty. Careful adherence to the parts layout shown in the illustrations is strongly advised for the constructor attempting his first receiver.

The small mica trimmer condenser used for antenna coupling should be

The upper coil is the grid (secondary) coil. Start the winding at point 1; make the connection to prong 1. The bottom of the grid coil (2) connects to prong 2. The top of the tickler coil (3) connects to prong 3; the bottom of the tickler (4) connects to prong 4. Mark the coil prongs and the coil socket contacts to correspond with these numbers. See the pictorial layout to show how the connections are made to the coil socket. Make certain that connection no. 1 goes to the stators of both tuning condensers, and also to one side of the .0001- μ fd. grid condenser. Likewise, take care to see that connection no. 4 goes to the plate of the detector portion (P2) of the tube. If these connections are not properly made, the receiver will not function.

Terminal no. 1 connects to one side of the .0001- μ fd. mica fixed condenser and to the stator of the 100- μ fd. condenser, as well as to the stator of the 3-plate midget variable tuning condenser.

Terminal no. 2 connects to the rotors of all three variable condensers, and at the point where the three are connected together another lead is run to the "ground" terminal of the receiver.

FIGURE 6. COIL DATA

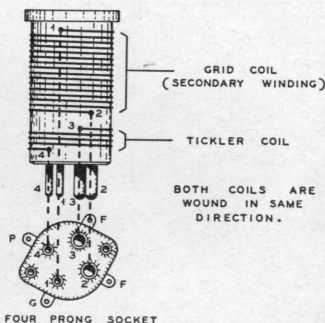

Terminal no. 3 connects to the stator of the variable condenser which is used for regeneration, and the same terminal also connects to one end of the 2.5-mh. r.f. choke.

Terminal no. 4 connects to the P2 terminal on the type RK43 tube.

COIL TABLE FOR THE DUAL-TRIODE RECEIVER.

The secondary coil and the tickler coil are both wound in the same direction.

20-Meter Coil: Secondary winding—7 turns of no. 22 d.s.c., space wound to cover a winding of 1".

Tickler winding—5 turns of no. 22 d.s.c., closewound and spaced about $\frac{1}{8}$ " from the secondary winding.

40-Meter Coil: Secondary winding—14 turns of no. 22 d.s.c., space wound to cover a winding space of 1".

Tickler winding—11 turns of no. 22 d.s.c., closewound and spaced $\frac{1}{8}$ " from secondary winding.

80-Meter Coil: Secondary winding—27 turns of no. 22 d.s.c., closewound.

Tickler winding—11 turns of no. 22 d.s.c., closewound, and spaced $\frac{1}{8}$ " from secondary winding.

160-Meter Coil: Secondary winding—60 turns of no. 22 d.s.c., closewound.

Tickler winding—17 turns of no. 32 enameled, closewound, and spaced $\frac{1}{8}$ " from secondary winding.

backed off until it is possible to make the receiver oscillate over the whole amateur band. It will sometimes require readjustment when changing coils.

An antenna of from 75 to 100 feet (overall), as much in the clear as possible, will provide good reception on all the amateur bands.

STANDARD REGENERATIVE "GAINER" RECEIVER

An a.c. operated receiver which also can be used with dry cells and which gives greater sensitivity and more volume than the single-tube receiver previously described, is the two-tube standard regenerative "Gainer".

The circuit consists of a regenerative

detector having excellent sensitivity and an impedance-coupled audio amplifier stage which gives sufficient volume for headphone reception. Loud-speaker operation of the receiver would require an additional audio amplifier stage.

The main tuning control drives a small bandspread tuning condenser. A band-setting variable condenser is controlled from the front panel by means of a knob and pointer and small dial. The third front-panel control is for adjustment of regeneration, which is accomplished by varying the screen-grid voltage of the detector tube. The band-setting condenser is adjusted to the desired band, and the actual tuning is done with the bandspread condenser which is connected to the vernier tuning dial.

Regeneration is obtained by means of a cathode tap in the tuned grid circuit. Standard plug-in coils are used to cover the various amateur bands, as shown in the coil-winding table.

Grid leak detection gives maximum sensitivity and smooth control of regeneration, which is adjusted by varying the screen-grid voltage applied to the 6C6 tube. The screen-grid lead has an

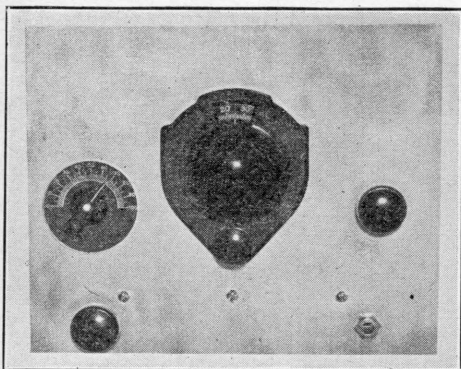

Figure 7. Front panel view of the standard regenerative "Gainer" receiver. The pointer knob controls the bandset condenser, the main vernier dial the bandspread condenser and the knob to the right the audio gain control. The lower left-hand knob is the regeneration control.

additional resistance filter in the circuit to prevent noise from being introduced into the detector circuit when varying the screen-grid potentiometer. Impedance coupling allows full plate voltage to be applied to the plate of the screen-grid tube and results in louder signals than would be secured with ordinary resistance coupling. The type 6L5-G audio amplifier is conventional, with a resistor and condenser in the plate circuit to remove the d.c. plate potential from the headphones.

The high impedance choke in the detector plate circuit should be one designed to carry approximately 5 milliamperes of plate current, with an inductance of between 300 and 500 henrys. A 250,000-ohm resistor connected across this choke will prevent "fringe-howl" when the detector tube is used near the edge of oscillation.

The detector grid leak and grid condenser should be mounted as close as possible to the grid cap of the 6S7-G detector tube to prevent hum pickup. The 0.1- μ fd. condenser which is connected across the positive and negative terminals of the B supply in the receiver prevents what is known as "tunable hum" in some of the short-wave bands when the receiver is operated from an a.c. source of supply.

Construction

The receiver is constructed on a metal chassis 6"x8"x1 $\frac{1}{2}$ " and has a front

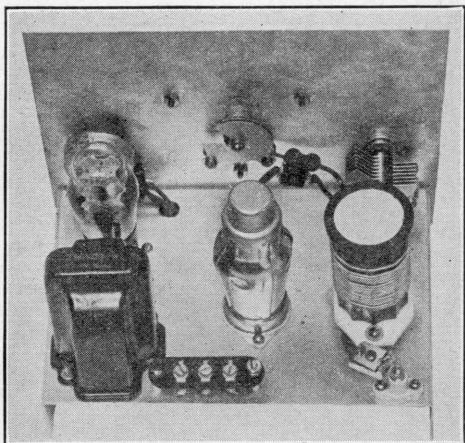
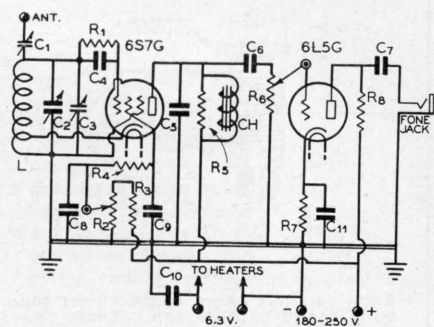

Figure 8. Showing arrangement of components in the standard "Gainer." The tube shield and short detector grid lead are necessary to avoid "grid hum."

panel of 12-gauge aluminum measuring 8 $\frac{1}{2}$ "x7" high. The use of a metal chassis and front panel minimizes body capacity effects and simplifies wiring, as ground leads—except those that must be kept as short as possible—may be soldered directly to the metal chassis. The correct position of the various components can be assured by following the three illustrations of the receiver.

All coils are wound on standard four-prong coil forms. The coil table gives the correct number of turns of wire for each of the required coils.

FIGURE 9. SCHEMATIC WIRING DIAGRAM OF THE STANDARD "GAINER" TWO-TUBE REGENERATIVE RECEIVER.



- C₁—3-30- μ fd. mica trimmer
- C₂—0.001- μ fd. mid-get mica
- C₃—0.001- μ fd. mid-get mica
- C₄—0.001- μ fd. mid-get mica
- C₅—0.005- μ fd. 400-volt tubular
- C₆—0.1- μ fd. 400-volt tubular
- C₇—0.1- μ fd. 400-volt tubular
- C₈—0.1- μ fd. 400-volt tubular
- C₉—0.5- μ fd. 400-volt tubular
- C₁₀—0.1- μ fd. 400-volt tubular
- C₁₁—0.5- μ fd. 400-volt tubular
- R₁—5 megohms, $\frac{1}{2}$ watt
- R₂—50,000-ohm potentiometer
- R₃—20,000 ohms, 1 watt
- R₄—50,000 ohms, $\frac{1}{2}$ watt
- R₅—250,000 ohms, $\frac{1}{2}$ watt
- R₆—1- megohm potentiometer
- R₇—2000 ohms, $\frac{1}{2}$ watt
- R₈—50,000 ohms, 1 watt
- CH—500-hy. plate choke

- C₃—100- μ fd. mid-get variable
- C₄—0.001- μ fd. mid-get mica
- C₅—0.001- μ fd. mid-get mica
- C₆—0.005- μ fd. 400-volt tubular
- C₇, C₈, C₉—0.1- μ fd. 400-volt tubular
- C₁₀—0.1- μ fd. 400-volt tubular
- C₁₁—0.5- μ fd. 400-volt tubular
- R₁—5 megohms, $\frac{1}{2}$ watt
- R₂—50,000-ohm potentiometer
- R₃—20,000 ohms, 1 watt
- R₄—50,000 ohms, $\frac{1}{2}$ watt
- R₅—250,000 ohms, $\frac{1}{2}$ watt
- R₆—1- megohm potentiometer
- R₇—2000 ohms, $\frac{1}{2}$ watt
- R₈—50,000 ohms, 1 watt
- CH—500-hy. plate choke
- Coils—See coil table

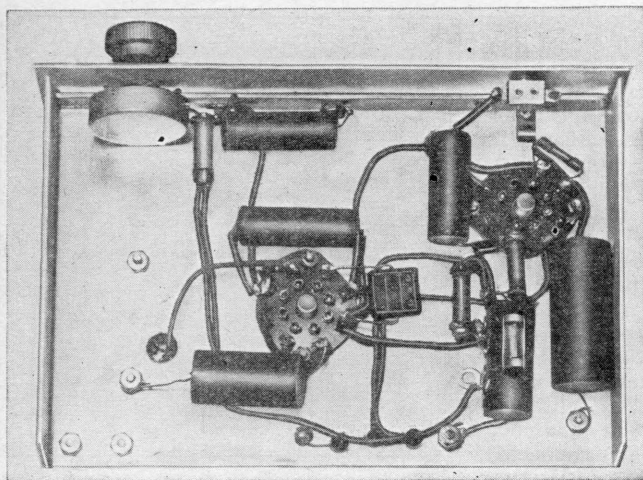

Figure 10. A peek under the standard "Gainer" chassis reveals the regeneration control, phone jack, various by-pass condensers and resistors.

COIL-WINDING TABLE FOR STANDARD REGENERATIVE "GAINER" RECEIVER

160-225 METERS: Wind 70 turns of no. 24 d.s.c. wire on a 1/2-in. diam. form. Connect cathode tap 1/2 turns up from ground end.

70-110 METERS: Wind 36 turns of no. 22 d.s.c. wire on a 1/2-in. diam. form. Connect cathode tap 1/2 turns up from ground end.

32-60 METERS: Wind 21 turns of no. 22 d.s.c. wire on a 1/2-in. diam. form and space-wind the wire over a winding space of 1 3/4 in. Connect cathode tap 1/2 turn up from ground end.

19-30 METERS: Wind 11 turns of no. 22 d.s.c. wire on a 1/2-in. diam. form and space-wind the wire over a winding space of 1 3/4 in. Connect cathode tap 1/2 turn up from ground end. The location of the cathode tap is quite critical on the 19-30 meter coil, and a slight amount of experimenting must sometimes be done in order to find the point where smooth oscillation control is obtained.

10-25 METERS: Wind 5 turns of no. 16 d.s.c. wire on a 1/2-in. diam. form and space-wind the wire over a winding space of 1/2 in. Connect cathode tap 1/3 turn up from ground end. Experiment with cathode tap connecting point until best control of regeneration is secured.

NOTE: This receiver will not cover the broadcast band unless a 350- μ fd. variable condenser is connected in parallel with the 100- μ fd. band setting condenser. A coil which will cover the broadcast band can be made with a 2-inch winding length of no. 28 or 30 d.s.c. or enameled wire on a 1/2-in. diam. form. Connect cathode tap 2 1/2 turns up from ground end.

The total heater drain of the 6S7-G and the 6C5-G is only 0.3 amp. Nearly 100 hours of operation can be obtained from the four standard dry cells, making it possible to use the receiver for portable work when desired. For such work, four 45-volt B batteries can be used for plate supply; the plate current drain is quite low.

If the receiver is to be used only with a.c. power supply, the matter of heater drain is relatively unimportant. In this

WINDING THE COILS

Five tuning coils are needed to cover the amateur bands—160, 80, 40, 20 and 10 meters. These coils are wound on standard 4-prong 1/2-inch diameter coil forms.

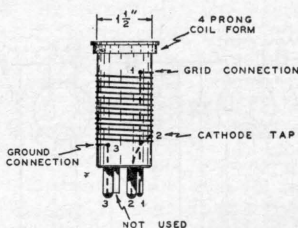

FIGURE 11.

Each coil has three connections: top, bottom and cathode tap. These connections are made to three of the coil prongs; the wires must be soldered into the prongs.

case a 6C6 and 76, or 6J7-G and 6C5-G may be substituted for the 0.15-amp. heater tubes shown in the diagram. These tubes cost less and give identical performance.

The receiver requires an a.c. power supply having three filter chokes and three or four 8- μ fd. filter condensers in order to provide a source of very pure d.c. plate supply. Such a power supply is described in the chapter devoted to *Power Supply Systems*. It should preferably be placed several feet from the receiver.

Operation

Before putting the receiver into operation, the wiring should be carefully checked. For antenna and coupling considerations, refer to data on RK43 receiver just described. An external ground connection should be made to the chassis. The power supply is then connected to the receiver, the tubes permitted to warm up and the regeneration control advanced to the point where a hiss is heard in the headphones. In this con-

dition c.w. telegraph signals can be received; just below this hiss point is the correct setting for reception of weak voice signals. The *bandsetting* condenser is set near minimum capacity for locating the various amateur bands, and the *bandspread* condenser is then tuned to receive the desired signals. If no signals are heard, the difficulty usually can be traced to one or more of the following causes:

- (1) Defective grid condenser.
- (2) Defective grid resistor.
- (3) Defective tube(s).
- (4) Defective regeneration condenser.
- (5) Defective high impedance choke.
- (6) Open circuit in coil or socket connections.
- (7) Short-circuited by-pass condenser.
- (8) Antenna not connected to receiver.
- (9) Incorrect wiring.
- (10) Socket prong broken or bent out of position.
- (11) Cathode tap not soldered to coil winding.
- (12) Short-circuited tuning condenser.
- (13) Excessive antenna coupling.

CONTINUOUS-COVERAGE T.R.F. RECEIVER

This receiver is similar in design to the Standard Regenerative "Gainer", except for the addition of a tuned r.f. stage and the use of metal tubes throughout. The coils are designed to give complete coverage on all wavelengths from 9 to 200 meters, rather than merely covering

the amateur bands. The tuned r.f. stage increases the sensitivity to weak signals and prevents crosstalk from nearby powerful broadcast stations, which sometimes rides in on the short-wave bands on the more simple types of regenerative receivers.

Figure 12. Front view of the t.r.f. amateur receiver. A precision tuning dial drives the bandspread condenser. Regeneration, volume and sensitivity controls are arranged along the lower portion of the panel.

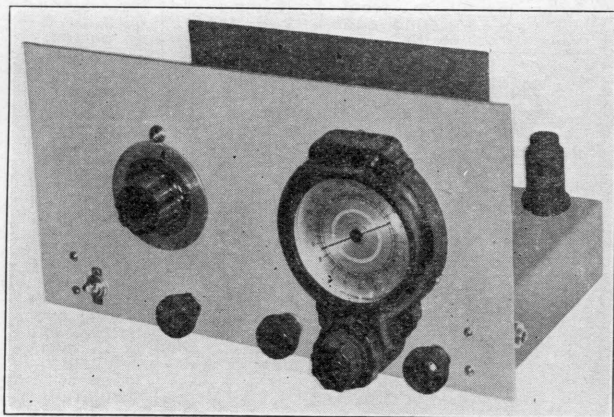

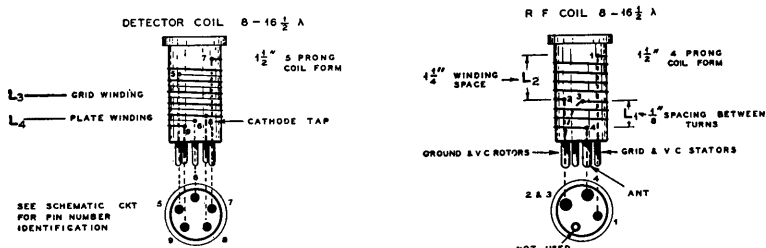

FIGURE 13. 8- TO 16½-METER COIL CONSTRUCTION FOR CONTINUOUS COVERAGE.

The r.f. amplifier has a sensitivity control which consists of a variable resistor in the cathode circuit. This is essential for proper operation of the receiver in locations where interference from powerful nearby stations is troublesome. The receiver is designed for simplicity in construction by using two midget two-gang tuning condensers, separated by a heavy aluminum shield partition. This type of construction gives fairly good isolation between the two tuned circuits. Each coil socket has its grid and ground leads connected to the stators and rotors of its particular band-setting and bandsread tuning condenser

sections. Insulated couplings between the tuning dials and variable condenser shafts prevent the introduction of noise when tuning in the short-wave bands.

Detector and r.f. stage tuned circuits are made to "track" by winding the secondaries of each pair of coils in a similar manner. The coil turns are then slightly pushed together, or spaced more widely, when the circuits are lined up with the receiver under test. The r.f. tuned circuit has an additional 3-to-30- μ fd. trimmer condenser to compensate for the additional circuit capacities in the detector grid circuit. This condenser can be adjusted to a compromise value

CONTINUOUS COVERAGE T. R. F. RECEIVER COIL TABLE

All Coils Wound on 1½" Diameter Forms.

APPROX. RANGE IN METERS	ANT. COIL L ₁	SECONDARY COIL L ₂	PRIMARY COIL L ₃	SECONDARY COIL L ₄	CATHODE TAP ON L ₄
8 to 16	3 turns, spaced 1/8-in. from ground end of L ₂	3½ turns #20 d.s.c. ¾-in. long	2½ turns #24 d.s.c. interwound with L ₄ B+ at bottom	3½ turns #20 d.s.c. ¾-in. long	Tap at 1/3 turn on bottom turn
15½ to 32	5 turns, 1/8-in. from L ₂	7 turns #24 d.s.c. 1½-in. long	3 turns #24 d.s.c. interwound with L ₄	7 turns #24 d.s.c. 1½-in. long	Tap at ½ turn on bottom turn
29 to 62	8 turns, 1/8-in. from L ₂	16 turns #24 d.s.c. 1½-in. long	6 turns #24 d.s.c. interwound with L ₄	16 turns #24 d.s.c. 1½-in. long	Tap at ¾ turn on bottom turn
59 to 107	10 turns, 1/8-in. from L ₂	31 turns #24 d.s.c. 1½-in. long	8 turns #34 d.s.c. interwound with L ₄ at ground end	31 turns #24 d.s.c. 1½-in. long	Tap at 1 turn up from bottom
97 to 215	12 turns, 1/8-in. from L ₂	54 turns #24 d.s.c. 1½-in. long	12 turns #34 d.s.c. wound over bottom end of L ₄ over celluloid layer of insulation	54 turns #24 d.s.c. 1½-in. long	Tap at 1/4 turns up from bottom

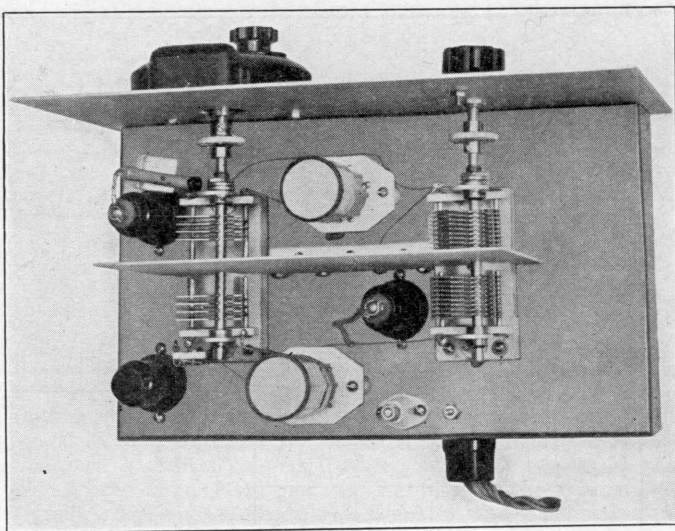

Figure 15. Interior view of the t.r.f. amateur type receiver. The receiver should preferably be housed in a metal container in order to reduce hum pickup.

for all coils without much loss in exact tuning if the coils are carefully wound and spaced before the turns are cemented in place.

Nearly one-half the total number of plates in a 35- μ fd.-per-section variable condenser must be removed to give best bandspread tuning. The number of plates to be removed will depend upon the operator's particular desire for a particular amount of bandspread. Twelve to 15 μ fd. per section gives very good bandspread for the high-frequency bands, but will not cover the 80- and 160-meter amateur bands without resetting the bandsetting condensers. If the receiver is to be used primarily for the longer wavelengths, such as for the 160-meter band, a capacity of approximately 25 μ fd. per section in the bandspread condenser will be more satisfactory.

Resistors and by-pass condensers should be connected directly to the coil and tube socket terminals. All by-pass connections to ground should be made as short as possible, directly to the chassis which serves as a common ground connection. The chassis should be made of zinc or lead coated steel in order that the leads may be soldered to any point on the chassis. The tuning condenser rotor should also be connected to the chassis and each rotor section connected to its proper coil socket. No. 10- or 12-gauge aluminum is suitable for the shield partition and front panel. The partition should extend upward as high as the front panel in order to provide an effective baffle between the two coils. The chassis is 9"x12"x2½". The metal front panel is 13"x9".

NEW "SUPER-GAINER" RECEIVER

Illustrated in figures 16 to 19 is an improved version of the now famous "Super Gainer." It is more selective than the regenerative autodyne receivers previously described.

A 6J8-G serves as first detector and oscillator, and a 6A6 does duty as a

combined second detector and audio stage. The output of the audio stage is sufficient to drive a pair of phones with good volume. For loudspeaker operation, a type 6F6, 42 or similar tube should be transformer-coupled to the output of the receiver.

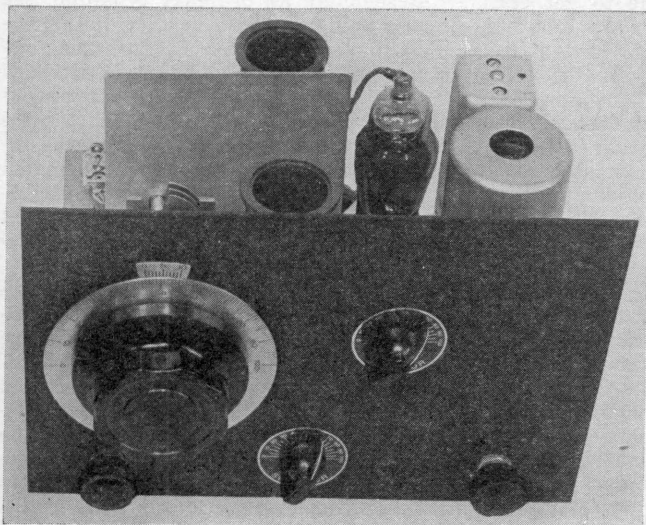

Figure 16. Front panel view of the newest version of the popular "Super-Gainer" two-tube superheterodyne. It is much more selective than an autodyne detector or t.r.f. receiver.

It will be observed from figure 18 that while the receiver is a superheterodyne there is no intermediate amplifier. By utilizing a grid leak type second detector for maximum sensitivity and incorporating regeneration in the second detector to increase the selectivity and increase further the sensitivity, no i.f. stage is required. The regeneration is controllable and serves another purpose in permitting the second detector to oscillate when so desired for the reception of c.w. signals. This obviates the need for a beat oscillator.

The first detector is also regenerative, though it is worked *just below* the point of oscillation. Besides increasing the gain, regeneration at this point reduces image interference. What with use of a regenerative first detector and a relatively high intermediate frequency, image interference is not troublesome even on the highest frequency bands.

For maximum stability and gain, the h.f. oscillator tank is made considerably higher C than the detector coil. By proportioning of the two sections of the gang condenser and use of a .005- μ fd.

Figure 17. Looking down on the "Super-Gainer," the simplest practical superheterodyne. The oscillator section is toward the front panel, the detector to the rear; a shielding partition separates the two.

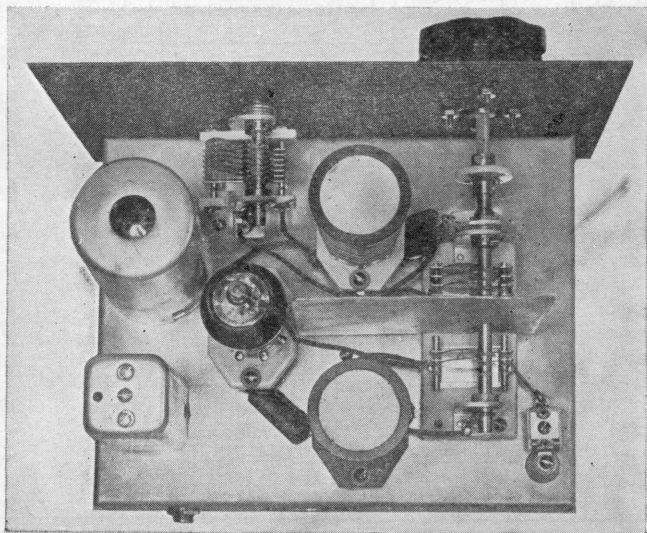

mica padder, it is possible to get each set of coils to track over an amateur band by correct setting of the trimmer and handset condensers on the front panel.

The trimmer on the first detector also allows one to compensate for detuning effects of the antenna, thus enabling one to get the circuits to track exactly. The latter is necessary if full use is to be made of the regenerative gain.

Grid leak detection allows smooth control of regeneration at the intermediate frequency. The second detector is resistance-coupled to the other section of the 6A6 and has an RC filter in its plate lead to cut down on the filtering requirements of the power supply. Any moderately well-filtered supply delivering from 180 to 250 volts and capable of handling 15 ma. will be satisfactory. The RC filter in the second detector plate lead also prevents motorboating which might otherwise occur when an extra audio stage is added.

Resembling an ordinary type dial, the main tuning dial is a vernier dial of the planetary drive type. Because the two-gang main tuning condenser is set back from the front panel in the interest of short leads, a coupling and short piece of shaft are necessary. Though the insulation is not necessary, an insulated coupling of the flexible type is advisable because it is then not necessary to get the dial and condenser mounted in perfect alignment.

The tuning condenser is a 30- μ fd.-per-section two-gang double-spaced mid-get. Be sure to get a tapered plate type and not the straight line capacity (semi-circular) plate type. Plates are removed until the maximum capacity of the detector section is approximately half the maximum capacity of the oscillator section. This can be done by removing plates from the detector section until the rotor-to-stator dielectric spaces are half those in the oscillator section. The condenser shown in the illustration originally had

FIGURE 18. SCHEMATIC WIRING DIAGRAM OF THE "SUPER GAINER."

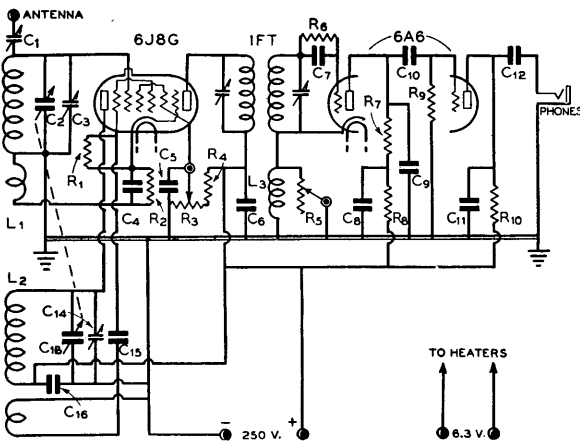

- C₁—3-30- μ fd. mica trimmer
- C₂—15- μ fd. midget variable
- C₃—20- μ fd. midget mica
- C₄—01- μ fd. midget mica
- C₅, C₆—0.1- μ fd. 400-volt tubular

- C₇—0.0005- μ fd. mid-get mica
- C₈—0.5- μ fd. 400-volt tubular
- C₉—0.02- μ fd. mica
- C₁₀—0.1- μ fd. 400-volt tubular
- C₁₁—0.4- μ fd. 400-volt tubular
- C₁₂—0.1- μ fd. 400-

- volt tubular
- C₁₃—30- μ fd. midget variable
- C₁₄—100- μ fd. mid-get variable
- C₁₅—0.001- μ fd. mid-get mica
- C₁₆—0.05- μ fd. mica
- R₁—50,000 ohms, 1/2 watt
- R₂—300 ohms, 1/2 watt
- R₃—50,000-ohm potentiometer
- R₄—25,000 ohms, 1 watt
- R₅—1000-ohm potentiometer
- R₆—10 megohms, 1/2 watt
- R₇—50,000 ohms, 1/2 watt
- R₈—25,000 ohms, 1/2 watt
- R₉—250,000 ohms, 1/2 watt
- R₁₀—50,000 ohms, 1/2 watt
- IFT—1600-kc. i. f. trans.
- Coils—See coil table

Figure 19. Regeneration controls, 6A6 cathode coil, first detector trimmer and various by-pass condensers are found under the "Super-Gainer" chassis. Note how the detector trimmer is tuned by means of an extension shaft. It is set back from the panel to permit shorter leads.

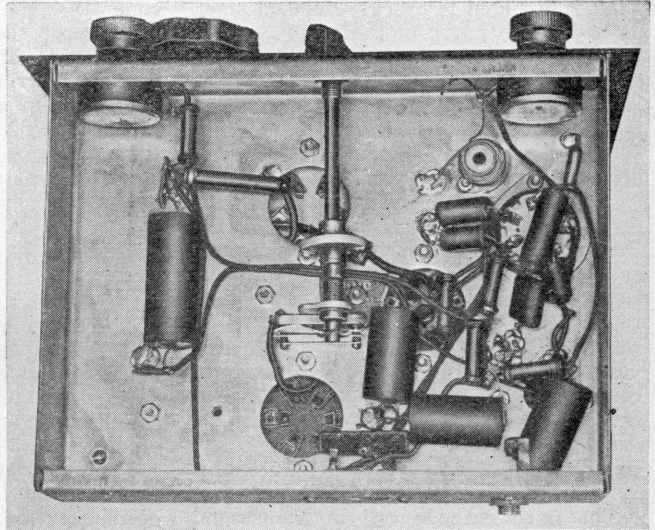

three stator and four rotor plates in each section (six spaces). Plates were removed from the back section until two rotor and two stator plates remained (three spaces).

The .005- μ fd. series padder in the oscillator tank circuit should be of the mica type and be of good quality in order to avoid frequency drift.

Referring to the front panel (figure 16), the top pointer-type knob is the oscillator bandset condenser. The lower pointer is the first detector trimmer. The plain knob at the lower left is the first detector regeneration control, while the knob of the same type at the lower right is the second detector regeneration control.

The layout of the various components can best be done by following the arrangement of figure 17. The shield enclosing the 6A6 is a necessary feature.

The selectivity and gain of the receiver can be increased slightly by the use of an iron core type 1600-kc. intermediate frequency transformer. However, the cost of such a transformer is greater and an air core 1600-kc. i.f.t. will serve almost as well. The transformer need not be air tuned; a transformer with mica trimmers will serve the purpose.

Construction

The receiver is constructed on a standard zinc-plated steel chassis, 7"x9"x2".

SUPER-GAINER COIL TABLE

BAND	OSCILLATOR		DETECTOR	
	1/2" Diam. Plate	Forms Grid	1/2" Diam. Grid	Forms Cathode
160	26 turns	15 turns	85 turns	9 turns
	#22 d.c.c. closewound	#26 d.c.c. closewound	#26 enam. closewound	#26 enam. closewound
80	17 turns	9 turns	40 turns	7 turns
	#20 d.c.c. 1" long	#26 d.c.c. closewound	#24 d.c.c. 1/4" long	#26 d.c.c. closewound
40	10 1/2 turns	6 turns	21 turns	5 turns
	#20 d.c.c. 1" long	#26 d.c.c. closewound	#22 d.c.c. 1/4" long	#26 d.c.c. closewound
20	5 turns	4 1/2 turns	10 turns	3 1/2 turns
	#20 d.c.c. 1" long	#26 d.c.c. closewound	#20 d.c.c. 1/4" long	#26 d.c.c. closewound
10	2 turns	2 3/4 turns	4-1/3 turns	2 turns
	#18 enam. 1/2" long	#26 d.c.c. closewound	#18 enam. 3/4" long	#26 d.c.c. closewound

The front panel is crackle finished steel, 10"x8". A partition of 14 gauge aluminum, 4½" square, is placed between the oscillator and detector sections as illustrated in figure 17. The partition is slotted to fit down over the condenser shaft. The first detector trimmer condenser is mounted below the chassis as shown in figure 19 and tuned by an extension shaft.

Separate ground leads run from each end of the gang condenser to the respective coil sockets and trimmer condenser rotors. The chassis is used as a ground return for all other circuits; by-pass condensers, etc., are soldered directly to the chassis where a ground connection is indicated in the diagram.

The Coils

The fixed cathode coil in the second detector circuit consists of 35 turns of no. 26 d.c.c. wire jumble-wound on a ½" diameter porcelain insulator as a form. The coil is not inductively coupled to the i.f. transformer, but is mounted below the chassis near the 6A6 socket as illustrated in figure 19.

Data on the plug-in high-frequency

coils are given in the coil table. The two sections of the detector coil are wound in *opposite* directions, with no spacing between sections. The two sections of the oscillator coil are wound in the *same* direction with no spacing between sections. Correct polarity, number of turns, direction of turns and connections can be assured by following figure 18 and the coil table.

Tuning

The antenna coupling condenser should be screwed nearly all the way out unless a very short antenna is used. A 75- to 100-foot antenna is preferable to a small indoor antenna; very loose coupling can be used with such an antenna.

The first detector regeneration control should always be kept below the point of oscillation, maximum selectivity and gain occurring just below the point where the detector breaks into oscillation. The regeneration control on the second detector should be adjusted for phone reception in the same manner, but for heterodyne reception of c.w. signals the control should be advanced until the second detector breaks into oscillation.

IMPROVED "ULTRA-GAINER" RECEIVER

The "Ultra-Gainer" receiver described in previous editions of this *Handbook* has been still further improved and modernized by the substitution of an improved mixer circuit, an improved noise limiter, more stable h.f. oscillator and addition of an extra audio stage to permit loud-speaker operation. These improvements make this new model more effective than ever as a communications receiver.

Technical Features

The r.f. amplifier tuning condenser in this new receiver has been ganged with the detector and oscillator tuning condensers to simplify the tuning. The ratio of L to C is made as high as possible so as to obtain high gain on 10 and 20 meters. This model was primarily designed for 10-, 20- and 40-meter operation; however, it can be used to cover nearly all of the 80-meter band, even

with its small two-plate tuning condensers. Ganging the r.f. stage makes it difficult to utilize regeneration in the r.f. amplifier, and the r.f. gain is therefore increased by using a 6J7 sharp cutoff screen-grid tube, rather than a 6K7 variable μ r.f. amplifier tube.

The 6J7 is operated with low bias, high screen voltage and high plate current in order to obtain very high operating mutual conductance. This results in greater r.f. gain than can be obtained from a 6K7. This r.f. amplifier is operated at maximum gain at all times in order to have a very high signal-to-noise ratio. The plate current is at least twice normal value for a 6J7 tube, which will probably shorten the life of the tube to some extent; in spite of this, the 6J7 should be capable of satisfactory operation for at least 800 hours, so that this factor is of no importance when compared with the advantages secured when operating

Figure 20. The newest "Ultra-Gainer" receiver, showing layout of parts on front panel.

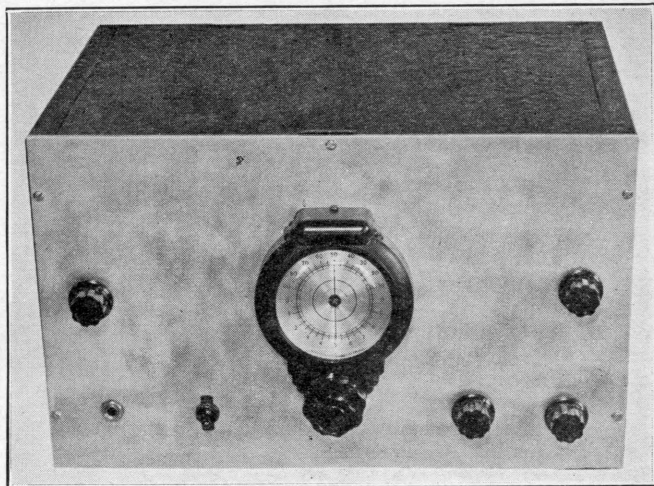

the tube in the manner prescribed. The only serious disadvantage of using a 6J7 with low grid bias is a tendency toward crosstalk if the receiver is operated in the vicinity of a powerful broadcast transmitter.

The r.f. amplifier is capacitively-coupled to the 6J8-G first detector. A 10,000-ohm resistor in series with a 2-mh. r.f. choke provides an effective r.f. impedance for all amateur bands. The semivariable r.f. coupling condenser serves a dual purpose, in that it can also be used to line up the detector tuned circuit. Low bias on the 6J7 tube is obtained by using a 400-ohm resistor, rather than the usual 1500-ohm value recommended for this type of tube. A small mica trimmer condenser is connected across each individual r.f. plug-in coil in order to insure proper tracking for each amateur band.

A 465-kc. crystal filter is incorporated in the i.f. amplifier for the purpose of improving the selectivity for c.w. reception. The volume control for the receiver is located in the cathode circuit of the i.f. amplifier.

The second detector circuit utilizes a 6N7 twin-triode connected as an audio amplifier and regenerative second detector. This regenerative detector provides a beat-oscillator action for c.w. reception and also has a lower hiss-to-signal ratio than when a separate b.f.o. circuit is used. Regeneration is obtained by means of a 75-turn cathode coil, $\frac{1}{2}$ in. diameter, jumble-wound with no. 28 d.s.c.

wire. Regeneration and oscillation are controlled by means of a variable 1,000-ohm resistor in shunt with the cathode coil. Grid leak detection provides good sensitivity and very smooth regeneration in the detector circuit.

The 6J8-G first detector-mixer tube is considerably more sensitive to weak signals than the 6L7 arrangement used in the 1938 model of the Ultra Gainer. The electron-coupled high-frequency oscillator used in the new model is more stable than a triode oscillator as it is practically immune to frequency variations due to line voltage fluctuations.

The noise limiter in the receiver illustrated is more effective than the copper oxide noise limiter used in the previous model of the Ultra Gainer. The operation of the limiter circuit illustrated is explained on page 164 of the preceding chapter. As used in the Ultra Gainer, a delay voltage of approximately 1 volt is about optimum. Bias of this value is obtained for the 84 diodes by bleeding 2.5-ma. d.c. through the midget class-B output transformer T₁ by connecting resistors as illustrated in the diagram. The two resistors will have to be changed accordingly in order to maintain the correct delay bias if the plate supply is much less than 250 volts, or if the midget transformer shows much more or less than 400 ohms d.c. resistance each side of the center tap on the primary. The transformer is of the type designed for portable service, for feeding a 6A6 or 6N7 class-B modulator or amplifier to

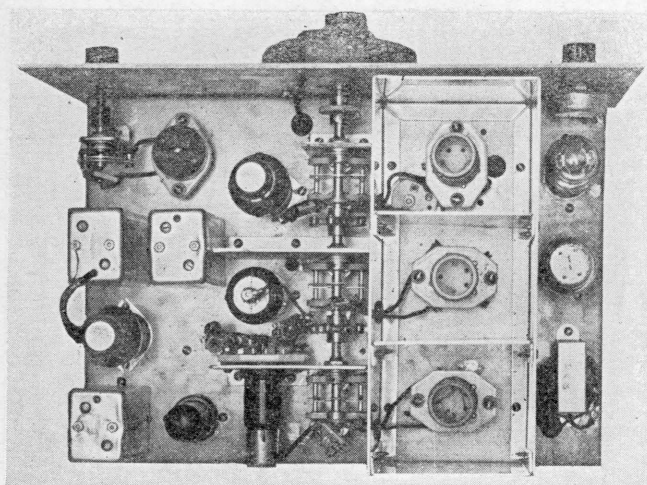

Figure 21. The parts layout of the latest "Ultra Gainer" is similar to the previous model except for a diode type a.f. noise limiter and 41 audio output stage in the space formerly occupied by the noise balancing antenna input circuit. This facilitates conversion of the earlier model to the one illustrated.

a load of between 2500 and 5000 ohms.

Loudspeaker reception of c.w. signals is made highly effective by means of a "Selectosphere" resonant spheroid speaker which peaks around 800 cycles. The use of this speaker provides added selectivity for c.w. and improves the signal-to-noise ratio. An ordinary permanent-magnet-type dynamic loudspeaker can be substituted for phone reception.

The same chassis and panel layout is used as in the previous model of the Ultra Gainer. This simplifies the changing of the earlier model to the improved one shown, for those who have the previous model and want to incorporate the improvements offered in the new receiver. The noise limiter and audio amplifier are added to the chassis to the left of the coil shield can in the space previously occupied by the antenna noise balancer. The antenna noise balancer is not incorporated as part of the receiver in the new model. The new and improved version of noise balancer described on page 161 can be added externally by those troubled with bad power leak interference. It is useful only in bad locations, but in such cases is very much worth while.

Construction

The receiver is built on a zinc-coated metal chassis, 10"x14"x2½". The front panel is 15"x8", of no. 8 aluminum. The tuning coil sockets are mounted on 1½-

in. bushings in order to raise the coils well above the chassis. An aluminum box with two partitions is built around the coils to provide good shielding between stages. This aluminum catacomb is made 5 inches high and about 4 inches wide, with each partition about 3¼ inches wide. This provides wide spacing around the small isolantite plug-in coil forms, with the result that r.f. losses in the shielding are negligible.

The oscillator air-tuning padder condenser is soldered across the oscillator coil socket, which is in the front section of the receiver. The detector coil is in the center section, the r.f. coil in the rear. The ganged tuning condenser is made by mounting three midget variable condensers on three separate vertical aluminum partitions. The mounting holes are made large enough so that the condensers can be lined up accurately before the single-mounting nut is tightened. Flexible couplings are used between sections and to the vernier tuning dial, in order to give smooth action in spite of the many fixed bearing surfaces in the ganged condenser. Excessive friction in the tuning of the ganged condenser may cause backlash in the drive of the tuning dial for c.w. reception.

The r.f. amplifier tube is mounted in a horizontal position so as to secure very short grid and plate leads. The tube socket is mounted on one of the vertical aluminum partitions near the tuning condenser.

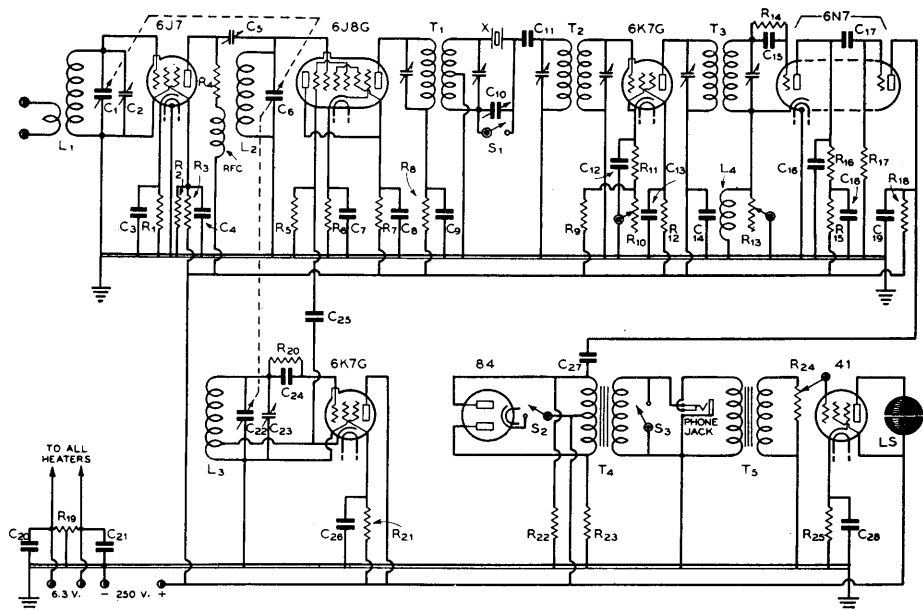

FIGURE 22. SCHEMATIC WIRING DIAGRAM OF LATEST "ULTRA GAINER"

- | | | | |
|---|--|---|---|
| C ₁ —10- μ fd. midget variable | C ₁₉ —.002- μ fd. mica | R ₇ —25,000 ohms, 1/2 watt | R ₂₂ , R ₂₃ —100,000 ohms, 1 watt |
| C ₂ —3-30- μ fd. mica trimmer across each coil | C ₂₀ , C ₂₁ —.01- μ fd. 400-volt tubular | R ₈ —5000 ohms, 1/2 watt | R ₂₄ —1-megohm potentiometer |
| C ₃ —.01- μ fd. 400-volt tubular | C ₂₂ —10- μ fd. midget variable | R ₉ —100,000 ohms, 1 watt | R ₂₅ —400 ohms, 10 watts |
| C ₄ —.02- μ fd. 400-volt tubular | C ₂₃ —25- μ fd. variable air trimmer | R ₁₀ —50,000-ohm potentiometer | S ₁ —Crystal filter on-off switch |
| C ₅ —3-30- μ fd. mica trimmer | C ₂₄ —.00005- μ fd. mica | R ₁₁ —300 ohms, 1/2 watt | S ₂ —Noise silencer on-off switch |
| C ₆ —10- μ fd. midget variable | C ₂₅ —.0001- μ fd. mica | R ₁₂ —100,000 ohms, 1/2 watt | S ₃ —Communications switch |
| C ₇ , C ₈ , C ₉ —.01- μ fd. 400-volt tubular | C ₂₆ —.01- μ fd. 400-volt tubular | R ₁₃ —1000-ohm potentiometer | LS—Spheroidal c.w. loudspeaker |
| C ₁₀ —15- μ fd. phasing condenser | C ₂₇ —25- μ fd. 400-volt tubular | R ₁₄ —10 megohms, 1/2 watt | RFC—2.2-mh., 125-ma. r.f. choke |
| C ₁₁ —3-30- μ fd. mica trimmer | C ₂₈ —25- μ fd. 25-volt tubular | R ₁₅ —25,000 ohms, 1/2 watt | X—465-kc. filter crystal |
| C ₁₂ —0.1- μ fd. 400-volt tubular | R ₁ —400 ohms, 1/2 watt | R ₁₆ —100,000 ohms, 1/2 watt | T ₁ , T ₂ —Xtal input and output i.f. |
| C ₁₃ —.01- μ fd. 400-volt tubular | R ₂ —250,000 ohms, 1/2 watt | R ₁₇ —500,000 ohms, 1/2 watt | T ₃ —465-kc. i.f. trans. |
| C ₁₄ —0.1- μ fd. 400-volt tubular | R ₃ —100,000 ohms, 1/2 watt | R ₁₈ —50,000 ohms, 1/2 watt | T ₄ —Midget class-B output, 6A6-6N7 to class-C stage or magnetic speaker |
| C ₁₅ —.0001- μ fd. mica | R ₄ —10,000 ohms, 1/2 watt | R ₁₉ —50-ohm c.t. resistor | T ₅ —6:1 audio transformer |
| C ₁₆ —.004- μ fd. mica | R ₅ —50,000 ohms, 1/2 watt | R ₂₀ —25,000 ohms, 1/2 watt | Coils—See text |
| C ₁₇ —.01- μ fd. 400-volt tubular | R ₆ —300 ohms, 1/2 watt | R ₂₁ —50,000 ohms, 1/2 watt | |
| C ₁₈ —0.5- μ fd. 400-volt tubular | | | |

COIL TABLE FOR "ULTRA-GAINER" RECEIVER

BAND (METERS)	OSCILLATOR COIL	DETECTOR COIL	R. F. COIL (individual mica trimmers)
10	5 turns, #22 d.s.c. 1" long, 1/8" diam., tapped at 1/2 turns	5 turns, #22 d.s.c. 1" long, 1/8" diam.	5 turns, #22 d.s.c. 1" long, 1/8" diam., tapped at 3/4 turn
20	13 turns, #22 d.s.c. 1" long, 1/8" diam., tapped at 2 turns	13 turns, #22 d.s.c. 7/8" long, 1/8" diam.	13 turns, #22 d.s.c. 7/8" long, 1/8" diam., tapped at one turn
40	26 turns, #22 d.s.c. 1" long, 1/8" diam., tapped at 4 turns	27 turns, #22 d.s.c. 1" long, 1/8" diam.	27 turns, #22 d.s.c. 1" long, 1/8" diam., tapped at 2 turns
80	52 turns, #22 d.s.c. 1 5/8" long, 1/4" diam. tapped at 7 turns	60 turns, #22 d.s.c. 1 3/4" long, 1/4" diam.	60 turns, #22 d.s.c. 1 3/4" long, 1/4" diam., tapped at 4 turns

6N7 Cathode Coil—75 turns, #28 d.s.c., jumble-wound on 1/2" diam. form.

Lining Up the Receiver

An all-wave test oscillator is required for aligning this receiver. The i.f. transformers should first be aligned to the frequency of the quartz crystal, as described in the *Receiver Theory* chapter. The second detector should go into oscillation smoothly as the 1,000-ohm variable resistance is rotated. The i.f. tuning into the second detector should be adjusted so that the latter will give single-signal reception in conjunction with the crystal filter and phasing condenser in the crystal circuit.

If insufficient cathode turns are used, the second detector cannot be made to oscillate; too many turns will cause a detuning effect when adjusting the i.f. transformers, and smooth control of regeneration cannot be secured.

The h.f. circuit alignment is rather difficult unless the signal generator is accurately calibrated. The oscillator padding condenser should be set so that the oscillator will track with the first detector circuit over one of the coil ranges,

preferably the 10-meter band. The r.f. coupling condenser should be adjusted to approximately two-thirds its maximum capacity. The r.f. padding condenser can be adjusted for maximum sensitivity with the particular antennas used for each band. It will be found that coils made as shown in the coil table, with some slight re-spacing of the coil turns before they are cemented into position, will make the tracking very accurate over the narrow amateur bands. The tuning condensers have a low maximum capacity, so that the amateur bands are spread over a large portion of the tuning dial. The additional time involved in originally lining up the coils and condenser in the h.f. circuits is well repaid because the bandsetting condensers then need not be readjusted and tuning can be accomplished with the single dial.

The 10-, 20- and 40-meter coils are wound on small Isolantite coil forms, 1 1/8-in. diameter. The 75-meter coils, which cover a range of from 4.0 to 3.5 megacycles, are wound on ribbed bakelite forms, 1 1/4-in. diameter. The coil chart appears above.

DE LUXE COMMUNICATIONS RECEIVER

Those who have the ability and the facilities for building a de luxe communications receiver will find many features of interest in this ten-tube super-heterodyne. It incorporates a very high gain r.f. amplifier, crystal filter, a very effective noise-silencing circuit and re-

verse-feedback audio amplification. It has an "R" meter for denoting carrier signal strength, a precision single-tuning control, built-in power supply, cast aluminum chassis and shielded plug-in coils which can be mechanically ganged together by means of bakelite strips and

Figure 23. Front view of the de luxe communications receiver.

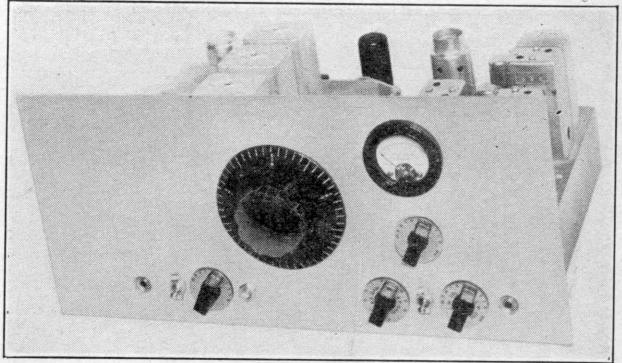

handles for quick coil change when desired.

The r.f. amplifier has a sharp cutoff screen grid tube, operated with low bias and high screen voltage and plate current to obtain maximum signal-to-noise ratio in the front end of the receiver. A standard 6L7 first detector has its injection grid connected to the cathode of a 6K7 power type triode oscillator. The position of the cathode tap on the oscillator coil was selected so that proper injection voltage is provided for each amateur band. Under these conditions, the 6L7 first detector is very efficient for weak signal detection or mixing action.

A 465-kc. quartz crystal filter is built into the circuit between the first detector and first i.f. amplifier. Two stages of i.f. amplification make possible very high selectivity and ample gain to work into a diode second detector. The latter provides a.v.c. voltage for phone reception, second detector action, and is part of the noise-suppression circuit for elimination of automobile ignition interference. A 6R7 serves as a second detector diode and for the first stage of audio amplification. This tube drives a 6L6 audio amplifier which has reverse feedback in the audio stage in order to reduce the hum level and instability of the 6L6.

Bridge-Type R Meter

A separate b.f.o. circuit is incorporated for c.w. reception. For phone reception an R meter is connected in the first detector plate circuit in a *Wheatstone Bridge* arrangement. This meter indicates the relative signal strength, since the plate current of the 6L7 varies in accordance with the a.v.c. voltage; the latter depends upon the strength of the incoming carrier signal. A 1,000-ohm

variable resistor gives a convenient zero-setting adjustment for the R meter scale. For c.w. reception, the a.v.c. voltage is short-circuited to ground and the R meter indication is meaningless in this condition.

Noise Silencer

A separate type 1-v. diode tube is incorporated in the noise-silencing circuit of the type developed by *Dickert*. This circuit is very effective for reducing automobile ignition noise and is entirely automatic in action. It will follow a slowly fading signal, and can be used for either phone or c.w. Its effectiveness can be greatly increased for c.w. reception by short-circuiting one of the resistors in the 1-v. tube circuit. This connection tends to operate on the modulated sidebands of a phone signal, so that for good quality phone reception the switch should be in the "open" position. The additional diode acts as a short circuit across the audio amplifier for sharp peaks of noise which have an amplitude greater than that of the incoming signal.

The time constants of the 1-v. circuit are chosen so that the diode acts as a very high impedance shunt across the audio circuit except during the very short time interval of a high noise pulse. The plate circuit of the 1-v. tube has a large time constant, and thus its potential remains at the average value determined by the rectified incoming carrier signal. The cathode bias of this tube has a short time constant and is connected into the a.v.c. circuit so that its instantaneous value depends upon the peak signal which is present, such as that of the noise pulse. This causes the 1-v. diode to act as a short circuit to the

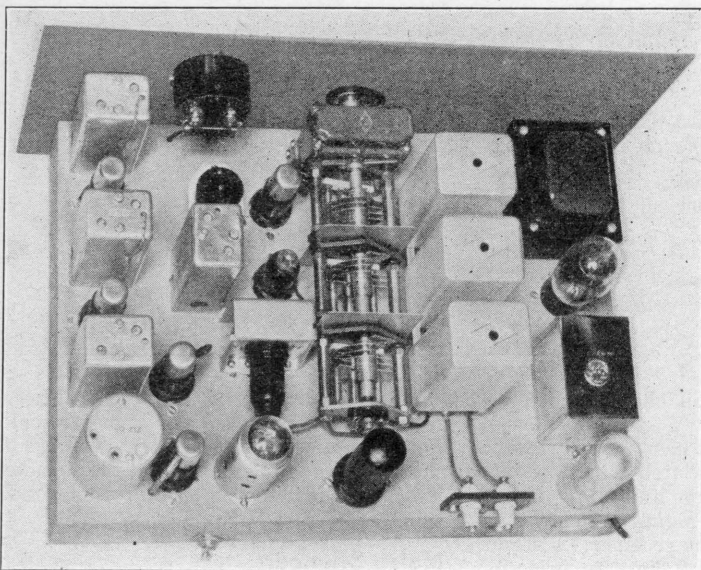

Figure 24—Layout of parts, showing individually shielded plug-in coils.

audio amplifier and its instantaneous bias is more negative than the plate potential. However, the plate potential is a function of the a.v.c. voltage; it, therefore, is entirely automatic and needs no readjustment for different signals when tuning the receiver.

The audio volume control is connected in the grid circuit of the 6R7 audio triode tube. The jack for headphone reception is located in the plate circuit of the 6R7, and when the headphones are plugged in, the loud-speaker is disconnected from the circuit. The 6L6 gives additional amplification for loud-

speaker reception. The reverse-feedback circuit consists of a 0.1- μ fd. condenser in series with a 50,000-ohm resistor connected from the plate of the 6L6 tube to the return grid circuit of the audio transformer. A 5,000-ohm resistor from this point to ground provides the out-of-phase voltage in the grid circuit.

An external noise-balancing input coupler may be added if the receiver is to be used where power leak noise is bad.

Construction

The receiver is built on a cast aluminum chassis, 12"x17"x2½". The front

COIL TABLE FOR DE LUXE COMMUNICATIONS RECEIVER

BAND (METERS)	ANTENNA COILS	DETECTOR AND R. F. COILS	OSCILLATOR COILS
10	2 turns c.t.	5 turns, #22 d.c.c., 1" long	5 turns, #22 d.c.c., 1" long, tapped at 1 turn
20	3 turns c.t.	12 turns, #22 d.c.c., 1" long	12 turns, #22 d.c.c., 1" long, tapped at 2 turns
40	6 turns c.t.	23 turns, #22 d.c.c., closewound	22 turns, #22 d.c.c., closewound, tapped at 3½ turns
80	10 turns c.t.	50 turns, #24 d.s.c., closewound	44 turns, #24 d.s.c., closewound, tapped at 6 turns
160	12 turns c.t.	108 turns, #28 enam., closewound	85 turns, #28 enam., closewound, tapped at 9 turns

panel is $8\frac{3}{4}$ "x19"x $1\frac{1}{4}$ " Dural, for standard relay-rack mounting. This very heavy construction insures good rigidity for elimination of detuning effects caused by touching the front panel or when making tuning adjustments. A standard three-gang tuning condenser and vernier dial assembly is mounted in the center of the chassis, with the tubes on one side and the individually-shielded plug-in coils on the other. The oscillator tube and tuned circuit is nearest the front panel, while the r.f. circuit and horizontally-mounted r.f. amplifier tube are toward the rear of the chassis. The power supply is mounted on one end, with one of the two filter chokes mounted below the chassis. An external permanent-magnet dynamic speaker is needed for loud-speaker reception. The first i.f. transformer is mounted near the first detector and directly in front of it (near the R meter) is the quartz crystal, which connects in turn to the i.f. transformer nearest the front panel. The b.f.o. coil is at the far rear of the chassis and an external vernier adjustment for the b.f.o. frequency is controlled from the front panel by means of a long bakelite ex-

tension shaft to a 25- μ fd. midget variable condenser under the chassis directly below the b.f.o. transformer.

The shielded coil assembly plugs into three individual isolantite sockets which are mounted on two $\frac{1}{4}$ -in. square brass rods, raised approximately one inch above the chassis by means of brass bushings. The 3- to 30- μ fd. trimmer condensers are mounted on top of the individual coil forms and the condensers are adjusted by means of a bakelite rod through the $\frac{1}{4}$ -in. holes which are drilled into the top of each coil shield can. Individual trimmer condensers for each coil make possible an accurate alignment for each amateur band.

The coils are wound on $1\frac{1}{2}$ -in. diameter forms, which have a rectangular moulded base with prongs for plugging the units into the sockets. The coil table appears here.

Adjustments

The lining-up adjustments of this receiver are the same as those described earlier in this chapter for the *Ultra-Gainer Receiver*.

Special Purpose Receivers

(See chapter 16 also.)

SUPERSELECTIVE PHONE RECEIVER

This receiver was designed for the amateur who is interested primarily in QRM-free phone reception on the crowded 20- and 75-meter phone bands. While the receiver will not separate two stations so close that they are practically on the same channel, the 12 tuned circuits in the 465-kc. i.f. amplifier provide as high a degree of selectivity as can be used for voice reception. The selectivity curve is more square topped than that of a series crystal filter, and though the "skirts" of the curve are not so wide, there is less attenuation of voice frequency side bands.

The i.f. transformers are of the permeability-tuned iron core type, and have a high Q. Twelve high-Q circuits can be made to provide a very narrow, flat-topped pass band at 465 kc.

Though six i.f. transformers are used, it will be noted that the receiver actually has only two i.f. stages. The two 6K7's provide all the gain that is needed; the

extra transformers are incorporated in the interests of selectivity. The first stage runs at high gain in order to provide a satisfactory swing on the R meter. The second stage has less gain due to high cathode bias, provided to avoid any tendency toward oscillation. Two stages of iron core i.f. running wide open have so much gain that special precautions are necessary if oscillation is to be avoided; for that reason, the second i.f. stage in this receiver is run at slightly reduced gain.

The front end of the receiver starts in with a regenerative r.f. stage. A 6J7 sharp cutoff tube provides the best signal-to-noise ratio and the most gain, but trouble may be experienced due to cross-talk if any powerful amateur phones or broadcast stations are close by. In the latter event, a 6K7 can be substituted with a slight loss in gain and signal-to-noise ratio.

A 6J8-G mixer is driven by a 6F6

Figure 26. Designed primarily for highly selective reception of phone signals, this receiver also works fine on c.w. Twelve tuned circuits in the i.f. amplifier give a very narrow, flat-topped response curve without the wide "skirts" common to crystal filter receivers having the conventional number of tuned i.f. circuits.

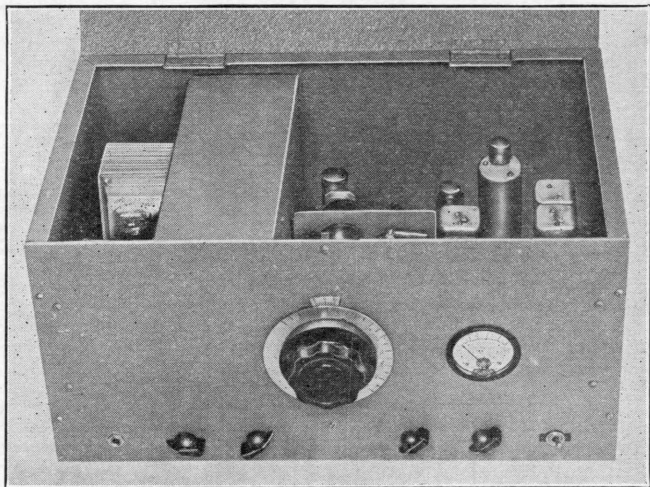

high-frequency oscillator. The combination provides high conversion gain with a low hiss level on all the amateur bands.

A 6H6 acts as combined noise suppressor, second detector and a.v.c. tube. The noise silencing action is very effective

in reducing automobile ignition noise and similar types of interference.

A beat-frequency oscillator utilizing a 6C5 permits reception of c.w. signals, and the performance of the receiver on c.w. is highly gratifying. However, it

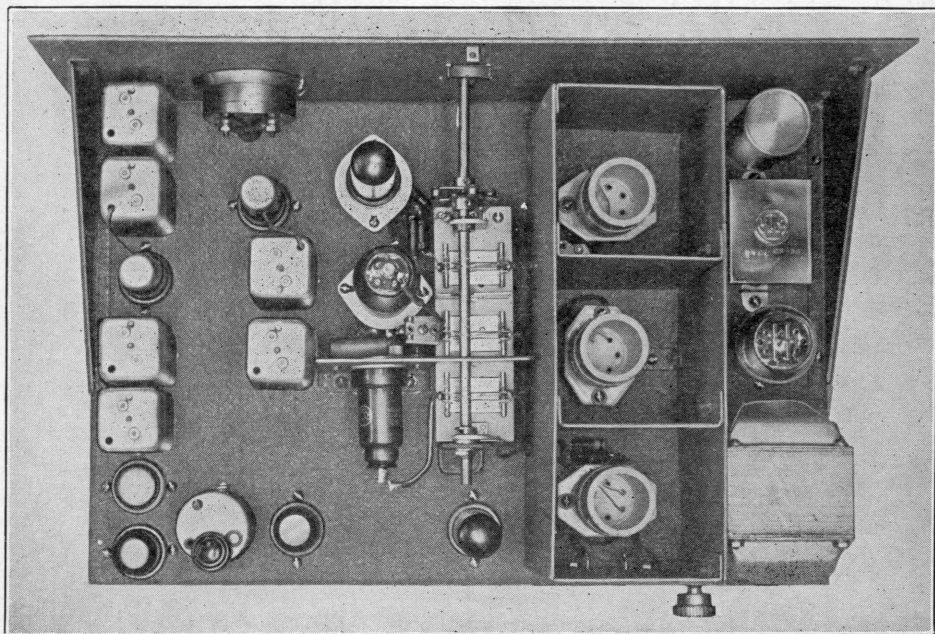

Figure 27. Arrangement of components in the superselective phone receiver is illustrated here. The h.f. oscillator compartment is the one farthest from the power transformer; this is necessary to minimize "warm up" drift.

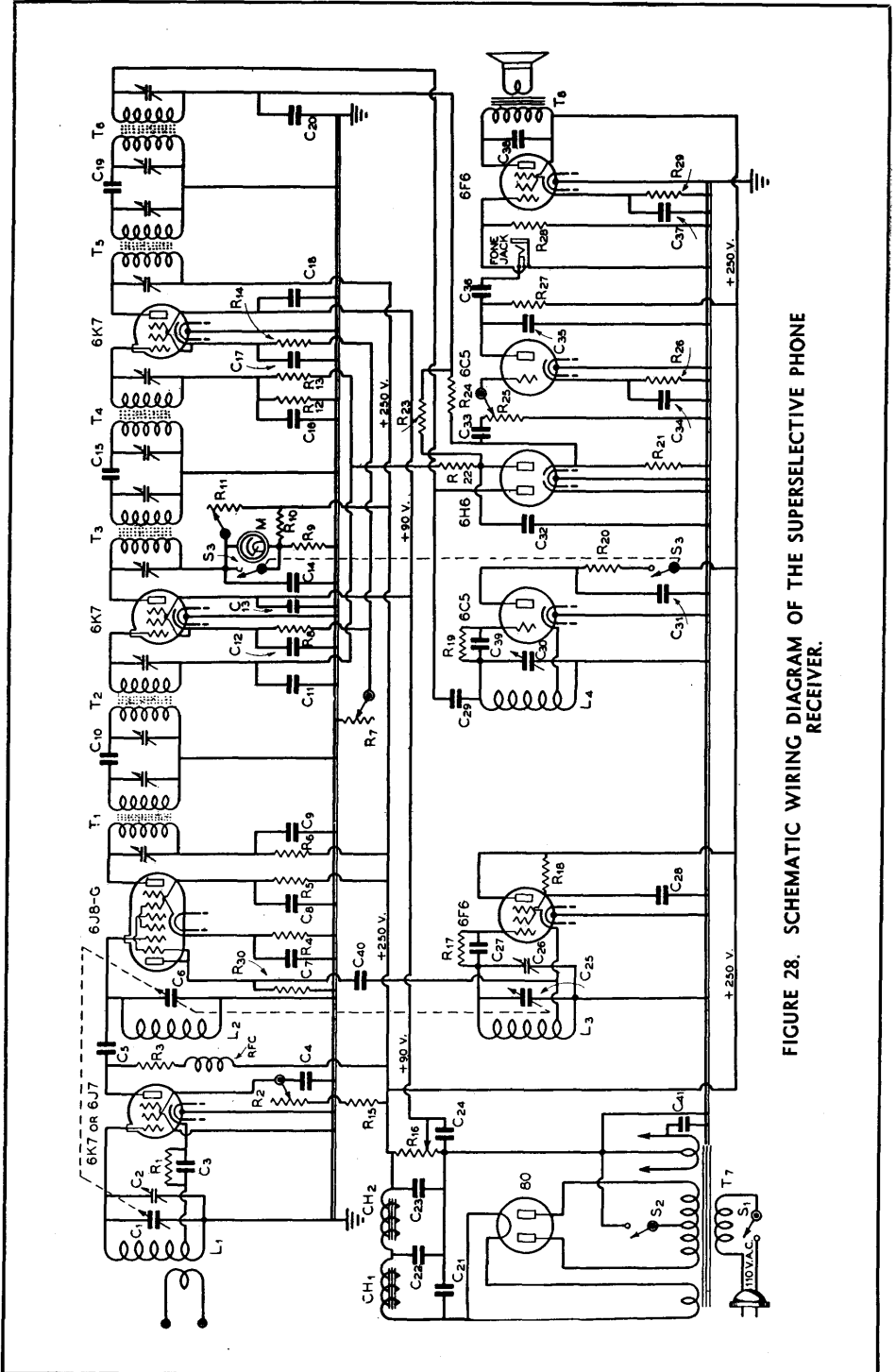

FIGURE 28. SCHEMATIC WIRING DIAGRAM OF THE SUPERSELECTIVE PHONE RECEIVER.

performs no better on c.w. than some of the receivers previously described in this chapter; the ability of the receiver to dig readable phone signals out of the QRM is the receiver's chief, but very worthwhile, claim to distinction.

The audio output of the receiver is sufficient to drive a loud-speaker to good room volume. However, the phone man with "tin ears" may find a little more audio gain desirable. This can be provided simply by adding a 3-1 audio transformer for coupling between the 6C5 and 6F6 audio stages. If transformer coupling is used, an RC decoupling filter consisting of a 50,000-ohm resistor and 0.5- μ fd. condenser will be necessary in the B-plus lead to the 6C5 in order to prevent motorboating.

The gang tuning condenser permits single dial tuning. For optimum adjustment of regeneration in the r.f. stage, a trimmer is provided across the r.f. coil. The gang condenser was originally 20 μ fd. per section, double spaced. One rotor and one stator plate were removed from each section, leaving a maximum capacity of a little less than 15 μ fd. per section. This is just sufficient to cover the 160-meter phone band, but not quite sufficient to cover the extreme low-frequency portion of the 80-meter c.w. band. All other bands are covered completely. The two speed vernier dial tends to spread out the tuning even on the crowded 20-meter phone band.

Referring to figure 26, the front panel controls are left to right: r.f. regenera-

FIGURE 28. CONSTANTS FOR THE SCHEMATIC WIRING DIAGRAM OF THE SUPER-SELECTIVE PHONE RECEIVER.

<p>C₁—15-μfd. midget variable</p> <p>C₂—25-μfd. midget variable</p> <p>C₃—.005-μfd. mica</p> <p>C₄—.02-μfd. 400-volt tubular</p> <p>C₅—3-30-μfd. mica trimmer</p> <p>C₆—15-μfd. midget variable</p> <p>C₇—.05-μfd. 200-volt tubular</p> <p>C₈—.01-μfd. 400-volt tubular</p> <p>C₉—.01-μfd. 400-volt tubular</p> <p>C₁₀—3-μfd. coupling capacity</p> <p>C₁₁—.02-μfd. 400-volt tubular</p> <p>C₁₂—0.1-μfd. 400-volt tubular</p> <p>C₁₃—.01-μfd. 400-volt tubular</p> <p>C₁₄—.02-μfd. 400-volt tubular</p> <p>C₁₅—3-μfd. coupling capacity</p> <p>C₁₆—.02-μfd. 400-volt tubular</p> <p>C₁₇—0.1-μfd. 400-volt tubular</p> <p>C₁₈—.01-μfd. 400-volt tubular</p> <p>C₁₉—3-μfd. coupling capacity</p>	<p>C₂₀—.0001-μfd. mica</p> <p>C₂₁—4-μfd. 450-volt electrolytic</p> <p>C₂₂, C₂₃, C₂₄—8-μfd. 450-volt electrolytics</p> <p>C₂₅—15-μfd. midget variable</p> <p>C₂₆—25-μfd. midget variable</p> <p>C₂₇—.0001-μfd. mica</p> <p>C₂₈—.005-μfd. mica</p> <p>C₂₉—2-μfd. b.f.o. coupling condenser</p> <p>C₃₀—B.f.o. frequency trimmer</p> <p>C₃₁—.01-μfd. 400-volt tubular</p> <p>C₃₂—1.0-μfd. 400-volt tubular</p> <p>C₃₃—.02-μfd. 400-volt tubular</p> <p>C₃₄—1.0-μfd. 400-volt tubular</p> <p>C₃₅—.001-μfd. 400-volt tubular</p> <p>C₃₆—0.1-μfd. 400-volt tubular</p> <p>C₃₇—10-μfd. 25-volt by-pass</p> <p>C₃₈—.02-μfd. 400-volt tubular</p> <p>C₃₉—.0001-μfd. mica</p> <p>C₄₀—.0001-μfd. mica</p> <p>C₄₁—.01-μfd. 400-volt tubular</p> <p>R₁—500 ohms, 1/2 watt</p>	<p>R₂—50,000-ohm pot.</p> <p>R₃—10,000 ohms, 1/2 watt</p> <p>R₄—500 ohms, 1/2 watt</p> <p>R₅—20,000 ohms, 1/2 watt</p> <p>R₆—2000 ohms, 1/2 watt</p> <p>R₇—25,000-ohm pot.</p> <p>R₈—300 ohms, 1/2 watt</p> <p>R₉—100,000 ohms, 2 watts</p> <p>R₁₀—1000 ohms, 1 watt</p> <p>R₁₁—2000-ohm rheostat</p> <p>R₁₂—1 megohm, 1/2 watt</p> <p>R₁₃—1 megohm, 1/2 watt</p> <p>R₁₄—5000 ohms, 1/2 watt</p> <p>R₁₅—25,000 ohms, 1 watt</p> <p>R₁₆—20,000-ohm 50-watt voltage divider</p> <p>R₁₇—25,000 ohms, 1/2 watt</p> <p>R₁₈—50,000 ohms, 1/2 watt</p> <p>R₁₉—50,000 ohms, 1/2 watt</p> <p>R₂₀—100,000 ohms, 1/2 watt</p> <p>R₂₁—500,000 ohms, 1/2 watt</p> <p>R₂₂, R₂₃—1 megohm, 1/2 watt</p> <p>R₂₄—50,000 ohms, 1/2 watt</p> <p>R₂₅—500,000-ohm pot.</p> <p>R₂₆—2000 ohms, 1 watt</p> <p>R₂₇—100,000 ohms, 1 watt</p> <p>R₂₈—250,000 ohms, 1/2 watt</p> <p>R₂₉—400 ohms, 10 watts</p> <p>Coils—See text</p> <p>RFC—2 1/2-mh., 125-ma. choke</p> <p>IF transformers—See text</p> <p>M—0-1 d.c. milliammeter</p> <p>S₁—A.c. line switch</p> <p>S₂—Communications switch</p> <p>S₃—D.p.s.t. b.f.o. and "R" meter switch</p> <p>T₁—700 v. c.t., 85 ma.; 6.3 v., 3.3 a.; 5 v., 2 a.</p> <p>T₂—Pentode-to-voice coil output transformer</p> <p>CH₁—12-hy., 85-ma. choke</p> <p>CH₂—1500-ohm spkr. field</p>
--	---	--

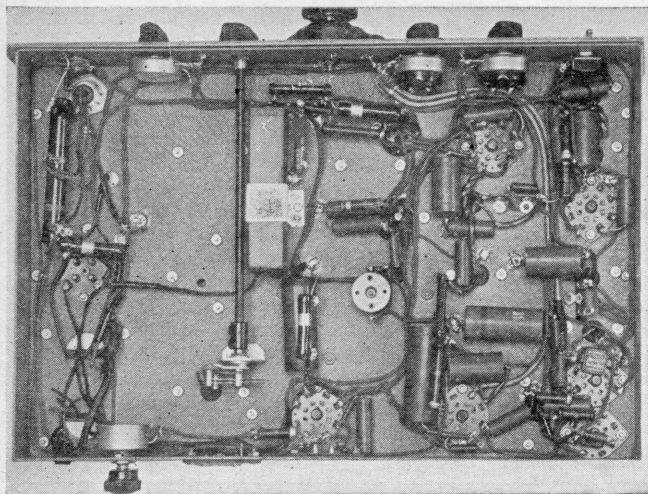

Figure 29. Under chassis view of the superselective phone receiver. Note how the r.f. trimmer condenser is driven by means of an extension shaft. The lone potentiometer appearing on the back of the chassis should be ignored; it was not used in the final version of the receiver.

tion, r.f. trimmer, a.f. volume and a.c. on-off switch, i.f. sensitivity with a.v.c. on-off switch, and b.f.o. on-off switch.

Construction

The receiver is constructed on a steel

chassis 11"x17"x2½". The front panel measures 9"x18", and is of ⅛-in. steel. The can used for a coil shield measures 10"x6"x3½". Two partitions are made from 14-gauge aluminum and placed as illustrated in figure 27. The compartment nearest the front panel houses the

COIL DATA FOR SIX I.F.T. PHONE RECEIVER

BAND	R. F.	DETECTOR	OSCILLATOR
10	4 turns, #20 d.c.c., ¾" long tapped at ½ turn	4 turns, #20 d.c.c., ¾" long	4 turns, #20 d.c.c., ¾" long
	Ant. Coil—2 turns, #24 6 turns, #20 d.c.c., 1" long tapped at ¾ turn		tapped at 1½ turns 6 turns, #20 d.c.c., 1" long
20	shunt sec. with 50-μfd. mica	shunt sec. with 50-μfd. mica	tapped at 2½ turns
	Ant. Coil—3 turns, #24 21 turns, #20 d.c.c., 1" long tapped at ½ turn		shunt sec. with 50-μfd. mica
40	Ant. Coil—3 turns, #24 21 turns, #20 d.c.c., 1" long	21 turns, #20 d.c.c., 1" long	19 turns, #20 d.c.c., 1" long
	Ant. Coil—3 turns, #24 41 turns, #24 d.c.c., 1¼" long tapped at 1 turn		tapped at 4 turns
75	Ant. Coil—4 turns, #24 85 turns, #28 enam., 1¼" long	41 turns, #24 d.c.c., 1¼" long	32 turns, #24 d.c.c., 1" long
	tapped at 2 turns		tapped at 6 turns
160	Ant. Coil—8 turns, #32 d.s.c.	85 turns, #28 enam., 1¼" long	60 turns, #28 enam., 0.9" long
	tapped at 8 turns		tapped at 8 turns

All coils 1½" in diameter. H.F. coils on ceramic forms.

h.f. oscillator, the center compartment the detector and the back compartment the regenerative r.f. stage. The correct layout of the various components is illustrated in the photographs.

Alignment

The performance of this receiver depends so much upon correct alignment of the i.f. transformers that, if possible, the initial adjustment should be done with the assistance of an oscilloscope. However, the job can be done simply by means of an alignment oscillator and output meter if one has the patience. The transformers must first be individually coupled to the oscillator to get them

in rough alignment, and then, with the line-up oscillator connected to the front end of the amplifier, touched up one at a time, again and again to get all six of them "on the nose." Remember that the R meter is in the first r.f. stage and, therefore, cannot be used as an alignment meter except for adjustment of the first two i.f. transformers. Incidentally, the R meter reads in a *forward* direction when wired as shown and, therefore, need not be mounted upside down.

Coil data on coils for all bands from 10 to 160 meters appear in the coil table. The specifications should be followed very carefully if the coils are to track properly.

SUPERSENSITIVE 10-20 M. PHONE RECEIVER

The receiver illustrated in figures 30, 32 and 33 was designed and built by Richard Heinrich, W6DWR, for reception of extremely weak 10- and 20-meter signals that would be lost on an ordinary receiver. Its effectiveness is borne out by the fact that the receiver has pulled in readable 10-meter phone signals that were audible only as weak beat note carriers on two of the best commercially-built communications receivers on the market.

The high degree of sensitivity exhibited by the receiver at these frequencies is due largely to the use of two stages

of acorn r.f. amplification. The first stage is a 954 sharp-cutoff pentode running at full gain all the time. The second r.f. stage uses a 956 remote-cutoff pentode with variable gain control.

A 6F6 high-frequency oscillator, delivering more power than the customary 6K7 or 6J7 oscillator, is used to feed the injector grid of the 6L7 mixer. When sufficient oscillator voltage is supplied to the injector grid, a 6L7 gives excellent conversion gain with very low hiss, which means that the signal-to-noise ratio will be good.

Two stages of 1,600-kc. i.f. give moder-

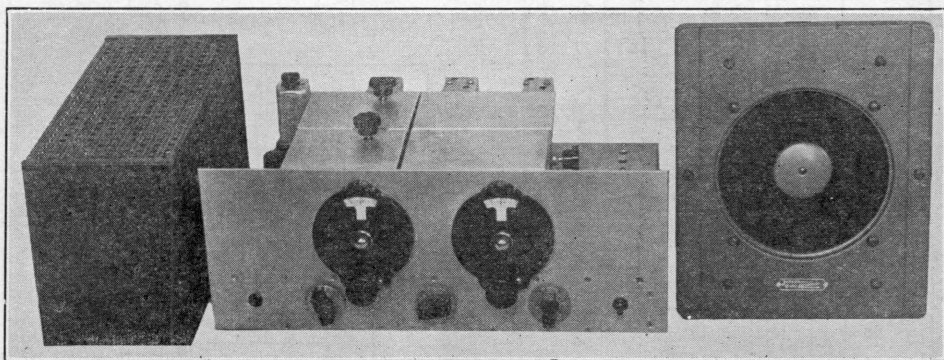

Figure 30. This receiver will bring in many 10-meter and a worthwhile number of 20-meter signals that are not audible on most communications receivers. It uses two stages of pre-selection utilizing acorn tubes. To reduce hum and heating effects, the power supply is made external.

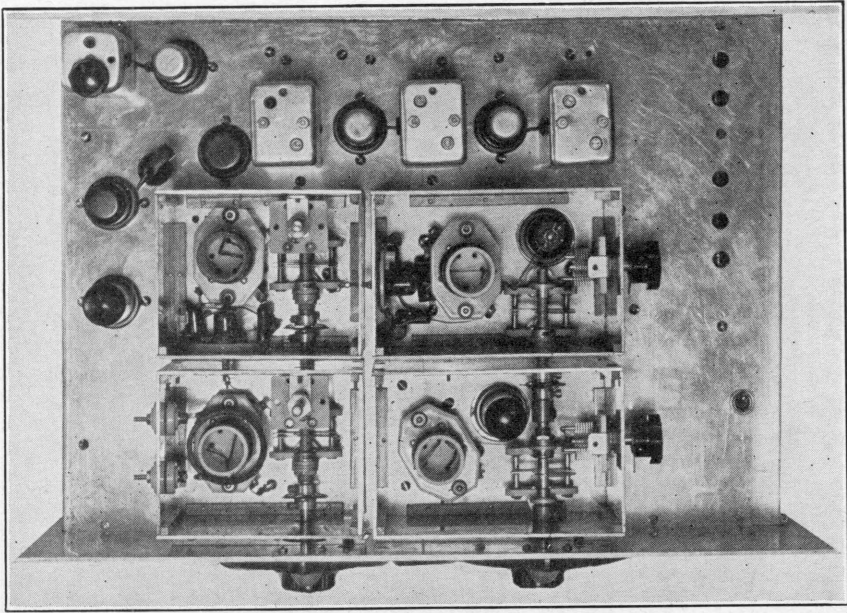

Figure 32. Top view of the supersensitive 10-20 meter receiver, with r.f. compartment lids removed to show arrangement of components in the high-frequency stages. Note method of link coupling the antenna to the first r.f. stage coil.

ate gain and selectivity. Three air-tuned iron-core 1,600-kc. i.f. transformers are used, the last one designed for working into a low impedance (diode) load. The two stages of signal frequency (high-frequency r.f.) amplification and use of

1,600 kc. as the intermediate frequency eliminate every trace of image interference even on the 10-meter band. Greater adjacent channel selectivity could be obtained by using 465-kc. i.f. transformers, but image interference

FIGURE 31. VALUES OF COMPONENTS IN SUPERSENSITIVE 10-20 METER RECEIVER.

C ₁ —15- μ fd. midget variable	C ₁₃ —0.006- μ fd. mica elect.	R ₉ —50,000 ohms, 1 watt	T ₁ —700 v.c.t., 100 ma.; 6.3 v., 4 a.; 5 v., 3a.
C ₂ —20- μ fd. air padder	C ₁₄ —8- μ fd. 450-volt elect.	R ₁₀ —250,000 ohms, 1/2 watt	T ₂ —Pentode-to-voice coil output trans.
C ₃ —50- μ fd. air padder	C ₁₅ —16- μ fd. 450-volt elect.	R ₁₁ —300 ohms, 1/2 watt	IFT _{1, 2, 3} —1600 - kc. iron-core i.f. trans.
C ₄ —0.005- μ fd. mica	C ₁₆ —8- μ fd. 450-volt elect.	R ₁₂ —250,000 ohms, 1/2 watt	S ₁ —Noise silencer selector switch
C ₅ —0.1- μ fd. 600-volt tubular	R ₁ —1500 ohms, 1/2 watt	R ₁₃ —100,000 ohms, 1 watt	S ₂ —A.c. line on-off switch
C ₆ —0.001- μ fd. mica	R ₂ —5000 ohms, 1/2 watt	R ₁₄ —400 ohms, 3 watts	S ₃ —Communications switch
C ₇ —0.1- μ fd. 400-volt tubular	R ₃ —50,000-ohm pot.	R ₁₅ —100,000-ohm pot.	S ₄ —B.f.o. on-off switch
C ₈ —1- to 2- μ fd. coupling condenser	R ₄ —450 ohms, 1/2 watt	R ₁₆ —80,000 ohms, 1/2 watt	Coils—See coil table
C ₉ —0.5- μ fd. 400-volt tubular	R ₅ —600 ohms, 1/2 watt	R ₁₇ —1 megohm, 1/2 watt	L ₅ —1600-kc. b.f.o. trans.
C ₁₀ —0.00005- μ fd. mica	R ₆ —50,000 ohms, 1/2 watt	R ₁₈ —20,000-ohm 50-watt bleeder resistor	CH ₁ CH ₂ —30-hy. 100-ma. chokes
C ₁₁ —1.0- μ fd. 400-volt tubular	R ₇ —10,000 ohms, 3 watts		
C ₁₂ —25- μ fd. 25-volt tubular	R ₈ —20,000 ohms, 3 watts		

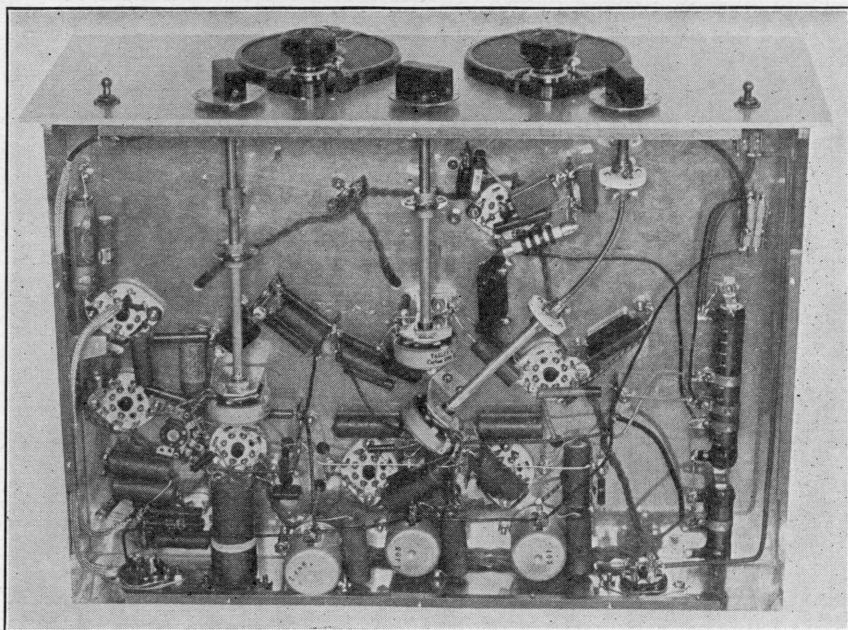

Figure 33. Underneath the supersensitive 10-20 meter receiver. Note the large number of decoupling filter units, such as r.f. chokes, by-pass condensers and resistors.

would then be present even though not to an objectional degree. The higher image ratio provided by the 1,600-kc. transformers seemed more desirable than the slightly greater adjacent channel selectivity offered by 465-kc. transformers.

The 6H6 noise silencer is of the popular Dick6 type, serving also as a.v.c. tube and second detector. It effectively cuts auto ignition and similar QRM to a very low value.

Two stages of audio amplification provide all the loud-speaker volume one can use, and provision is made for plugging a pair of phones into the first audio stage.

A separate power pack is used with the receiver as illustrated in figure 30. The speaker is of the permanent magnet dynamic type.

Construction

The main chassis is of 12-gauge aluminum and measures 17"x12"x2½". The aluminum shield cans enclosing the r.f. stages measure 4½" long by 4" high by 3½" wide. The two aluminum cans shielding the oscillator and detector

stages measure 5½" long by 4" high by 3½" wide. All insulation in the high-frequency r.f. circuits is Isolantite. These four aluminum cans are insulated from the chassis and each other. Each can is grounded to the main chassis at *one point only*. To isolate the stages further, individual tuning condensers are ganged together by means of insulated couplings to make two-gang condensers in which the rotor is not common. As will be noticed in the diagram, every screen and plate return lead is well isolated by means of an r.f. choke or RC filter. Especially good shielding and bypassing are required when two high gain r.f. stages are used at 10 or 20 meters.

As the receiver will effectively get down to the "atmospheric noise level" on 10 and 20 meters, it is important that a good antenna be used in order to get the best results. A resonant antenna, preferably of the directional type, will allow one to realize the full capabilities of this receiver.

Some experimenting with the various controls will be required before one can obtain maximum performance; it is necessary to get the "feel" of the receiver before one knows how to adjust the r.f.,

SUPERSENSITIVE 10-20 M. RECEIVER COIL TABLE

BAND	1st R. F. GRID	2nd R. F. GRID	1st DET. GRID	H. F. OSCILLATOR
10	5½ turns #20 enam. ⅝" long	5¼ turns #20 enam. ⅝" long Interwound primary of 3½ turns #32 d.s.c.	4½ turns #20 enam. ⅝" long Interwound primary of 3½ turns #32 d.s.c.	4 turns #20 enam. ⅝" long Tapped at 2 turns from grounded end
20	13½ turns #22 enam. 1" long	13½ turns #22 enam. 1" long Interwound primary of 4½ turns #32 d.s.c.	11 turns #22 enam. 1" long Interwound primary of 5½ turns #32 d.s.c.	10 turns #22 enam. 1" long Tapped at 4 turns from grounded end

All coils on Isolantite forms 1⅛" in diameter. Antenna coil consists of 2 turns of hookup wire about 1½" diam. through which the 1st r.f. coil plugs into its socket.

i.f. and a.f. gain controls for best performance.

It is very important that the r.f. leads be kept as short as possible. Considerable time and effort were spent in work-

ing out the best physical layout, an arrangement which permitted the shortest r.f. leads. For this reason, it is advisable to adhere to the physical layout of the model illustrated in the three photographs.

A 5-METER SUPER GAINER

Line-stabilized and crystal-controlled transmitters in the u.h.f. region have made it possible to use fairly selective superheterodyne receivers with as much success as on the lower frequencies. A good noise limiter system to suppress automobile ignition interference makes this type of receiver considerably more desirable than a superregenerative type because of better selectivity. A superheterodyne receiver cannot easily be made which is less subject to auto ignition QRM than in the case of a good superregenerative receiver. The latter has an objectionable hiss which is not present in the superheterodyne receiver. The main disadvantage of the superheterodyne heretofore has been the large number of tubes and the complicated circuits required. The set illustrated here has only three tubes in the radio receiver proper and an extra tube for noise limiting or suppression.

The Circuit

The circuit utilizes a 6J8G hexode converter tube. Electron mixing takes place

through an extra grid connected inside of the tube to the oscillator triode section of the 6J8G. This triode has a high transconductance and oscillates vigorously even below five meters in the circuit shown. The oscillator circuit requires a tuning condenser which is not grounded or by-passed to ground for u.h.f. operation. This is easily accomplished by mounting this condenser on a small porcelain stand-off insulator and connecting the rotor to the dial and detector tuning condenser through insulated shaft couplings.

A high-C oscillator circuit gives good frequency stability and can be made to track easily with the low-C detector circuit for single dial tuning. Good oscillator stability is especially needed for c.w. reception of long distance 5-meter signals. These signals occasionally reach long distances when the ionized air layers are such as to reflect these very high frequencies back to earth.

Regeneration in the detector circuit was tried by tapping the cathode lead to a point near the grounded end of the detector tuned circuit. Variable screen

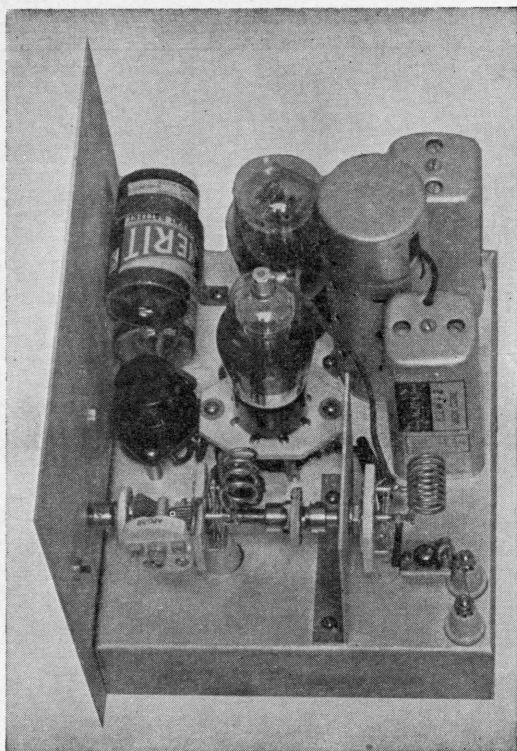

Figure 34. This simple, but effective, 5-meter superhet uses the same mixer, second detector and a.f. circuits as the "Super Gainer" described on page 181. An a.f. type noise silencer and an i.f. stage have been added for maximum performance on 56 Mc. The receiver is suitable for either phone or c.w. operation.

fully described in the preceding chapter on *Receiver Theory*.

The 1600-kc. i.f. provides about the proper degree of selectivity for reception of crystal-controlled or *stabilized* modulated-oscillator phone signals. Badly overmodulated or frequency-modulated signals are nearly unintelligible on this receiver. This should not be considered a drawback, as the number of such signals on 56 Mc. is rapidly dwindling, and the amateurs responsible for the few remaining broad signals should not be encouraged anyway. A remark that a signal is too "wobulated" to be copied on your receiver should provide an incentive to the owner of the signal to clean it up.

voltage was obtained through a potentiometer but little benefit seemed to result—possibly due to the oscillator circuit arrangement. The sensitivity was so much greater than expected with the circuit shown that additional regeneration was left out. And i.f. sensitivity control was needed due to overloading from any nearby 5-meter phone signals.

One stage of 1600-kc. i.f. was sufficient since the regenerative second detector adds to the gain and selectivity in the intermediate-frequency amplifier. A 6A6 acts as a regenerative second detector and one stage of audio amplification as in the super-gainer receiver described earlier in this chapter. For data on the a.f. and second detector circuits refer to the description of the all-wave super gainer. The front end also is similar except for mechanical arrangement. The 5-meter super gainer requires a special layout of the h.f. circuits in order to provide leads sufficiently short for efficient operation at 5 meters.

The theory and operation of the 6H6 full-wave a.f. type peak noise limiter is

Use as 56-Mc. Converter

By following the mixer circuit and substituting a receiver tuned to about 1600 kc. for the regular i.f.—second detector—audio channel, the front end of the gainer may be used as a 56-Mc. converter.

This arrangement provides a sharp-tuning 56-Mc. superhet combination and is recommended in all cases where economy or other factors do not permit the construction of a complete receiver on one chassis. Any broadcast or communications receiver tunable to the 1600-kc. region may supply the rear-end components of the combination.

The tuning will be too sharp for reception of modulated oscillator signals, particularly if the receiver used incorporates two 465-kc. i.f. stages, but it will definitely give better performance on crystal-controlled and *good* m.o.p.a. signals than any of the simpler superregenerative receivers. If the companion receiver is a broad-tuning set, such as a

t.r.f. broadcast receiver, signals from the better line-stabilized oscillators might be received.

Since the power requirements of the converter are very low, heater and B-supply connections may be made direct to the receiver. However, all connections between the converter and receiver must be kept as short as possible and should be shielded for best results.

Other Tube Combinations

Other tube combinations may be used in the five-meter receiver illustrated here. A 6K7 or 6K7G may be substituted for the 6D6 i.f. stage. A 6N7 metal tube usually has a little less hum level than a 6A6 or 6N7G in the second detector-audio circuit due to its better shielding. Any two triodes connected as diodes can

be substituted for the 6H6 noise limiter, but the 6H6 is so compact that it is highly recommended.

Construction

The receiver was built on a 14-gauge aluminum chassis 6"x8"x1 3/4" with 12-gauge front panel 7"x8 1/2". A vernier or slow motion dial is necessary and it must be insulated from the oscillator tuning condenser which it drives. The latter is mounted on a porcelain insulator and the detector tuning condenser is mounted on a 3"x3" 14-gauge aluminum bracket which acts as a shield between the oscillator and detector coils and condensers. The 6J8G tube is mounted up above the chassis on a porcelain socket in order to have short r.f. leads to the triode oscillator section. The 6D6 is shielded and

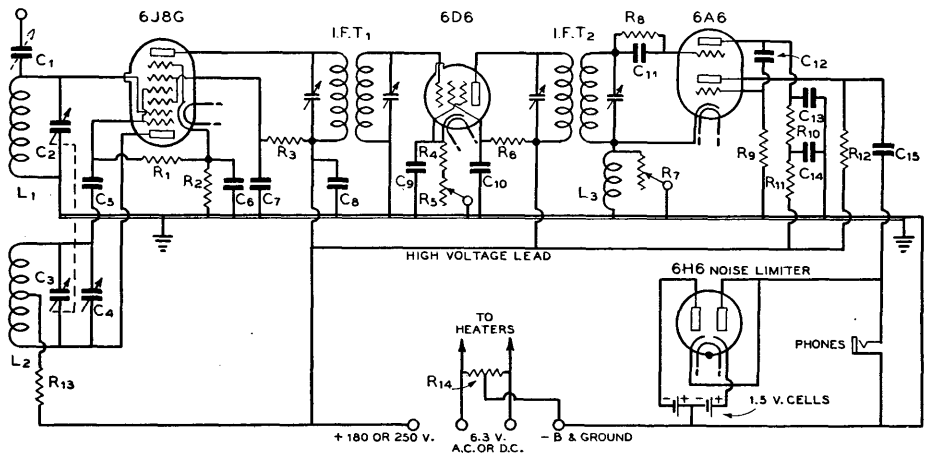

FIGURE 35. WIRING DIAGRAM FOR THE 5-METER SUPER GAINER.

- | | | | |
|---|---|--|--|
| C ₁ —3-30- μ fd. coupling condenser | C ₁₀ —.01- μ fd. mica by-pass | R ₃ —100,000 ohms, 1/2 watt | R ₁₁ —20,000 ohms, 1/2 watt |
| C ₂ —8- μ fd. tuning condenser. Re-vamped 15- μ fd. midget | C ₁₁ —.0001- μ fd. mica coupling | R ₄ —300 ohms, 1/2 watt | R ₁₂ —50,000 ohms, 1/2 watt |
| C ₃ —15- μ fd. midget tuning | C ₁₂ —.01- μ fd. 400-volt tubular | R ₅ —50,000-ohm rheostat | R ₁₃ —25,000 ohms, 1/2 watt |
| C ₄ —50- μ fd. midget air trimmer condenser | C ₁₃ —.002- μ fd. 400-volt tubular | R ₆ —100,000 ohms, 1/2 watt | R ₁₄ —50-ohm c.t. resistor |
| C ₅ —.0001- μ fd. mica coupling | C ₁₄ —0.5- μ fd. 400-volt tubular | R ₇ —1000-ohm rheostat | IFT _{1,2} —Midget 1600-kc. iron-core i.f. transformer |
| C ₆ , C ₇ —.005- μ fd. mica by-pass | C ₁₅ —.25- μ fd. 400-volt tubular | R ₈ —5 megohms, 1/2 watt | L ₁ , L ₂ —See text |
| C ₈ , C ₉ —0.1- μ fd. 400-volt tubular | R ₁ —50,000 ohms, 1/2 watt | R ₉ —500,000 ohms, 1/2 watt | L ₃ —40 turns, 1/2" dia., #28 d.s.c. jumble wound |
| | R ₂ —300 ohms, 1/2 watt | R ₁₀ —50,000 ohms | |

the 6A6 should also be shielded. The 6H6 was mounted above the chassis simply because it was added to the receiver at a later date. Ordinary iron-cored air or mica-tuned i.f. transformers are satisfactory.

Single-Dial Control

Two midget condensers were ganged for single-dial tuning control. An ordinary $\frac{5}{8}$ "-long brass spacer tube was carefully soldered to the shaft nubbin at the rear of the oscillator tuning condenser. This must be sweated on carefully with a soldering iron as too much heat will loosen the rotor plates. This hollow shaft extension can be easily soldered on over the nubbin by clamping the front end of the condenser shaft in a vise and holding the brass sleeve in line with a pair of pliers and a steady hand. The shaft extension provides a $\frac{1}{4}$ -in. diameter shaft for the rear insulated coupling and also spaces the tuning condensers farther apart. The rear or detector tuning condenser has one rotor and one stator plate removed, leaving only three plates. This leaves a tuning condenser with a maximum capacity of about 8 μfd .

The oscillator condenser has a maximum capacity of about 17 μfd . and by choosing the proper coils and oscillator trimmer condenser, the two circuits can be made to track 1600 kc. apart. A 50- μfd . midget condenser set at about three-quarters of its full capacity acts as a fixed tank condenser across the oscillator coil and provides a high-C oscillator circuit. The detector has no trimmer

condenser as it should have as low C-to-L ratio as possible for maximum signal sensitivity. The oscillator should always be tuned to 1600-kc. higher in frequency than the detector.

Coils

The coils are soldered to the tuning condenser terminals. The oscillator coil has 4 turns of no. 14 wire wound on $\frac{1}{2}$ -in. diameter and the turns spaced enough to make the coil about $\frac{3}{4}$ -in. long. The coil is center-tapped and the resistor is soldered directly to the coil with a lead about $\frac{3}{8}$ -in. long since this resistor must also serve as an r.f. choke in the oscillator circuit. The trimmer condenser is soldered to the tuning condenser with short, heavy leads. The detector coil is similar except that it has eight turns. The antenna is coupled to the detector through a mica trimmer condenser having a range of 3 to 30 μfd . It is set at a fairly low capacity—the two plates well-separated.

The total minimum capacity (with an average antenna) in the detector circuit is about 14 μfd . The revised tuning condenser has a range of about 5 μfd . so the detector circuit capacity ranges from approximately 14 up to 19 μfd ., enough to more than cover the amateur five-meter band. The oscillator minimum circuit capacity, trimmer, tube and other stray capacities should total 45 μfd . to track with the detector with the two coils shown. The oscillator tuning condenser, having five plates, has a capacity variation of about 14 μfd ., which gives a maximum circuit capacity of 59 μfd . and a minimum of 45 μfd .

ADVANCED 5-10 M. SUPERHETERODYNE

While the simple 56-Mc. superheterodyne receiver just described greatly outperforms the best superregenerative receivers and gives surprising results considering the cost, it is not the ultimate in 56-Mc. receivers. For the advanced experimenter who wants the last word in u.h.f. receivers and to whom cost is not an important item, the de luxe 5-10 meter superheterodyne of figure 36 is described.

The amplifier in this receiver uses

1,600-kc., air tuned i.f. transformers and the frequency of the i.f. amplifier can be made any value between 1,600 kc. and 5,000 kc. by changing the i.f. transformers and slightly altering the high-frequency oscillator coils. Choice of the intermediate frequency depends upon the service required. Higher intermediate frequency, such as 3,000 kc. or 5,000 kc., provides a more broadly tuned i.f. amplifier for 5-meter voice reception. The selectivity of the 1,600-kc. i.f. amplifier

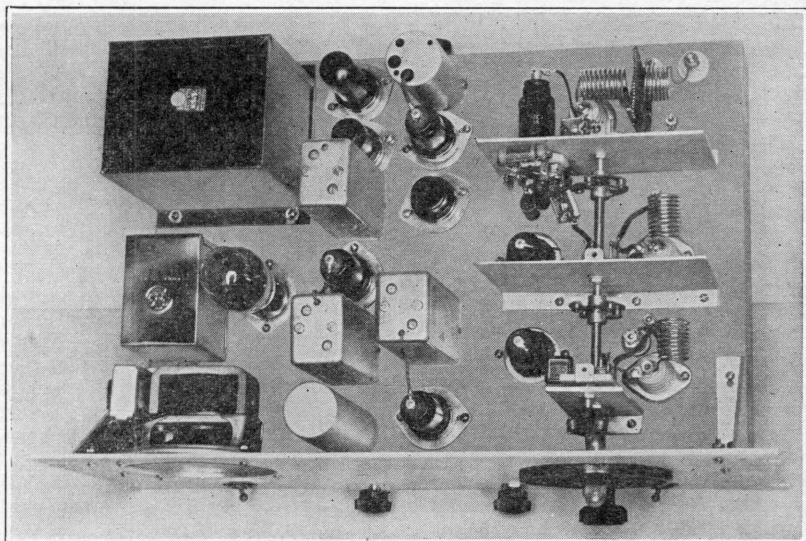

FIGURE 36. TOP VIEW OF THE DE LUXE 5-10 METER SUPERHETERODYNE SHOWING LAYOUT OF PARTS.

is rather great for reception of signals from an ordinary 5-meter transceiver, but is excellent for reception of m.o.p.a. or crystal-controlled 5-meter voice or c.w. signals. The high-frequency oscillator in this receiver could be crystal-controlled for police communication service where single-frequency reception is desired.

The receiver is tuned with a single dial. The r.f. stage is not of the regenerative type, thus simplifying the problem of ganging this tuned circuit with the first detector and oscillator circuits. The r.f. amplifier has appreciable gain on 5 meters, however, because of careful circuit design. Very short r.f. leads, low-C tuned circuits and a 6J7 sharp cutoff tube are used to accomplish this purpose. The 6J7 tube is operated at very low bias and high screen voltage and at somewhat more than normal plate current. Under these conditions, the tube has about the same plate current as a 6K7 variable μ tube operating under normal conditions, but produces about twice as much amplification.

The r.f. coupling circuit shown in the schematic diagram is very effective for high-frequency r.f. amplifiers. The variable plate coupling condenser allows exact alignment of the detector tuned circuit if the oscillator and r.f. trimmer condensers have previously been adjusted to the correct values. This method of cir-

cuit alignment can only be applied over a very narrow range, since the variation of coupling capacity changes the r.f. gain.

The r.f. amplifier plate can be connected to the positive B through a small r.f. choke of 75 turns of no. 34 d.s.c. wire, closewound on a $\frac{3}{8}$ -in. diameter bakelite rod. This choke coil is suitable for 5- and 10-meter operation, but will not have enough inductance for use on 20 meters. The receiver can be operated on 20 and 40 meters by winding additional coils on small plug-in forms. The 10,000-ohm resistor in series with the r.f. choke in the plate circuit allows operation on 20 or 40 meters (in spite of the too small r.f. choke) and the resistor does no harm when the set is used in the 5- or 10-meter bands.

Two stages of i.f. amplification give good selectivity and sufficient gain for satisfactory operation of the second detector and noise limiter circuit. Signal fading is minimized by applying a.v.c. voltage to the i.f. amplifier. A 10,000-ohm variable cathode-bias resistor serves as a control of sensitivity for c.w. reception. As the value of this bias resistor is increased, the a.v.c. effect becomes less, so that it is not necessary to cut out the a.v.c. for c.w. reception.

A beat frequency oscillator is coupled to the second detector diode plate

through a small capacitance consisting of a short length of hookup wire twisted twice around the plate lead of the diode. The b.f.o. consists of a standard electron-coupled oscillator tuned to produce a beat note with the 1,600-kc. signal for c.w. reception. The value of screen-grid resistor shown in the circuit diagram depends upon the type of tuned-grid coil and location of cathode tap. The b.f.o. coil is made by scramble-winding 150 turns of no. 30 d.s.c. wire on a $\frac{1}{2}$ -in. diameter dowel rod, with a winding length of one inch. The cathode tap is made one-quarter of the total number of turns up from the grounded end. The dowel rod is forced into a $\frac{1}{2}$ -in. diameter hole in the chassis, and this coil, grid leak and condenser are then shielded by covering them with an aluminum shield can. The 50- μ fd. tuning condenser is mounted on the rear of the chassis directly below the b.f.o. coil and the b.f.o. switch is mounted on the front panel for the sake of convenience.

Excessive b.f.o. injection into the second detector produces an objectionable amount of hiss and a consequent loss of sensitivity on weak signals. If the injection voltage is too low, the beat note on c.w. reception will be weak and strong signals can not be heterodyned. The amount of injection voltage can be varied by changing the coupling capacity between the two plate circuits and by changing the value of the screen-grid resistor.

The power supply and loud-speaker are built into the chassis. The presence of the loud-speaker produces an audio howl on signals having a strong carrier if the volume control is advanced too far. If high audio volume is desired, the loud-speaker should be mounted in a separate cabinet. The howling effect is an acoustic feedback from the loud-speaker to the tuning condenser plates and is not easily remedied.

The audio amplifier consists of a 6C5 triode, resistance-coupled into a 6F6 pentode. The 6C5 obtains its grid bias from the diode voltage; this bias voltage depends upon the signal strength and position of the arm on the volume control potentiometer. The bias is automatically increased when receiving strong signals or when the volume control is advanced for a high audio level. This arrangement is desirable in preference to fixed bias because of the noise-limiter circuit. The

difficulty lies in obtaining a quiet volume control, since there is a small flow of direct current through the resistor, and most types of volume controls tend eventually to become noisy under these conditions.

Construction of Receiver

The receiver is mounted on a cast aluminum chassis, 12"x17"x2 $\frac{1}{2}$ ". The front panel is 8 $\frac{3}{4}$ "x19", 10-gauge dural. There are three tuning condensers of the u.h.f. type, originally having a capacity of 35 μ fd. each and then reduced in capacity by removing all but two rotors and two stators in each condenser. These condensers are very efficient for u.h.f. operation because very short r.f. leads can be made; however, they are difficult to gang together for single-dial tuning. Extension shafts, two in number, each 1 $\frac{3}{4}$ -in. long, are cut from $\frac{1}{4}$ -in. round brass tubing having an *inside* diameter of $\frac{1}{8}$ inch. These are forced-fit over the $\frac{1}{8}$ -in. shafts on the tuning condensers and then soldered in place. This is accomplished by drilling a $\frac{1}{4}$ -in. hole in a block of wood which is clamped to the base plate of a drill press. The front shaft of the tuning condenser is then slipped into the $\frac{1}{4}$ -in. hole and the brass extension shaft is fastened into the chuck of the drill press. The chuck is then brought down until the brass tube slips over the $\frac{1}{8}$ -in. condenser shaft and the two are then sweated together with a hot soldering iron and solder. This alignment procedure results in a reasonably straight extension shaft which rotates on the shaft axis without wobbling.

Each tuning condenser is then mounted on an aluminum partition, with flexible couplings linking the shafts. The mounting holes for the condensers are made a little large so that the condensers can be lined up with the front section and tuning dial without binding when the dial is rotated. The aluminum panels which hold the condensers (three in number) are spaced 3 $\frac{1}{4}$ -inches apart; they also serve as r.f. shields between stages. The two larger aluminum shield brackets are 6 inches long and 4 inches high. The smaller bracket is used for the oscillator tuning condenser and padding condenser; this bracket is 2 inches wide and 4 inches high. Even when great care was exercised in lining up the condenser, the friction developed. This, plus the fric-

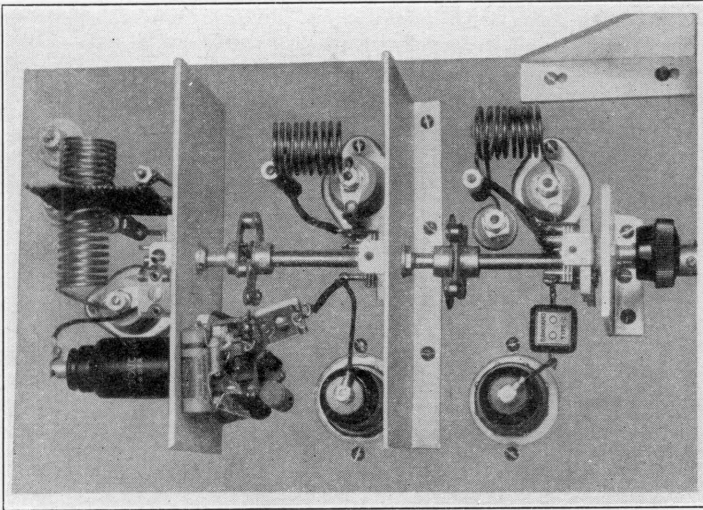

FIGURE 37. THE GANGED HIGH-FREQUENCY CIRCUITS.

tion of each condenser itself, required a vernier tuning dial with a powerful driving action. If care is taken to gang the condensers properly and if a good dial is chosen, it is easy to tune without backlash, even on 5-meter c.w. reception.

The oscillator components are mounted in the compartment closest to the front of the receiver in order to minimize backlash, which is inherent even in a solid $\frac{1}{4}$ -in. brass rod. The detector is mounted in the center compartment and the r.f. tube is mounted in a horizontal position in the third compartment at the rear of the chassis. The horizontal mounting makes it possible to run a very short plate lead, so that the efficiency even on 4 meters is relatively high. Plug-in coils, air supported, are used for the 5- and 10-meter bands. Brass stand-off supports are made by drilling a $\frac{1}{8}$ -in. hole in one end of a 5/16-in. round brass rod for receiving the banana-type plug on the coil. The other end of each brass standoff (1½ inches long) is drilled and tapped to take a 6/32 machine screw, so that the standoff can be supported to the chassis. Small porcelain stand-off insulators, 1½ inch high, support the grid end of each coil by means of a banana-type plug and jack.

The cathode of the oscillator feeds up through the chassis into a through-type insulator which has a plug in its end. The oscillator coil has three of the small banana-type plugs, whereas the detector

and r.f. coils have only two. The antenna coupling coil is mounted on stand-off insulators and the coupling remains fixed for all bands. This coil consists of 7 turns of no. 14 bare wire, $\frac{7}{8}$ -in. diameter, $\frac{3}{4}$ inch long. This coil can be center-tapped to ground for connection to a transposed two-wire feeder or connected to ground at one end for connection to a concentric line feeder or simple antenna and ground.

A *Faraday Screen* is mounted between the antenna coil and r.f. tuned circuit. This screen consists of parallel insulated wires, spaced one diameter of the wire, cemented to a flat sheet of celluloid. One end of all of these wires is soldered to a no. 12 bus wire which serves as a common support for the screen. This end is grounded. The remaining ends of all the wires are insulated from each other. The physical size of this screen is 2¼ in. wide and 2¾ in. high.

The Coils

The 5-meter detector and r.f. grid coils are both identical in size; each has 7 turns of no. 14 wire $\frac{5}{8}$ -in. diameter, and spaced to occupy a length of 1½ inches. The 5-meter oscillator coil consists of 6 turns of no. 14 wire, $\frac{5}{8}$ -in. diameter, space-wound to occupy a length of 1½ inches. The cathode tap is soldered to a point on the coil which is slightly more than one turn from the grounded end.

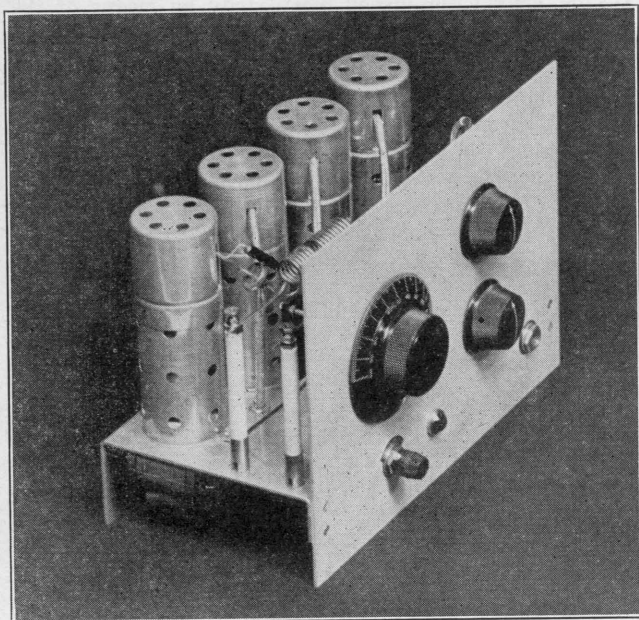

Figure 40. The 5-meter RC coupled superheterodyne shown here has very few parts and works quite well except that the tuning is rather broad.

detector oscillates weakly and never to the point of howling or superregeneration.

The coupling between the antenna coil and the first detector should be adjusted for best weak signal reception. Too much coupling to a resonant antenna will pre-

vent detector oscillation and proper superheterodyne action. In tuning the receiver dial, it will be found that all 5-meter signals will have two points on the dial, very close to each other, because the detector functions in a simple auto-dyne circuit.

A HIGH GAIN PRESELECTOR

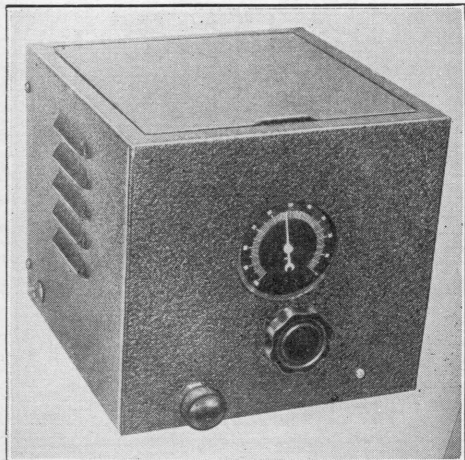

If a superheterodyne has less than two stages of preselection, its performance can be greatly improved by the addition of this high gain preselector. The improvement in image ratio and signal-to-noise ratio will be most noticeable on the higher frequency bands and will be especially noticeable if the receiver itself has no r.f. stage at all.

The preselector uses a type 1851 pentode. This tube has a low noise level and extremely high transconductance. In fact, it is necessary to tap the plate of the

Figure 41. This high-gain preselector uses an 1851 tube, tuned output circuit and moderate regeneration. It makes a worthwhile addition to any receiver having less than two r.f. stages.

tube down from the "hot" end of the tuned plate coil in order to avoid oscillation.

The tuned plate circuit is link-coupled to the input terminals of the receiver to which the preselector is to be attached. The coupling link is of the coaxial type, made of flexible shielded conductor. The use of a tuned output circuit and an efficient coupling system makes this preselector greatly superior in performance to the simpler, more common type of one-stage preselector in which the plate of the preselector tube is capacitively coupled to the antenna post of the receiver.

The preselector is moderately regenerative; in fact, the input circuit must be rather heavily coupled to an antenna or it will tend to oscillate.

The 1851 has a very low input resistance, especially on 10 meters. For this reason the grid is tapped down on the input coil, being connected approximately to the center of the coil. This reduces the grid loading to one-quarter without reducing the input voltage, due to the higher Q obtained with the tapped

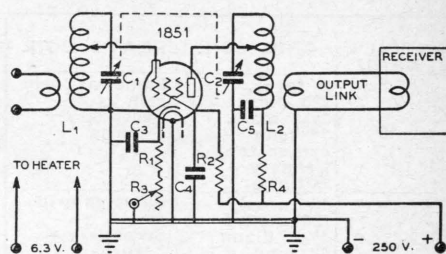

FIGURE 42. SCHEMATIC CIRCUIT OF THE 1851 PRESELECTOR.

- | | |
|--|--|
| C_1, C_2 —2-gang 50- μ fd. per section midget variable | R_2 —50,000 ohms, 1/2 watt |
| C_3 —0.1- μ fd. 400-volt tubular | R_3 —10,000-ohm potentiometer gain control |
| C_4, C_5 —.01- μ fd. 400 volt tubular | R_4 —5000 ohms, 1 watt |
| R_1 —200 ohms, 1 watt | Coils—See coil table |

arrangement. Not only are selectivity and image rejection greatly improved, but tracking is greatly simplified by tapping down on the grid coil.

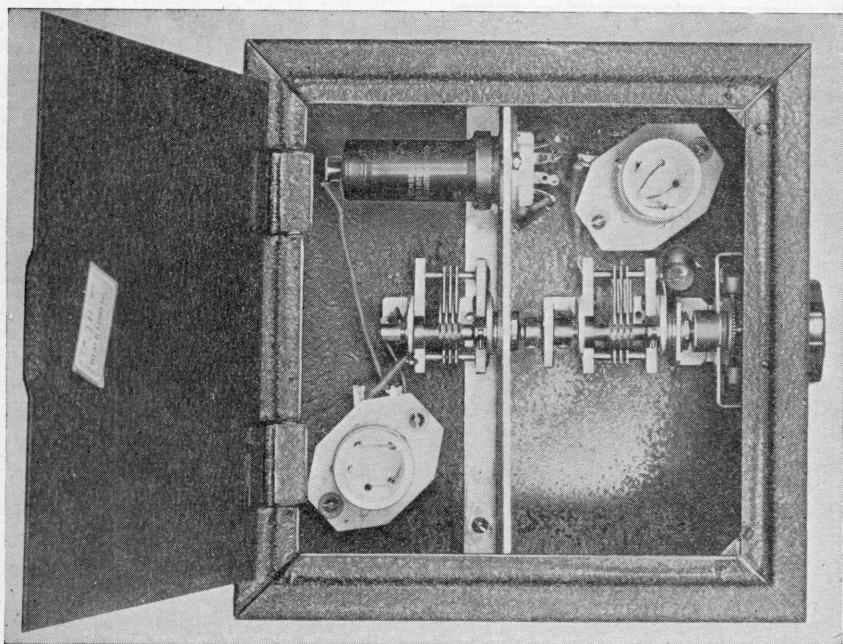

Figure 43. Looking down into the 1851 high-gain preselector. An aluminum partition shields the input from the output circuit, and serves as a support for the tube and rear tuning condenser.

1851 PRESELECTION COIL DATA

COIL BAND	GRID COIL	PLATE COIL
10	8 turns, #20 d.c.c. 1 1/8" diam. 1" long center tap Primary— 2 turns	Same as grid coil Secondary— 2 turns
20	15 turns #20 d.c.c. 1 1/8" diam. 1" long center tap Primary— 3 turns	Same as grid coil Secondary— 2 turns
40	24 turns #22 d.c.c. 1 1/2" diam. 1 1/2" long tap at 10 turns Primary— 5 turns	Same as grid coil tap at 12 turns Secondary— 3 turns
80	44 turns #24 d.c.c. 1 1/2" diam. 1 1/2" long tap at 15 turns Primary— 8 turns	Same as grid coil tap at 15 turns Secondary— 3 turns
160	80 turns #26 enam. 1 1/2" diam. closewound tap at approx. 20 turns Primary— 12 turns	Same as grid coil Secondary— 3 turns

Tapping the grid and plate leads down on their respective coils effectively reduces the minimum shunt capacities, thus allowing a greater tuning range with a given tuning condenser. With the 50- μ fd. tuning condensers illustrated, approximately a 2-1 range in frequency is possible with each set of coils. This gives practically continuous coverage of the short-wave spectrum with the coils listed in the coil table. The coils cover the following ranges: 1.7 to 3.5 Mc., 3 to 6 Mc., 6.5 to 11 Mc., 10 to 19 Mc. and 18 to 33 Mc. Thus, the preselector can be used effectively with communication re-

ceivers of the continuous coverage all-wave type.

If oscillation is troublesome even when tight antenna coupling is used, the plate coil can be tapped a little farther down towards the ground (B plus) end.

If desired, a 6J7 or 6K7 can be used in place of the 1851. If one of these tubes is used, both grid and plate should be connected directly to the "hot" ends of their respective coils, instead of to the center. The gain will not be quite as high as with an 1851 and the tuning range will be reduced slightly. The latter can be offset by using 75- μ fd. tuning condensers instead of 50- μ fd. condensers.

Tracking can be checked by rotating the rear tuning condenser separately while listening to a station and watching the R meter.

Construction

The unit is built in a 7"x7"x7" cabinet and chassis. A 6 1/4"x5 1/4" aluminum partition with a 1/2-in. lip to permit fastening to the chassis as illustrated in figure 43 shields the input from the output circuits. The rear tuning condenser is mounted on this partition and driven from the front condenser by means of an insulated coupling. While the tube is shown mounted horizontally, it could be just as well mounted vertically; the leads would be just about as short.

For maximum gain on the higher frequency range, tuning condensers, sockets and coil forms should have ceramic insulation.

Most receivers will stand a slight additional drain on the plate and filament supplies without overheating. For this reason, the preselector voltages may be robbed from the receiver with which it is to be used. If the receiver power supply already runs quite hot, indicating that it is being overloaded, a separate power supply is advisable.



CHAPTER 9
*Radio Receiver Tube
Characteristics*

Used by courtesy of RCA Manufacturing Company, Inc., Copyright proprietor.

TYPE	NAME	BASE	SOCKET CONNECTIONS	DIMENSIONS MAXIMUM OVERALL LENGTH X DIAMETER	CATHODE TYPE ■	RATING			
						FILAMENT OR HEATER		PLATE	SCREEN
						VOLTS	AMPERES	MAX. VOLTS	MAX. VOLTS
00-A	DETECTOR TRIODE	MEDIUM 4-PIN Bayonet	4D	4 $\frac{11}{16}$ " x 1 $\frac{13}{16}$ "	D-C FILAMENT	5.0	0.25	45	—
01-A	DETECTOR★ AMPLIFIER	MEDIUM 4-PIN Bayonet	4D	4 $\frac{11}{16}$ " x 1 $\frac{13}{16}$ "	D-C FILAMENT	5.0	0.25	135	—
0A4-G	GAS-TRIODE	SMALL SHELL OCTAL 6-PIN	G-4V	4 $\frac{1}{8}$ " x 1 $\frac{9}{16}$ "	COLD	—	—	—	—
1A4-P	SUPER-CONTROL R-F AMPLIFIER PENTODE	SMALL 4-PIN	4M	4 $\frac{17}{32}$ " x 1 $\frac{9}{16}$ "	D-C FILAMENT	2.0	0.06	180	67.5
1A6	PENTAGRID CONVERTER □	SMALL 6-PIN	6L	4 $\frac{17}{32}$ " x 1 $\frac{9}{16}$ "	D-C FILAMENT	2.0	0.06	180	67.5
1B4-P	R-F AMPLIFIER PENTODE	SMALL 4-PIN	4M	4 $\frac{17}{32}$ " x 1 $\frac{9}{16}$ "	D-C FILAMENT	2.0	0.06	180	67.5
1B5/25S	DUPLEX-DIODE TRIODE	SMALL 6-PIN	6M	4 $\frac{3}{16}$ " x 1 $\frac{9}{16}$ "	D-C FILAMENT	2.0	0.06	135	—
1C6	PENTAGRID CONVERTER □	SMALL 6-PIN	6L	4 $\frac{17}{32}$ " x 1 $\frac{9}{16}$ "	D-C FILAMENT	2.0	0.12	180	67.5
1C7-G	PENTAGRID CONVERTER □	SMALL SHELL OCTAL 8-PIN	G-7Z	4 $\frac{15}{32}$ " x 1 $\frac{9}{16}$ "	D-C FILAMENT	2.0	0.12	180	67.5
1D5-GP	SUPER-CONTROL R-F AMPLIFIER PENTODE	SMALL SHELL OCTAL 7-PIN	G-5Y	4 $\frac{15}{32}$ " x 1 $\frac{9}{16}$ "	D-C FILAMENT	2.0	0.06	180	67.5
1D7-G	PENTAGRID CONVERTER □	SMALL SHELL OCTAL 8-PIN	G-7Z	4 $\frac{15}{32}$ " x 1 $\frac{9}{16}$ "	D-C FILAMENT	2.0	0.06	180	67.5
1E5-GP	R-F AMPLIFIER PENTODE	SMALL SHELL OCTAL 7-PIN	G-5Y	4 $\frac{15}{32}$ " x 1 $\frac{9}{16}$ "	D-C FILAMENT	2.0	0.06	180	67.5
1E7-G	TWIN PENTODE POWER AMPLIFIER	SMALL SHELL OCTAL 8-PIN	G-8C	4 $\frac{1}{8}$ " x 1 $\frac{9}{16}$ "	D-C FILAMENT	2.0	0.24	135	135
1F4	POWER AMPLIFIER PENTODE	MEDIUM 5-PIN	5K	4 $\frac{11}{16}$ " x 1 $\frac{13}{16}$ "	D-C FILAMENT	2.0	0.12	135	135
1F5-G	POWER AMPLIFIER PENTODE	MEDIUM SHELL OCTAL 7-PIN	G-6X	4 $\frac{5}{8}$ " x 1 $\frac{13}{16}$ "	D-C FILAMENT	2.0	0.12	135	135
1F6	DUPLEX-DIODE PENTODE	SMALL 6-PIN	6W	4 $\frac{17}{32}$ " x 1 $\frac{9}{16}$ "	D-C FILAMENT	2.0	0.06	180	67.5
1F7-GV	DUPLEX-DIODE PENTODE	SMALL SHELL OCTAL 8-PIN	G-7AD	4 $\frac{15}{32}$ " x 1 $\frac{9}{16}$ "	D-C FILAMENT	2.0	0.06	180	67.5
1G5-G	POWER AMPLIFIER PENTODE	MEDIUM SHELL OCTAL 7-PIN	G-6X	4 $\frac{5}{8}$ " x 1 $\frac{13}{16}$ "	D-C FILAMENT	2.0	0.12	135	135
1H4-G	DETECTOR★ AMPLIFIER	SMALL SHELL OCTAL 7-PIN	G-5S	4 $\frac{1}{8}$ " x 1 $\frac{9}{16}$ "	D-C FILAMENT	2.0	0.06	180	—
1H6-G	DUPLEX-DIODE TRIODE	SMALL SHELL OCTAL 8-PIN	G-7AA	4 $\frac{1}{8}$ " x 1 $\frac{9}{16}$ "	D-C FILAMENT	2.0	0.06	135	—
1J6-G	TWIN-TRIODE AMPLIFIER	SMALL SHELL OCTAL 8-PIN	G-7AB	4 $\frac{1}{8}$ " x 1 $\frac{9}{16}$ "	D-C FILAMENT	2.0	0.24	135	—
1-V	HALF-WAVE RECTIFIER	SMALL 4-PIN	4G	4 $\frac{3}{16}$ " x 1 $\frac{9}{16}$ "	HEATER	6.3	0.3	—	—
2A3	POWER AMPLIFIER TRIODE	MEDIUM 4-PIN	4D	5 $\frac{3}{8}$ " x 2 $\frac{1}{16}$ "	FILAMENT	2.5	2.5	250 300	— —
2A5	POWER AMPLIFIER PENTODE	MEDIUM 6-PIN	6B	4 $\frac{11}{16}$ " x 1 $\frac{13}{16}$ "	HEATER	2.5	1.75	—	—
2A6	DUPLEX-DIODE HIGH- μ TRIODE	SMALL 6-PIN	6G	4 $\frac{13}{32}$ " x 1 $\frac{9}{16}$ "	HEATER	2.5	0.8	250	—
2A7	PENTAGRID CONVERTER □	SMALL 7-PIN	7C	4 $\frac{17}{32}$ " x 1 $\frac{9}{16}$ "	HEATER	2.5	0.8	250	100
2B7	DUPLEX-DIODE PENTODE	SMALL 7-PIN	7D	4 $\frac{17}{32}$ " x 1 $\frac{9}{16}$ "	HEATER	2.5	0.8	250	125
5T4	FULL-WAVE RECTIFIER	LARGE WAFER OCTAL 5-PIN	5T	4 $\frac{1}{2}$ " x 1 $\frac{23}{32}$ "	FILAMENT	5.0	2.0	—	—
5U4-G	FULL-WAVE RECTIFIER	MEDIUM SHELL OCTAL 6-PIN	G-5T‡	5 $\frac{5}{16}$ " x 2 $\frac{1}{16}$ "	FILAMENT	5.0	3.0	—	—
5V4-G	FULL-WAVE RECTIFIER	MEDIUM SHELL OCTAL 6-PIN	G-5L‡	4 $\frac{5}{8}$ " x 1 $\frac{13}{16}$ "	HEATER	5.0	2.0	—	—
5W4	FULL-WAVE RECTIFIER	SMALL WAFER OCTAL 5-PIN	5T	3 $\frac{1}{2}$ " x 1 $\frac{5}{16}$ "	FILAMENT	5.0	1.5	—	—
5X4-G	FULL-WAVE RECTIFIER	MEDIUM SHELL OCTAL 8-PIN	G-5Q	5 $\frac{5}{16}$ " x 2 $\frac{1}{16}$ "	FILAMENT	5.0	3.0	—	—

Receiver Tube Characteristics 215

USE <small>Values to right give operating conditions and characteristics for indicated typical use</small>	PLATE SUPPLY VOLTS	GRID BIAS ■ VOLTS	SCREEN SUPPLY VOLTS	SCREEN CURRENT MA.	PLATE CURRENT MA.	A-C PLATE RESISTANCE OHMS	TRANS-CONDUCTANCE (GRID-PLATE) μMHOS	AMPLIFICATION FACTOR	LOAD FOR STATED POWER OUTPUT OHMS	POWER OUTPUT WATTS	TYPE
GRID-LEAK DETECTOR	45	Grid Return to (-) Filament			1.5	30000	666	20	—	—	00-A
CLASS A AMPLIFIER	90 135	- 4.5 - 9.0	—	—	2.5 3.0	11000 10000	725 800	8.0 8.0	—	—	01-A
RELAY SERVICE	Peak Cathode Current, 100 max. ma. D-C Cathode Current, 25 max. ma. Starter-Anode Drop, 60 approx. volts. Anode Drop, 70 approx. volts.										0A4-G
CLASS A AMPLIFIER	For other characteristics, refer to Type 1D5-GP.										1A4-P
CONVERTER	For other characteristics, refer to Type 1D7-G.										1A6
CLASS A AMPLIFIER	For other characteristics, refer to Type 1E5-GP.										1B4-P
TRIODE UNIT AS AMPLIFIER	For other characteristics, refer to Type 1H6-G.										1B5/25S
CONVERTER	For other characteristics, refer to Type 1C7-G.										1C6
CONVERTER	135 180	{ - 3.0 min. }	67.5 67.5	2.0 2.0	1.3 1.5	550000 750000	Anode-Grid (#2): 180 max. volts, 3.3 ma. Oscillator-Grid (#1) Resistor ●, Conversion Conductance, 325 micromhos.			1C7-G	
CLASS A AMPLIFIER	90 180	{ - 3.0 min. }	67.5 67.5	0.9 0.8	2.2 2.3	600000 1000000	720 750	425 750	—	—	1D5-GP
CONVERTER	135 180	{ - 3.0 min. }	67.5 67.5	2.5 2.4	1.2 1.3	400000 500000	Anode-Grid (#2): 180 max. volts, 2.3 ma. Oscillator-Grid (#1) Resistor ●, Conversion Conductance, 300 micromhos.			1D7-G	
CLASS A AMPLIFIER	90 180	- 3.0 - 3.0	67.5 67.5	0.7 0.6	1.6 1.7	1000000 1500000	600 650	550 1000	—	—	1E5-GP
CLASS A AMPLIFIER	135	- 7.5	135	—	—	Power Output is for one tube at stated plate-to-plate load.			24000	0.65	1E7-G
CLASS A AMPLIFIER	For other characteristics, refer to Type 1F5-G.										1F4
CLASS A AMPLIFIER	90 135	- 3.0 - 4.5	90 135	1.3 2.6	4.0 8.0	240000 200000	1400 1700	340 340	20000 16000	0.12 0.34	1F5-G
PENTODE UNIT AS AMPLIFIER	For other characteristics, refer to Type 1F7-GV.										1F6
PENTODE UNIT AS R-F AMPLIFIER	180	- 1.5	67.5	0.6	2.0	1000000	650	650	—	—	1F7-GV
PENTODE UNIT AS A-F AMPLIFIER	135 ×	- 2.0	Screen Supply, 135 volts applied through 0.8-megohm resistor. Grid Resistor, ** 1.0 megohm. Voltage Gain, 46.								
CLASS A AMPLIFIER	90 135	- 6.0 -13.5	90 135	8.5 8.7	2.5 2.5	133000 160000	1500 1550	200 250	8500 9000	0.25 0.55	1G5-G
CLASS A AMPLIFIER	90 135 180	- 4.5 - 9.0 -13.5	—	—	—	2.5 3.0 3.1	11000 10300 10300	750 900 900	9.3 9.3 9.3	—	1H4-G
CLASS B AMPLIFIER	157.5	-15.0	—	—	1.0	—	—	—	8000	2.1	1H6-G
TRIODE UNIT AS CLASS A AMPLIFIER	135	- 3.0	—	—	0.8	35000	575	20	—	—	1H6-G
CLASS B AMPLIFIER	135 135	0 - 3.0	—	—	—	Power Output is for one tube at stated plate-to-plate load.			10000 10000	2.1 1.9	1J6-G
Maximum A-C Plate Voltage..... 350 Volts, RMS Maximum D-C Output Current..... 50 Milliamperes											1-V
CLASS A AMPLIFIER	250	- 45.0	—	—	60.0	800	5250	4.2	2500	3.5	2A3
PUSH-PULL CLASS AB ₁ AMPLIFIER	300 300	Self-bias, 780 ohms ● - 62 volts, fixed bias	—	—	80.0 ● 80.0 ●	—	—	—	5000 3000	10.0 † 15.0 †	
AMPLIFIER	For other ratings and characteristics, refer to Type 6F6.										2A5
TRIODE UNIT AS AMPLIFIER	For other characteristics, refer to Type 75.										2A6
CONVERTER	For other characteristics, refer to Type 6A7.										2A7
PENTODE UNIT AS AMPLIFIER	For other characteristics, refer to Type 6B8-G.										2B7
A-C Voltage per Plate (Volts RMS)..... 450 550 The 550-volt rating applies to filter circuits having an D-C Output Current (Maximum Ma.)..... 250 250 input choke of at least 10 henries.											5T4
Maximum A-C Voltage per Plate..... 500 Volts, RMS Maximum D-C Output Current..... 250 Milliamperes											5U4-G
Maximum A-C Voltage per Plate..... 400 Volts, RMS Maximum D-C Output Current..... 200 Milliamperes											5V4-G
Maximum A-C Voltage per Plate..... 350 Volts, RMS Maximum D-C Output Current..... 110 Milliamperes											5W4
For other ratings, refer to Type 5U4-G.											5X4-G

TYPE	NAME	BASE	SOCKET CONNECTIONS	DIMENSIONS MAXIMUM OVERALL LENGTH X DIAMETER	CATHODE TYPE ■	RATING			
						FILAMENT OR HEATER		PLATE	SCREEN
						VOLTS	AMPERES	MAX. VOLTS	MAX. VOLTS
5Y3-G	FULL-WAVE RECTIFIER	MEDIUM SHELL OCTAL 5-PIN	G-5T†	4 ⁵ / ₈ " x 1 ¹³ / ₁₆ "	FILAMENT	5.0	2.0	—	—
5Y4-G	FULL-WAVE RECTIFIER	MEDIUM SHELL OCTAL 8-PIN	G-5Q	4 ⁵ / ₈ " x 1 ¹³ / ₁₆ "	FILAMENT	5.0	2.0	—	—
5Z3	FULL-WAVE RECTIFIER	MEDIUM 4-PIN	4C	5 ³ / ₈ " x 2 ¹ / ₁₆ "	FILAMENT	5.0	3.0	—	—
5Z4	FULL-WAVE RECTIFIER	SMALL WAFER OCTAL 5-PIN	5L	3 ¹ / ₄ " x 1 ⁵ / ₁₆ "	HEATER	5.0	2.0	—	—
6A4/LA	POWER AMPLIFIER PENTODE	MEDIUM 5-PIN	5B	4 ¹¹ / ₁₆ " x 1 ¹³ / ₁₆ "	FILAMENT	6.3	0.3	180	180
6A6	TWIN-TRIODE AMPLIFIER	MEDIUM 7-PIN #	7B	4 ¹¹ / ₁₆ " x 1 ¹³ / ₁₆ "	HEATER	6.3	0.8	300	—
6A7	PENTAGRID CONVERTER Ⓞ	SMALL 7-PIN	7C	4 ¹⁷ / ₃₂ " x 1 ⁹ / ₁₆ "	HEATER	6.3	0.3	250	100
6A8	PENTAGRID CONVERTER Ⓞ	SMALL WAFER OCTAL 8-PIN	8A	3 ¹ / ₈ " x 1 ⁵ / ₁₆ "	HEATER	6.3	0.3	250	100
6A8-G	PENTAGRID CONVERTER Ⓞ	SMALL SHELL OCTAL 8-PIN	G-8A†	4 ¹⁵ / ₃₂ " x 1 ⁹ / ₁₆ "	HEATER	6.3	0.3	250	100
6AC5-G	HIGH-MU POWER AMPLIFIER TRIODE	SMALL SHELL OCTAL 6-PIN	G-6Q†	4 ¹ / ₈ " x 1 ⁹ / ₁₆ "	HEATER	6.3	0.4	250	—
6B7	DUPLEX-DIODE PENTODE	SMALL 7-PIN	7D	4 ¹⁷ / ₃₂ " x 1 ⁹ / ₁₆ "	HEATER	6.3	0.3	250	125
6B8	DUPLEX-DIODE PENTODE	SMALL WAFER OCTAL 8-PIN	8E	3 ¹ / ₈ " x 1 ⁵ / ₁₆ "	HEATER	6.3	0.3	250	125
6B8-G	DUPLEX-DIODE PENTODE	SMALL SHELL OCTAL 8-PIN	G-8E†	4 ¹⁵ / ₃₂ " x 1 ⁹ / ₁₆ "	HEATER	6.3	0.3	250	125
6C5	DETECTOR★ AMPLIFIER TRIODE	SMALL WAFER OCTAL 6-PIN	6Q	2 ⁵ / ₈ " x 1 ⁵ / ₁₆ "	HEATER	6.3	0.3	250	—
6C5-G	DETECTOR★ AMPLIFIER TRIODE	SMALL SHELL OCTAL 6-PIN	G-6Q††	4 ¹ / ₈ " x 1 ⁹ / ₁₆ "	HEATER	6.3	0.3	250	—
6C6	TRIPLE-GRID DETECTOR AMPLIFIER	SMALL 6-PIN	6F	4 ¹⁵ / ₁₆ " x 1 ⁹ / ₁₆ "	HEATER	6.3	0.3	250	100
6C8-G	TWIN TRIODE AMPLIFIER	SMALL SHELL OCTAL 8-PIN	G-8G	4 ¹⁵ / ₃₂ " x 1 ⁹ / ₁₆ "	HEATER	6.3	0.3	250	—
6D6	TRIPLE-GRID SUPER-CONTROL AMPLIFIER	SMALL 6-PIN	6F	4 ¹⁵ / ₁₆ " x 1 ⁹ / ₁₆ "	HEATER	6.3	0.3	250	100
6D8-G	PENTAGRID CONVERTER Ⓞ	SMALL SHELL OCTAL 8-PIN	G-8A†	4 ¹⁵ / ₃₂ " x 1 ⁹ / ₁₆ "	HEATER	6.3	0.15	250	100
6E5	ELECTRON-RAY TUBE	SMALL 6-PIN	6R	4 ³ / ₁₆ " x 1 ⁹ / ₁₆ "	HEATER	6.3	0.3	250†	—
6F5	HIGH-MU TRIODE	SMALL WAFER OCTAL 5-PIN	5M	3 ¹ / ₈ " x 1 ⁵ / ₁₆ "	HEATER	6.3	0.3	250	—
6F5-G	HIGH-MU TRIODE	SMALL SHELL OCTAL 5-PIN	G-5M††	4 ¹⁵ / ₃₂ " x 1 ⁹ / ₁₆ "	HEATER	6.3	0.3	250	—
6F6	POWER AMPLIFIER PENTODE	SMALL WAFER OCTAL 7-PIN	7S	3 ¹ / ₄ " x 1 ⁵ / ₁₆ "	HEATER	6.3	0.7	315	315
								315	—
								315	315
								375	250
								350	—
6F6-G	POWER AMPLIFIER PENTODE	MEDIUM SHELL OCTAL 7-PIN	G-7S†	4 ⁵ / ₈ " x 1 ¹³ / ₁₆ "	HEATER	6.3	0.7	—	—

Receiver Tube Characteristics 217

USE	PLATE SUPPLY VOLTS	GRID BIAS VOLTS	SCREEN SUPPLY VOLTS	SCREEN CURRENT MA.	PLATE CURRENT MA.	A-C PLATE RESISTANCE OHMS	TRANS-CONDUCTANCE (GRID-PLATE) μMHOS	AMPLIFICATION FACTOR	LOAD FOR STATED POWER OUTPUT OHMS	POWER OUTPUT WATTS	TYPE
Maximum A-C Voltage per Plate.....400 Volts, RMS Maximum D-C Output Current.....125 Milliamperes											
A-C Voltage per Plate (Volts RMS)..... 350 400 550 The 550-volt rating applies to filter circuits having an input choke of at least 20 henries.											
D-C Output Current (Maximum Ma.)..... 125 110 135											
For other ratings, refer to Type 5U4-G.											
Maximum A-C Voltage per Plate.....400 Volts, RMS Maximum D-C Output Current.....125 Milliamperes											
CLASS A AMPLIFIER	100 180	- 6.5 -12.0	100 180	1.6 3.9	9.0 22.0	83250 45500	1200 2200	100 100	11000 8000	0.31 1.40	6A4/LA
AMPLIFIER	For other characteristics, refer to Type 6N7.										
CONVERTER	100 250	{ - 3.0 } min.	50 100	2.5 2.2	1.3 3.5	600000 360000	Anode-Grid (#2): 250 μ max. volts, 4.0 ma. Oscillator-Grid (#1) Resistor α. Conversion Conductance, 520 micromhos.				6A7
CONVERTER	100 250	{ - 3.0 } min.	50 100	1.5 3.2	1.2 3.3	600000 360000	Anode-Grid (#2): 250 μ max. volts, 4.0 ma. Oscillator-Grid (#1) Resistor α. Conversion Conductance, 500 micromhos.				6A8
CONVERTER	For other characteristics, refer to Type 6A8.										
CLASS B AMPLIFIER	250	0	—	—	5.0 ♣	—	—	—	10000	8.0 †	6AC5-G
DYNAMIC COUPLED AMPLIFIER WITH TYPE 76 DRIVER	250	Bias for both 6AC5-G and 76 is developed in coupling circuit. Average Plate Current of Driver = 5.5 milliamperes. Average Plate Current of 6AC5-G = 32 milliamperes.							7000	3.7	
PENTODE UNIT AS AMPLIFIER	For other characteristics, refer to Type 6B8-G.										
PENTODE UNIT AS R-F AMPLIFIER	250	- 3.0	125	2.3	10.0	600000	1325	800	—	—	6B8
PENTODE UNIT AS A-F AMPLIFIER	90 ♣ 300 ♣	Self-bias, 3500 ohms. Screen Resistor = 1.1 meg. Self-bias, 1600 ohms. Screen Resistor = 1.2 meg.		Grid Resistor, ** 0.5 megohm.		Gain per stage = 55 Gain per stage = 79					
PENTODE UNIT AS R-F AMPLIFIER	100 250	- 3.0 - 3.0	100 125	1.7 2.3	5.8 9.0	300000 650000	950 1125	285 730			6B8-G
PENTODE UNIT AS A-F AMPLIFIER	90 ♣ 300 ♣	Self-bias, 3500 ohms. Screen Resistor = 1.1 meg. Self-bias, 1600 ohms. Screen Resistor = 1.2 meg.		Grid Resistor, ** 0.5 megohm.		Gain per stage = 55 Gain per stage = 79					
CLASS A AMPLIFIER	250	- 8.0	—	—	8.0	10000	2000	20			6C5
BIAS DETECTOR	90 ♣ 300 ♣	Self-bias, 6400 ohms. Self-bias, 5300 ohms.		Grid Resistor, ** 0.25 megohm		Gain per stage = 11 Gain per stage = 13					
CLASS A AMPLIFIER BIAS DETECTOR	250	-17.0 approx. Plate current to be adjusted to 0.2 milliamperes with no signal.									
AMPLIFIER BIAS DETECTOR	For other characteristics, refer to Type 6C5.										
EACH UNIT AS AMPLIFIER	250	- 4.5	—	—	3.2	22500	1600	36			6C8-G
AMPLIFIER MIXER	For other characteristics, refer to Type 6U7-G.										
CONVERTER	135 250	{ - 3.0 } min.	67.5 100	—	—	400000 320000	Anode-Grid (#2): 250 μ max. volts, Oscillator-Grid (#1) Resistor α. Conversion Conductance, 500 micromhos.				6D8-G
VISUAL INDICATOR	Plate & Target Supply = 100 volts. Triode Plate Resistor = 0.5 meg. Target Current = 1.0 ma. Grid Bias, -3.3 volts; Shadow Angle, 0°. Bias, 0 volts; Angle, 90°; Plate Current, 0.19 ma.										
	Plate & Target Supply = 250 volts. Triode Plate Resistor = 1.0 meg. Target Current = 4.0 ma. Grid Bias, -8.0 volts; Shadow Angle, 0°. Bias, 0 volts; Angle, 90°; Plate Current, 0.24 ma.										
CLASS A AMPLIFIER	250	- 2.0	—	—	0.9	66000	1500	100			6F5
	90 ♣ 300 ♣	Self-bias, 8800 ohms. Self-bias, 3200 ohms.		Grid Resistor, ** 0.5 megohm.		Gain per stage = 43 Gain per stage = 63					
CLASS A AMPLIFIER	For other characteristics, refer to Type 6F5.										
PENTODE CLASS A AMPLIFIER	250 315	- 16.5 -22.0	250 315	6.5 8.0	34.0 42.0	80000 75000	2500 2650	200 200	7000 7000	3.0 5.0	6F6
TRIODE CLASS A AMPLIFIER	250	- 20.0	—	—	31.0	2600	2600	6.8	4000	0.85	
PENTODE PUSH-PULL CLASS A AMPLIFIER	315 315	Self-bias -22	315 315	16.0 ♣ 16.0 ♣	84.0 ♣ 84.0 ♣	Self-Bias Resistor, 220 ohms ♣		10000 10000	13.0 † 13.0 †		
PENTODE PUSH-PULL CLASS AB ₂ AMPLIFIER	375 375	Self-bias -26.0	250 250	8.0 ♣ 5.0 ♣	54.0 ♣ 34.0 ♣	Self-Bias Resistor, 340 ohms ♣		10000 10000	19.0 † 19.0 †		
TRIODE PUSH-PULL CLASS AB ₂ AMPLIFIER	350 350	Self-bias -38.0	—	—	50.0 ♣ 45.0 ♣	Self-Bias Resistor, 730 ohms ♣		10000 6000	14.0 † 18.0 †		
AMPLIFIER	For other ratings and characteristics, refer to Type 6F6.										

TYPE	NAME	BASE	SOCKET CONNECTIONS	DIMENSIONS MAXIMUM OVERALL LENGTH x DIAMETER	CATHODE TYPE ■	RATING			
						FILAMENT OR HEATER		PLATE	SCREEN
						VOLTS	AMPERES	MAX. VOLTS	MAX. VOLTS
6F7	TRIODE- PENTODE	SMALL 7-PIN	7E	$4\frac{1}{2}'' \times 1\frac{9}{16}''$	HEATER	6.3	0.3	100	—
								250	100
								250	100
6F8-G	TWIN TRIODE AMPLIFIER	SMALL SHELL OCTAL 8-PIN	G-8G	$4\frac{5}{8}'' \times 1\frac{9}{16}''$	HEATER	6.3	0.6	250	—
6G5	ELECTRON-RAY TUBE	SMALL 6-PIN	6R	$4\frac{3}{16}'' \times 1\frac{9}{16}''$	HEATER	6.3	0.3	250	—
6G6-G	POWER AMPLIFIER PENTODE	SMALL SHELL OCTAL 7-PIN	G-7S†	$4\frac{1}{8}'' \times 1\frac{9}{16}''$	HEATER	6.3	0.15	180	180
6H6	TWIN DIODE	SMALL WAFER OCTAL 7-PIN	7Q	$1\frac{5}{8}'' \times 1\frac{5}{16}''$	HEATER	6.3	0.3	—	—
6H6-G	TWIN DIODE	SMALL SHELL OCTAL 7-PIN	G-7Q††	$4\frac{1}{8}'' \times 1\frac{9}{16}''$	HEATER	6.3	0.3	—	—
6J5	DETECTOR AMPLIFIER TRIODE	SMALL WAFER OCTAL 6-PIN	6Q	$2\frac{3}{8}'' \times 1\frac{5}{16}''$	HEATER	6.3	0.3	250	—
6J5-G	DETECTOR AMPLIFIER TRIODE	SMALL SHELL OCTAL 6-PIN	G-6Q‡	$4\frac{1}{8}'' \times 1\frac{9}{16}''$	HEATER	6.3	0.3	250	—
6J7	TRIPLE-GRID DETECTOR AMPLIFIER	SMALL WAFER OCTAL 7-PIN	7R	$3\frac{1}{8}'' \times 1\frac{5}{16}''$	HEATER	6.3	0.3	250	125
6J7-G	TRIPLE-GRID DETECTOR AMPLIFIER	SMALL SHELL OCTAL 7-PIN	G-7R††	$4\frac{1}{2}'' \times 1\frac{9}{16}''$	HEATER	6.3	0.3	250	125
6K5-G	HIGH-MU TRIODE	SMALL SHELL OCTAL 7-PIN	G-5U	$4\frac{3}{2}'' \times 1\frac{9}{16}''$	HEATER	6.3	0.3	250	—
6K6-G	POWER AMPLIFIER PENTODE	SMALL SHELL OCTAL 7-PIN	G-7S‡	$4\frac{1}{8}'' \times 1\frac{9}{16}''$	HEATER	6.3	0.4	250	250
6K7	TRIPLE-GRID SUPER-CONTROL AMPLIFIER	SMALL WAFER OCTAL 7-PIN	7R	$3\frac{1}{8}'' \times 1\frac{5}{16}''$	HEATER	6.3	0.3	250	125
6K7-G	TRIPLE-GRID SUPER-CONTROL AMPLIFIER	SMALL SHELL OCTAL 7-PIN	G-7R‡	$4\frac{1}{2}'' \times 1\frac{9}{16}''$	HEATER	6.3	0.3	250	125
6K8	TRIODE-HEXODE CONVERTER	SMALL WAFER OCTAL 6-PIN	8K	$3\frac{1}{8}'' \times 1\frac{5}{16}''$	HEATER	6.3	0.3	200	—
								250	100
6L5-G	DETECTOR AMPLIFIER TRIODE	SMALL SHELL OCTAL 6-PIN	G-6Q‡	$4\frac{1}{8}'' \times 1\frac{9}{16}''$	HEATER	6.3	0.15	250	—
6L6	BEAM POWER AMPLIFIER	SMALL WAFER OCTAL 7-PIN	7AC	$4\frac{5}{16}'' \times 1\frac{5}{8}''$	HEATER	6.3	0.9	375	250
								375	250
								400	300
								400	300
6L6-G	BEAM POWER AMPLIFIER	MEDIUM SHELL OCTAL 7-PIN	G-7AC‡	$5\frac{5}{16}'' \times 2\frac{1}{16}''$	HEATER	6.3	0.9	—	—
6L7	PENTAGRID MIXER A AMPLIFIER	SMALL WAFER OCTAL 7-PIN	7T	$3\frac{1}{8}'' \times 1\frac{5}{16}''$	HEATER	6.3	0.3	250	150
								250	100
6L7-G	PENTAGRID MIXER A AMPLIFIER	SMALL SHELL OCTAL 7-PIN	G-7T‡	$4\frac{1}{2}'' \times 1\frac{9}{16}''$	HEATER	6.3	0.3	—	—
6N5	ELECTRON-RAY TUBE	SMALL 6-PIN	6R	$4\frac{3}{16}'' \times 1\frac{9}{16}''$	HEATER	6.3	0.15	135	—
6N7	TWIN-TRIODE AMPLIFIER	SMALL WAFER OCTAL 8-PIN	8B	$3\frac{1}{4}'' \times 1\frac{5}{16}''$	HEATER	6.3	0.8	300	—
6N7-G	TWIN-TRIODE AMPLIFIER	MEDIUM SHELL OCTAL 8-PIN	G-8B‡	$4\frac{5}{8}'' \times 1\frac{1}{16}''$	HEATER	6.3	0.8	300	—

Receiver Tube Characteristics 219

USE <small>Values to right give operating conditions and characteristics for indicated typical use</small>	PLATE SUPPLY VOLTS	GRID BIAS VOLTS	SCREEN SUPPLY VOLTS	SCREEN CUR- RENT MA.	PLATE CUR- RENT MA.	A-C PLATE RESIS- TANCE OHMS	TRANS- CONDUCT- TANCE (GRID- PLATE) μMHOS	AMPLIFI- CATION FACTOR	LOAD FOR STATED POWER OUTPUT OHMS	POWER OUT- PUT WATTS	TYPE
TRIODE UNIT AS CLASS A AMPLIFIER	100	- 3.0	—	—	3.5	16000	500	8	—	—	6F7
PENTODE UNIT AS CLASS A AMPLIFIER	100 250	{ - 3.0 min. }	100 100	1.6 1.5	6.3 6.5	290000 850000	1050 1100	300 900	—	—	
PENTODE UNIT AS MIXER	250	-10.0	100	0.6	2.8	Oscillator Peak Volts = 7.0. Conversion Conductance = 300 micromhos.					
EACH UNIT AS AMPLIFIER	250	- 8.0	—	—	9.0	7700	2600	20	—	—	6F8-G
VISUAL INDICATOR	Plate & Target Supply = 100 volts. Triode Plate Resistor = 0.5 meg. Target Current = 1.0 ma. Grid Bias, -8 volts; Shadow Angle, 0°. Bias, 0 volts; Angle, 90°; Plate Current, 0.19 ma.										
	Plate & Target Supply = 250 volts. Triode Plate Resistor = 1.0 meg. Target Current = 4.0 ma. Grid Bias, -22 volts; Shadow Angle, 0°. Bias, 0 volts; Angle, 90°; Plate Current, 0.24 ma.										
CLASS A AMPLIFIER	135 180	- 6.0 - 9.0	135 180	2.0 2.5	11.5 15.0	170000 175000	2100 2300	360 400	12000 10000	0.6 1.1	6G6-G
TWIN-DIODE DETECTOR RECTIFIER	Maximum A-C Voltage per Plate.....100 Volts, RMS Maximum D-C Output Current..... 4 Milliamperes										
DETECTOR RECTIFIER	For other ratings, refer to Type 6H6.										
CLASS A AMPLIFIER	250	- 8	—	—	9.0	7700	2600	20	—	—	6J5
CLASS A AMPLIFIER	For other characteristics, refer to Type 6J5.										
CLASS A R-F AMPLIFIER	100 250	- 3.0 - 3.0	100 100	0.5 0.5	2.0 2.0	1000000 1.5 + \$	1185 1225	1185 1500+	—	—	6J7
CLASS A A-F AMPLIFIER	90 × 300 ×	Self-bias, 2600 ohms. Screen Resistor = 1.2 meg. Grid Resistor, ** { Gain per stage = 85 Self-bias, 1200 ohms. Screen Resistor = 1.2 meg. } 0.5 megohm. { Gain per stage = 140									
BIAS DETECTOR	250	- 4.3	100	Cathode current 0.43 ma.		—	Plate Resistor, 500000 ohms. Grid Resistor, ** 250000 ohms.				
AMPLIFIER BIAS DETECTOR	For other characteristics, refer to Type 6J7.										
CLASS A AMPLIFIER	100 250	- 1.5 - 3.0	—	—	0.35 1.1	78000 50000	900 1400	70 70	—	—	6K5-G
CLASS A AMPLIFIER	100 250	- 7.0 -18.0	100 250	1.6 5.5	9.0 32.0	103500 68000	1450 2200	150 150	12000 7600	0.33 3.40	6K6-G
CLASS A AMPLIFIER	90 250	{ - 3.0 min. }	90 125	1.3 2.6	5.4 10.5	315000 600000	1275 1650	400 990	—	—	6K7
MIXER IN SUPERHETERODYNE	250	-10.0	100	—	—	Oscillator Peak Volts = 7.0					
AMPLIFIER MIXER	For other characteristics, refer to Type 6K7.										
TRIODE UNIT AS OSCILLATOR	100	Triode-Grid Resistor [⊗]			3.5	Triode-Grid & Hexode-Grid Current, 0.15 ma.					
HEXODE UNIT AS MIXER	100 250	{ - 3.0 min. }	100 100	6.2 6.0	2.3 2.5	400000 600000	Conversion Conductance, 325 micromhos. Conversion Conductance, 350 micromhos.				
CLASS A AMPLIFIER	135 250	- 5.0 - 9.0	—	—	3.5 8.0	11300 9000	1500 1900	17 17	—	—	6L5-G
SINGLE-TUBE CLASS A ₁ AMPLIFIER	250	-14.0	250	5.0	72.0	—	—	—	2500	6.5	
PUSH-PULL CLASS A ₁ AMPLIFIER	250	-16.0	250	10.0	120.0	Self-Bias Resistor, 170 ohms.				2500	6.5
PUSH-PULL CLASS A ₁ AMPLIFIER	250	-16.0	250	10.0	120.0	Self-Bias Resistor, 125 ohms. ⊕				5000	14.5 †
PUSH-PULL CLASS AB ₁ AMPLIFIER	400	-25.0	300	6.0	102.0	Self-Bias Resistor, 200 ohms. ⊕				6600	34.0 †
PUSH-PULL CLASS AB ₂ AMPLIFIER	400	-20.0	300	4.0	88.0	—				6600	40.0 †
PUSH-PULL CLASS AB ₂ AMPLIFIER	400	-25.0	300	6.0	102.0	—				3800	60.0 †
AMPLIFIER	For other ratings and characteristics, refer to Type 6L6.										
MIXER IN SUPERHETERODYNE	250	- 3.0	100	7.1	2.4	Oscillator-Grid (#3) Bias, -10 volts. Grid #3 Peak Swing, 12 volts minimum. Conversion Conductance, 350 micromhos.					
CLASS A AMPLIFIER	250	{ - 3.0 min. }	100	6.5	5.3	800000	1100	880	—	—	6L7
MIXER AMPLIFIER	For other ratings and characteristics, refer to Type 6L7.										
VISUAL INDICATOR	Plate & Target Supply = 135 volts. Triode Plate Resistor = 0.25 meg. Target Current = 2.0 ma. Grid Bias, -12.0 volts; Shadow Angle, 0°. Bias, 0 volts; Angle, 90°; Plate Current, 0.5 ma.										
CLASS A AMPLIFIER (As Driver) ⊕	250 294	- 5.0 - 6.0	—	—	6.0 7.0	11300 11000	3100 3200	35 35	20000 or more	exceeds 0.4	6N7
CLASS B AMPLIFIER	250 300	0 0	—	—	Power Output is for one tube at stated plate-to-plate load.					8000 10000	
AMPLIFIER	For other characteristics, refer to Type 6N7.										

220 RADIO Handbook

TYPE	NAME	BASE	SOCKET CONNECTIONS	DIMENSIONS MAXIMUM OVERALL LENGTH X DIAMETER	CATHODE TYPE ■	RATING			
						FILAMENT OR HEATER		PLATE	SCREEN
						VOLTS	AMPERES	MAX. VOLTS	MAX. VOLTS
6Q7	DUPLEX-DIODE HIGH-MU TRIODE	SMALL WAFER OCTAL 7-PIN	7V	$3\frac{1}{8}'' \times 1\frac{5}{16}''$	HEATER	6.3	0.3	250	—
6Q7-G	DUPLEX-DIODE HIGH-MU TRIODE	SMALL SHELL OCTAL 7-PIN	G-7V‡	$4\frac{15}{32}'' \times 1\frac{9}{16}''$	HEATER	6.3	0.3	250	—
6R7	DUPLEX-DIODE TRIODE	SMALL WAFER OCTAL 7-PIN	7V	$3\frac{1}{8}'' \times 1\frac{5}{16}''$	HEATER	6.3	0.3	250	—
6R7-G	DUPLEX-DIODE TRIODE	SMALL SHELL OCTAL 7-PIN	G-7V‡	$4\frac{15}{32}'' \times 1\frac{9}{16}''$	HEATER	6.3	0.3	250	—
6S7	TRIPLE-GRID SUPER-CONTROL AMPLIFIER	SMALL WAFER OCTAL 7-PIN	7R	$3\frac{1}{8}'' \times 1\frac{5}{16}''$	HEATER	6.3	0.15	250	100
6S7-G	TRIPLE-GRID SUPER-CONTROL AMPLIFIER	SMALL SHELL OCTAL 7-PIN	G-7R‡	$4\frac{15}{32}'' \times 1\frac{9}{16}''$	HEATER	6.3	0.15	250	100
6T7-G	DUPLEX-DIODE HIGH-MU TRIODE	SMALL SHELL OCTAL 7-PIN	G-7V‡	$4\frac{15}{32}'' \times 1\frac{9}{16}''$	HEATER	6.3	0.15	250	—
6U5	ELECTRON-RAY TUBE	SMALL 6-PIN	6R	$4\frac{3}{16}'' \times 1\frac{3}{16}''$	HEATER	6.3	0.3	250	—
6U7-G	TRIPLE-GRID SUPER-CONTROL AMPLIFIER	SMALL SHELL OCTAL 7-PIN	G-7R‡	$4\frac{15}{32}'' \times 1\frac{9}{16}''$	HEATER	6.3	0.3	250	100
6V6	BEAM POWER AMPLIFIER	SMALL WAFER OCTAL 7-PIN	7AC	$3\frac{1}{4}'' \times 1\frac{5}{16}''$	HEATER	6.3	0.45	250 300	250 300
6V6-G	BEAM POWER AMPLIFIER	MEDIUM SHELL OCTAL 7-PIN	G-7AC‡	$4\frac{5}{8}'' \times 1\frac{13}{16}''$	HEATER	6.3	0.45	—	—
6X5	FULL-WAVE RECTIFIER	SMALL WAFER OCTAL 6-PIN	6S	$3\frac{1}{4}'' \times 1\frac{5}{16}''$	HEATER	6.3	0.6	—	—
6X5-G	FULL-WAVE RECTIFIER	SMALL SHELL OCTAL 6-PIN	G-6S‡	$4\frac{1}{8}'' \times 1\frac{9}{16}''$	HEATER	6.3	0.6	—	—
6Y6-G	BEAM POWER AMPLIFIER	MEDIUM SHELL OCTAL 7-PIN	G-7AC‡	$4\frac{5}{8}'' \times 1\frac{13}{16}''$	HEATER	6.3	1.25	135	135
6Z7-G	TWIN-TRIODE AMPLIFIER	SMALL SHELL OCTAL 8-PIN	G-8B‡	$4\frac{1}{8}'' \times 1\frac{9}{16}''$	HEATER	6.3	0.3	180	—
6ZY5-G	FULL-WAVE RECTIFIER	SMALL SHELL OCTAL 6-PIN	G-6S‡	$4\frac{1}{8}'' \times 1\frac{9}{16}''$	HEATER	6.3	0.3	—	—
10	POWER AMPLIFIER TRIODE	MEDIUM 4-PIN Bayonet	4D	$5\frac{5}{8}'' \times 2\frac{3}{16}''$	FILAMENT	7.5	1.25	425	—
11	DETECTOR AMPLIFIER TRIODE	WD 4-PIN	4F	$4\frac{1}{8}'' \times 1\frac{3}{16}''$	D-C FILAMENT	1.1	0.25	135	—
12	DETECTOR AMPLIFIER TRIODE	MEDIUM 4-PIN Bayonet	4D	$4\frac{11}{16}'' \times 1\frac{7}{16}''$	D-C FILAMENT	1.1	0.25	135	—
12Z3	HALF-WAVE RECTIFIER	SMALL 4-PIN	4G	$4\frac{3}{16}'' \times 1\frac{9}{16}''$	HEATER	12.6	0.3	—	—
15	R-F AMPLIFIER PENTODE	SMALL 5-PIN	5F	$4\frac{3}{32}'' \times 1\frac{9}{16}''$	HEATER	2.0	0.22	135	67.5
19	TWIN-TRIODE AMPLIFIER	SMALL 6-PIN	6C	$4\frac{3}{16}'' \times 1\frac{9}{16}''$	D-C FILAMENT	2.0	0.26	135	—
20	POWER AMPLIFIER TRIODE	TAPERED SMALL 4-PIN	4D	$4\frac{3}{8}'' \times 1\frac{3}{16}''$	D-C FILAMENT	3.3	0.132	135	—
22	R-F AMPLIFIER TETRODE	MEDIUM 4-PIN	4K	$5\frac{1}{32}'' \times 1\frac{13}{16}''$	D-C FILAMENT	3.3	0.132	135	67.5
24-A	R-F AMPLIFIER TETRODE	MEDIUM 6-PIN	5E	$5\frac{1}{32}'' \times 1\frac{13}{16}''$	HEATER	2.5	1.75	275	90
25A6	POWER AMPLIFIER PENTODE	SMALL WAFER OCTAL 7-PIN	7S	$3\frac{1}{4}'' \times 1\frac{5}{16}''$	HEATER	25.0	0.3	180	135
25A6-G	POWER AMPLIFIER PENTODE	MEDIUM SHELL OCTAL 7-PIN	G-7S‡	$4\frac{5}{8}'' \times 1\frac{13}{16}''$	HEATER	25.0	0.3	180	135
25A7-G	RECTIFIER- PENTODE	MEDIUM SHELL OCTAL 8-PIN	G-8F	$4\frac{3}{8}'' \times 1\frac{13}{16}''$	HEATER	25.0	0.3	100	100
25B6-G	POWER AMPLIFIER PENTODE	MEDIUM SHELL OCTAL 7-PIN	G-7S‡	$4\frac{5}{8}'' \times 1\frac{13}{16}''$	HEATER	25.0	0.3	95	95
25L6	BEAM POWER AMPLIFIER	SMALL WAFER OCTAL 7-PIN	7AC	$3\frac{1}{4}'' \times 1\frac{5}{16}''$	HEATER	25.0	0.3	110	110
25L6-G	BEAM POWER AMPLIFIER	MEDIUM SHELL OCTAL 7-PIN	G-7AC‡	$4\frac{5}{8}'' \times 1\frac{13}{16}''$	HEATER	25.0	0.3	110	110
25Z5	RECTIFIER- DOUBLER	SMALL 6-PIN	6E	$4\frac{3}{16}'' \times 1\frac{9}{16}''$	HEATER	25.0	0.3	—	—

Receiver Tube Characteristics 221

USE <small>Values to right give operating conditions and characteristics for indicated typical use</small>	PLATE SUPPLY VOLTS	GRID BIAS VOLTS	SCREEN SUPPLY VOLTS	SCREEN CURRENT MA.	PLATE CURRENT MA.	A-C PLATE RESISTANCE OHMS	TRANS-CONDUCTANCE (GRID-PLATE) μMHMS	AMPLIFICATION FACTOR	LOAD FOR STATED POWER OUTPUT OHMS	POWER OUTPUT WATTS	TYPE	
TRIODE UNIT AS CLASS A AMPLIFIER	100 250	- 1.5 - 3.0	—	—	0.35 1.1	87500 58000	800 1200	70 70	—	—	6Q7	
90x Self-bias, 7600 ohms. } Grid Resistor, ** 0.5 megohm. { Gain per stage = 32 300x Self-bias, 3000 ohms. } Gain per stage = 45												
TRIODE UNIT AS AMPLIFIER	For other characteristics, refer to Type 6Q7.										6Q7-G	
TRIODE UNIT AS CLASS A AMPLIFIER	90 300	Self-bias, 4400 ohms. Self-bias, 3800 ohms.	—	—	0.9 2.0	65000 62000	1000 1050	65 65	—	—	6R7	
[Grid Resistor, ** 0.25 megohm. { Gain per stage = 10 { Gain per stage = 10												
TRIODE UNIT AS AMPLIFIER	For other characteristics, refer to Type 6R7.										6R7-G	
CLASS A AMPLIFIER	135 250	{ - 3.0 } min. f	67.5 100	0.9 2.0	3.7 8.5	1000000	1250 1750	1750	—	—	6S7	
AMPLIFIER	For other characteristics, refer to Type 6S7.											
TRIODE UNIT AS CLASS A AMPLIFIER	135 250	- 1.5 - 3.0	—	—	0.9 1.2	65000 62000	1000 1050	65 65	—	—	6T7-G	
VISUAL INDICATOR	For other characteristics, refer to Type 6G5.											
CLASS A AMPLIFIER	100 250	{ - 3.0 } min. f	100 100	2.2 2.0	8.0 8.2	250000 800000	1500 1600	375 1280	—	—	6U7-G	
MIXER IN SUPERHETERODYNE	100 250	-10.0 -10.0	100 100	—	—	Oscillator Peak Volts = 7.0						
SINGLE-TUBE CLASS A1 AMPLIFIER	180 250	- 8.5 -12.5	180 250	3.0 4.5	29.0 45.0	—	—	—	5500 5000	2.00 4.25	6V6	
PUSH-PULL CLASS A1 AMPLIFIER	250 300	-15.0 -20.0	250 300	5.0 5.0	70.0 78.0	—	—	—	10000 8000	8.5 13.0		
AMPLIFIER	For other ratings and characteristics, refer to Type 6V6.										6V6-G	
Maximum A-C Voltage per Plate..... 350 Volts, RMS Maximum D-C Output Current..... 75 Milliamperes												
For other ratings, refer to Type 6X5.												
SINGLE-TUBE CLASS A1 AMPLIFIER	135	-13.5	135	3.0	58.0	—	—	—	2000	3.6	6Y6-G	
CLASS B AMPLIFIER	135 180	0 0	—	—	Power Output is for one tube at stated plate-to-plate load.					9000 12000	2.5 4.2	6Z7-G
Maximum A-C Voltage per Plate..... 350 Volts, RMS Maximum D-C Output Current..... 35 Milliamperes												
CLASS A AMPLIFIER	350 425	-32.0 -40.0	—	—	16.0 18.0	5150 5000	1550 1600	8.0 8.0	11000 10200	0.9 1.6	10	
CLASS A AMPLIFIER	90 135	- 4.5 -10.5	—	—	2.5 3.0	15500 15000	425 440	6.6 6.6	—	—	11 12	
Maximum A-C Plate Voltage..... 250 Volts, RMS Maximum D-C Output Current..... 60 Milliamperes												
CLASS A AMPLIFIER	67.5 135	- 1.5 - 1.5	67.5 67.5	0.3 0.3	1.85 1.85	630000 800000	710 750	450 600	—	—	15	
CLASS B AMPLIFIER	For other characteristics, refer to Type 1J6-G.										19	
CLASS A AMPLIFIER	90 135	-16.5 -22.5	—	—	3.0 6.5	8000 6300	415 525	3.3 3.3	9600 6500	0.045 0.110	20	
SCREEN-GRID R-F AMPLIFIER	135	- 1.5	45	0.6*	1.7	725000	375	270	—	—		
SCREEN-GRID R-F AMPLIFIER	135	- 1.5	67.5	1.3*	3.7	325000	500	160	—	—	22	
SCREEN-GRID R-F AMPLIFIER	180 250	- 3.0 - 3.0	90 90	1.7* 1.7*	4.0 4.0	400000 600000	1000 1050	400 630	—	—	24-A	
BIAS DETECTOR	250	{ -5.0 } approx. f	20 to 45	—	Plate current to be adjusted to 0.1 milliamperes with no signal.							
CLASS A AMPLIFIER	95 180	- 15.0 -20.0	95 135	4.0 7.5	20.0 38.0	45000 40000	2000 2500	90 100	4500 5000	0.9 2.75	25A6	
CLASS A AMPLIFIER	For other characteristics, refer to Type 25A6.											
PENTODE UNIT AS CLASS A AMPLIFIER	100	- 15.0	100	4.0	20.5	50000	1800	90	4500	0.77	25A7-G	
HALF-WAVE RECTIFIER	Maximum A-C Voltage per Plate..... 125 Volts, RMS Maximum D-C Output Current..... 75 Milliamperes											
CLASS A AMPLIFIER	95	- 15.0	95	4.0	45.0	—	4000	—	2000	1.75	25B6-G	
SINGLE-TUBE CLASS A1 AMPLIFIER	110 110	- 7.5 - 7.5	110 110	4.0 4.0	49.0 49.0	10000 10000	8200 8200	82 82	1500 2000	2.1 2.2	25L6	
SINGLE-TUBE CLASS A1 AMPLIFIER	For other characteristics, refer to Type 25L6.											
VOLTAGE DOUBLER	Maximum A-C Voltage per Plate..... 125 Volts, RMS Maximum D-C Output Current..... 100 Milliamperes										25Z5	
HALF-WAVE RECTIFIER	Maximum A-C Voltage per Plate..... 250 Volts, RMS Maximum D-C Output Current per Plate..... 85 Milliamperes											

222 RADIO Handbook

TYPE	NAME	BASE	SOCKET CONNECTIONS	DIMENSIONS MAXIMUM OVERALL LENGTH X DIAMETER	CATHODE TYPE ■	RATING			
						FILAMENT OR HEATER		PLATE	SCREEN
						VOLTS	AMPERES	MAX. VOLTS	MAX. VOLTS
2526	RECTIFIER- DOUBLER	SMALL WAFER OCTAL 7-PIN	7Q	$3\frac{1}{4}'' \times 1\frac{5}{16}''$	HEATER	25.0	0.3	—	—
2526-G	RECTIFIER- DOUBLER	SMALL SHELL OCTAL 7-PIN	G-7Q†	$4\frac{1}{8}'' \times 1\frac{9}{16}''$	HEATER	25.0	0.3	—	—
26	AMPLIFIER TRIODE	MEDIUM 4-PIN	4D	$4\frac{11}{16}'' \times 1\frac{13}{16}''$	FILAMENT	1.5	1.05	180	—
27	DETECTOR★ AMPLIFIER TRIODE	MEDIUM 5-PIN	5A	$4\frac{3}{16}'' \times 1\frac{9}{16}''$	HEATER	2.5	1.75	275	—
30	DETECTOR★ AMPLIFIER TRIODE	SMALL 4-PIN	4D	$4\frac{3}{16}'' \times 1\frac{9}{16}''$	D-C FILAMENT	2.0	0.06	180	—
31	POWER AMPLIFIER TRIODE	SMALL 4-PIN	4D	$4\frac{3}{16}'' \times 1\frac{9}{16}''$	D-C FILAMENT	2.0	0.13	180	—
32	R-F AMPLIFIER TETRODE	MEDIUM 4-PIN	4K	$5\frac{1}{32}'' \times 1\frac{13}{16}''$	D-C FILAMENT	2.0	0.06	180	67.5
33	POWER AMPLIFIER PENTODE	MEDIUM 5-PIN	5K	$4\frac{11}{16}'' \times 1\frac{13}{16}''$	D-C FILAMENT	2.0	0.26	180	180
34	SUPER-CONTROL R-F AMPLIFIER PENTODE	MEDIUM 4-PIN	4M	$5\frac{1}{32}'' \times 1\frac{13}{16}''$	D-C FILAMENT	2.0	0.06	180	67.5
35	SUPER-CONTROL R-F AMPLIFIER TETRODE	MEDIUM 5-PIN	5E	$5\frac{1}{32}'' \times 1\frac{13}{16}''$	HEATER	2.5	1.75	275	90
36	R-F AMPLIFIER TETRODE	SMALL 5-PIN	5E	$4\frac{17}{32}'' \times 1\frac{9}{16}''$	HEATER	6.3	0.3	250	90
37	DETECTOR★ AMPLIFIER TRIODE	SMALL 5-PIN	5A	$4\frac{3}{16}'' \times 1\frac{9}{16}''$	HEATER	6.3	0.3	250	—
38	POWER AMPLIFIER PENTODE	SMALL 5-PIN	5F	$4\frac{17}{32}'' \times 1\frac{9}{16}''$	HEATER	6.3	0.3	250	250
39/44	SUPER-CONTROL R-F AMPLIFIER PENTODE	SMALL 5-PIN	5F	$4\frac{17}{32}'' \times 1\frac{9}{16}''$	HEATER	6.3	0.3	250	90
40	VOLTAGE AMPLIFIER TRIODE	MEDIUM 4-PIN Bayonet	4D	$4\frac{11}{16}'' \times 1\frac{13}{16}''$	D-C FILAMENT	5.0	0.25	180	—
41	POWER AMPLIFIER PENTODE	SMALL 6-PIN	6B	$4\frac{3}{16}'' \times 1\frac{9}{16}''$	HEATER	6.3	0.4	250	250
42	POWER AMPLIFIER PENTODE	MEDIUM 6-PIN	6B	$4\frac{11}{16}'' \times 1\frac{13}{16}''$	HEATER	6.3	0.7	—	—
43	POWER AMPLIFIER PENTODE	MEDIUM 6-PIN	6B	$4\frac{11}{16}'' \times 1\frac{13}{16}''$	HEATER	25.0	0.3	180	135
45	POWER AMPLIFIER TRIODE	MEDIUM 4-PIN	4D	$4\frac{11}{16}'' \times 1\frac{13}{16}''$	FILAMENT	2.5	1.5	275	—
46	DUAL-GRID POWER AMPLIFIER	MEDIUM 5-PIN	5C	$5\frac{3}{8}'' \times 2\frac{1}{16}''$	FILAMENT	2.5	1.75	250 400	— —
47	POWER AMPLIFIER PENTODE	MEDIUM 5-PIN	5B	$5\frac{3}{8}'' \times 2\frac{1}{16}''$	FILAMENT	2.5	1.75	250	250
48	POWER AMPLIFIER TETRODE	MEDIUM 6-PIN	6A	$5\frac{3}{8}'' \times 2\frac{1}{16}''$	D-C HEATER	30.0	0.4	125	100
49	DUAL-GRID POWER AMPLIFIER	MEDIUM 5-PIN	5C	$4\frac{11}{16}'' \times 1\frac{13}{16}''$	D-C FILAMENT	2.0	0.12	135 180	— —
50	POWER AMPLIFIER TRIODE	MEDIUM 4-PIN Bayonet	4D	$6\frac{1}{4}'' \times 2\frac{1}{16}''$	FILAMENT	7.5	1.25	450	—
53	TWIN-TRIODE AMPLIFIER	MEDIUM 7-PIN■	7B	$4\frac{11}{16}'' \times 1\frac{13}{16}''$	HEATER	2.5	2.0	300	—
55	DUPLEX-DIODE TRIODE	SMALL 6-PIN	6G	$4\frac{7}{16}'' \times 1\frac{9}{16}''$	HEATER	2.5	1.0	250	—
56	SUPER-TRIODE AMPLIFIER DETECTOR★	SMALL 5-PIN	5A	$4\frac{3}{16}'' \times 1\frac{9}{16}''$	HEATER	2.5	1.0	250	—
57	TRIPLE-GRID DETECTOR AMPLIFIER	SMALL 6-PIN	6F	$4\frac{15}{16}'' \times 1\frac{9}{16}''$	HEATER	2.5	1.0	250	100

Receiver Tube Characteristics 223

USE <small>Values to right give operating conditions and characteristics for indicated typical use</small>	PLATE SUPPLY VOLTS	GRID BIAS VOLTS	SCREEN SUPPLY VOLTS	SCREEN CURR-RENT MA.	PLATE CURR-RENT MA.	A-C PLATE RESIS-TANCE OHMS	TRANS-CONDUCTANCE (GRID-PLATE) μMHMS	AMPLIFI-CATION FACTOR	LOAD FOR STATED POWER OUTPUT OHMS	POWER OUT-PUT WATTS	TYPE
VOLTAGE DOUBLER	Maximum A-C Voltage per Plate.....125 Volts, RMS										25Z6
HALF-WAVE RECTIFIER	Maximum D-C Output Current..... 85 Milliamperes										
RECTIFIER-DOUBLER	Maximum A-C Voltage per Plate †.....250 Volts, RMS										25Z6-G
CLASS A AMPLIFIER	Maximum D-C Output Current per Plate..... 85 Milliamperes										
CLASS A AMPLIFIER	90	-7.0	—	—	2.9	8900	935	8.3	—	—	26
	180	-14.5	—	—	6.2	7300	1150	8.3	—	—	
CLASS A AMPLIFIER	135	-9.0	—	—	4.5	9000	1000	9.0	—	—	27
	250	-21.0	—	—	5.2	9250	975	9.0	—	—	
BIAS DETECTOR	250	{-30.0} (approx.)	—	—	Plate current to be adjusted to 0.2 milliampere with no signal.						30
AMPLIFIER	For other ratings, refer to Type 1H4-G.										
CLASS A AMPLIFIER	135	-22.5	—	—	8.0	4100	925	3.8	7000	0.185	31
	180	-30.0	—	—	12.3	3600	1050	3.8	5700	0.375	
SCREEN-GRID R-F AMPLIFIER	135	-3.0	67.5	0.4*	1.7	950000	640	610	—	—	32
	180	-3.0	67.5	0.4*	1.7	1200000	650	780	—	—	
BIAS DETECTOR	180	{-6.0} (approx.)	67.5	—	Plate current to be adjusted to 0.2 milliampere with no signal.						33
CLASS A AMPLIFIER	180	-18.0	180	5.0	22.0	55000	1700	90	6000	1.4	
SCREEN-GRID R-F AMPLIFIER	135	{-3.0} min.	67.5	1.0	2.8	600000	600	360	—	—	34
	180	{-3.0} min.	67.5	1.0	2.8	1000000	620	620	—	—	
SCREEN-GRID R-F AMPLIFIER	180	{-3.0} min.	90	2.5*	6.3	300000	1020	305	—	—	35
	250	{-3.0} min.	90	2.5*	6.5	400000	1050	420	—	—	
SCREEN-GRID R-F AMPLIFIER	100	-1.5	55	—	1.8	550000	850	470	—	—	36
	250	-3.0	90	1.7*	3.2	550000	1080	595	—	—	
BIAS DETECTOR	100	-5.0	55	—	Grid-bias values are approximate. Plate current to be adjusted to 0.1 milliampere with no signal.						37
	250	-8.0	90	—	2.5	11500	800	9.2	—	—	
CLASS A AMPLIFIER	90	-6.0	—	—	7.5	8400	1100	9.2	—	—	38
	250	-18.0	—	—	2.5	140000	875	120	15000	0.27	
BIAS DETECTOR	90	-10.0	—	—	Grid-bias values are approximate. Plate current to be adjusted to 0.2 milliampere with no signal.						39/44
	250	-28.0	—	—	22.0	100000	1200	120	10000	2.50	
CLASS A AMPLIFIER	100	-9.0	100	1.2	7.0	140000	875	120	15000	0.27	38
	250	-25.0	250	3.8	22.0	100000	1200	120	10000	2.50	
CLASS A AMPLIFIER	90	{-3.0} min.	90	1.6	5.6	375000	960	360	—	—	39/44
	250	{-3.0} min.	90	1.4	5.8	1000000	1050	1050	—	—	
CLASS A AMPLIFIER	135	-1.5	—	—	0.2	150000	200	30	—	—	40
	180	-3.0	—	—	0.2	150000	200	30	—	—	
CLASS A AMPLIFIER	For other characteristics, refer to Type 6K6-G.										41
AMPLIFIER	For other ratings and characteristics, refer to Type 6F6.										42
CLASS A AMPLIFIER	For other characteristics, refer to Type 25A6.										43
CLASS A AMPLIFIER	180	-31.5	—	—	31.0	1650	2125	3.5	2700	0.82	45
	275	-56.0	—	—	36.0	1700	2050	3.5	4600	2.00	
PUSH-PULL CLASS AB ₂ AMPLIFIER	275	Self-bias, 775 ohms	—	—	72.0	—	—	—	5060	12.0†	46
	275	-68.0 volts, fixed bias	—	—	28.0	—	—	—	3200	18.0†	
CLASS A AMPLIFIER □	250	-33.0	—	—	22.0	2380	2350	5.6	6400	1.25	46
CLASS B AMPLIFIER †	300	0	—	—	8.0	—	—	—	5200	16.0†	
	400	0	—	—	12.0	—	—	—	5800	20.0†	
CLASS A AMPLIFIER	250	-16.5	250	6.0	31.0	60000	2500	150	7000	2.7	47
TETRODE CLASS A AMPLIFIER	96	-19.0	96	9.0	52.0	—	3800	—	1500	2.0	48
	125	-20.0	100	9.5	56.0	—	3900	—	1500	2.5	
TETRODE PUSH-PULL CLASS A AMPLIFIER	125	-20.0	100	—	100.0	—	—	—	3000	5.0†	49
CLASS A AMPLIFIER □	135	-20.0	—	—	6.0	4175	1125	4.7	11000	0.17	
CLASS B AMPLIFIER †	180	0	—	—	4.0	—	—	—	12000	3.5†	
CLASS A AMPLIFIER	300	-54.0	—	—	35.0	2000	1900	3.8	4600	1.6	50
	400	-70.0	—	—	55.0	1800	2100	3.8	3670	3.4	
	450	-84.0	—	—	55.0	1800	2100	3.8	4350	4.6	
AMPLIFIER	For other characteristics, refer to Type 6N7.										53
TRIODE UNIT AS AMPLIFIER	For other characteristics, refer to Type 85.										55
AMPLIFIER DETECTOR	For other characteristics, refer to Type 76.										56
AMPLIFIER DETECTOR	For other characteristics, refer to Type 6J7.										57

TYPE	NAME	BASE	SOCKET CONNECTIONS	DIMENSIONS MAXIMUM OVERALL LENGTH X DIAMETER	CATHODE TYPE ^m	RATING			
						FILAMENT OR HEATER		PLATE	SCREEN
						VOLTS	AMPERES	MAX. VOLTS	MAX. VOLTS
58	TRIPLE-GRID SUPER-CONTROL AMPLIFIER	SMALL 6-PIN	6F	4 $\frac{1}{16}$ " x 1 $\frac{9}{16}$ "	HEATER	2.5	1.0	250	100
59	TRIPLE-GRID POWER AMPLIFIER	MEDIUM 7-PIN ⁿ	7A	5 $\frac{3}{8}$ " x 2 $\frac{1}{16}$ "	HEATER	2.5	2.0	250	—
								250	250
								400	—
71-A	POWER AMPLIFIER TRIODE	MEDIUM 4-PIN Bayonet	4D	4 $\frac{1}{16}$ " x 1 $\frac{13}{16}$ "	FILAMENT	5.0	0.25	180	—
75	DUPLEX-DIODE HIGH-MU TRIODE	SMALL 6-PIN	6G	4 $\frac{1}{32}$ " x 1 $\frac{9}{16}$ "	HEATER	6.3	0.3	250	—
76	SUPER-TRIODE AMPLIFIER DETECTOR [★]	SMALL 5-PIN	5A	4 $\frac{3}{16}$ " x 1 $\frac{9}{16}$ "	HEATER	6.3	0.3	250	—
77	TRIPLE-GRID DETECTOR AMPLIFIER	SMALL 6-PIN	6F	4 $\frac{1}{32}$ " x 1 $\frac{9}{16}$ "	HEATER	6.3	0.3	250	100
78	TRIPLE-GRID SUPER-CONTROL AMPLIFIER	SMALL 6-PIN	6F	4 $\frac{1}{32}$ " x 1 $\frac{9}{16}$ "	HEATER	6.3	0.3	250	125
79	TWIN-TRIODE AMPLIFIER	SMALL 6-PIN	6H	4 $\frac{1}{32}$ " x 1 $\frac{9}{16}$ "	HEATER	6.3	0.6	250	—
80	FULL-WAVE RECTIFIER	MEDIUM 4-PIN	4C	4 $\frac{1}{16}$ " x 1 $\frac{13}{16}$ "	FILAMENT	5.0	2.0	—	—
81	HALF-WAVE RECTIFIER	MEDIUM 4-PIN Bayonet	4B	6 $\frac{1}{4}$ " x 2 $\frac{7}{16}$ "	FILAMENT	7.5	1.25	—	—
82	FULL-WAVE [►] RECTIFIER	MEDIUM 4-PIN	4C	4 $\frac{1}{16}$ " x 1 $\frac{13}{16}$ "	FILAMENT	2.5	3.0	—	—
83	FULL-WAVE [►] RECTIFIER	MEDIUM 4-PIN	4C	5 $\frac{3}{8}$ " x 2 $\frac{1}{16}$ "	FILAMENT	5.0	3.0	—	—
83-V	FULL-WAVE RECTIFIER	MEDIUM 4-PIN	4L	4 $\frac{1}{16}$ " x 1 $\frac{13}{16}$ "	HEATER	5.0	2.0	—	—
84/6Z4	FULL-WAVE RECTIFIER	SMALL 5-PIN	5D	4 $\frac{3}{16}$ " x 1 $\frac{9}{16}$ "	HEATER	6.3	0.5	—	—
85	DUPLEX-DIODE TRIODE	SMALL 6-PIN	6G	4 $\frac{1}{32}$ " x 1 $\frac{9}{16}$ "	HEATER	6.3	0.3	250	—
89	TRIPLE-GRID POWER AMPLIFIER	SMALL 6-PIN	6F	4 $\frac{1}{32}$ " x 1 $\frac{9}{16}$ "	HEATER	6.3	0.4	250	—
								250	250
								250	—
V-99 X-99	DETECTOR [★] AMPLIFIER TRIODE	SMALL 4-NUB SMALL 4-PIN	4E 4D	3 $\frac{3}{4}$ " x 1 $\frac{1}{16}$ " 4" x 1 $\frac{1}{16}$ "	D-C FILAMENT	3.3	0.063	90	—
112-A	DETECTOR [★] AMPLIFIER TRIODE	MEDIUM 4-PIN Bayonet	4D	4 $\frac{1}{16}$ " x 1 $\frac{13}{16}$ "	D-C FILAMENT	5.0	0.25	180	—
874	VOLTAGE REGULATOR	MEDIUM 4-PIN Bayonet	4S	5 $\frac{3}{8}$ " x 2 $\frac{3}{16}$ "	COLD	—	—	—	—
876	CURRENT REGULATOR	MOGUL SCREW	—	8" x 2 $\frac{1}{16}$ "	FILAMENT	—	—	—	—
886	CURRENT REGULATOR	MOGUL SCREW	—	8" x 2 $\frac{1}{16}$ "	FILAMENT	—	—	—	—

[★]For Grid-leak Detection—plate volts 45, grid return to + filament or to cathode.

[■]Either A. C. or D. C. may be used on filament or heater, except as specifically noted. For use of D. C. on A-C filament types, decrease stated grid volts by $\frac{1}{2}$ (approx.) of filament voltage.

ⁿSupply voltage applied through 20000-ohm voltage-dropping resistor.

[►]Mercury-Vapor Type.

^{••}Grid #1 is control grid. Grid #2 is screen. Grid #3 tied to cathode.

[†]Grid #1 is control grid. Grids #2 and #3 tied to plate.

^{•••}Grids #1 and #2 connected together. Grid #3 tied to plate.

^{••••}Grids #3 and #5 are screen. Grid #4 is signal-input control grid.

[▲]Grids #2 and #4 are screen. Grid #1 is signal-input control grid.

^{*}Triode Plate-Supply Voltage and Max. Target Voltage; Min. Target Voltage = 90 volts.

[•]Both grids connected together; likewise, both plates.

^{††}Power output is for two tubes at stated plate-to-plate load.

[◆]For two tubes.

[‡]This diagram is like the one having the same designation without the prefix G, except that Pin No. 1 has no connection.

Receiver Tube Characteristics 225

USE	PLATE SUPPLY VOLTS	GRID BIAS VOLTS	SCREEN SUPPLY VOLTS	SCREEN CURRENT MA.	PLATE CURRENT MA.	A-C PLATE RESISTANCE OHMS	TRANS-CONDUCTANCE (GRID-PLATE) μ MHOS	AMPLIFICATION FACTOR	LOAD FOR STATED POWER OUTPUT OHMS	POWER OUTPUT WATTS	TYPE
AMPLIFIER MIXER	For other characteristics, refer to Type 6U7-G.										58
TRIODE ∇ CLASS A AMPLIFIER	250	-28.0	—	—	26.0	2300	2600	6.0	5000	1.25	59
PENTODE $\bullet\bullet$ CLASS A AMPLIFIER	250	-18.0	—	9.0	35.0	40000	2500	100	6000	3.0	
TRIODE ∇ CLASS B AMPLIFIER	300	0	—	—	20.0 \clubsuit	—	—	—	4600	15.0 \dagger	71-A
CLASS A AMPLIFIER	400	0	—	—	26.0 \clubsuit	—	—	—	6000	20.0 \dagger	
CLASS A AMPLIFIER	90	-19.0	—	—	10.0	2170	1400	3.0	3000	0.125	75
TRIODE UNIT AS CLASS A AMPLIFIER	180	-43.0	—	—	20.0	1750	1700	3.0	4800	0.790	
CLASS A AMPLIFIER	90 \times	Self-bias, 11000 ohms	Grid Resistor, ** 0.5 megohm.				Gain per stage = 40				76
CLASS A AMPLIFIER	300 \times	Self-bias, 3900 ohms	Grid Resistor, ** 0.25 megohm.				Gain per stage = 53				
CLASS A AMPLIFIER	100	-5.0	—	—	2.5	12000	1150	13.8	—	—	77
CLASS A AMPLIFIER	250	-13.5	—	—	5.0	9500	1450	13.8	—	—	
BIAS DETECTOR	90 \heartsuit	Self-bias, 6500 ohms	Grid Resistor, ** 0.25 megohm.				Gain per stage = 9				78
BIAS DETECTOR	300 \heartsuit	Self-bias, 6400 ohms	Grid Resistor, ** 0.25 megohm.				Gain per stage = 10				
BIAS DETECTOR	250	-20.0 (approx.)	—	—	—	—	Plate current to be adjusted to 0.2 milliampere with no signal.				77
CLASS A AMPLIFIER	100	-1.5	60	0.4	1.7	650000	1100	715	—	—	
CLASS A AMPLIFIER	250	-3.0	100	0.5	2.3	1500000	1250	1500	—	—	77
BIAS DETECTOR	250	-1.95	50	—	—	—	Plate Resistor, 250000 ohms. Grid Resistor, ** 250000 ohms.				
AMPLIFIER MIXER	For other characteristics, refer to Type 6K7.										78
CLASS B AMPLIFIER	180	0	—	—	Power Output is for one tube at stated plate-to-plate load.				7000	5.5	79
CLASS B AMPLIFIER	250	0	—	—					14000	8.0	
For other ratings, refer to Type 5Y4-G.											80
Maximum A-C Plate Voltage.....700 Volts, RMS											81
Maximum D-C Output Current.....85 Milliampere											
Maximum A-C Voltage per Plate.....500 Volts, RMS											82
Maximum D-C Output Current.....125 Milliampere											
Maximum A-C Voltage per Plate.....500 Volts, RMS											83
Maximum D-C Output Current.....250 Milliampere											
Maximum Peak Plate Current.....1400 Volts											83-v
Maximum Peak Inverse Voltage.....1400 Volts											
Maximum Peak Plate Current.....800 Milliampere											
For other ratings, refer to Type 5V4-G.											83-v
Maximum A-C Voltage per Plate.....350 Volts, RMS											84/6Z4
Maximum D-C Output Current.....60 Milliampere											
TRIODE UNIT AS CLASS A AMPLIFIER	135	-10.5	—	—	3.7	11000	750	8.3	25000	0.075	85
CLASS A AMPLIFIER	250	-20.0	—	—	8.0	7500	1100	8.3	20000	0.350	
AS TRIODE ∇ CLASS A AMPLIFIER	160	-20.0	—	—	17.0	3300	1425	4.7	7000	0.30	89
CLASS A AMPLIFIER	250	-31.0	—	—	32.0	2600	1800	4.7	5500	0.90	
AS PENTODE $\bullet\bullet$ CLASS A AMPLIFIER	100	-10.0	100	1.6	9.5	104000	1200	125	10700	0.33	89
CLASS A AMPLIFIER	250	-25.0	250	5.5	32.0	70000	1800	125	6750	3.40	
AS TRIODE ∇ CLASS B AMPLIFIER	180	0	—	—	6.0 \clubsuit	—	—	—	13600	2.50 \dagger	V-99 X-99
CLASS B AMPLIFIER	—	—	—	—	—	—	—	—	9400	3.50 \dagger	
CLASS A AMPLIFIER	90	-4.5	—	—	2.5	15500	425	6.6	—	—	112-A
CLASS A AMPLIFIER	180	-13.5	—	—	7.7	4700	1800	8.5	—	—	
Minimum D-C Starting Supply Voltage.....125 Volts					D-C Operating Current.....10-50 Ma.						874
D-C Operating Voltage.....90 Volts					Maximum Current (Continuous).....50 Ma.						
Voltage Range.....40 to 60 Volts					Operating Current.....1.7 Amperes						876
Voltage Range.....40 to 60 Volts					Operating Current.....2.05 Amperes						886

†† This diagram is like the one having the same designation without the prefix G, except that Pin No. 1 is connected to internal shield.

\bullet Applied through plate resistor of 250000 ohms or 500-henry choke shunted by 0.25-megohm resistor.

\heartsuit Applied through plate resistor of 100000 ohms.

\times Applied through plate resistor of 250000 ohms.

\circ 50000 ohms.

$\#$ Requires different socket from small 7-pin.

\square Grid #2 tied to plate. \diamond Grids #1 and #2 tied together. $\bullet\bullet$ For grid of following tube.

∇ Plate voltages greater than 125 volts RMS require 100-ohm (minimum) series-plate resistor.

$\circ\circ$ Applied through plate resistor of 150000 ohms.

\clubsuit For signal-input control-grid (#1); control-grid #3 bias, -3 volts.

\blacksquare Applied through 200000-ohm plate resistor.

*Maximum.

‡Megohms.

Note 1: Types with octal bases have *Miniature Metal Cap*; all others have *Small Metal Cap*.

Note 2: Subscript 1 on class of amplifier service (as AB₁) indicates that grid current does not flow during any part of input cycle.

Subscript 2 on class of amplifier service (as AB₂) indicates that grid current flows during some part of the input cycle.

SOCKET CONNECTIONS

Bottom Views

KEY TO TERMINAL DESIGNATIONS OF SOCKETS

Alphabetical subscripts D, P, T, and HX indicate, respectively, diode unit, pentode unit, triode unit, and hexode unit in multi-unit types.

- | | | | |
|-------------------------|---------------------------|---|--------------------|
| BP = Bayonet Pin | H = Heater | P = Plate (Anode) | S = Shell |
| F = Filament | K = Cathode | P₁ = Starter-Anode | TA = Target |
| G = Grid | NC = No Connection | P_{BF} = Beam-Forming Plates | ● = Gas-Type Tube |

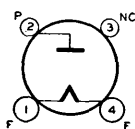

4B

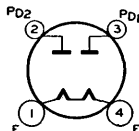

4C

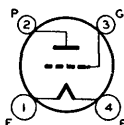

4D

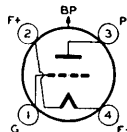

4E

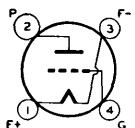

4F

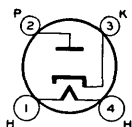

4G

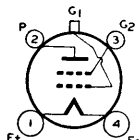

4K

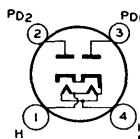

4L

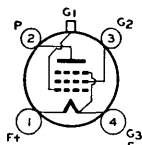

4M

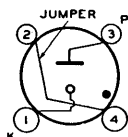

4S

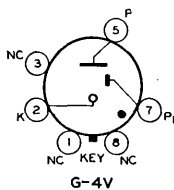

G-4V

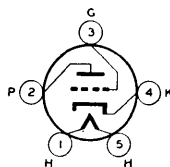

5A

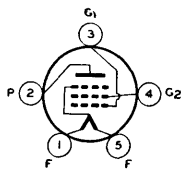

5B

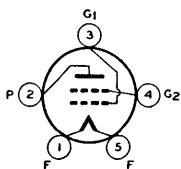

5C

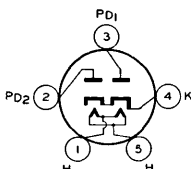

5D

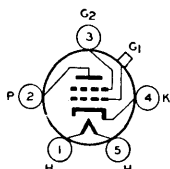

5E

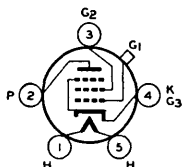

5F

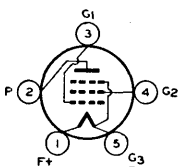

5K

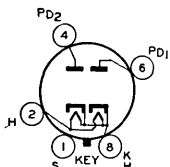

5L

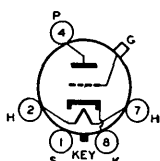

5M

SOCKET CONNECTIONS

Bottom Views

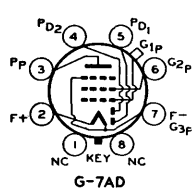
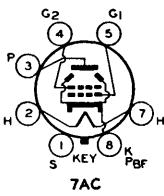
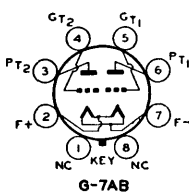
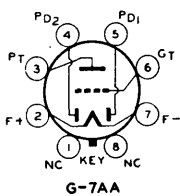
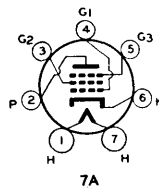
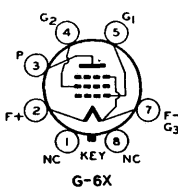
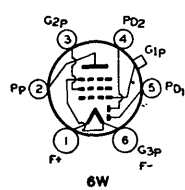
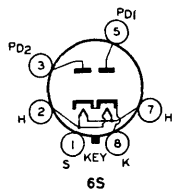
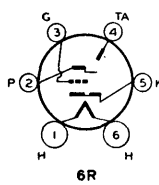
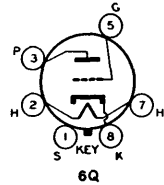
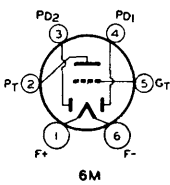
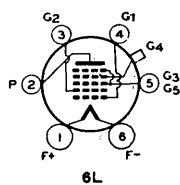
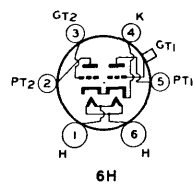
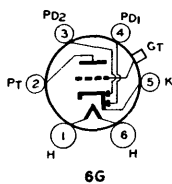
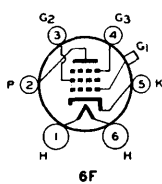
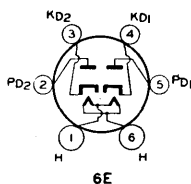
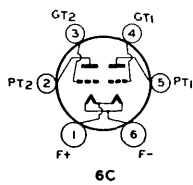
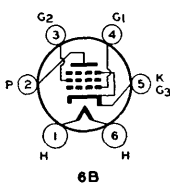
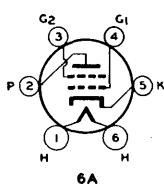
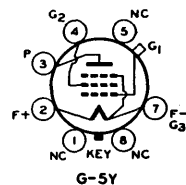
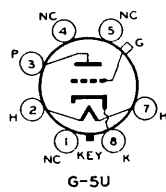
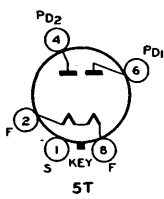
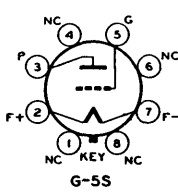
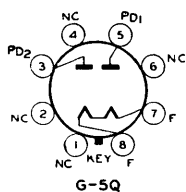

SOCKET CONNECTIONS

Bottom Views

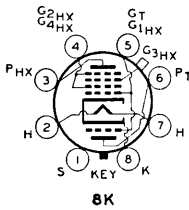
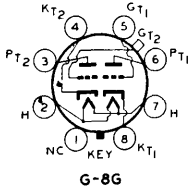
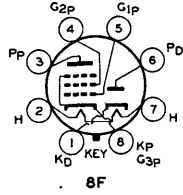
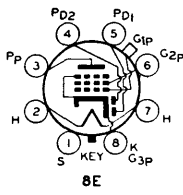
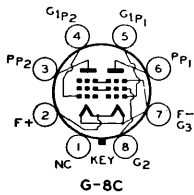
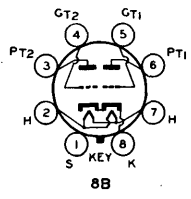
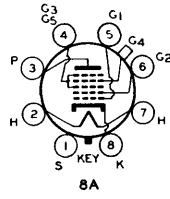
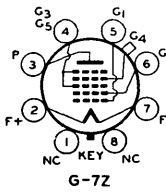
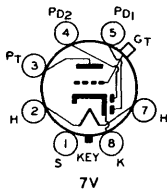
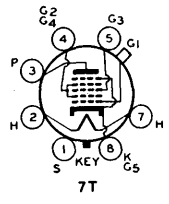
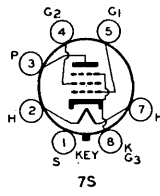
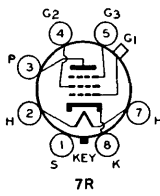
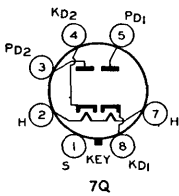
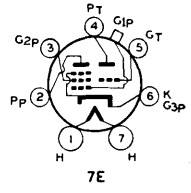
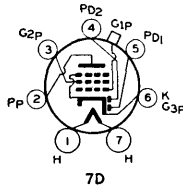
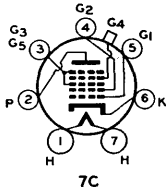
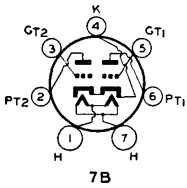

CHAPTER 10

Transmitting Tubes

Receiving Types Used in Transmitting — Transmitting Tubes — Rectifier Types — Special U.H.F. Tubes

SOME of the necessary information for determining the operating conditions of transmitter vacuum tubes is not generally found in technical bulletins which are supplied by tube manufacturers. For this reason it was necessary to compute certain of these data in RADIO'S laboratory; the findings are included along with the manufacturer's specifications in the pages which follow.

The typical operating conditions for class-B audio amplifiers or modulators and for r.f. amplifier service, are included. From this data the reader can tell at a glance what type of driver stage is needed, what the power supply requirements must be, the approximate output that can be expected and how the tube constants vary under certain operating conditions.

The ratings in the *Tube Tables* are for *safe values* of plate voltage and current. Amateurs who operate their transmitters at higher than normal tube ratings, without exceeding the actual plate dissipation ratings of the tubes, should remember that this condition of operation sometimes can be tolerated for *c.w. telegraphy only*, and with consequent increase in the required grid driving power, so that the tube can be operated over a lesser angle of plate current flow during each r.f. cycle. The d.c. grid current never should exceed the maximum rated value, yet the grid bias voltage may be increased to such an extent that from two to four times as much grid driving power is applied to the grid (or grids) of the tube (or tubes) in the final amplifier stage. This practice results in greater *plate efficiency* (within limits), but with a sacrifice in *power gain*.

In extreme cases, 200 watts of grid driving power would be required to obtain 600 watts of antenna power from the final r.f. amplifier stage. Thus, it can be seen that the foregoing does not represent economy in design; for this reason the *Tube Tables* in this *chapter* in general are based on a power gain of approximately 10, with plate efficiencies of from 66 per cent to 75 per cent. Radiation of harmonics will not be so troublesome when the class-C amplifier operates in this range of efficiencies, particularly when the C-to-L ratio of the tank circuit is chosen correctly.

The values of *grid driving power* shown in the *Tables* are those actually used by the grid of the tube. The power loss in the C-bias supply or grid leak should be added to these values. Circuit losses should be given consideration when designing buffer or amplifier stages for all-band operation. The tuned circuit losses are appreciably higher in the 10- and 20-meter bands than for operation at 80- or 160-meters. These circuit losses cannot be given in a tube table; only the grid bias loss and grid driving power can be listed. The driving stage should be capable of supplying some excess of power to compensate for circuit losses.

Many of the carbon plate tubes are easy to drive to high outputs. This is particularly true of the flat plate types, especially those designed for high-frequency operation. On the other hand, the inter-electrode capacities of tantalum plate tubes are lower than in comparable tubes which have carbon plates; thus, they are more efficient for operation at the higher frequencies and at

higher plate voltages. Both types can be made to operate with equal effectiveness in the most commonly used amateur bands.

Tantalum plate tubes are gas-free and can be operated at plate potentials as

high as 4,000 or 5,000 volts for one-kw. input to a single, relatively small tube; however, a more powerful driver is needed than for two equivalent carbon plate tubes operated at lower plate voltage and higher plate current.

THE TUBE TABLES

With the exception of small receiver-type tubes, all tubes for transmitter, modulator and audio application are listed in the tables in the order of their rated plate dissipation. Frequency range, interelectrode capacities, grid driving power, power output and average operating conditions are given. Power output and grid driving power requirements are given for average conditions where class-C amplifiers operate at an angle between 120° and 140°. The class-C plate efficiency will be between 66 per cent and 75 per cent under these conditions. Greater output and higher efficiency sometimes can be secured when more grid drive is available. The amplification factor (μ) determines the value of d.c. grid bias needed for the particular type of amplifier circuit in which the tube operates.

*Asterisk explanation: Types marked with an asterisk are especially recommended by the editors to amateurs designing new equipment. The tubes thus indicated offer the best performance per dollar and are somewhat better suited to the purposes for which they were designed than are older or more costly tubes of similar power output.

RECEIVER-TYPE TUBES

(for Crystal Oscillators and Low-Power Buffer-Doubler Service)

(Additional data on some of these types will be found in tables in the preceding chapter.)

RK-34 RAYTHEON twin-triode power amplifier. Designed primarily for u.h.f. amplifier or oscillator service. May be used efficiently up to 240 Mc., providing the plate dissipation is not allowed to exceed 10 watts.

Note: A fixed bias of -15 volts is desirable in case of failure of r.f. excitation.

Unusual Feature: Two plate leads are brought through the top of the tube envelope, thus reducing interelectrode capacities for u.h.f. service.

Characteristics:	
Heater Voltage	6.3 volts
Heater Current	0.8 amps.
Amplification Factor	13
Grid-to-Plate Capacitance	2.7 μ fd.
Input Capacitance	4.2 μ fd.
Output Capacitance	2.1 μ fd.
Max. Plate Dissipation	10 watts
Max. D.C. Plate Voltage	300 volts
Max. D.C. Plate Current80 ma.
Max. D.C. Grid Current25 ma.

R.F. Service—Class C Amplifier:	
D.C. Plate Voltage	300 volts
D.C. Grid Voltage	-45 volts
D.C. Plate Current75 ma.
D.C. Grid Current15 ma.
Grid Driving Power	1.8 watts

Grid Bias Loss	0.67 watts
Power Input14 watts
Approx. A.C. Load Impedance	1600 ohms

19 Twin-triode class-B audio amplifier for portable radio receivers. Class-B modulator in portable u.h.f. transmitters and transceivers. U.h.f. oscillator in push-pull circuits. Occasionally used as a crystal oscillator or r.f. amplifier in portable transmitters. Specifications in previous chapter.

Characteristics:	
Filament Voltage (D.C.)	2.0 volts
Filament Current	0.26 amps.

2A3-6A3 Triode power amplifier. Normally used in push-pull in radio receivers and as a p.p. driver stage for class-B modulators which have outputs of from 100 to 300 watts. The low plate resistance makes these tubes desirable as class-B stage drivers. Sometimes operated as a class-C r.f. amplifier in radio transmitters, in which case the maximum plate voltage is 400 volts. The 6A3 is similar to the 2A3, except for its heat-

er, which is rated at 6.3 volts and one ampere. Data for audio applications in previous chapter.

Note: As a class-C r.f. amplifier, approx. 15% more output can be obtained than from a 45 tube. Not recommended for class-C service above 7 Mc.

Characteristics:

Filament Voltage2.5 volts
Filament Current2.5 amps.
Grid-to-Plate Capacitance13 $\mu\mu\text{fs}$.
Input Capacitance9 $\mu\mu\text{fs}$.
Output Capacitance4 $\mu\mu\text{fs}$.
Plate Resistance800 ohms
Amplification Factor4.2
Mutual Conductance5250 micromhos

2B6 Power amplifier for radio receivers. More often used as a crystal oscillator-amplifier or doubler in radio transmitters.

Unusual Characteristics: Two triodes in one envelope. The power amplifier grid is direct-coupled to the driver cathode, and the driver plate connects directly to plus B.

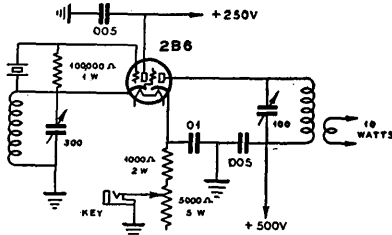

2B6 "LES-TET" CRYSTAL OSCILLATOR-DOUBLER WHEN SECOND TRIODE IS USED AS AN R F AMPLIFIER IT MUST BE NEUTRALIZED

30 Triode detector. Audio amplifier and oscillator for battery-operated radio receivers. Also used in 5-meter transceivers. Sometimes used as a crystal oscillator or amplifier, in portable transmitters. Refer to previous chapter.

Characteristics:

Filament Voltage (D.C.)2.0 volts
Filament Current06 amp.
Grid-to-Plate Capacitance6.0 $\mu\mu\text{fs}$.
Input Capacitance3.0 $\mu\mu\text{fs}$.
Output Capacitance2.1 $\mu\mu\text{fs}$.
Basesmall 4-pin

RK-42 RAYTHEON triode for portable sets. Similar to type 30, except for filament.

Filament Voltage1.5 volts
Filament Current06 amp.

RK-43 RAYTHEON high-mu twin-triode for class-B service. Each triode is somewhat similar to RK-42, except for higher mu.

Filament Voltage1.5 volts
Filament Current12 amp.

42-6F6-2A5* Pentode Power Amplifier for radio receivers. 2.5-volt equivalent of glass 42 tube is 2A5, with filament current of 1.7 amp.

- (1) Single or push-pull audio amplifier for radio receivers (pentode).
 - (2) Crystal oscillators in transmitters.
 - (3) Frequency doublers in transmitters.
 - (4) Triode driver stage or class-AB push-pull power amplifier.
- (See 6L6 applications for other uses.)

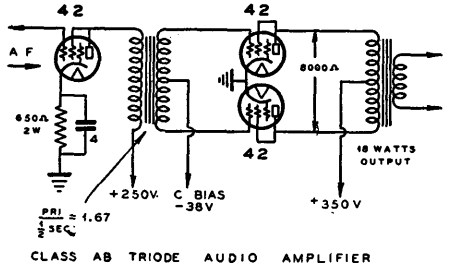

CLASS AB TRIODE AUDIO AMPLIFIER

45 Equivalent to metal tube 6D5. Triode Power Tube for push-pull class-A or AB service. The output in class-AB is sufficient to drive class-B modulators of 100 to 200 watts output. Also useful as a low-power r.f. buffer tube in transmitters. Refer to previous chapter for data on audio applications.

Class-C R.F. Amplifier:

Plate Voltage400 volts
Plate Current50 ma.
Peak Plate Current (A.C.)90 ma.
Grid Bias Voltage-200 volts
Grid Bias Current4 ma.
Plate Power Input20 watts
Grid Power Input1.0 watt
Grid Bias Power Loss0.8 watt
Power Output15 watts
Efficiency75%
Plate Load Impedance3700 ohms

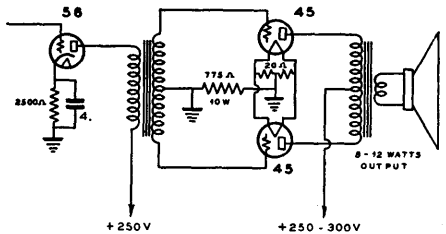

Low-distortion audio amplifier for radio receivers.

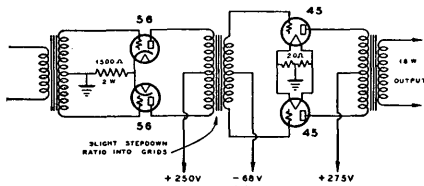

Push-pull class-AB amplifier for class-B driver or p.a. service.

46 Class-B amplifier for radio receivers and public address systems. More often used in modulator systems for small radio-telephone transmitters. Frequently serves as a doubler in r.f. circuits of radio transmitter. Refer to previous chapter for data on audio applications.

Note: Audio peak outputs of 40 watts for speech can be secured if a 500-volt plate supply is available, although this exceeds the manufacturers' ratings of 400-volt plate supply.

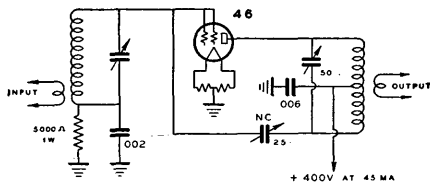

INPUT REQUIRED 1.6 WATTS - AS AN AMPLIFIER - 10 WATTS
2.3 " - AS A DOUBLER - 5 "

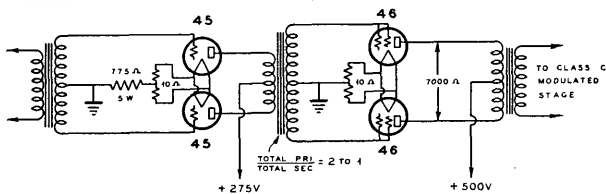

CLASS B MODULATOR FOR PHONE TRANSMITTER
AVERAGE POWER OUTPUT 20 WATTS-PEAK OUTPUT 40 WATTS

47 Audio power amplifier for radio receivers or modulator service in small a.c.-operated 5-meter transmitters. Crystal oscillator in radio transmitters. Specifications in previous chapter.

Note: This tube has been replaced for most services by tubes with a separate cathode and heater, such as the 2A5.

RCA-1602 Amplifier triode. Low microphonic construction. Similar in characteristics to the RCA-10.

RCA-1603 Triple grid detector-amplifier. Non-microphonic, noise design. Used as a pentode or as a triode (grids 2 and 3 connected to plate) with a μ of 20. See 6J7 for characteristics. Similar to 6C6 in size.

RCA-1608 Triode transmitting tube for operation at normal ratings up to 45 Mc. May be used as an r.f. amplifier, frequency doubler or in a class-B modulator.

Characteristics:

Filament Voltage2.5 volts
Filament Current2.5 amps.
Amplification Factor20
Grid-to-Plate Capacitance9 μ fds.
Grid-to-Filament Capacitance8.5 μ fds.
Plate-to-Filament Capacitance3 μ fds.
Maximum Plate Dissipation20 watts
Max. Sig. D.C. Plate Current95 ma.
Max. D.C. Plate Voltage425 volts
BaseStandard 4-pin ceramic

RCA-1609 Battery-type pentode incorporating low microphonic design for speech amplifier application. 5-prong base.

Filament Voltage1.1 volts
Filament Current0.25 amp.
Maximum D.C. Plate Voltage135 volts
Maximum D.C. Screen Voltage67.5 volts

RCA-1610 Pentode crystal oscillator tube having characteristics and tube base identical to that of type 47.

RCA-1619 Transmitting beam power amplifier having characteristics similar to 6L6 except for 2.5-volt 2-ampere quick-heating filament. See 6L6 for operating characteristics and applications.

59 Triple - grid pentode amplifier. Class-A audio amplifier. Triode class-A driver for 59 class-B stage. Crystal oscillator and frequency-doubler in radio transmitters. Specifications in previous chapter.

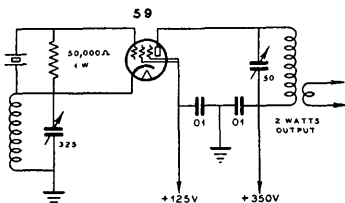

TRITET CRYSTAL OSCILLATOR - DOUBLER

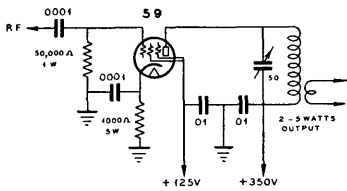

REGENERATIVE FREQUENCY DOUBLER
(CATHODE CONDENSER TYPE)

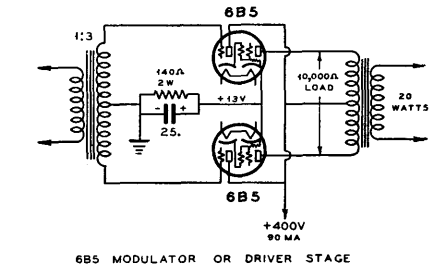
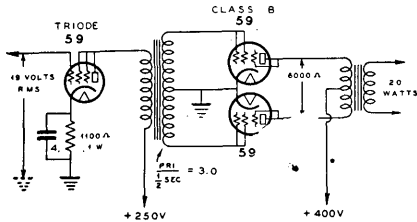

6B5 MODULATOR OR DRIVER STAGE

6A6-53

Equivalent metal tube — 6N7. Type 53 is identical in characteristics, except for its heater which is rated at 2.5 volts at 2 amps. Twin triode power tube designed for class-B audio amplifiers in radio receivers. Also very useful as crystal oscillator and frequency doubler in transmitters for frequencies up to 30 Mc. Often used in 5-meter transmitters and receivers as oscillators and detectors. Specifications in previous chapter.

Precautionary Measures: 300-volt plate supply is maximum as a class-B audio amplifier. As an r.f. oscillator or doubler, the plate potential must not exceed 400 volts if cathode bias is used, and not over 300 for grid leak bias. For r.f. purposes, the d.c. plate current per plate should not exceed 35 ma. and excessive grid excitation should be avoided.

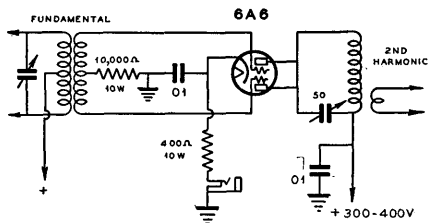

6A6 push-push r.f. frequency doubler.

6B5

Equivalent Tubes — 6N6G, 6N6. Glass tube special power amplifier. Designed for power amplifier use in the output stage of a radio receiver. Can be

used in push-pull for outputs as high as 20 watts in small power amplifiers or modulators. Due to the gain within the double triode tube, the input grid does not need to be driven beyond class A, and a 76 tube will drive a pair of 6B5 tubes to 20 watts output. Refer to 6N6 data in previous chapter.

Unusual Characteristics: An internal grid of the power output triode is direct-coupled to an internal cathode. No external connections are necessary, and the small triode drives the large triode in class AB.

6L6-6L6G*

Purpose: Designed primarily for push-pull amplifier in radio receivers but also widely used in crystal oscillators and r.f. amplifiers for radio transmitters.

Unusual Characteristic: Has two beam-forming plates internally connected to the cathode. Has no physical suppressor grid. The beam action suppresses secondary emission and results in a more ideal pentode operation.

Precautionary Measures: Good air ventilation is desirable because the tube shell becomes very hot under normal operation. In push-pull circuits, balanced tubes are necessary, as well as balanced transformers if second harmonic elimination is desired.

Audio Amplifier Application: If not over 34 watts of audio output is required, a single 6C5 audio amplifier or power detector will drive a pair of 6L6 tubes in push-pull. A 1-to-2 or 1-to-3 step-up interstage transformer is suitable. For outputs of over 34 watts, push-pull 6C5 tubes are suitable for drivers, with a 1-to-1/2 ratio interstage transformer (primary to 1/2 secondary). The output transformer should be of large size in order to handle up to 60 watts of audio power without core saturation. May be used as a modulator for phone transmitters.

Feedback Amplifier Application: Reverse feedback operation in a receiver amplifier will damp out low-frequency loudspeaker resonance. The result is similar in action to a triode, but the d.c. efficiency of a pentode is retained without much sacrifice in power sensitivity. Part of the output is fed back to the grid circuits in reverse phase in order to produce the effect of lower plate impedance.

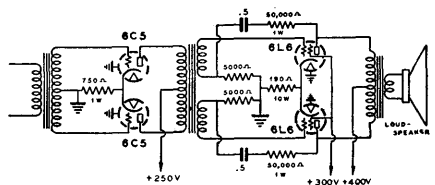

REVERSED FEEDBACK AUDIO AMPLIFIER FOR HIGH QUALITY RECEIVERS

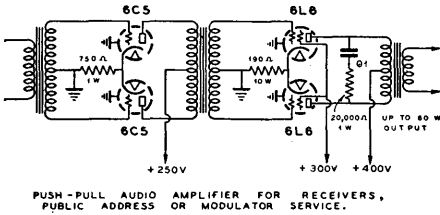

PUSH-PULL AUDIO AMPLIFIER FOR RECEIVERS, PUBLIC ADDRESS OR MODULATOR SERVICE.

Crystal Oscillator Application: The crystal r.f. current is very low due to the high power sensitivity of this tube. Outputs of 15 watts can be obtained as a crystal oscillator without exceeding tube ratings.

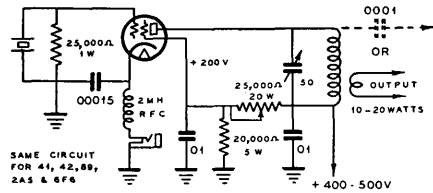

SAME CIRCUIT FOR 41, 42, 89, 2A5 & 6F6

6L6 CRYSTAL OSCILLATOR WITH CATHODE REGENERATION

This circuit can also be used with 41, 42, 2A5, 89 and 6F6 tubes.

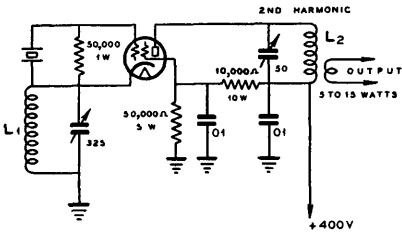

6L6 TRITODE OR DODECA CRYSTAL OSCILLATOR

The same circuit is also suitable for 41, 42, 2A5, 89 and 6F6 tubes.

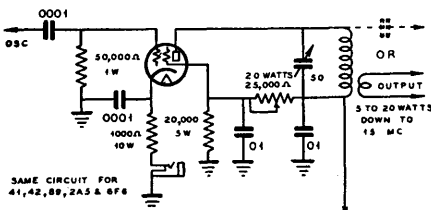

6L6 REGENERATIVE R F DOUBLER

Circuit also suitable for other tubes, such as 41, 42, 2A5, 89 and 6F6.

R.f. Applications: The 6L6 is suitable for a low-power frequency doubler in transmitters. Due to high sensitivity and harmonic output, only a small amount of power is required to drive the grid as a doubler for outputs of 20 watts and more for frequencies as high as 15 Mc.

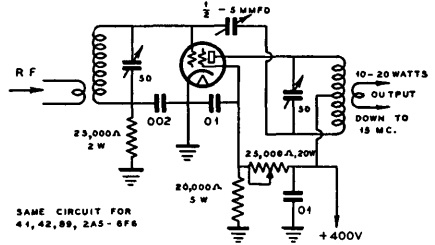

SAME CIRCUIT FOR 41, 42, 89, 2A5 - 6F6

6L6 NEUTRALIZED R F BUFFER OR DOUBLER

41, 42, 2A5, 89 or 6F6 tubes can be used in same circuit.

Single-ended amplifier: Because of its inherent characteristics, the 6L6 produces bad harmonic distortion when used as a single-ended audio amplifier at high volume levels. This distortion may be minimized by deliberately generating out-of-phase distortion in the preceding audio amplifier stage as illustrated in the accompanying diagram.

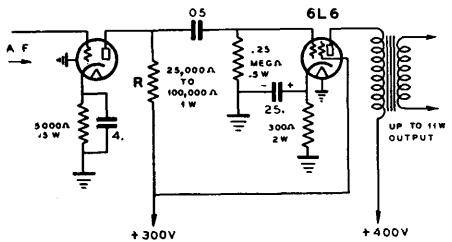

6L6 audio amplifier with 6F5 driver. Low values of "R" tend to generate out-of-phase second harmonic which cancels distortion of 6L6 as single-tube audio amplifier.

89 Triple-grid power amplifier. Designed for storage battery operation, such as in automobile radio receivers. Can be used with a.c. supply. Occasionally used as an electron-coupled or crystal oscillator in short-wave transmitters. Specifications in previous chapter.
 Note: The triple-grid construction makes operation possible as a class-A triode or pentode amplifier and as a class-B triode.

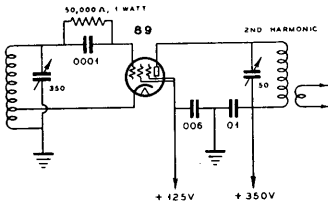

Electron coupled oscillator.

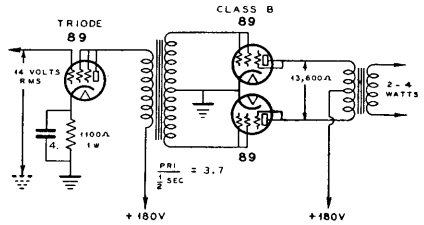

Modulator for mobile transmitter.

TRANSMITTING TYPE TUBES

RK-23-25 RAYTHEON r. f. amplifier, frequency doubler, oscillator, suppressor-, control grid- or plate-modulated amplifier. As a doubler, approx. 12 watts can be obtained. This tube has large 7-pin base. Plate at top of tube.

Frequency Range: 100% ratings up to 30 Mc.

Characteristics:	RK-23	RK-25
Heater Voltage	2.5	6.3 volts
Heater Current	2.0	0.8 amp.
Grid-Plate Cap.	0.2	$\mu\text{fds.}$
Input Capacitance	0.10	$\mu\text{fds.}$
Output Capacitance	0.10	$\mu\text{fds.}$
Max. Plate Dissipation	0.8	watts

R.F. Service:

	Control Grid Modulation	Supp. Mod.	Class-C Telegraphy	
D.C. Plate Voltage	500	500	500	500 v.
D.C. Screen Voltage	200	200	200	200 v.
D.C. Suppress. Voltg.	45	-45	0	45 v.
D.C. Grid Voltage	-125	-90	-90	-90 v.
Peak R.F. Grid Voltage	150	135	135	135 v.
Peak A.F. Grid Voltage	45	75
D.C. Plate Current	34	32	50	55 ma.
D.C. Screen Current	20	40	40	35 ma.
D.C. Grid Current	1.5	6	6	6 ma.
Grid Driving Power	1.3	.8	.8	.8 watts
Grid Bias Loss	.2	.5	.5	.5 watts
Pwr. Output (Approx.)	6.5	5.5	18	24 watts
Screen Resistor	20,000	7500	7500	8500 ohms

RK-44 Raytheon pentode, similar to RK-25, except for somewhat higher ratings. Designed for aircraft and mobile service.

Heater Voltage	12.6 volts
Heater Current	0.7 amps.
Maximum D.C. Plate Voltage	650 volts
Maximum D.C. Plate Current	80 ma.
Class-C Output	30 watts

RK-45 Raytheon pentode, identical to RK-25, except for heater, which operates at 12.6 volts and 0.45 amps. Designed for aircraft and mobile transmitters.

842 RCA audio-frequency amplifier and modulator. Triode. Not as desirable as a type 2A3, which will provide more output at lower plate voltage. Primarily for replacement service in commercial equipment.

Characteristics:

Filament Voltage	7.5 volts
Filament Current	1.25 amps.
Grid-Plate Capacitance	7 $\mu\text{fds.}$
Grid-Filament Capacitance	4 $\mu\text{fds.}$
Plate-Filament Capacitance	3 $\mu\text{fds.}$
Amplification Factor	3
Max. Plate Dissipation	12 watts
Max. Plate Voltage	425 volts
Base	4-pin

10 Triode, Class-C amplifier or doubler. Class-B power amplifier and modulator for medium-power transmitters. Crystal oscillator in commercial transmitters (at 250 volts max. plate supply). Often operated at 750 to 900 volts plate supply and 75 ma. per tube in class-C telegraphy, amateur service.

Frequency Range: Up to 15 Mc. at normal ratings. May be operated on frequencies as high as 60 Mc. at reduced plate voltage (400 volts) if tube is equipped with ceramic base, or if molded bakelite bases are cross-slotted with hack-saw cut.

Characteristics:

Filament Voltage	7.5 volts
Filament Current	1.25 amps.
Plate Voltage	350
Grid Voltage	-31
Plate Current	16
Plate Resistance	5150
	425 max. volts
	-39 max. volts
	18 ma.
	5000 ohms

Amplification Factor	8	8
Mutual Conductance	1550	1600 micromhos.
Load Resistance	11,000	10,200 ohms
Self-Bias Resistance	1950	2150 ohms
Power Output	0.9	1.6 watts
Plate-Grid Cap.		7 μ fds.
Input Capacitance		4 μ fds.
Output Capacitance		3 μ fds.
Base		Medium 4-pin

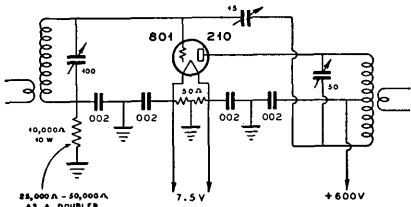

210 or 801 buffer-doubler circuit with split plate coil, requiring minimum grid drive under load.

Class-C Amplifier (Telegraphy):

D.C. Plate Voltage	400	500	600 v.
D.C. Plate Current	65	65	65 ma.
D.C. Grid Voltage	-100	-125	-150 v.
D.C. Grid Current	1.0	1.0	1.2 ma.
Approx. A.C. Load Imped.	3000	3800	4800 ohms
Approx. Power Output			27 watts
R.F. Grid Excitation	2.7	3.0	3.8 watts
Grid Bias Loss	1.0	1.25	1.8 watts
Plate Loss	10	11.5	12 watts

Class-B, A.F. Amplifier:

Plate Voltage	400	600 v.
Grid Bias	-50	-75 v.
Zero Sig. Plate Current (Per Tube) ..	4	4 ma.
Max. Sig. Plate Current (Per Tube) ..	65	65 ma.
Load Resistance (Plate to Plate)	6000	10,000 ohms
Approx. Power Output (2 Tubes) ...	27	45 watts

802 RCA pentode. R.F. amplifier, frequency doubler, oscillator; suppressor, grid or plate-modulated amplifier. Plate at top of tube.

Frequency Range: 100% up to 30 Mc., 55% at 60 Mc.

Note: The internal shield should connect to cathode at the socket, in all circuits.

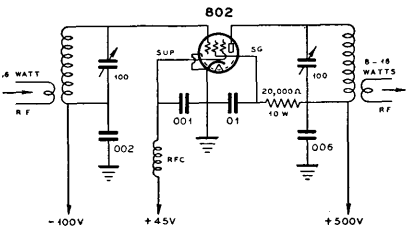

802 Pentode low-power buffer stage.

Characteristics:

Heater Voltage	6.3 volts
Heater Current	0.8 amp.
Grid-to-Plate Capacitance	0.15 μ fds.
Input Capacitance	12 μ fds.
Output Capacitance	8.5 μ fds.

Max. Plate Dissipation	10 watts
Max. Screen Dissipation6 watts
Base	7-pin, large

R.F. Service:

	Grid Modulation	Supp. Mod.	Class-C Teleg.	
D.C. Plate Voltage ..	500	500	500	500 volts
D.C. Screen Voltage..	200	200	200	200 volts
D.C. Suppress. Voltg.	0	-45	0	40 volts
D.C. Grid Voltage...	-130	-90	-100	-100 volts
Peak R.F. Grid Voltg.	145	125	155	135 volts
Peak A.F. Grid Voltg.	50	65
D.C. Plate Current...	25	22	45	45 ma.
D.C. Screen Current...	8	28	22	12 ma.
D.C. Grid Current...	1	4.5	6	2 ma.
Grid Driving Power...	.8	.5	.9	.25 watts
Grid Bias Loss.....	.13	.4	.6	.2 watts
Pwr. Output (Approx.)	4	3.5	14	16 watts
Screen Resistor.....	37,500	10,700	13,700	20,000 ohms

837 RCA pentode amplifier designed primarily for 12-volt storage battery power supplies (aircraft, marine, etc.)

Characteristics:

Heater Voltage	12.6 volts
Heater Current	0.7 amp.
Grid-to-Plate Capacitance	0.2 μ fds.
Input Capacitance	16 μ fds.
Output Capacitance	10 μ fds.
Maximum D.C. Plate Voltage.....	500 volts
Maximum D.C. Screen Voltage.....	200 volts
Maximum Plate Dissipation.....	12 watts
Maximum Plate Input.....	32 watts
Maximum D.C. Plate Current	80 ma.
Base	Medium 7-pin ceramic. Plate through top of bulb.

R.F. Amplifier Service:

	Suppress. Mod.	Plate-Mod. Pentode	Class-C Teleg.
D.C. Plate Voltage	500	400 max.	500 volts
D.C. Screen Voltage	200	140	80 volts
D.C. Grid Voltage	-20	-70	-70 volts
D.C. Plate Current	30	45	60 ma.
D.C. Screen Current	23	30	15 ma.
D.C. Grid Current	3.5	7	8 ma.
D.C. Suppressor Voltage.....	-65	+40	...
Screen Resistor	14,000	10,000	28,000 ohms
Driving Power	0.1	0.7	0.7 watts
Power Output	5	11	20 watts

WE-307A WESTERN ELECTRIC pentode. Oscillator, high-frequency amplifier and doubler, suppressor-modulated amplifier. Designed for portable h.f. and u.h.f. transmitters.

Frequency Range: 100% ratings up to approx. 60 Mc.

Unusual Feature: Quick-heating filament instead of heater for intermittent use in automobile transmitters.

Characteristics:

Filament Voltage	5.5 volts
Filament Current	1.0 amps.
Grid-to-Plate Cap.	0.55 μ fds.
Input Cap.	15 μ fds.
Output Cap.	12 μ fds.
Max. Plate Dissipation	15 watts

R.F. Service:

	Suppress. Mod.	Class-C Teleg.
D.C. Plate Voltage	500	500 v.
D.C. Screen Voltage	200	200 v.
D.C. Suppressor Voltage	-50	00 v.
D.C. Grid Voltage	-35	-35 v.
Peak R.F. Grid Voltage	50	50 v.
Peak A.F. Grid Voltage	50	00 v.
D.C. Plate Current	40	52 ma.
D.C. Screen Current	21	18 ma.
Power Output (Approx.)	6	17 watts
Screen Resistor	14,000	14,000 ohms

841 RCA, AMPEREX, United, High- μ (¹⁰) triode, Class-B modulator, Class-C r.f. amplifier or doubler, Oscillator, Resistance-coupled audio amplifier, Primarily for replacement; superseded by TZ-20, 809, etc.

Frequency Range: 100% ratings up to 6 Mc. New ceramic base types may be operated up to 30 Mc. at full ratings.

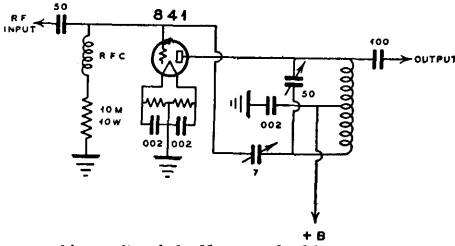

Neutralized buffer or doubler stage.

Characteristics:

Filament Voltage	7.5 volts
Filament Current	1.25 amps.
Amplification Factor	80
Grid-to-Plate Capacitance	7 μ fds.
Grid-to-Filament Capacitance	4 μ fds.
Plate-to-Filament Capacitance	3 μ fds.
Maximum Plate Dissipation	15 watts
Maximum D.C. Plate Voltage	450 volts
Maximum D.C. Plate Current	60 ma.
Maximum D.C. Grid Current	20 ma.
Base	UX 4-pin

843 RCA triode. Oscillator, a.f. power amplifier and r.f. amplifier of the heater-cathode type for 2.5-volt filament supply. Not in general use.

Frequency Range: 100% ratings up to 6 Mc. 50% at 30 Mc.

Characteristics:

Heater Voltage	2.5 volts
Heater Current	2.5 amps.
Amplification Factor	7.7
Grid-to-Plate Capacitance	6 μ fds.
Grid-to-Cathode Capacitance	5 μ fds.
Plate-to-Cathode Capacitance	5 μ fds.
Maximum D.C. Plate Voltage	450 volts
Maximum D.C. Plate Dissipation	15 watts
Maximum D.C. Plate Current	40 ma.
Maximum D.C. Grid Current	7.5 ma.
Base	UX 5-pin

844 RCA screen-grid r.f. amplifier — doubler or buffer. Oscillator. Not in general use.

Characteristics:

(Heater-Cathode Type)	
Heater Voltage	2.5 volts
Heater Current	3.25 amps.
Amplification Factor	75
Grid-to-Plate Capacitance	0.15 μ fds.
Input Capacitance	9.5 μ fds.
Output Capacitance	7.5 μ fds.
Maximum Plate Dissipation	15 watts
Maximum Screen Dissipation	3 watts
Maximum D.C. Plate Voltage	500 volts
Maximum D.C. Plate Current	80 ma.
Maximum D.C. Grid Current	5 ma.
Base	UX 5-pin

R.F. Service

	Class-B Tele- phony	Plate Mod. Class C	Class-C Telegraphy
D.C. Plate Voltage	500	500	400
D.C. Screen Voltage	180	150	175
D.C. Grid Current	-40	-100	-125
D.C. Plate Current	20	20	25
Power Output	3	4	6
			9 watts

865 RCA screen-grid tetrode. Buffer, amplifier, and frequency doublers. As a doubler about 5 to 10 watts may be obtained. Used primarily in commercial and government transmitters and for replacement service; superseded by 802, 807, etc.

Characteristics:

Filament Voltage	7.5 volts
Filament Current	2.0 amps.
Grid-to-Plate Capacitance	0.10 μ fds.
Input Capacitance	8.5 μ fds.
Output Capacitance	8.5 μ fds.
Plate Voltage	500 volts
Screen Voltage	125 volts
Grid Voltage	0 volts
Amplification Factor	130
Plate Resistance	200,000 ohms
Mutual Conductance	750 micromhos
Plate Current	21 ma.
Maximum Plate Dissipation	15 watts
Base	4-pin. Plate through top of envelope

Class-C Operation:

D.C. Plate Voltage	500	750 volts
D.C. Plate Current	50	40 ma.
D. C. Screen Voltage	125	125 volts
D.C. Grid Voltage	-80	-80 volts
D.C. Grid Current	9	5.5 ma.
Grid Driving Power (Approx.)	2.0	1.0 watts
Grid Bias Power Loss	.7	.45 watts
Plate Power Input	25	30 watts
Power Output (Approx.)	10	16 watts

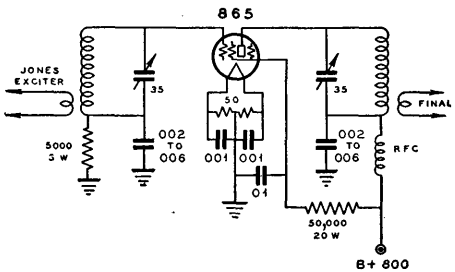

Single 865 buffer or doubler circuit.

T20* TAYLOR h.f. triode. General purpose, high- μ ; suitable for frequencies up to 56 Mc. Suitable for class-B audio service, or as an r.f. frequency-doubler or r.f. amplifier. Isolantite-based tube with plate through top of envelope. 4-pin base. Molybdenum plate. Greater plate dissipation than type 10 or 841 triode.

Characteristics:

Filament Voltage	7.5 volts
Filament Current	1.75 amps.
Amplification Factor	20
Grid-to-Plate Capacitance	4 μ fds.
Maximum Plate Dissipation	20 watts
Maximum D.C. Plate Voltage	750 volts

238 RADIO Handbook

Maximum D.C. Plate Current.....75 ma.
Maximum D.C. Grid Current.....25 ma.

Class-B Modulator or A.F. Amplifier (2 Tubes)
D.C. Plate Voltage.....800 600 volts
D.C. Grid Voltage.....-40 -30 volts
Zero Sig. Plate Current (Per Tube) 10 10 ma.
Maximum Signal Plate Current (Per Tube) 68 70 ma.
Load Resistance (Plate-to-Plate) 12,000 8100 ohms
Power Output 70 50 watts

Class-C Amplifier:
D.C. Plate Voltage.....750 voltage
D.C. Grid Voltage.....-100 volts
D.C. Plate Current.....75 ma.
D.C. Grid Current.....20 ma.
Grid Driving Power (Approx.).....3 watts
Grid Bias Loss.....2 watts
Power Output (Approx.).....42 watts

TZ-20 * TAYLOR h.f. triode. Primarily designed for zero-bias class-B audio use. Also suitable for all r.f. uses for which the T-20 is suitable. Operating conditions for r.f. use of the TZ-20 will be similar to those of the T-20; the grid bias, however, will be somewhat lower in each case. An improved doubler over the T-20. Isolantite base, metal plate, plate lead through top.

Characteristics:
Filament Voltage.....7.5 volts
Filament Current.....1.75 amps.
Amplification Factor.....62
Average Plate Resistance.....26,700 ohms
Mutual Conductance.....2320 μ hos

Class-B Audio Amplifier or Modulator:
D.C. Plate Voltage.....800 600 volts
Grid Bias Voltage.....0 0 volts
Zero-signal Plate Current.....20 14 ma.
Max.-signal Plate Current.....69 70 ma.
Load Res., Plate-to-Plate.....12,000 8100 ohms
Power Output, Two Tubes.....70 50 watts

Radio-Frequency Amplifier Service:
See operating conditions for T-20.

801 RCA, AMPEREX, UNITED 310, Triode, Class-C R-f amplifier for phone or c.w. Class-B modulators. Frequency doubler. An improved type 10.

Caution: The values given for grid driving power and power output vary with frequency and load circuit impedance. The driving stage should be designed to have twice as much power output as needed for grid driving power and bias supply loss.

Note: As a doubler, regeneration can be obtained at the output frequency to improve the output efficiency without requiring as high grid bias and grid drive as listed in the table.

Characteristics:
Filament Voltage.....7.5 volts
Filament Current.....1.25 amps.
Amplification Factor.....8
Grid-to-Plate Capacitance.....6.0 μ fd.
Grid-to-Filament Capacitance.....4.5 μ fd.
Plate-to-Filament Capacitance.....1.5 μ fd.
Maximum Plate Dissipation.....20 watts
Maximum D.C. Plate Voltage.....600 volts
Maximum D.C. Plate Current.....70 ma.
Maximum D.C. Grid Current.....15 ma.
Base.....UX 4-pin Isolantite

Class-B Audio:
Plate Voltage.....400 500 600 750 volts
Grid Voltage (Approx.).....-50 -60 -75 -90 volts
Zero Sig. Plate Current (Per Tube) 4 5 4 6 ma.
Maximum Sig. Plate Current (Per Tube) 65 65 65 65 ma.
Load Resistance (Plate-to-Plate) 6000 8000 10,000 12,000 ohms
Power Output 27 36 45 60 watts

Class-C Operation, Amplifier:
D.C. Plate Voltage.....500 500 600 750 volts
D.C. Grid Bias.....-190 -125 -150 -190 volts
D.C. Plate Current.....55 65 65 65 ma.
D.C. Grid Current.....15 10 15 15 ma.
Grid Driving Power (Approx.).....4.5 2.2 4 5.3 watts
Bias Supply Power Loss 2.9 1.2 2.25 2.9 watts
Power Output (Approx.) 18 16 25 35 watts
Approximate A.C. Load Resistance.....4300 3600 4500 5500 ohms
D.C. Modulator Load 9100.....ohms

Frequency Range.....60 90 120 150 megacycles
Class-C Telephony.....480 360 310 260 volts
Class-C Telegraphy.....600 455 390 330 volts

	No Regen-eration	With Regeneration
D.C. Plate Voltage.....	600	600 volts
D.C. Plate Current.....	75	75 ma.
D.C. Grid Voltage.....	-495	-250 volts
D.C. Grid Current.....	8	10 ma.
Grid Driving Power.....	4.75	8.5 watts
Grid Bias Supply Loss.....	4	2.5 watts
Power Output (Approx.).....	25	25 watts
Plate Loss.....	20	20 watts

RCA-1608 Coated filament triode, similar to RCA-801, but with a higher amplification factor.

Characteristics:
Filament Voltage.....2.5 volts
Filament Current.....2.5 amps.
Amplification Factor.....20
Maximum D.C. Plate Voltage.....425 volts
Maximum D.C. Plate Current......95 ma.
Class-C R.F. Output.....27 watts
Class-B Linear Output.....10 watts
Class-B Audio (Two Tubes).....50 watts

807 R.C.A. beam power pentode transmitter tube. R.f. buffer or doubler for frequencies up to 60 Mc. at full rated input. 50% ratings at 150 Mc. Also useful as crystal oscillator with external capacity connected between grid and plate. Class-AB audio amplifier with 60 watts output for two tubes (see 6L6 characteristics). If care is taken in placement of parts and if shield is placed around tube and if the input circuits are shielded from the output circuits, no neutralization will be required for r.f. circuits.

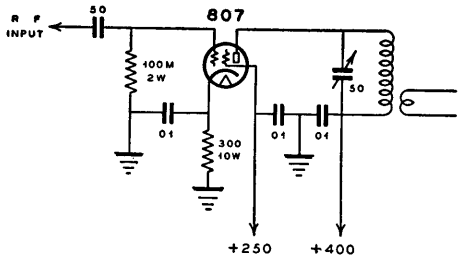

Buffer or doubler circuit.

Characteristics:
Heater Voltage.....6.3 volts
Heater Current.....0.2 amp.
Grid-to-Plate Capacitance.....0.2 μ fd.
Input Capacitance.....11.6 μ fd.
Output Capacitance.....7 μ fd.
Maximum Plate Dissipation.....21 watts
Maximum D.C. Plate Voltage.....600 volts
Plate lead at top of envelope.
Standard 5-pin ceramic base.

R.F. Amplifier:	C.W.	Phone
D.C. Plate Voltage	600	475 volts
D.C. Screen Voltage	250	225 volts
D.C. Grid Voltage	-50	-50 volts
Peak R.F. Grid Voltage	80	80 volts
D.C. Screen Current	95	83 ma.
D.C. Screen Current	10	9 ma.
D.C. Grid Current	3	2.5 ma.
Grid Driving Power (Approx.)	0.22	0.18 watts
Power Output (Approx.)	37	25 watts

RK-39 * RAYTHEON beam power tetrode, designed for frequency doubler, amplifier, or crystal oscillator service. Frequency range: full voltage ratings up to 30 Mc. Maximum plate voltage at 60 Mc., 400 volts.

Characteristics:

Heater Voltage	6.3 volts
Heater Current	0.9 amp.
Grid-to-Plate Capacitance	0.15 μ fd.
Input Capacitance	0.13 μ fd.
Output Capacitance	10.5 μ fd.
Maximum Plate Dissipation	0.21 watts
Maximum Screen Dissipation	3.5 watts
Maximum D.C. Plate Voltage	500 volts
Maximum D.C. Screen Voltage	300 volts
Maximum D.C. Screen Current	20 ma.
Maximum D.C. Plate Current	100 ma.
Maximum D.C. Control Grid Current	5 ma.
Base	Standard 5-Pin Isolantite Plate Through Top of Envelope.

R.F. Service	Class-B	R.F.	Class-C
D.C. Plate Voltage	500	500 volts	
D.C. Plate Current	65	95 ma.	
D.C. Screen Voltage	250	250 volts	
D.C. Screen Current	3	12 ma.	
D.C. Control Grid Current	0.3	3 ma.	
Carrier Power Output	11	35 watts	

RK-41 RAYTHEON beam power pentode, identical with RK-39, except for heater which is 2.5 volts at 2.4 amps.

250 RCA audio amplifier in radio receivers or as a low-power modulator for transmitters. See preceding chapter for a.f. characteristics.

Note: Not over 10,000-ohms resistance can be placed in the grid circuit without endangering tube operation. These tubes have been supplemented by more modern tubes, such as the 2A3 and 6L6.

Characteristics:

Filament Voltage	7.5 volts
Filament Current	1.25 amp.
Grid-to-Plate Capacitance	0.9 μ fd.
Grid-to-Filament Capacitance	0.5 μ fd.
Plate-to-Filament Capacitance	0.3 μ fd.
Maximum Plate Dissipation	0.25 watts
Maximum Plate Voltage	450 volts
Base	Standard 4-pin

WE-254B Tetrode r.f. amplifier. Frequency Range: 100% up to 15 Mc. 66 $\frac{2}{3}$ % at 20 Mc.

Characteristics:

Filament Voltage	7.5 volts
Filament Current	3.25 amps.
Plate-to-Grid Capacitance	0.85 μ fd.
Input Capacitance	11.2 μ fd.
Output Capacitance	5.4 μ fd.
Amplification Factor	100
Maximum Plate Dissipation	0.25 watts
Maximum Screen Dissipation	0.4 watts

Maximum D.C. Plate Voltage	750 volts
Maximum D.C. Plate Current	75 ma.
Maximum D.C. Grid Current	25 ma.
Base	Standard 4-pin, plate through top of envelope.

R.F. Service	Class-B	R.F.	Class-C
D.C. Plate Voltage	750	500	750 volts
D.C. Screen Voltage	150	150	150 volts
D.C. Grid Voltage	-70	-125	-125 volts
D.C. Plate Current	50	75	75 ma.
Approximate Power Output	12.5	25	37.5 watts

RCA-809 * General purpose triode, Class-B modulator, Class-C r.f. amplifier. Frequency range: 100% ratings up to 60 Mc.; 50% ratings at 100 Mc.

Characteristics:

Filament Voltage	6.3 volts (A.C. or D.C.)
Filament Current	2.5 amps.
Amplification Factor	50
Grid-to-Plate Capacitance	6.7 μ fd.
Grid-to-Filament Capacitance	5.7 μ fd.
Plate-to-Filament Capacitance	0.9 μ fd.
Maximum D.C. Plate Dissipation	0.25 watts
Maximum D.C. Plate Current	100 ma.
Maximum D.C. Plate Voltage	750 volts
Maximum D.C. Grid Current	35 ma.
Maximum Plate Power Input	0.75 watts
Base	Standard UX 4-pin, plate through top of bulb

Class-B Audio Service (2 Tubes)	
D.C. Plate Voltage	500 750 volts
D.C. Grid Voltage	0 -5 volts
Peak A.F. Grid-to-Grid Voltage	135 140 volts
Zero Signal D.C. Plate Current	40 35 ma.
Max. Sig. D.C. Plate Current	200 200 ma.
Load Resistance (Plate-to-Plate)	5200 8400 ohms
Max. Sig. Driving Power	2.4 2.4 watts
Max. Sig. Power Output	60 100 watts

R.F. Amplifier Service:	Class-B	Plate-	Class-C
	R.F. Modulated	Telegraphy	
D.C. Plate Voltage	750 600 500	700 volts	
D.C. Grid Voltage	-10 -160 -50	-60 volts	
D.C. Plate Current	50 83 100	100 ma.	
D.C. Grid Current	5 32 20	20 ma.	
Grid Driving Power (Approx.)	1.5 7.2 2.5	2.5 watts	
Grid Bias Loss	0.05 5.1 1.0	1.2 watts	
Power Input	37.5 50 50	70 watts	
Power Output	12.5 38 35	55 watts	

RK-11 RAYTHEON general purpose triode with standard 4-pin base and plate lead through top of bulb. Max. ratings up to 60 Mc.

Characteristics:

Filament Voltage	6.3 volts
Filament Current	3.0 amps.
Amplification Factor	20
Grid-to-Plate Capacitance	0.7 μ fd.
Grid-to-Filament Capacitance	0.7 μ fd.
Plate-to-Filament Capacitance	0.9 μ fd.
Maximum Plate Dissipation	0.25 watts
Maximum D.C. Plate Voltage	750 volts
Maximum D.C. Plate Current	105 ma.
Maximum D.C. Grid Current	35 ma.

Class-C Amplifier Service:	Grid-	Plate-	Telegraphy
	Mod.	Mod.	
D.C. Plate Voltage	750	600	750 volts
D.C. Grid Voltage	-130	-120	-120 volts
D.C. Plate Current	38	85	105 ma.
D.C. Grid Current	1.2	2.4	21 ma.
Driving Power	2.7 (peak)	3.7	3.2 watts
Power Output	12	38	55 watts

RK-12 RAYTHEON zero-bias class-B audio amplifier tube which may also be used for r.f. service such as frequency doubling, 4-pin standard base with plate out through top of glass bulb. Maximum ratings up to 60 Mc. Similar to RK-11 except for mu of 80.

Class-B Audio Amplifier (2 Tubes):

D.C. Plate Voltage750 volts
D.C. Grid Voltage0 volts
Zero Sig. D.C. Plate Current50 ma.
Max. Sig. D.C. Plate Current200 ma.
Max. Sig. D.C. Grid Current65 ma.
Peak A.F. Grid-to-Grid Voltage129 volts
Driving Power3.4 watts
Power Output100 watts

WE-316A U.h.f. oscillator or amplifier especially designed for operation at frequencies above 100 megacycles. The upper limit of oscillation as a regenerative negative grid oscillator is 750 Mc.

Note: Outputs of approximately 8 watts can be obtained at 3/4 meter, and 4 watts at 1/2 meter (600 Mc.).

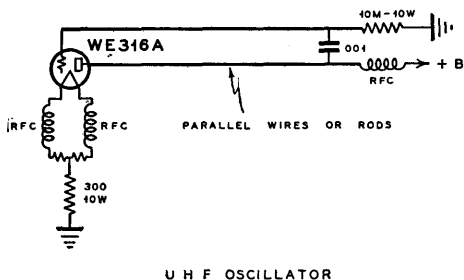

Characteristics:

Filament Voltage2 volts
Filament Current3.65 amps.
Thermionic Emission0.4 amp.
Amplification Factor6.5
Grid-to-Plate Capacitance1.6 μ fd.
Grid-to-Filament Capacitance1.2 μ fd.
Plate-to-Filament Capacitance0.8 μ fd.
Maximum Plate Dissipation30 watts
Maximum D.C. Plate Voltage450 volts
Maximum D.C. Plate Current80 ma.
Maximum D.C. Grid Current10 ma.

All leads extend directly out from tube elements.

800 RCA or AMPEREX triode. Class-B Modulator. Class-C r.f. amplifier. Frequency doubler. U.h.f. oscillator and amplifier. Primarily for replacement; superseded by 834 and 808.

Characteristics:

Filament Voltage7.5 volts
Filament Current3.25 amps.
Amplification Factor15
Maximum Plate Dissipation85 watts
Grid-to-Plate Capacitance2.5 μ fd.
Plate-to-Filament Capacitance2.75 μ fd.
Grid-to-Filament Capacitance1.0 μ fd.
Maximum D.C. Plate Voltage1250 volts
Maximum D.C. Plate Current80 ma.
Maximum D.C. Grid Current25 ma.

Base ..UX 4-pin
Plate and grid at top of envelope.

RK-30 RAYTHEON equivalent of type 800. Characteristics substantially the same except max. plate current rating of 115 ma.

RK-35 RAYTHEON U.h.f. triode. General purpose triode with tantalum plate. Class-B audio r.f. amplifier or oscillator.
Frequency Range: 80% of full ratings at 56 Mc., 60% at 112 Mc.

Note: Grid driving power requirements vary over wide limits, depending upon plate load, circuit losses and type of circuit.

Characteristics:

Filament Voltage7.5 volts
Filament Current3.25 amps.
Amplification Factor8
Grid-to-Plate Capacitance2.7 μ fd.
Grid-to-Filament Capacitance3.5 μ fd.
Plate-to-Filament Capacitance0.4 μ fd.
Maximum Plate Dissipation35 watts
Maximum D.C. Plate Voltage1250 volts
Maximum D.C. Plate Current100 ma.
Maximum D.C. Grid Current20 ma.

Base ..UX 4-pin. Plate at top, grid at side of envelope.

R.F. Service

	Class-B R.F.	Grid-Mod. R.F.	Class-C
D.C. Plate Voltage1000	1000	1000 volts
D.C. Grid Voltage160	240	320 volts
D.C. Plate Current52	50	96 ma.
D.C. Grid Current	15 ma.
Grid Driving Power6	2.6	6.5 watts
Grid Bias Loss	5 watts
Power Input62	50	96 watts
Power Output (Approx.)17	16	70 watts

RK-37 *RAYTHEON high-mu triode, tantalum plate. Oscillator, doubler, or amplifier for very high frequency operation. 100% ratings up to 30 Mc. 80% ratings at 56 Mc. 60% ratings at 112 Mc. Class-B modulator.

Characteristics:

Filament Voltage7.5 volts
Filament Current3.25 amps.
Maximum Plate Dissipation35 watts
Maximum D.C. Plate Voltage1250 volts
Maximum D.C. Plate Current100 ma.
Maximum D.C. Grid Current25 ma.
Grid-to-Plate Capacitance2.9 μ fd.
Grid-to-Filament Capacitance3.2 μ fd.
Plate-to-Filament Capacitance0.3 μ fd.

Standard UX 4-pin base.
Plate through top, grid through side of envelope.

R.F. Service:

	Class-B R.F.	Grid Mod-Telephony	Class-C
D.C. Plate Voltage1000	1000	1000 volts
D.C. Grid Voltage45	—52.5	—70 volts
D.C. Plate Current50	50	95 ma.
D.C. Grid Current	20 ma.
Peak R.F. Grid Power2.3	..	3.0 watts
Peak Audio Voltage	45	.. volts
Carrier Output Power15	15	60 watts

35-T EIMAC high-mu triode. Crystal oscillator for plate voltages up to 1200 volts. Class-B modulator or a.f. amplifier. Class-C buffer or doubler. Class-C telephony. U.h.f. oscillators with quarter-wave line frequency control. U.h.f. r.f. amplifiers.

Frequency Range: 100% ratings up to 100 Mc.
Note (1): For plate modulation, the values of grid bias should be increased at least 50%, and the grid drive will be approximately doubled.

Note (2): Values of grid bias and grid drive may be reduced with regenerative doubler circuits. The above values are for values of efficiencies between 58% and 68%. Lower grid bias and drive give lower efficiencies. With regeneration, the bias may be reduced to approximately 1/2 of the above values without loss of output. The bias should never be less than 3/2 times cutoff bias when doubling.

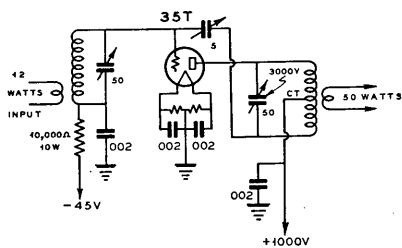

REGENERATIVE FREQUENCY DOUBLER

Characteristics:

Filament Voltage	5 to 5 1/2 volts
Filament Current	4 amps.
Amplification Factor (Average)	30
Maximum Normal Plate Dissipation	35 watts
Grid-to-Plate Capacitance	1.9 μfdfs.
Maximum D.C. Plate Voltage	1500 volts
Maximum D.C. Plate Current	150 ma.
Maximum D.C. Grid Current	25 ma.
Base	UX 4-pin. Plate at top of envelope.

Class-B Audio Amplifier (2 Tubes):

D.C. Plate Voltage	...	500	750	1000	1250	1500	volts
D.C. Grid Voltage	...	0	-10	-22.5	-40	-50	volts
Zero Signal D.C. Plate Current	65	50	40	20	16	ma.
Maximum Signal D.C. Plate Current	200	200	188	158	140	ma.
Load Resistance (Plate to Plate)	...	4000	7000	11000	17200	23600	ohms
Driving Power	6.5	8.5	7.5	5.5	4.5	watts
Output Power	50	90	120	130	140	watts

Class-C R.F. Amplifier Telegraphy (Buffer Service)

D.C. Plate Voltage	400	750	1000	1500	volts
D.C. Grid Voltage	-20	-38	-50	-100	volts
D.C. Plate Current	90	90	90	90	ma.
D.C. Grid Current	15	18	20	20	ma.
Grid Driving Power (Approx.)	2	3.0	3.5	4.5	watts
Grid Bias Loss3	.7	1	2	watts
Power Input	36	67.5	90	135	watts
Power Output (Approx.)	20	47.5	62	101	watts
A.C. Load Resistance	1700	3500	5200	8400	ohms

Frequency Doubler (Without Regeneration):

D.C. Plate Voltage	750	1250	1500	volts
D.C. Grid Voltage	-445	-502	-530	volts
D.C. Plate Current	87	85	87	ma.
D.C. Grid Current	10	10	10	ma.
Grid Driving Power	5	6.5	6.8	watts
Grid Bias Loss	4.5	5	5.3	watts
Power Input	65	106	130	watts
Power Output	37.5	72	90	watts
A.C. Load Resistance	4000	7600	9500	ohms

Regenerative Frequency Doubler:

D.C. Plate Voltage	750	1000	volts
D.C. Grid Voltage	-90	-150	volts
D.C. Plate Current	100	30	ma.
D.C. Grid Current	40	20	ma.
Grid Driving Power	4.5	5.5	watts
Grid Bias Loss	1.3	3	watts
Power Input	75	80	watts
Power Output (Approx.)	40	50	watts

825 TAYLOR 40-watt triode. Intermediate between 801 and 211 tubes. Class-B audio amplifier operating in the class-AB region. Class-B r.f. amplifier for telephony or telegraphy in high-frequency transmitters. Superseded by T-40.

Characteristics:

Filament Voltage	7.5 volts
Filament Current	2 amps.
Amplification Factor	8
Grid-to-Plate Capacitance	7 μfdfs.
Grid-to-Filament Capacitance	3 μfdfs.
Plate-to-Filament Capacitance	2.7 μfdfs.
Maximum Plate Dissipation40 watts
Maximum D.C. Plate Voltage	850 volts
Maximum D.C. Plate Current	110 ma.
Maximum D.C. Grid Current	25 ma.
Base	UX 4-pin

T-40 * TAYLOR h.f. triode. General purpose high-mu tube suitable for frequencies up to 60 Mc. Ceramic 4-pin base with plate through top of bulb. Carbon plate.

Characteristics:

Filament Voltage	7.5 volts
Filament Current	2.5 amps.
Amplification Factor	25
Grid-to-Plate Capacitance	4.5 μfdfs.
Maximum Plate Dissipation40 watts
Maximum D.C. Plate Voltage	1000 volts
Maximum D.C. Plate Current	115 ma.
Maximum D.C. Grid Current	40 ma.

Class-C R. F. Amplifier

D.C. Plate Voltage	1000	volts
D.C. Grid Voltage	-80	volts
D.C. Plate Current	110	ma.
D.C. Grid Current	30	ma.
Driving Power (Approx.)	3.5	watts
Power Output85	watts

TZ-40 * TAYLOR zero-bias triode designed for class-B modulators and frequency doublers. Ceramic 4-pin base with plate through top of bulb.

Characteristics:

Filament Voltage	7.5 volts
Filament Current	2.5 amps.
Amplification Factor	62
Grid-to-Plate Capacitance	4.5 μfdfs.
Maximum Plate Dissipation40 watts
Maximum D.C. Plate Voltage	1000 volts
Maximum D.C. Plate Current	115 ma.
Maximum D.C. Grid Current	35 ma.

Class-B Audio Amplifier (2 Tubes):

D.C. Plate Voltage	1000	volts
D.C. Grid Voltage	0	volts
Zero Sig. D.C. Plate Current44	ma.
Max. Sig. D.C. Plate Current	230	ma.
Load Resistance (Plate-to-Plate)	6800	ohms
Peak A.F. Grid-to-Grid Voltage	220	volts
Power Output	175	watts
Driving Power (Avg.)3	watts

R.F. Service:

See T-40 data.

930 UNITED ELECTRONICS triode. AMPEREX (830). Oscillator, modulator, r.f. amplifier, generally as a neutralized r.f. amplifier or buffer stage in high-frequency transmitters.

Note: Intermediate between 211 and 210 or 801 in operation.

Frequency Range: 100% ratings up to 6 Mc.

Characteristics:

Filament Voltage	10 volts
Filament Current	2 amps.
Amplification Factor8
Grid-to-Plate Capacitance	9.9 μ fds.
Grid-to-Filament Capacitance	4.9 μ fds.
Plate-to-Filament Capacitance	2.2 μ fds.
Maximum Plate Dissipation40 watts
Maximum D.C. Plate Voltage750 volts
Maximum D.C. Plate Current110 ma.
Maximum D.C. Grid Current18 ma.
Base	UX 4-pin

**Class-C
Telephony Telephony Telephony**

R.F. Service:			
D.C. Plate Voltage	750	600	750 max. v.
D.C. Grid Voltage	-95	-180	-180 volts
D.C. Plate Current	80	100	110 ma.
D.C. Grid Current	15	15 ma.
Grid Driving Power	5	5 watts
Grid Bias Loss	2.7	2.7 watts
Power Input	60	60	82.5 watts
Power Output	20	40	55 watts

WE-300A

WESTERN ELEC-
TRIC class-A audio
amplifier or modu-
lator, especially suitable for automobile transmitters.

Note: If fixed C bias is used, the plate current should be limited to not over 70 ma.

Characteristics:

Filament Voltage	5.0 volts A.C. or D.C.
Filament Current	1.2 amp.
Amplification Factor (Approx.)	3.8
Grid-to-Plate Capacitance	15 μ fds.
Grid-to-Filament Capacitance9 μ fds.
Plate-to-Filament Capacitance	4.3 μ fds.
Maximum Plate Dissipation40 watts
Maximum D.C. Plate Voltage450 volts
Maximum D.C. Plate Current100 ma.

Class-A (Single Tube) Modulator:

D.C. Plate Voltage	200	250	350	450 volts
D.C. Grid Voltage	-39	-45	-71	-97 volts
D.C. Plate Current	40	80	80	80 ma.
Load Resistance	2500	1500	2200	3000 ohms
Power Output	2.6	5.0	9.6	14.6 watts

Push-Pull Operation (2 Tubes)

D.C. Plate Voltage	450 volts
D.C. Plate Current (Per Tube)70 ma.
Mutual Conductance	5200 ohms
Class-A Power Output25 watts

RK-18

RAYTHEON h.f. triode, class-B modulator. Class-C r.f. amplifier or oscillator. Buffer or doubler. Superseded by newer Raytheon types.

Characteristics:

Filament Voltage	7.5 volts
Filament Current	3.0 amps.
Amplification Factor18
Grid-to-Plate Capacitance	4.8 μ fds.
Grid-to-Filament Capacitance	4.6 μ fds.
Plate-to-Filament Capacitance	2.9 μ fds.
Maximum Plate Dissipation40 watts
Maximum D.C. Plate Voltage1000 volts
Maximum D.C. Plate Current85 ma.
Maximum D.C. Grid Current25 ma.
Base	UX 4-pin. Plate at top of envelope.

RK-31

RAYTHEON high mu triode. Primarily a class-B audio amplifier. May be used for r.f.

Note: R.f. grid excitation requirements vary widely; thus the driver stage should be designed with ample factor of safety for output needs.

Characteristics:

Filament Voltage	7.5 volts
Filament Current	3.0 amps.

Amplification Factor Varies with Inputhigh mu.
Maximum Plate Dissipation40 watts
Maximum D.C. Plate Voltage1250 volts
Maximum D.C. Plate Current85 ma.
BasePlate at top of envelope UX 4-pin.

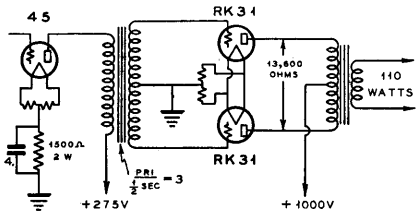

CLASS B AUDIO AMPLIFIER OR MODULATOR

Class-B Modulator or A.F. Amplifier:

D.C. Plate Voltage	1000	1250 volts (max.)
D.C. Grid Voltage	0	0 volts
Grid Driving Power (2 Tubes)	900	900 milliwatts
Zero Signal D.C. Plate Current (Per Tube)	12	15 ma.
Maximum Signal D.C. Plate Current (Per Tube)	80	80 ma.
Load Resistance (Plate to Plate)	13,600	17000 ohms
Power Output (2 Tubes)	110	140 watts

R.F. Service

	Class-C Telephony	Frequency Doubler
D.C. Plate Voltage	1250	1000 volts
D.C. Grid Voltage	-90	-300 volts
D.C. Plate Current	88	85 ma.
D.C. Grid Current	25	15 ma.
Grid Driving Power	5.25	6 watts
Grid Bias Loss	2.25	4.5 watts
Power Input	106	85 watts
Approximate Power Output	76	52 watts
Approximate A.C. Load Impedance	7250	5400 ohms

756

TAYLOR triode for doubler and class-C operation. Class-B audio amplifier. Somewhat superseded by T-40.

Note: Grid drive requirements vary widely under different operating conditions.

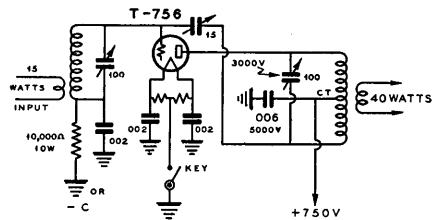

R F DOUBLER OR NEUTRALIZED BUFFER

Characteristics:

Filament Voltage	7.5 volts
Filament Current	2 amps.
Amplification Factor25
Grid-to-Plate Capacitance8 μ fds.
Grid-to-Filament Capacitance	3.5 μ fds.
Plate-to-Filament Capacitance	2.7 μ fds.
Maximum D.C. Plate Voltage850 volts
Maximum D.C. Plate Current110 ma.
Maximum D.C. Grid Current20 ma.
Base	UX 4-pin Isolantite

Class-B Audio Amplifier (2 Tubes):

D.C. Plate Voltage	850 volts
D.C. Grid Voltage	-30 volts
Zero Signal Plate Current	200 ma.
Maximum Signal Plate Current	225 ma.
Load Impedance (Plate-to-Plate)	6750 ohms
Power Output	100 watts

Class-C R.F. Amplifier:

	Plate-Mod. Telephony	Telegraphy
D.C. Plate Voltage	750	850 volts
D.C. Grid Voltage	-80	-75 -85 volts
D.C. Plate Current	90	110 ma.
D.C. Grid Current	20	16 16 ma.
Grid Driving Power (Approx.)	5	3.5 3.7 watts
Grid Bias Loss	1.6	1.2 1.4 watts
Power Input	67.5	82.5 93.5 watts
Power Output	40	50 60 watts

804 RCA pentode r.f. amplifier. Frequency doubler. Oscillator. Suppressor, grid or plate-modulated amplifier.

Caution: Do not apply screen voltage without simultaneous application of plate voltage.
Frequency Range: 100% ratings at 15 Mc. 75% at 35 Mc. and 50% at 80 Mc. Special attention should be given to shielding and by-passing at high frequencies.

Characteristics:

Filament Voltage	7.5 volts
Filament Current	3.0 amps.
Grid-to-Plate Capacitance	0.1 μ fd.
Input Capacitance	16 μ fd.
Output Capacitance	14.5 μ fd.
Maximum Plate Dissipation	40 watts
Maximum Screen Dissipation	15 watts
Mutual Conductance	3250 micromhos
Base UX 5-pin.	Plate at top of envelope

R.F. Service:

	Class-B Telephony	Suppressor-Mod. Telephony	Pentode Class-C Telegraphy	Tetrode Class-C Telegraphy
D.C. Plate Voltage	1250	1000	1250	1250 volts
D.C. Screen Voltage	300	300	300	180 volts
D.C. Suppressor Voltage	45	-35	-50	45 180 volts
D.C. Grid Bias	-20	-100	-100	-100 volts
Peak R.F. Grid Volts	27	140	140	150 160 volts
Peak A.F. Grid Volts	..	60	70 volts
D.C. Plate Current	45	45	48	92 92 ma.
D.C. Screen Current	11	83.5	35.5	27 23 ma.
D.C. Grid Current	1	5.5	7	8 ma.
Grid Driving Power	.25	.7	.85	.9 1.2 watts

Grid Bias Loss	..	.6	.7	.7	.8 watt
Power Output (Approx.)	16	16	21	80	80 watts
Screen Resistor	..86,000	21,000	27,000	35,000	.. ohms

RK-20 RAYTHEON r.f. amplifier. Frequency doubler. Oscillator. Suppressor, Grid- or Plate-modulated amplifier.

Caution: Do not apply screen voltage without simultaneous application of plate voltage.
Frequency Range: 100% ratings up to 20 Mc.

Characteristics:

Filament Voltage	7.5 volts
Filament Current	3.0 amps.
Grid-to-Plate Capacitance	0.12 μ fd.
Input Capacitance	11 μ fd.
Output Capacitance	10 μ fd.
Maximum Plate Dissipation	40 watts
Maximum Screen Dissipation	15 watts
Base	UX 5-pin. Isolantite. Plate at top of envelope.

R.F. Service:

	Class-B Telephony	Suppressor Modulation	Class-C Telegraphy
D.C. Plate Voltage	1250	1250	1250 volts
D.C. Screen Voltage	300	300	300 volts
D.C. Suppressor Voltage	0	-45	0 -45 volts
D.C. Grid Bias	-30	-100	-100 volts
Peak R.F. Grid Volts	70	175	175 volts
Peak A.F. Grid Volts	..	75 volts
D.C. Plate Current	43	43	80 92 ma.
D.C. Screen Current	15	36	37 32 ma.
D.C. Grid Current	..	5	5 5 ma.
Grid Driving Power	.5	.9	.9 .9 watt
Grid Bias Loss	..	.5	.5 .5 watt
Power Output (Approx.)	16	18	64 80 watts
Screen Resistor	..60,000	25,000	26,000 29,000 ohms

RK-46 RAYTHEON pentode, similar to RK-20, except for filament and envelope, which are heavier in construction. Filament is rated at 12.6 volts at 2.5 amps. Designed for mobile and aircraft transmitters.

RCA-814 *Beam power tetrode with high power gain characteristic. Used as r.f. amplifier, frequency doubler, oscillator and plate-modulated amplifier. 100% ratings up to 30 Mc. 50% ratings at 100 Mc.

Characteristics:

Filament Voltage	..10 volts
Filament Current	..3.25 amps.
Grid-to-Plate Capacitance	..0.1 μ fd.
Input Capacitance	..13.5 μ fd.
Output Capacitance	..13.5 μ fd.
Max. D.C. Plate Voltage	..1250 volts
Max. D.C. Screen Voltage	..300 volts
Maximum Plate Dissipation	..50 watts
Maximum Plate Input	..180 watts
Maximum Screen Dissipation	..10 watts
Max. D.C. Grid Current	..10 ma.
Max. D.C. Plate Current	..150 ma.
Base	..Std. 5-pin ceramic. Plate through top of bulb.

R.F. Amplifier Service:

	Class-B	Grid-Mod. Grid-Class-C	Class-C Plate-Mod. Class-C	Class-C Teleg.
D.C. Plate Voltage	1250	1250	1000 max.	1250 volts
D.C. Screen Voltage	200	200	300	300 volts

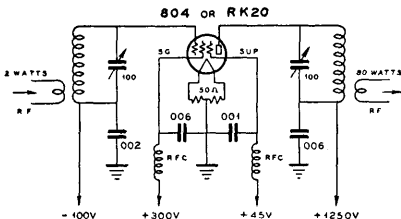

Conventional screen-grid buffer or final amplifier.

D.C. Grid Voltage	—23	—100	—150	—80 volts
D.C. Plate Current	60	60	120	144 ma.
D.C. Screen Current	1	1.4	17.5	22.5 ma.
D.C. Grid Current	1.8	2.8	10	10 ma.
Screen Resistor			40,000	42,000 ohms
Driving Power (Approx.)	0.65	2.3	2	1.5 watts
Power Output	25	29	87	180 watts

RK-47* RAYTHEON equivalent of RCA 814 beam power tetrode, designed for r.f. amplifier-doubler service. Somewhat similar to RK-20, except for special grid structure; slightly higher plate efficiency than in similar types of pentode tubes.

Characteristics:

Filament Voltage	10 volts
Filament Current	3.25 amps.
Maximum D.C. Plate Voltage	1250 volts
Maximum D.C. Screen Voltage	300 volts
Maximum Plate Dissipation	.50 watts
Maximum Screen Dissipation	.15 watts
Maximum D.C. Grid Current	.10 ma.
Grid-to-Plate Capacitance	0.12 $\mu\text{fd.}$
Input Capacitance	.13 $\mu\text{fd.}$
Output Capacitance	.10 $\mu\text{fd.}$
Base	Standard UX 5-pin.

Plate through top of envelope.

841A TAYLOR h.f. triode. Doubler or buffer stage in high-power transmitters. R.F. amplifier down to 7½ meters. Somewhat superseded by T-55.
Note: Grid driving power requirements vary over wide limits under operating conditions.

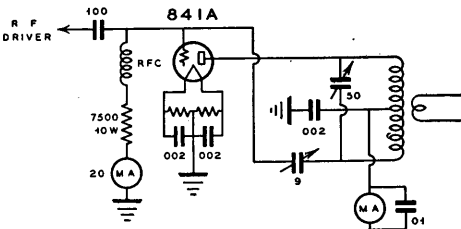

Neutralized buffer.

Characteristics:

Filament Voltage	10 volts
Filament Current	2 amps.
Amplification Factor	14.6
Grid-to-Plate Capacitance	.9 $\mu\text{fd.}$
Grid-to-Filament Capacitance	3.5 $\mu\text{fd.}$
Plate-to-Filament Capacitance	2.5 $\mu\text{fd.}$
Maximum Plate Dissipation	.50 watts
Maximum D.C. Plate Voltage	1250 volts
Maximum D.C. Plate Current	.150 ma.
Maximum D.C. Grid Current	.80 ma.
Base	Standard UX 4-pin

Class-C R.F. Amplifier:

D.C. Plate Voltage	1000 volts
D.C. Grid Voltage	—180 volts
D.C. Plate Current	.150 ma.
D.C. Grid Current	.20 ma.
Grid Driving Power	.7 watts

Grid Bias Loss	3.6 watts
Power Input	150 watts
Power Output	100 watts

304B* WESTERN ELECTRIC u.h.f. oscillator or amplifier up to 300 Mc. Similar to RCA 834.

Frequency	Class-C Telegraphy Plate Volts	Oscillator Plate Volts
100 Mc.	1250	1000
200 Mc.	1000	800
300 Mc.	750	600

Characteristics:

Filament Voltage	7.5 volts
Filament Current	3.25 amps.
Amplification Factor	.11
Grid-to-Plate Capacitance	2.5 $\mu\text{fd.}$
Grid-to-Filament Capacitance	2.0 $\mu\text{fd.}$
Plate-to-Filament Capacitance	0.7 $\mu\text{fd.}$
Maximum Plate Dissipation	.50 watts
Maximum D.C. Plate Voltage	1250 volts
Maximum D.C. Plate Current	100 ma.
Maximum D.C. Grid Current	.25 ma.
Base	Standard UX 4-pin

Plate and Grid at Top of Envelope.

Class-B Audio Amplifier (2 Tubes):

D.C. Plate Voltage	750	1000	1250 volts
D.C. Grid Voltage	—55	—85	—110 volts
Max. Sig. D.C. Plate Cur.	200	200	200 ma.
Zero Sig. D.C. Plate Cur.	40	40	40 ma.
Load Res. (Plate-to-Plate)	7000	10,000	14,000 ohms
Power Output	85	110	140 watts
Driver Power	10	10	10 watts

Class-C Service

See 834.

808* RCA tantalum plate triode. High-frequency oscillator and amplifier. 100% ratings up to 30 Mc. 50% ratings at 130 Mc.

Characteristics:

Filament Voltage	7.5 volts
Filament Current	4 amps.
Amplification Factor	.47
Grid-to-Plate Capacitance	2.9 $\mu\text{fd.}$
Grid-to-Filament Capacitance	5.8 $\mu\text{fd.}$
Plate-to-Filament Capacitance	0.15 $\mu\text{fd.}$
Base	Standard UX 4-pin base.

Plate through top, grid through side of envelope.

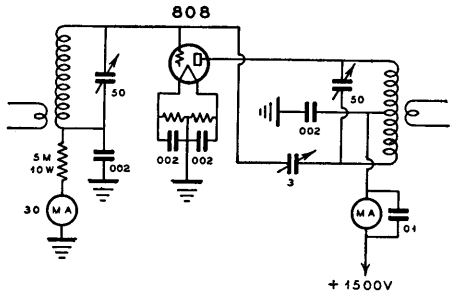

Neutralized buffer or c. w. amplifier.

Class-B Audio Amplifier (2 Tubes):

D.C. Plate Voltage	1250	1500 volts
D.C. Grid Voltage	—15	—25 volts
Zero Signal D.C. Plate Current	40	30 ma.
Maximum Signal D.C. Plate Current	230	190 ma.
Load Resistance (Plate-to-Plate)	12700	18300 ohms

Grid Driving Power	7.8	4.8 watts
Power Output, Approximate	190	185 watts

Class-C R.F. Amplifier:

	Plate-Mod. Telephony		Class-C Telegraphy	
	D.C. Plate Voltage	1250	1250	1500
D.C. Grid Voltage	-225	-150	-200	volts
D.C. Plate Current	100	135	125	ma.
D.C. Grid Current	32	30	30	ma.
Grid Driving Power	10.5	8	9.5	watts
Grid Bias Loss	7	4.5	6	watts
Power Output (Approximate)	105	120	140	watts

HK-54 * HEINTZ & KAUFMAN general purpose high-mu triode for high-frequency service. Tantalum plate and grid. Standard 4-pin base, plate through top and grid through side of glass envelope.

Characteristics:

Filament Voltage	5.0	volts
Filament Current	5.0	amps.
Amplification Factor	27	
Grid-to-Plate Capacitance	1.9	μfd.
Grid-to-Filament Capacitance	1.9	μfd.
Plate-to-Filament Capacitance	0.3	μfd.
Normal Plate Dissipation	.50	watts
Max. D.C. Plate Voltage	2000	volts
Max. D.C. Plate Current	.150	ma.
Max. D.C. Grid Current	.30	ma.

Class-B Audio Amplifier (2 Tubes):

D.C. Grid Voltage	-15	-25	-45	volts
D.C. Grid Voltage	-15	-25	-45	volts
Zero Sig. D.C. Plate Current	40	40	40	ma.
Max. Sig. D.C. Plate Current	226	233	200	ma.
Load Resistance (Plate-to-Plate)	6000	8500	16800	ohms
Power Output	95	140	200	watts

Class-C R.F. Amplifier:

D.C. Plate Voltage	750	1250	2000	volts
D.C. Grid Voltage	-90	-140	-270	volts
D.C. Plate Current	135	135	130	ma.
D.C. Grid Current	20	20	20	ma.
Driving Power (Approx.)	5	6.5	9	watts
Power Output	70	125	210	watts
Effective R.F. Grid Voltage	185	223	330	volts

HK-154 HEINTZ & KAUFMAN. General purpose u.h.f. and h.f. triode tantalum plate and grid.

Note: Grid drive requirements vary widely under different operating conditions.

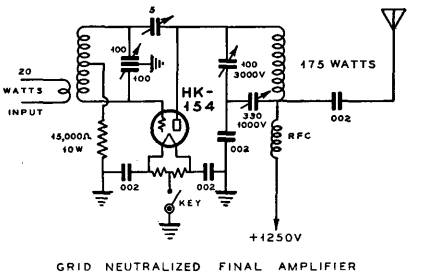

Characteristics:

Filament Voltage	5.0	volts
Filament Current	6.5	amps.
Amplification Factor	6.7	
Grid-to-Plate Capacitance	.5	μfd.
Maximum Plate Dissipation	.50	watts
Maximum D.C. Plate Voltage	1500	volts

Maximum D.C. Plate Current	175	ma.
Maximum D.C. Grid Current	30	ma.
Base	UX	4-pin
Grid and Plate Leads Through Opposite Sides of Envelope.		

A.F. Amplifier (2 Tubes):

D.C. Plate Voltage	750	1000	1500	volts
Power Output	150	200	250	watts
Grid Driving Power (Approx.)	10	10	10	watts

R.F. Service:

	Class-B R.F.		Class-C R.F.	
	D.C. Plate Voltage	750	1500	750
D.C. Plate Current	80	56	175	175
D.C. Grid Voltage	-112	-225	-275	-350
D.C. Grid Current	20	20	20	20
Approx. Grid Driving Power	6	10	13	13
Grid Bias Loss	5.5	7	10	10
Approx. Pow. Output	18	28	85	125

834 RCA u.h.f. amplifier and oscillator. Frequency Range: Up to 350 megacycles.

Rated input at 100 Mc.—100%
Rated input at 350 Mc.—50%

Note (1): Grid driving power varies with type of circuit used, load impedance, and frequency range (dielectric and circuit losses increase with frequency). Driver should be capable of twice as much output as listed for grid drive and bias loss as a factor of safety in design.

(2): Regeneration in the frequency doubler will allow lower values of grid bias and grid drive for same output power.

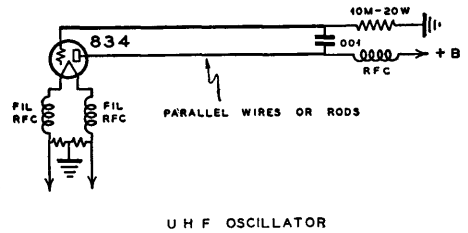

Characteristics:

Filament Voltage	7.5	volts
Filament Current	3.25	amps.
Amplification Factor	10.5	
Grid-to-Plate Capacitance	2.6	μfd.
Grid-to-Filament Capacitance	2.2	μfd.
Plate-to-Filament Capacitance	0.6	μfd.
Maximum Plate Dissipation	.50	watts
Maximum D.C. Plate Voltage	1250	volts
Maximum D.C. Plate Current	100	ma.
Maximum D.C. Grid Current	20	ma.
Base	UX	4-pin
Plate and Grid Through Top of Tube Envelope.		

R.F. Amplifier:

	Class-C Telegraphy		Class-C Telephony	Class-B Telephony
	Amplifier	Doublers		
D.C. Plate Voltage	1250	1000	1000	1000
D.C. Plate Current	95	78	90	50
D.C. Grid Current	15	10	17.5	0.5
D.C. Grid Voltage	-193	-684	-310	-80
Grid Driving Power	4.8	8.4	7.5	3
Grid Bias Loss	2.9	6.8	5.5	.6
Power Input	119	78	90	50
Approx. Power Output	89	45	60	16
Approx. A.C. Load Imped.	6500	6600	5500	...
Max. D.C. Load Imped.	11,100	...

RK-32 RAYTHEON U.h.f. triode. Substantially similar to 834 in all respects. See 834 data.

T-55 * TAYLOR class-C r.f. amplifier. U.h.f. oscillator down to 2 meters wavelength.

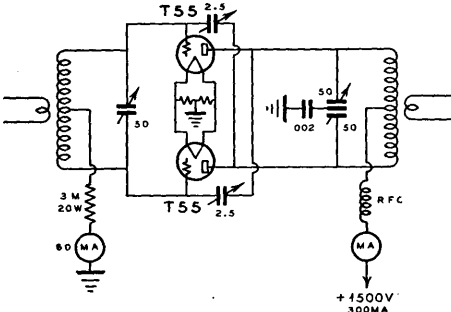

Push-pull r.f. amplifier.

Characteristics:
 Filament Voltage 7.5 volts
 Filament Current 2.75 amps.
 Amplification Factor 20
 Grid-to-Plate Capacitance 3.75 μ fds.
 Grid-to-Filament Capacitance 4.0 μ fds.
 Plate-to-Filament Capacitance 1.5 μ fds.
 Maximum Plate Dissipation55 watts
 Maximum D.C. Plate Voltage 1500 volts
 Maximum D.C. Plate Current 150 ma.
 Maximum D.C. Grid Current40 ma.
 Base UX 4-pin
 Plate at Top of Envelope.

Class-C R.F. Amplifier:
 D.C. Plate Voltage 1500 volts
 D.C. Grid Voltage -180 volts
 D.C. Plate Current 150 ma.
 D.C. Grid Current30 ma.
 Grid Driving Power10 watts
 Grid Bias Loss55 watts
 Power Input 225 watts
 Power Output 170 watts

Class-B Audio Amplifier (2 Tubes):
 D.C. Plate Voltage 1000 volts 1500 volts
 D.C. Grid Voltage (Approx.) .. -45 volts. -67.5 volts
 Zero Sig. D.C. Plate Current .. 40 ma. 40 ma.
 Load Resistance, Plate-to-Plate, 10,000 ohms 12,000 ohms
 Audio Output (2 Tubes) 125 watts 175 watts

RK-51 RAYTHEON general purpose triode with 4-pin standard base and plate through top of bulb. Maximum ratings up to 60 Mc.

Characteristics:
 Filament Voltage 7.5 volts
 Filament Current 3.75 amps.
 Amplification Factor 20
 Grid-to-Plate Capacitance6 μ fds.
 Grid-to-Filament Capacitance8 μ fds.
 Plate-to-Filament Capacitance 2.5 μ fds.
 Max. Plate Dissipation60 watts
 Max. D.C. Plate Voltage 1500 volts
 Max. D.C. Plate Current 150 ma.
 Max. D.C. Grid Current40 ma.

Class-C R.F. Amplifier:

	Grid. Mod.	Plate Mod.	Telegraphy
D.C. Plate Voltage	1500	1250	1500 volts
D.C. Grid Voltage	-130	-200	-250 volts
D.C. Plate Current	60	105	150 ma.
D.C. Grid Current	0.4	17	31 ma.
Driving Power	2.3(Peak)	4.5	10 watts
Power Output	32	96	170 watts

RK-52 RAYTHEON zero-bias modulator tube with standard 4-pin base and plate through top of bulb. May be used as a frequency doubler. Maximum ratings up to 60 Mc.

Characteristics:
 Filament Voltage 7.5 volts
 Filament Current 3.75 amps.
 Amplification Factor (Approx.) 150
 Grid-to-Plate Capacitance12 μ fds.
 Grid-to-Filament Capacitance 6.6 μ fds.
 Plate-to-Filament Capacitance 2.3 μ fds.
 Maximum Plate Dissipation62.5 watts
 Maximum D.C. Plate Voltage 1250 volts
 Maximum D.C. Plate Current 150 ma.
 Maximum D.C. Grid Current50 ma.

Class-B Audio Amplifier (2 Tubes):

D.C. Plate Voltage 1250 volts
 D.C. Grid Voltage0 volts
 Zero Sig. D.C. Plate Current 40 ma.
 Maximum Sig. D.C. Plate Current 300 ma.
 Maximum Sig. D.C. Grid Current100 ma.
 Peak A.F. Grid-to-Grid Voltage180 volts
 Driving Power 7.5 watts
 Load Resistance (Plate-to-Plate) 10,000 ohms
 Power Output 250 watts

203-B TAYLOR high-mu triode. Redesigned primarily for class-B audio amplifiers. Somewhat superseded by 203-Z.

Characteristics:
 Filament Voltage 10 volts
 Filament Current 3.85 amps.
 Amplification Factor25
 Maximum Plate Dissipation55 watts
 Maximum D.C. Plate Voltage 1250 volts
 Maximum D.C. Plate Current, 150 ma. (in R.F. circuits) 150 ma.
 Grid-to-Plate Capacitance14 μ fds.
 Grid-to-Filament Capacitance6 μ fds.
 Plate-to-Filament Capacitance5 μ fds.
 Base Standard 4-pin, 50-watt

830B RCA 830-B. AMPEREX 830-B. UNITED ELECTRONICS 930-B. Class-B modulator for outputs up to 175 watts. May be driven by a push-pull 45 or 2A3 driver stage. Also used for r.f.

R.F. Frequency range: 100% ratings up to 15 Mc. 75% at 30 Mc. 50% at 60 Mc.

Note: R.f. grid driving power requirements vary with load impedance, circuit design and circuit losses with increases of frequency. The driver stage should be capable of supplying twice as much power output as listed for grid drive and grid bias loss.

Characteristics:
 Filament Voltage 10 volts
 Filament Current 2 amps.
 Amplification Factor25
 Maximum Plate Dissipation60 watts
 Grid-to-Plate Capacitance11 μ fds.
 Grid-to-Filament Capacitance5 μ fds.
 Plate Filament Capacitance 1.8 μ fds.
 Max. D.C. Plate Voltage 1000 volts
 Maximum D.C. Grid Current60 ma.
 Maximum D.C. Plate Current 150 ma.
 Base UX 4-pin
 Plate at top of envelope.

Class-B Modulator or A.F. Amplifier:

D.C. Plate Voltage	800	1000 volts
D.C. Grid Voltage	-27	-35 volts
Peak Grid-to-Grid A.F. Volts	250	270 volts
Zero Sig. D.C. Plate Current (2 Tubes)	20	20 ma.
Maximum Sig. D.C. Plate Current (2 Tubes)	280	280 ma.
Eff. Load Resistance (Plate-to-Plate) 600		7600 ohms
Grid Driving Power	5	6 watts
Maximum Sig. Power Output	110	150 watts

203-Z TAYLOR zero-bias audio amplifier. Designed for class-B audio amplifiers or modulators with zero grid bias. Can be operated as r.f. amplifier below 15 Mc.

Characteristics:

Filament Voltage	10 volts
Filament Current	3.85 amps.
Mutual Conductance	5900 μ ms.
Amplification Factor85
Maximum D.C. Plate Voltage.....	1250 volts
Maximum Plate Dissipation65 watts
Base	Standard 4-pin 50-watt Plate through top of envelope.

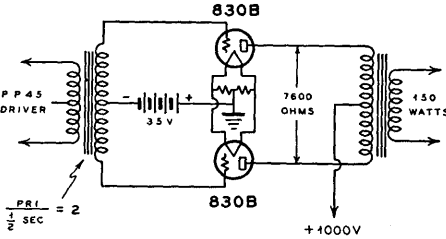

Class-B Modulator (2 Tubes):

D.C. Plate Voltage.....	900	1000	1100	1250	volts
D.C. Grid Bias	zero	zero	zero	zero	volts
Zero Signal D.C. Plate Current (Per Tube)	30	35	40	45	ma.
Max. Signal D.C. Plate Current (2 Tubes).....	350	300	350	350	ma.
Load Impedance, Plate-to- Plate	5400	6900	6700	7900	ohms
Audio Power Output.....	200	200	260	300	watts
Approx. Grid Driving Power	7	7	7	7	watts

R.F. Service:

	Class- B R.F.	Class- C Tel- ephony	Class-C Telegraphy	Class-C Doubling	Frequency Doubling
D.C. Plate Voltage ..	1000	800	600	1000	1000 volts
D.C. Plate Current ..	85	95	140	140	75 ma.
D.C. Grid Bias	-35	-150	-95	-110	-435 volts
D.C. Grid Current ..	6	20	30	30	15 ma.
Grid Driving Power (Approx.)	6*	5	6	7	8.5 watts
Grid Bias Loss	2	3	2.8	3.3	6.5 watts
Power Input	85	76	84	140	75 watts
Power Output (Approx.)	26	50	45	90	45 watts
Mod. D.C. Load Resist.. Approximate A.C. Load Impedance	8400	4200	2150	3600	... ohms

*At Peak.

WE-282A WESTERN ELECTRIC tetrode. Screen-grid r.f. amplifier or frequency doubler.

Frequency Range: 100% ratings up to 30 Mc. 50% ratings at 60 Mc.

Characteristics:

Filament Voltage	10 volts
Filament Current	3 amps.
Amplification Factor	100
Plate-to-Grid Capacitance.....	0.2 μ fd.
Input Capacitance	12.2 μ fds.
Output Capacitance	6.8 μ fds.
Maximum Plate Dissipation70 watts
Maximum D.C. Plate Voltage.....	1000 volts
Maximum D.C. Plate Current	100 ma.
Maximum D.C. Grid Current	50 ma.
Maximum Screen Grid Dissipation5 watts
Base	Standard 4-pin 50-watt

R.F. Service

	Class-B R.F.	Class-C Telegraphy	
D.C. Plate Voltage	1000	750	1000 volts
D.C. Grid Voltage	-80	-150	-150 volts
D.C. Screen Grid Voltage	150	150	150 volts
D.C. Plate Current	100	100	100 ma.
Plate Power Input	100	75	100 watts
Approximate Power Output.....	33	50	67 watts

WE-305A WESTERN ELECTRIC r.f. amplifier, oscillator or harmonic generator at ultra-high frequencies.

Frequency Range: 100% ratings up to 50 Mc. 50% plate voltage rating at 100 Mc.

Note: Plate, screen, and filament center-tap leads come out through rods at top of tube to enable short leads at very high frequencies. Cooling lugs of copper are needed for operation at frequencies above 50 Mc.

Characteristics:

Filament Voltage	10 volts
Filament Current	3.1 amps.
Plate-to-Grid Capacitance	0.14 μ fd.
Input Capacitance	10.5 μ fds.
Output Capacitance	5.4 μ fds.
Maximum Plate Dissipation60 watts
Maximum Screen Dissipation6 watts
Maximum D.C. Plate Voltage.....	1000 volts
Maximum D.C. Screen Voltage.....	200 volts
Maximum D.C. Plate Current.....	125 ma.
Maximum D.C. Grid Current.....	40 ma.

R.F. Service

	Class-B R.F.	Class-C R.F.	
D.C. Plate Voltage	1000	1000	750 volts
D.C. Grid Voltage	-135	-250	-175 volts
D.C. Screen Voltage.....	200	200	200 volts
D.C. Plate Current.....	90	125	125 ma.
Approx. Power Output....	30	85	65 49 watts

HF-100 AMPEREX triode. H.f. and u.h.f. frequency doubler, amplifier or oscillator down to 2 meters in wavelength. Class-B modulator, though superseded by ZB120 for this purpose.

Characteristics:

Filament Voltage	10 to 10.5 volts
Filament Current	2 amps.
Amplification Factor	23
Grid-to-Plate Capacitance	4.5 μ fds.
Grid-to-Filament Capacitance	3.5 μ fds.
Plate-to-Filament Capacitance	1.4 μ fds.
Maximum Plate Dissipation75 watts
Maximum D.C. Plate Voltage.....	1500 volts
Maximum D.C. Plate Current	150 ma.
Maximum D.C. Grid Current	30 ma.
Base	UX 4-pin
Plate Out Top, Grid Out Side of Envelope. Carbon plate	

Class-C R.F. Service:	30 Mc. or Lower	120 Mc.
D.C. Plate Voltage	1500	1000 volts
D.C. Grid Voltage	-200	-110 volts
D.C. Plate Current	150	120 ma.
D.C. Grid Current	20	20 ma.
Grid Drive (Approx.)	7	6 watts
Grid Bias Loss	4	2.2 watts
Power Output (Approx.)	170	70 watts
Maximum Plate Dissipation	75	50 watts

ZB120* AMPEREX. Zero bias triode. Especially designed for class-B audio amplification. Can be used as linear r.f. power amplifier. Is capable of delivering up to 150 watts in class-C r.f. service. Its high amplification factor makes it an efficient frequency doubler.

Characteristics:

Filament Voltage10 volts
Filament Current2 amps.
Amplification Factor90
Maximum Plate Dissipation74 watts
Maximum D.C. Plate Voltage1250 volts
Maximum A.F. Power Output (2 Tubes)300 watts
Transconductance at 100 ma. Plate Current5000 μ hos
BaseStandard 50-watt. Plate: Carbon

WE-242A WESTERN ELECTRIC triode. R.f. amplifier or oscillator. Audio amplifier in modulators.

Frequency Range: 100% up to 6 Mc. 50% of plate voltage ratings at 30 Mc.

Characteristics:

Filament Voltage10 volts
Filament Current3.25 amps.
Amplification Factor12.5
Grid-to-Plate Capacitance13.0 μ fd.
Grid-to-Filament Capacitance6.5 μ fd.
Plate-to-Filament Capacitance4.0 μ fd.
Maximum Plate Dissipation85 watts
Maximum D.C. Plate Voltage1250 volts
Maximum D.C. Plate Current150 ma.
Maximum D.C. Grid Current50 ma.
Base4-pin, 50-watt

Class-B Audio Amplifier (2 Tubes):

D.C. Plate Voltage1000	1250 volts
D.C. Grid Voltage-55	-80 volts
Maximum Signal D.C. Plate Current300	300 ma.
Zero Signal D.C. Plate Current60	60 ma.
Load Resistance (Plate-to-Plate)6000	8000 ohms.
Power Output165	200 watts
Driver Power25	25 watts

R.F. Service

	Class-B	Class-C	
	R.F. Telephony	Telephony	
D.C. Plate Voltage1250	1000	1250 volts (max.)
D.C. Grid Voltage-90	-175	-200 volts
D.C. Plate Current106	150	150 ma.
D.C. Grid Current	30	30 ma.
Grid Driving Power	10	11 watts
Grid Bias Loss	5	6 watts
Power Input132.5	150	187.5 watts
Power Output44	100	125 watts

810* RCA power amplifier triode. May be used as a class-C amplifier (telephony or telephony) or as a class-C or class-B grid-modulated r.f. amplifier. May be operated at 100% ratings in all classes of service as high as 30 Mc.

Tentative Characteristics:

Filament Voltage10 volts
Filament Current4.5 amps.
Amplification Factor (Approx.)35
Grid-to-Plate Capacitance4.8 μ fd.
Grid-to-Filament Capacitance9.2 μ fd.

Plate-to-Filament Capacitance12.9 μ fd.
Plate Top CapMedium Metal
Grid Side CapMedium Metal
BaseJumbo 4-Large Pin, Bayonet
Socket ConnectionsSame as RCA-806

R.F. Power Amplifier—Class-C Service:

	Telephony	Telegraphy
D.C. Plate Voltage (Max.)1600	2000 volts
D.C. Grid Voltage (Max.)-500	-600 volts
D.C. Plate Current (Max.)210	250 ma.
D.C. Grid Current (Max.)70	70 ma.
Plate Input (Max.)335	500 watts
Plate Dissipation (Max.)85	125 watts

211 Class-B modulator. Class-B and -C r.f. amplifier for telephony or telegraphy. Occasionally used as a frequency doubler.

Frequency Range: Full ratings up to 6 megacycles. 50% ratings at 30 Mc.

Note (1): Grid driving requirements vary with load impedance, frequency of operation (due to losses), and type of circuit; thus, the driver stage should be capable of supplying twice as much power output as listed for grid drive and bias loss.

Note (2): The WE 242A is similar in characteristics and operation to the 211. The 211D (do not confuse with old WE-211D) is similar to the 211 but it also has slightly lower interelectrode capacitances.

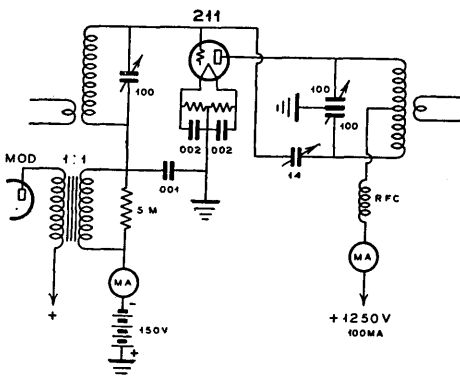

Grid-modulated r.f. amplifier.

Characteristics:

Filament Voltage10.0 volts
Filament Current3.25 amps.
Amplification Factor12
Grid-to-Plate Capacitance14.5 μ fd.
Grid-to-Filament Capacitance6 μ fd.
Plate-to-Filament Capacitance5.5 μ fd.
Maximum Plate Dissipation100 watts
Base4-pin, 50-watt

Class-B Modulator (A.F.):

D.C. Plate Voltage1000	1250 volts
Zero Signal Plate Current (Per Tube)10	10 ma.
Zero Grid Bias-77	-100 volts
Maximum Signal Plate Current (Per Tube)160	160 ma.
Load Resistance (Plate-to-Plate)6900	9000 ohms
Power Output (2 Tubes)200	260 watts

R.F. Amplifier Service:

	Class-B	Class-C	Class-C	
	Telephony	Telephony	Telephony	Doubler
D.C. Plate Voltage1250	1000	1250	1250 volts
D.C. Plate Current106	150	165	145 ma.
D.C. Grid Bias-100	-260	-215	-712 volt.
D.C. Grid Current			
(Approx.)zero	35	20	30 ma.

Grid Driving Power (Approx.)	14	7.3	26 watts
Grid Bias Loss	9	4.3	21 watts
Power Input	133	150	208 180 watts
Approx. Power Output	42.5	100	150 120 watts
Approx. A.C. Load Impedance	3300	3800	4870 ohms
Modulator D.C. Load Resistance	6666 ohms

WE-284D

WESTERN ELECTRIC triode for audio-frequency applications.

Characteristics:

Filament Voltage	10 volts
Filament Current	3.25 amps.
Maximum Plate Voltage	1250 volts
Mutual Conductance	2500 μ mhos.
D.C. Plate Current	175 ma.
Class-A Output, 2 Tubes	50 watts
Class-B Output, 2 Tubes	165 watts

203A

Class-B audio service and as an r.f. amplifier.

Frequency Range: 100% ratings up to 6 Mc., 50% at 30 Mc.

Note: The grid drive requirements vary with load impedance; circuit design and high-frequency circuit losses; thus, the driver should be able to deliver twice as much power as listed for grid drive and bias loss.

Characteristics:

Filament Voltage	10 volts
Filament Current	3.25 amps.
Amplification Factor	25
Maximum Plate Dissipation	100 watts
Grid-to-Plate Capacitance	14.5 μ fd.
Grid-to-Filament Capacitance	6.5 μ fd.
Plate-to-Filament Capacitance	5.5 μ fd.
Base	4-pin, 50-watt

Class B-Modulator or A.F. Amplifier (2 Tubes):

D.C. Plate Voltage	1000	1250 volts
D.C. Grid Bias	-35	-45 volts
Zero Signal D.C. Plate Current (Per Tube)	13	13 ma.
Maximum Signal D.C. Plate Current (Per Tube)	160	160 ma.
Load Resistance (Plate-to-Plate)	6900	9000 ohms
Power Output	200	260 watts

R.F. Service

	Class-B		Class-C		Frequency Doubler
	R.F.	Teleg. ephony	Teleg. raphy		
D.C. Plate Voltage	1250	1000	1250	1000	1000 volts
D.C. Plate Current	106	150	160	126	126 ma.
D.C. Grid Bias	-45	-135	-130	-495	100 volts
D.C. Grid Current	...	50	25	20	20 ma.
Grid Drawing Power (Approx.)	...	7	7	13	13 watts
Grid Bias Loss	...	6.8	3.3	5	5 watts
Power Input	133	150	200	126	126 watts
Approx. Power Output	42.5	90	125	80	80 watts
Approx. A.C. Load Impedance	...	3300	3900	4200	4800 ohms
Modulator D.C. Load Resistance	...	6666 ohms

838

Most used as class-B modulator due to its zero bias characteristic.

R.f. Frequency Range: 100% ratings up to 30 Mc., 65% at 60 Mc., 50% at 90 Mc.

Note (1): Push-pull 2A3 tubes in class-A will serve as a driver for class-B 838 tubes. The class-B input transformer should have a turns ratio of Prim.

$\frac{1}{2}$ sec. = 3.2 if fixed bias is used on the 2A3s. A little greater ratio of stepdown is desirable if the 2A3 drivers are self-biased.

Note (2): For r.f. the driver should have approx. twice as much output as listed in the table in order to compensate for variations of load impedance circuit design and range of frequency of operation.

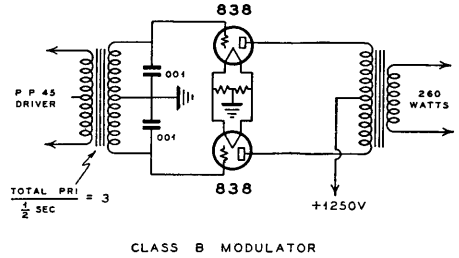

Characteristics:

Filament Voltage	10 volts
Filament Current	3.25 amps.
Amplification Factor	varies with amplitude of signal
Maximum Plate Dissipation	100 watts
Grid-to-Plate Capacitance	8 μ fd.
Grid-to-Filament Capacitance	6.5 μ fd.
Plate-to-Filament Capacitance	5 μ fd.
Maximum D.C. Plate Voltage	1250 volts
Maximum D.C. Plate Current	175 ma.
Maximum D.C. Grid Current	70 ma.
Base	4-pin, 50-watt

Class-B Modulator:

D.C. Plate Voltage	1000	1250 volts
D.C. Grid Voltage	0	0 volts
Approx. Peak A.F. Grid Input Voltage	90	90 volts
Zero Signal D.C. Plate Current (Per Tube)	53	74 ma.
Maximum Signal D.C. Plate Current (Per Tube)	160	160 ma.
Load Resistance (Plate-to-Plate)	7600	11200 ohms
Maximum Power Output (2 Tubes)	200	260 watts
Peak Driving Power (Approx.)	5	5 watts

R.F. Service

	Class-B		Class-C		Frequency Doubler
	R.F.	Teleg. ephony	Teleg. raphy		
D.C. Plate Voltage	1250	1000	1250	1000	1000 volts
D.C. Plate Current	106	150	155	157	157 ma.
D.C. Grid Bias	0	-135	-90	-465	100 volts
D.C. Grid Current	60*	60	30	20	20 ma.
Grid Driving Power (Approx.)	10*	17.5	6	12.3	12.3 watts
Grid Bias Loss	...	8	2.7	9.3	9.3 watts
Power Input	133	150	195	157	157 watts
Approx. Power Output	42.5	100	140	100	100 watts
Approx. A.C. Load Impedance	...	3300	4070	5380	5380 ohms
Modulator D.C. Load Resistance	...	6666 ohms

* (At Peak).

845

Triode. Class-A or -AB audio amplifier in public address systems or as modulator in radio transmitters. Seldom used in r.f. amplifiers.

Characteristics:

Filament Voltage	10 volts
Filament Current	3.25 amps.
Amplification Factor (Average)	5
Grid-to-Plate Capacitance	13.5 μ fd.
Grid-to-Filament Capacitance	6.0 μ fd.
Plate-to-Filament Capacitance	6.5 μ fd.
Maximum Plate Loss	100 watts
Maximum Plate Voltage	1250 volts
Maximum Plate Current	175 ma.
Base	4-pin, 50-watt

Class-A Audio Amplifier (1 Tube):

D.C. Plate Voltage	750	1000	1250	volts
D.C. Grid Voltage	-98	-155	-209	volts
D.C. Plate Current	95	65	52	ma.
Peak Grid A.F. Voltage	93	150	204	volts
Load Resistance	3400	9000	16000	ohms
Power Output	15	21	24	watts

Class-AB Audio Amplifier (2 tubes):

D.C. Plate Voltage	1000	1250	volts
D.C. Grid Voltage	-175	-225	volts
Peak A.F. Grid-to-Grid Voltage	340	440	volts
Zero Sig. D.C. Plate Current	40	40	ma.
Max. Sig. D.C. Plate Current	220	200	ma.
Load Resistance (Plate-to-Plate)	4600	8800	ohms
Max. Sig. Power Output	75	105	watts

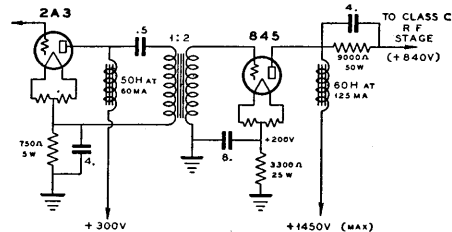

Single 845 modulator for 50-watt radiophone.

852 Triode, RCA, AMPEREX, UNITED, u.h.f. oscillator. H.f. amplifier or class-B modulator.

Frequency Range: 100% ratings up to 30 Mc., 80% at 60 Mc., 50% at 120 Mc. and 40% at 150 Mc. (2 meters).

Characteristics:

Filament Voltage	10	volts
Filament Current	3.25	amps.
Amplification Factor	12	
Grid-to-Plate Capacitance	2.6	μfds.
Grid-to-Filament Capacitance	1.9	μfds.
Plate-to-Filament Capacitance	1.0	μfds.
Maximum Plate Dissipation	100	watts
Maximum D.C. Plate Voltage	2500	volts
Maximum D.C. Plate Current	150	ma.
Maximum D.C. Grid Current	40	ma.
Base	UX 4-pin, small.	
Grid at top, plate through side of envelope.		

Class-B Modulator or R.F. Amplifier:

D.C. Plate Voltage	2000	3000	volts
D.C. Grid Voltage	-155	-250	volts
Zero Sig. Plate Current (Per Tube)	11	7	ma.
Max. Sig. Plate Current (Per Tube)	90	80	ma.
Load Resistance (Plate-to-Plate)	22000	36000	ohms
Power Output	220	360	watts

R.F. Service

	Plate Modulator		Class-C Telephony	
	Class-B Telephony	Mod. Telephony	Class-C Telephony	Class-C Telephony
D.C. Plate Voltage	3000	2000*	3000	3500
D.C. Grid Voltage	-250	-500	-600	-950
D.C. Plate Current	43	67	85	100
D.C. Grid Current	30	30	25	35
Grid Driving Power (Approx.)	23	20	44	44
Grid Bias Loss	15	15	33	33
Power Output (Approx.)	40	75	180	270
Power Input	129	134	255	350
Approx. A.C. Load Impedance	15000	17000	15000	15000
Modulator D.C. Load Resistance	30000			

*(Max.)

RK-36 RAYTHEON r.f. amplifier or oscillator for h.f. and u.h.f. applications.

Frequency Range: 100% ratings up to 56 Mc.
Note: Grid drive may vary widely under different operating conditions.

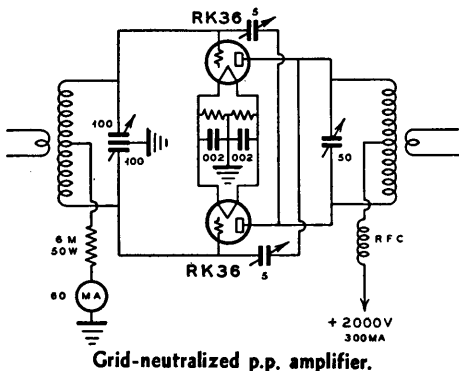

Grid-neutralized p.p. amplifier.

Characteristics:

Filament Voltage	5.0	volts
Filament Current	8.0	amps.
Amplification Factor	11	
Grid-to-Plate Capacitance	0.5	μfds.
Grid-to-Filament Capacitance	4.5	μfds.
Plate-to-Filament Capacitance	1.0	μfd.
Maximum Plate Dissipation	100	watts
Maximum D.C. Plate Voltage	3000	volts
Maximum D.C. Plate Current	165	ma.
Maximum D.C. Grid Current	35	ma.
4-prong med. base. Plate out top and grid out side of envelope. Tantalum plate.		

R.F. Service

	Grid Mod.		Class-C
	Class-B	Mod.	
D.C. Plate Voltage	2000	2000	2000
D.C. Grid Voltage	-180	-270	-380
D.C. Plate Current	75	72	150
D.C. Grid Current			30
Grid Driving Power (Approx.)	10*	3.5*	15
Grid Bias Loss			5.4
Power Output (Approx.)	50	42	200

*(Peak).

RK-38 RAYTHEON high-μ triode. Tantalum plate. Designed for class-B audio amplifier, r.f. amplifier or oscillator service. 100% ratings up to 56 Mc.

Characteristics:

Filament Voltage	5.0	volts
Filament Current	8	amps.
Grid-to-Plate Capacitance	4.5	μfds.
Grid-to-Filament Capacitance	3.9	μfds.
Plate-to-Filament Capacitance	1.0	μfd.
Maximum Plate Dissipation	100	watts
Maximum D.C. Plate Voltage	3000	volts
Maximum D.C. Plate Current	165	ma.
Maximum D.C. Grid Current	40	ma.
Standard UX 4-pin base. Plate through top, grid through side of envelope.		

R.F. Service

	Grid-Mod. Telephony		Class-C
	Class-B R.F.	Mod.	
D.C. Plate Voltage	2000	2000	2000
D.C. Grid Voltage	-100	-150	-200
D.C. Plate Current	75	80	150

D.C. Grid Current	30 ma.
Peak R.F. Grid Power	7	4 11.5 watts
Peak Audio Voltage	100	... volts
Carrier Power Output	55	60 225 watts

HK-254 * HEINTZ & KAUFMAN general purpose high-mu triode for high-frequency or class-B audio service. Tantalum plate and grid. 50-watt base. Plate through top, grid through side of glass bulb.

Characteristics:

Filament Voltage	5.0 volts
Filament Current	7.5 amps.
Amplification Factor	25
Grid-to-Plate Capacitance	3.4 μfd s.
Grid-to-Filament Capacitance	3.3 μfd s.
Plate-to-Filament Capacitance	1.1 μfd .
Normal Plate Dissipation	100 watts
Max. D.C. Plate Voltage	3000 volts
Max. D.C. Plate Current	200 ma.
Max. D.C. Grid Current	40 ma.

Class-B Audio Amplifier (2 tubes):

D.C. Plate Voltage	1000	2000	3000 volts
D.C. Grid Voltage	0	-65	-100 volts
Zero Sig. D.C. Plate Current	160	50	40 ma.
Max. Sig. D.C. Plate Current	344	261	245 ma.
Load Resistance (Plate-to-Plate)	4000	16000	30000 ohms
Power Output	146	328	550 watts

R.F. Amplifier Service, Class-C:

D.C. Plate Voltage	1000	2000	3000 volts
D.C. Grid Voltage	-40	-165	-251 volts
D.C. Plate Current	200	200	167 ma.
D.C. Grid Current	40	40	40 ma.
Effective R.F. Grid Voltage	178	284	335 volts
Driving Power (Approx.)	10	16	19 watts
Power Output	126	300	400 watts

Characteristics:

Filament Voltage	5 to 5.1 volts
Filament Current	6.5 amps.
Amplification Factor	30
Grid-to-Plate Capacitance	2 μfd s.
Grid-to-Filament Capacitance	2.2 μfd s.
Plate-to-Filament Capacitance	0.3 μfd .
Maximum D.C. Plate Voltage	3000 volts
Maximum D.C. Plate Current	225 ma.
Maximum D.C. Grid Current	50 ma.
Normal Plate Dissipation	100 watts
Base	Standard UX 4-pin, Isolantite
Plate through top, grid through side of envelope.		

Class-C R.F. Amplifier:

D.C. Plate Voltage	1000	2000	3000 volts
D.C. Plate Current	200	150	135 ma.
D.C. Grid Current	45	45	45 ma.
D.C. Grid Bias	-70	-140	-210 volts
Approx. Grid Driving Power	4.5	8	10 watts
Grid Bias Loss	3.2	6.3	9.5 watts
Approximate Power Output	120	225	300 watts

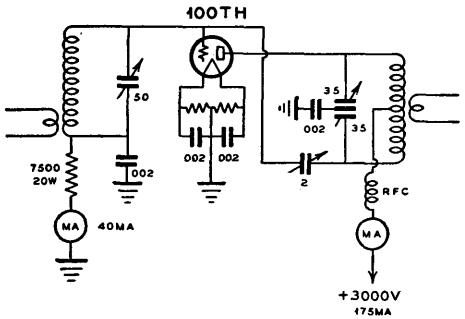

R.f. amplifier.

100TL * EIMAC u.h.f. triode with medium amplification factor. Designed primarily for diathermy service and as replacement for original Eimac 50T.

Characteristics:

Filament Voltage	5 to 5.1 volts
Filament Current	6.5 amps.
Grid-to-Plate Capacitance	2.3 μfd s.
Grid-to-Filament Capacitance	2.0 μfd s.
Plate-to-Filament Capacitance	0.4 μfd .
Normal Plate Dissipation	100 watts
Maximum D.C. Plate Voltage	3000 volts
Maximum D.C. Plate Current	225 ma.
Maximum D.C. Grid Current	35 ma.
Amplification Factor	12
Base	Standard UX 4-pin
Plate through top, grid through side of envelope.		

Class-C R.F. Amplifier:

D.C. Plate Voltage	1000	2000	3000 volts
D.C. Plate Current	200	150	135 ma.
D.C. Grid Current	30	30	30 ma.
D.C. Grid Bias	-200	-400	-600 volts
Approximate Power Output	120	225	300 watts
Approx. Grid Driving Power	7.5	13.5	21 watts
Grid Bias Loss	6	12	18 watts

Class-B Audio Amplifier:

D.C. Plate Voltage	1000	2000	3000 volts
Load Impedance (Plate-to-Plate)	5200	16000	30000 ohms
Power Output, 2 Tubes	170	350	465 watts

Class-B Audio Amplifier:

D.C. Plate Voltage	1000	2000	3000 volts
Load Impedance (Plate-to-Plate)	5200	16000	30000 ohms
Power Output, (2 Tubes)	210	380	500 watts

211C THE 211C tubes of various manufacturers (Amperex, Taylor, United) are similar to 211 tubes in operation, except for lower grid-to-plate capacitance. They are somewhat more effective at the higher frequencies down towards the u.h.f. region. See 211 tube data.

Note: The WE 261A and WE 276A are somewhat similar to the 211C in characteristics and operation.

Characteristics:

Filament Voltage	10 volts
Filament Current	3.25 amps.
Maximum Plate Dissipation	100 to 120 watts
Maximum D.C. Plate Voltage	1350 volts
Maximum D.C. Plate Current	180 ma.
Maximum D.C. Grid Current	50 ma.
Grid-to-Plate Capacitance	7 to 9 μfd s.
Grid-to-Filament Capacitance	5.5 μfd s.
Plate-to-Filament Capacitance	5 μfd s.
Base	Standard 4-pin 50-watt

100TH * EIMAC high-mu u.h.f. triode. Especially suitable for class-C r.f. amplification and class-B audio service.

850 RCA screen-grid r.f. amplifier of the 100-watt type. Primarily for replacement purposes in commercial transmitters. Superseded by more modern types such as 803 pentode.

Frequency Range: 100% ratings up to 13 Mc. 50% at 30 Mc.

Characteristics:

Filament Voltage10 volts
Filament Current3.25 amps.
Amplification Factor550
Grid-to-Plate Capacitance0.25 μ fd.
Input Capacitance17 μ fd.
Output Capacitance25 μ fd.
Maximum Plate Dissipation100 watts
Maximum D.C. Plate Voltage1250 volts
Maximum D.C. Plate Current175 ma.
Maximum D.C. Grid Current40 ma.
Maximum Screen Dissipation10 watts

860 Screen-grid tetrode. (RCA). R.f. amplifier for high frequencies. Somewhat superseded by more modern types such as 813 tetrode.
Frequency Range: 100% ratings up to 30 Mc. 80% at 40 Mc.

Characteristics:

Filament Voltage10 volts
Filament Current3.25 amps.
Amplification Factor200
Grid-to-Plate Capacitance0.08 μ fd.
Input Capacitance7.75 μ fd.
Output Capacitance7.5 μ fd.
Maximum Plate Dissipation100 watts
Maximum Screen Dissipation10 watts
BaseUX 4-pin

RK-28 RAYTHEON screen-grid tube for suppressor-modulated telephony. Buffer or final amplifier in radio transmitters. Since it is a screen grid tube, no neutralization is needed. May be used as a crystal oscillator or doubler at reduced inputs and outputs of approx. 60%.

Precaution: Input and output circuits should be shielded and all circuits carefully by-passed for r.f. Screen voltage should only be applied when plate voltage is connected.

Maximum Plate Dissipation100 watts
Maximum Screen Dissipation35 watts
Base5-pin, 50-watt. Plate at top of envelope

R.F. Service Suppressor Modulated

Class-B Telephony	Class-C Telephony	Class-C Telegraphy	
		2000	2000
D.C. Plate Voltage2000	2000	2000 volts
D.C. Screen Voltage400	400	400 volts
D.C. Suppressor Voltage0	-50	0 45 volts
D.C. Grid Bias Voltage-38	-100	-100 -100 volts
Peak R.F. Grid Voltage90	180	180 180 volts
Peak A.F. Grid Voltage90 volts
D.C. Plate Current75	80	120 140 ma.
D.C. Screen Current30	85	75 80 ma.
D.C. Grid Current11	10	10 10 ma.
Grid Driving Power0.9	2.7	1.8 1.8 watts
Grid Bias Loss1.1	1.0	1.0 1.0 watts
Power Output (Approx.)50	60	160 200 watts
Screen Resistor55000	20000	21000 26000 ohms

RK-48 RAYTHEON beam-power tetrode, designed for r.f. amplifier service. Requires very low grid excitation. Somewhat similar to RK 28, but without suppressor grid. Easier to drive than RK-28 for slightly higher power output.

Characteristics:

Filament Voltage10 volts
Filament Current5 amps.
Maximum D.C. Plate Voltage2000 volts
Maximum D.C. Screen Voltage400 volts
Maximum Plate Dissipation100 watts
Maximum Screen Dissipation35 watts
Maximum D.C. Grid Current25 ma.
Average Required D.C. Grid Current10 ma. for normal output.

Base5-prong, 50-watt
 Plate through top of envelope.

203H AMPEREX r.f. amplifier or oscillator, especially useful at high frequencies.

Note (1): The grid r.f. excitation requirements vary with efficiency, plate load and circuit design; thus, the driver must be designed to allow for these factors.

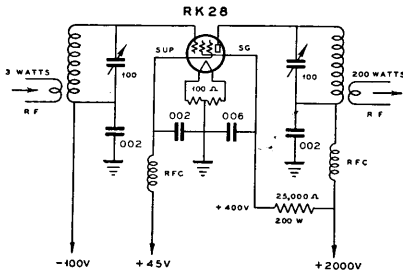

RK-28 C. w. radio-frequency amplifier.

Frequency Range: 100% ratings up to 20 Mc. The RK-28 has a lower output capacitance than the 803, so can be operated more effectively at higher frequencies, such as 14 and 30 Mc.

Note: Combined plate and screen modulation may be applied for a carrier output of 100 watts with a maximum plate supply of 1500 volts. With 400 volts d.c. on screen, 300 volts peak a.f. on it, and 1500 peak volts on the plate will provide 100% modulation.

Characteristics:

Filament Voltage10 volts
Filament Current5 amps.
Grid-to-Plate Capacitance0.02 μ fd.
Input Capacitance15.5 μ fd.
Output Capacitance5.5 μ fd.

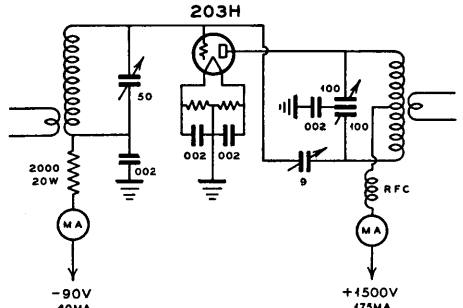

Neutralized r.f. amplifier.

(2): The plate lead is through the top of the tube; thus, it will stand higher plate voltages and operate more efficiently at higher frequencies than a regular type 203-A.

Characteristics:

Filament Voltage10 volts
Filament Current3.25 amps.
Grid-to-Plate Capacitance9 μ fds.
Grid-to-Filament Capacitance6 μ fds.
Plate-to-Filament Capacitance1.8 μ fds.
Maximum Plate Dissipation120 watts
Maximum Plate Voltage1500 volts
Maximum Plate Current180 ma.
Maximum Grid Current50 ma.
Amplification Factor25
BaseStandard 50-watt

Class-C Amplifier

	At	Less
	60 Mc.	Than 20 Mc.
D.C. Plate Voltage12001500 volts
D.C. Grid Voltage-150-180 volts
D.C. Plate Current175175 ma.
D.C. Grid Current4040 ma.
Grid Driving Power1417 watts
Grid Bias Loss67.3 watts
Power Input210263 watts
Power Output (Approx.)100180 watts

211H AMPEREX r.f. amplifier for radio transmitters.

Note (1): The grid input and plate output powers will vary greatly with different values of load impedance and frequency. The values listed are typical operating conditions.

(2): At high frequencies, circuit and dielectric losses increase and thus the grid driver should have available approximately twice as much output as shown in the table below for grid drive and bias supply power loss.

(3): This tube has the plate lead out through the top of the envelope and thus it will operate more efficiently at higher frequencies than a standard type 211 tube.

Characteristics:

Filament Voltage10 volts
Filament Current3.25 amps.
Grid-to-Plate Capacitance8.0 μ fds.
Grid-to-Filament Capacitance5.5 μ fds.
Plate-to-Filament Capacitance2.0 μ fds.
Amplification Factor12
Mutual Conductance at 100 ma. I_b4000 micromhos
Maximum Allowable Plate Dissipation120 watts
BaseStandard 4-pin, 50-watt

Class-C Amplifier

	Single	Less	
	Tube	Than	
	at 60 Mc.	20 Mc.	Telegraphy
D.C. Plate Voltage1200*1500*2000 volts
D.C. Plate Current175175180 ma.
D.C. Grid Bias-200-300-300
D.C. Grid Current303050 ma.
Grid Driving Power (Approx.)111420 watts
Grid Bias Supply Loss6915 watts
Power Output (Approx.)100190250 watts
Power Input216263360 watts
Plate Loss11673110 watts
Approx. A.C. Load Imped.350043005500 ohms
Modulator D.C. Load6850850011,100 ohms

*Maximum.

T-125* TAYLOR carbon-tantalum plate high-frequency triode, suitable as replacement tube for type 203-A.

Characteristics:

Filament Voltage10 volts
Filament Current3.85 amps.
Mutual Conductance4400 μ mhos
Amplification Factor25
Maximum Plate Dissipation125 watts
Maximum D.C. Plate Voltage2000 volts
Maximum D.C. Grid Current60 ma.
Maximum D.C. Plate Current200 ma.
Grid-to-Plate Capacitance4.5 μ fds.

BaseStandard 4-pin, 50-watt
Plate through top of envelope; grid through side.

Class-C R.F. Amplifier:

D.C. Plate Voltage2000 volts
D.C. Plate Current200 ma.
D.C. Grid Bias-200 volts
D.C. Grid Current50 ma.
Grid Driving Power (Approx.)15 watts
Grid Bias Loss10 watts
Approx. Power Output300 watts

805 RCA high- μ type tube for class-B audio service. May also be used for r.f. service.

Note (1): Plate lead out top of tube reduces flashover danger.

Frequency Range: 100% ratings up to 30 Mc., 75% at 45 Mc. and 50% at 85 Mc.

Note (2): The class-B input transformer between push-pull 2A3's (fixed bias) and class-B 805 tubes should have a turns ratio of $\frac{\text{primary}}{\text{secondary}} = 3.0$

Note (3): The grid excitation and bias may vary widely for class-C operation. It is desirable that the driver be capable of supplying approximately twice as much output as listed for grid drive and bias loss.

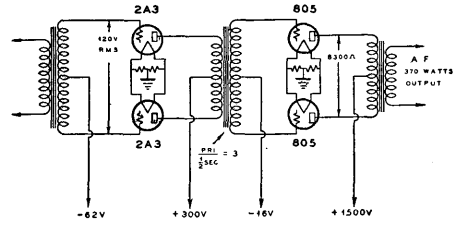

805 High power class-B modulator and driver.

Characteristics:

Filament Voltage10 volts
Filament Current3.25 amps.
Amplification Factor	Varies with Input Signal
Grid-to-Plate Capacitance6.5 μ fds.
Grid-to-Filament Capacitance8.5 μ fds.
Plate-to-Filament Capacitance10.5 μ fds.
Maximum Plate Dissipation125 watts
Maximum D.C. Plate Voltage1500 volts
Maximum D.C. Plate Current210 ma.
Maximum D.C. Grid Current70 ma.
BaseStandard 4-pin 50-watt
Plate	at top of envelope.

Class-B Modulator or A.F. Amplifier:

D.C. Plate Voltage12501500 volts
D.C. Grid Bias0-16 volts
Peak A.F. Grid-to-Grid Voltage235280 volts
Zero Sig. D.C. Plate Current (Per Tube)7442 ma.
Max. Sig. D.C. Plate Current (Per Tube)200200 ma.
Load Resistance (Plate-to-Plate)67008200 ohms
Maximum Signal Driving Power67 watts
Maximum Signal Power Output300370 watts

R.F. Service

	Plate-		
	Class-B	Mod.	Class-C
	Teleph.	Teleph.	Telegraph
	only	only	Frequency
D.C. Plate Voltage125012501500
D.C. Grid Voltage0-160-400
Peak R.F. Grid Voltage75300230
D.C. Plate Current135160200
		185 ma.

Maximum D.C. Grid Current 60 ma.
 Base Standard 4-pin, 50-watt
 Plate at top, grid at side of envelope.

Class-C R.F. Amplifier:

D.C. Plate Voltage	1500	2000 volts
D.C. Grid Voltage	-210	-300 volts
D.C. Plate Current	200	200 ma.
D.C. Grid Current	35	35 ma.
Grid Driving Power	13	19 watts
Grid Bias Loss	7.5	10 watts
Power Input	300	400 watts
Power Output	180	260 watts

813 * RCA beam power tetrode. Requires no neutralization. May be used at maximum ratings up to 30 Mc., at approximately 70 per cent of ratings up to 60 Mc., and at further reduced ratings up to 120 Mc.

R.F. Power Amplifier and Oscillator—Class-C Telegraphy:

Filament Voltage	10.0	volts
Filament Current	5 amps.
D.C. Plate Voltage (Max.)	2000 volts
D.C. Screen Voltage (Max.)	400 volts
D.C. Grid Voltage (Max.)	-300 volts
D.C. Plate Current (Max.)	180 ma.
D.C. Grid Current (Max.)25 ma.
Plate Input (Max.)	360 watts
Screen Input (Max.)22 watts
Plate Dissipation (Max.)	100 watts

Typical Operation:

D.C. Plate Voltage	1250	1500	2000	volts
D.C. Screen Voltage	300	300	400	volts
D.C. Grid Voltage	-60	-70	-90	volts
Peak R.F. Grid Voltage	145	150	160	volts
Beam Plate Voltage	0	0	0	volts
D.C. Plate Current	180	180	180	ma.
D.C. Screen Current	23	20	15	ma.
D.C. Grid Current	7	6	3	ma.
Screen Resistor	42,000	60,000	107,000	ohms
Grid Resistor	8500	11,700	30,000	ohms
Driving Power (Approx.)	1	0.8	0.5	watt
Power Output	155	190	260	watts

806 * RCA u.h.f. power triode for general use in either r.f. or audio service. Frequency range: 100% of rating up to 56 Mc.

Characteristics:

Filament Voltage	5.0	volts
Filament Current	10.0	amps.
Amplification Factor	12.6	
Grid-to-Plate Capacitance	3.4	μfd.
Grid-to-Filament Capacitance	6.1	μfd.
Plate-to-Filament Capacitance	1.1	μfd.
Maximum D.C. Plate Voltage	3000	volts
Maximum D.C. Plate Current	200	ma.
Maximum D.C. Grid Current50	ma.
Normal Plate Dissipation	150	watts

Base: Standard 50-watt; grid through side, plate through top of envelope.

Class-B Audio Amplifier (Two Tubes):

D.C. Plate Voltage	2000	3000	volts
D.C. Grid Voltage	-150	-240	volts
Zero Signal Plate Current	20	20	ma.
Max. Signal Plate Current	300	330	ma.
Load Res. (Plate-to-Plate)	11500	21500	ohms
Max. Signal Driving Power	14	10	watts
Power Output	500	680	watts

R.F. Amplifier Service:

	Class-B R.F.		Class-C Plate-Mod.		Class-C Telegraphy	
D.C. Plate Voltage	2000	3000	2500	2000	3000	3000
D.C. Grid Voltage	-150	-240	-600	-400	-600	volts
D.C. Plate Current	110	70	195	195	195	ma.
D.C. Grid Current	1	0	40	25	25	ma.
Driving Power (Approx.)	8	5	32	15	20	watts
Grid Bias Loss	0.15	0	24	10	15	watts
Power Output	70	70	390	280	450	watts

HK-354 HEINTZ & KAUFMAN triode. Tantalum plate and grid. Class-B modulator. Class-C r.f. amplifier. Maximum d.c. plate voltage for plate modulation is 3000 volts. Primarily for replacement. Superseded by HK-354C and HK-354D.

With forced ventilation, the plate dissipation may be increased to as high as 250 watts.

Frequency Range: 100% ratings up to 15 Mc. Reduced ratings at u.h.f. (above 30 Mc.).

Characteristics:

Filament Voltage	5.0	volts
Filament Current	10	amps
Amp. Factor (Avg.)	14	
Normal Plate Dissipation	150	watts
Grid-to-Plate Capacitance	4	μfd.
Grid-to-Filament Capacitance	9	μfd.
Plate-to-Filament Capacitance	0.2	μfd.
Maximum D.C. Plate Voltage	3500	volts
Maximum D.C. Plate Current	300	ma.
Maximum D.C. Grid Current50	ma.

Plate through top of envelope. Base Standard 4-Pin 50-watt.

HK-354C * HEINTZ & KAUFMAN triode. Ultra-high-frequency amplifier, tantalum plate and grid. Suitable for use as class-B modulator and class-C amplifier. All characteristics are the same as those for HK-354, except for lower grid-to-filament capacitance. The grid comes out through the side of the glass envelope, rather than through the base of the tube as in the HK-354, which makes the tube more suitable for high-frequency operation. Refer to HK-354 for characteristics and operating data.

HK-354D * HEINTZ & KAUFMAN triode. Ultra-high-frequency amplifier, doubler and class-B audio amplifier. Similar to HK-354C except for amplification factor. Best of the "354" types for all-around use.

Characteristics:

Filament Voltage	5.0	volts
Filament Current	10.0	amps.
Amplification Factor	22
Normal Plate Dissipation	150	watts
Maximum D.C. Plate Voltage	4000	volts
Maximum D.C. Plate Current	300	ma.
Maximum D.C. Grid Current50	ma.

Base: Standard 50-watt. Plate through top, grid through side of envelope.

Class-C R.F. Amplifier:

D.C. Plate Voltage	1500	2000	2500	3000	3500	volts
D.C. Grid Voltage	-236	-242	-317	-424	-490	volts
D.C. Plate Current	300	297	274	255	240	ma.
D.C. Grid Current	50	50	50	50	50	ma.
Grid Driving Power	24	26	30	35	38	watts
Grid Bias Loss	12	12	16	21	25	watts

Approximate Power Output

.....	316	445	535	614	690	watts
-------	-----	-----	-----	-----	-----	-------

R.F. Doubler:

D.C. Plate Voltage	1000	1500	2000	volts
D.C. Grid Voltage	-381	-458	-619	volts
D.C. Plate Current	250	200	175	ma.
D.C. Grid Current	50	50	50	ma.
Grid Driving Power	32	36	44	watts
Grid Bias Loss	16	22	32	watts

Approximate Power Output

.....	100	150	200	watts
-------	-----	-----	-----	-------

Class-B Audio Amplifier (Two Tubes):

D.C. Plate Voltage	1500	2000	2500	3000	volts
D.C. Grid Voltage	-60	-87	-112	-135	volts
Zero Signal D.C. Plate Current	50	50	50	50	ma.
Maximum Signal D.C. Plate Current	277	362	290	327	ma.
Plate-to-Plate Load Resistance	12000	20000	20000	21000	ohms
Power Output	302	469	519	692	watts

Suggested Driver: Four 6A5 or 45, with fixed bias and 350 volts plate supply.

HK-354E * HEINTZ & KAUFMAN triode. Similar to HK-354C and HK-354D except for mu, which is 35.

HK-354F * HEINTZ & KAUFMAN triode. Similar to HK-354C and HK-354D except for mu, which is 50.

HK55, HK155, HK255 HEINTZ & KAUFMAN Gridless Gammatrons.

Characteristics:	Type 55	Type 155	Type 255
Filament Voltage	6.0	5	14 volts
Filament Current	3	10	30 amps.
Normal Plate Dissipation	75	150	500 watts
Amplification Factor	3.5	2	3
Maximum D.C. Plate Current....	150	300	1000 ma.
Maximum D.C. Plate Voltage....	1250	3000	5000 volts
Plate Impedance	1200	1100	1000 ohms

Unusual Features: Control element is a gamma plate of tantalum.
Filament is between regular plate and gamma plate.

Uses: Oscillators, audio and radio-frequency amplifiers. Nearly complete current variation may be secured without driving the control (gamma plate) element positive.

Type 255. Interelectrode Capacitances:

Gamma Plate to Power Plate.....	5 μ fds.
Filament to Gamma Plate.....	12 μ fds.
Filament to Power Plate	7 μ fds.

Type 255 Class-A Audio Amplifier (Single Tube with no Grid (Gamma) Current):

D.C. Plate Voltage... 1500	2000	2500	3000 volts
D.C. Grid Voltage... -350	-570	-800	-1000 volts
D.C. Plate Current... 340	250	200	170 ma.
Load Resistance 5000	6000	8000	20000 ohms
Output Power..... 60	125	175	180 watts
Efficiency	12	25	35 36%
Harmonic Distortion (Approx.)	5	5	5 5%

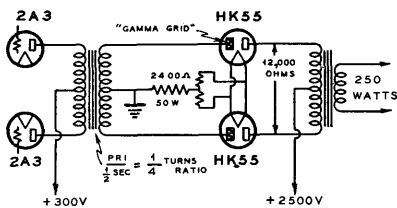

HIGH OUTPUT CLASS A AUDIO AMPLIFIER

Type 255 Class-B Audio Amplifier (2 Tubes, "Grids" Swinging to Zero and Draw No Current):

D.C. Plate Voltage... 2000	3000	5000	8000 volts
D.C. Grid Voltage... -800	-1200	-2100	-3300 volts
D.C. Plate Current... 600	850	900	750 ma.
Power Output	450	1100	2500 4000 watts
Plate Efficiency	38	44	56 67%
Load Resistance (Plate-to-Plate) ...	4000	5000	10000 23000 ohms
Plate Loss	750	1400	2000 2000 watts

Type 255 Class-B R.F. Amplifier (Single Tube, No "Grid" Current):

D.C. Plate Voltage .. 2000	3000	5000	8000 volts
D.C. Grid Voltage ... -800	-1200	-2100	-3300 volts

D.C. Plate Current .. 120	155	142	87 ma.
Load Resistance	1500	2000	4500 12000 ohms
Plate Loss	188	347	490 500 watts
Power Input	240	465	710 775 watts
Power Output	52	118	220 275 watts
Efficiency	21.5	25	31 36%

T-155 TAYLOR general purpose triode, suitable for u.h.f. service down to 2 meters.

Characteristics:

Filament Voltage	10 volts
Filament Current	4 amps.
Amplification Factor	20
Grid-to-Plate Capacitance	3 μ fds.
Grid-to-Filament Capacitance	2.5 μ fds.
Plate-to-Filament Capacitance	1 μ fd.
Maximum Plate Dissipation	155 watts
Maximum D.C. Plate Voltage	3000 volts
Maximum D.C. Plate Current	200 ma.
Maximum D.C. Grid Current	60 ma.
Base	Standard 4-Pin 50-watt

Plate through top, grid through side of envelope.

Class-C R.F. Amplifier:

D.C. Plate Voltage.....	2500 volts
D.C. Grid Voltage	250 volts
D.C. Plate Current	200 ma.
D.C. Grid Current	50 ma.
Grid Driving Power	22 watts
Grid Bias Loss	12.5 watts
Power Input	500 watts
Power Output	370 watts

WL461 WESTINGHOUSE ultra-high-frequency triode for medium- and high-power service. Special design of terminals for elements enables direct connection to elements, thus providing a very low inductance path to the tube electrodes. This construction, together with low interelectrode capacities, gives 5-megacycle performance at 50 megacycles and useful output up to 150 megacycles.

Characteristics:

Filament Voltage	5.0 volts
Filament Current	11.5 amps.
Amplification Factor	28
Maximum D.C. Plate Voltage	2000 volts
Maximum A.C. Plate Voltage (RMS)	2500 volts
Maximum D.C. Plate Current	250 ma.
Maximum Plate Dissipation	160 watts
Dimensions	7 1/2" long, 3 3/4" diameter
Tantalum plate, all leads out through base in special short leads for diathermy operation.	
Approximate Power Output on 50 Mc.....	200 watts

F-108A FEDERAL TEL. CO. general purpose triode. Especially suitable for very high frequencies.

Note: Grid excitation requirements vary greatly, due to circuit design, plate load and required efficiencies.

Frequency Range: 100% ratings up to 30 Mc.

Characteristics:

Filament Voltage	10 volts
Filament Current	11 amps.
Amplification Factor	12
Grid-to-Plate Capacitance	7 μ fds.
Grid-to-Filament Capacitance	3 μ fds.
Plate-to-Filament Capacitance	2 μ fds.
Maximum Plate Dissipation	175 watts
Maximum D.C. Plate Voltage	3000 volts
Maximum D.C. Plate Current	200 ma.
Maximum D.C. Grid Current	50 ma.

Class-C R.F. Amplifier:

D.C. Plate Voltage	2000	3000 volts
D.C. Grid Voltage	400	600 volts
D.C. Plate Current	200	200 ma.

D.C. Grid Current (Approx.)	40	40 ma.
Grid Drive	28	34 watts
Grid Bias Loss	16	24 watts
Power Input	400	600 watts
Power Output	260	480 watts

Grid Bias Loss	18 watts
Power Input	600 watts
Power Output	400 watts

HF-300* AMPEREX General purpose triode for high-frequency and u.h.f. amplifiers or oscillators.

Note: Grid excitation requirements vary greatly due to circuit design, plate load, and required efficiency.

Frequency Range: 100% ratings up to 45 Mc.

Characteristics:

Filament Voltage	11 to 12 volts
Filament Current	4 amps
Amplification Factor	23
Grid-to-Plate Capacitance	6.5 $\mu\text{fds.}$
Grid-to-Filament Capacitance	6.0 $\mu\text{fds.}$
Plate-to-Filament Capacitance	1.4 $\mu\text{fds.}$
Maximum Plate Dissipation	200 watts
Maximum D.C. Plate Voltage	2500 volts
Maximum D.C. Plate Current	275 ma.
Maximum D.C. Grid Current	75 ma.

Base.....Standard 4-Pin 50-Watt
Plate through top, grid through side of envelope.

Class-C R.F. Amplifier

D.C. Plate Voltage	1500	2500 volts
D.C. Grid Voltage	-200	-300 volts
D.C. Plate Current	275	275 ma.
D.C. Grid Current	60	60 ma.
Grid Driving Power	27	33 watts
Grid Bias Loss	12	18 watts
Power Input	420	700 watts
Power Output	260	500 watts

814 TAYLOR h.f. triode. Class-C r.f. amplifier of high output with relatively low grid driving requirements.

Frequency Range: 2 to 30 Mc.

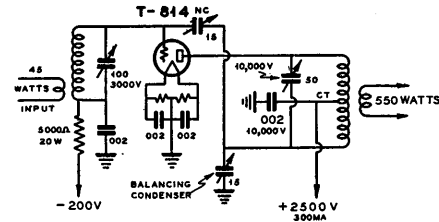

HIGH POWER FINAL AMPLIFIER

Characteristics:

Filament Voltage	10 volts
Filament Current	4 amps.
Amplification Factor	12
Grid-to-Plate Capacitance	13 $\mu\text{fds.}$
Grid-to-Filament Capacitance	7 $\mu\text{fds.}$
Plate-to-Filament Capacitance	5.5 $\mu\text{fds.}$
Maximum Plate Dissipation	200 watts
Maximum D.C. Plate Voltage	2500 volts
Maximum D.C. Plate Current	300 ma.
Maximum D.C. Grid Current	75 ma.

Base.....Standard 4-Pin 50-Watt
Plate through top of envelope.

Class-C R.F. Amplifier:

D.C. Plate Voltage	2000 volts
D.C. Grid Voltage	-400 volts
D.C. Plate Current	300 ma.
D.C. Grid Current	45 ma.
Grid Driving Power	25 watts

822* TAYLOR high-mu triode. Class B audio amplifier or modulator. May be used in class-C r.f. service.

A.F. Driver: Push-pull parallel 2A3 tubes with input transformer ratio of $\frac{\text{Primary}}{\text{Secondary}} = 1.6$.
 $\frac{1}{2}$ sec.

Characteristics:

Filament Voltage	10 volts
Filament Current	4 amps.
Amplification Factor	27
Grid-to-Plate Capacitance	14 $\mu\text{fds.}$
Grid-to-Filament Capacitance	8 $\mu\text{fds.}$
Plate-to-Filament Capacitance	6 $\mu\text{fds.}$
Maximum Plate Dissipation	200 watts
Maximum D.C. Plate Voltage	2000 volts
Maximum D.C. Plate Current	300 ma.
Maximum D.C. Grid Current	60 ma.

Base.....Standard 4-Pin 50-Watt
Plate through top of envelope.

Class-B Audio Amplifier (2 Tubes):

D.C. Plate Voltage	2000 volts
D.C. Grid Voltage (Approx.)	-75 volts
Zero Signal D.C. Plate Current	50 ma.
Maximum Signal D.C. Plate Current	450 ma.
Load Impedance (Plate-to-Plate)	9000 ohms
Power Output	500 watts
Driving Power	30 watts

Class-C R.F. Amplifier:

D.C. Plate Voltage	2000 volts
D.C. Grid Voltage	-250 volts
D.C. Plate Current	300 ma.
D.C. Grid Current	50 ma.
Grid Driving Power	20 watts
Grid Bias Loss	11 watts
Power Input	600 watts
Power Output	400 watts

T-200* TAYLOR u.h.f. triode, suitable for oscillator or amplifier service. Similar to HF-300.

Note: Grid driving requirements vary widely under different operating conditions.

Characteristics:

Filament Voltage	10 to 11 volts
Filament Current	4 amps.
Amplification Factor	16.6
Grid-to-Plate Capacitance	7 $\mu\text{fds.}$
Grid-to-Filament Capacitance	5 $\mu\text{fds.}$
Plate-to-Filament Capacitance	3 $\mu\text{fds.}$
Maximum Plate Dissipation	200 watts
Maximum D.C. Plate Voltage	2500 volts

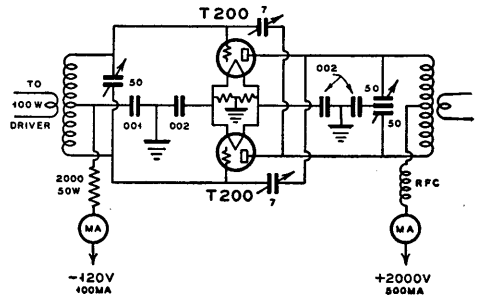

1 kw. p.p. amplifier.

Maximum D.C. Plate Current	350 ma.
Maximum D.C. Grid Current	30 ma.
Base	Standard 4-pin, 50-watt.
Plate at top, grid at side of envelope.	
Class-C R.F. Amplifier:	
D.C. Plate Voltage	2500 volts
D.C. Grid Voltage	-300 volts
D.C. Plate Current	300 ma.
D.C. Grid Current	50 ma.
Grid Driving Power (Approx.)	24 watts
Grid Bias Loss	15 watts
Power Input	750 watts
Power Output	560 watts

250TL * EIMAC. u.h.f. triode with medium amplification factor. Designed for diathermy service and for replacement of older type Eimac 150-T.

Characteristics:

Filament Voltage	5 to 5.1 volts
Filament Current	10.5 amps.
Amplification Factor	13
Grid-to-Plate Capacitance	3.5 μf ds.
Grid-to-Filament Capacitance	3.0 μf ds.
Plate-to-Filament Capacitance	0.5 μf d.
Maximum D.C. Plate Voltage	3000 volts
Maximum D.C. Plate Current	350 ma.
Maximum D.C. Grid Current	50 ma.
Normal Plate Dissipation	250 watts
Base	Standard 50-watt
Plate through top, grid through side of envelope.	

Class-C R.F. Amplifier:

D.C. Plate Voltage	1000	2000	3000 volts
D.C. Plate Current	300	350	330 ma.
D.C. Grid Current	45	45	45 ma.
D.C. Grid Bias	-200	-400	-600 volts
Approx. Grid Driving Power ..	11	22	33 watts
Grid Bias Loss	9	18	27 watts
Approximate Power Output ...	200	500	750 watts

Class-B Audio Amplifier:

D.C. Plate Voltage	1250	2000	3000 volts
Load Impedance, (Plate-to-Plate)	3280	6000	12400 ohms
Power Output (2 Tubes)	540	900	1180 watts

250TH * EIMAC, high-mu u.h.f. triode. Designed primarily for r.f. amplification and class-B audio service.

Characteristics:

Filament Voltage	5 to 5.1 volts
Filament Current	10.5 amps.
Amplification Factor	32

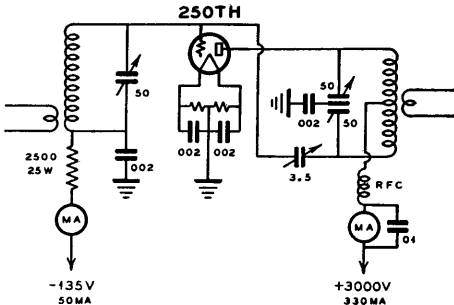

1 kw. r.f. amplifier.

Grid-to-Plate Capacitance	3.3 μf ds.
Grid-to-Filament Capacitance	3.5 μf ds.
Plate-to-Filament Capacitance	0.3 μf d.
Maximum D.C. Plate Voltage	3000 volts
Maximum D.C. Plate Current	350 ma.
Maximum D.C. Grid Current	65 ma.
Normal Plate Dissipation	250 watts
Base	Standard 50-watt
Grid through side, plate through top of envelope.	

Class-C R.F. Amplifier:

D.C. Plate Voltage	1000	2000	3000 volts
D.C. Plate Current	300	350	330 ma.
D.C. Grid Current	55	55	55 ma.
D.C. Grid Bias	-70	-140	-210 volts
Approx. Grid Driving Power ..	8	16	25 watts
Grid Bias Loss	3.9	7.7	11.6 watts
Approximate Power Output ...	200	500	750 watts

Class-B Audio Amplifier:

D.C. Plate Voltage	1000	1500	3000 volts
Load Imped. (Plate-to-Plate).2360	4200	12400 ohms	
Power Output (2 Tubes)	350	630	1180 watts
Grid Bias: Zero for plate potentials up to 1400 volts.			

WE-308B WESTERN ELECTRIC triode, designed for radiotelephone transmitters. for modulators in

Characteristics:

Filament Voltage	14 volts
Filament Current	6 amps.
D.C. Plate Current	300 ma.
Maximum Plate Voltage	2250 volts
Mutual Conductance	7500 μmhos
Class-A Output (2 Tubes)	100 watts
Class-B Output (2 Tubes)	500 watts

204A RCA - AMPEREX - UNITED. Triode Oscillator or amplifier for frequencies below 3000 kc. Used primarily in broadcast transmitters. Newer, u.h.f. types such as 833, F-200, HF 300, etc., are more suitable for high-frequency work.

Frequency Range: 100% ratings up to 3 Mc. 50% at 15 Mc.

Note: Grid excitation requirements vary with plate impedance, circuit design and circuit losses, so the driver stage should be able to supply approximately twice as much output as listed for grid drive and bias loss.

Characteristics:

Filament Voltage	11 volts
Filament Current	3.85 amps.
Amplification Factor	25
Grid-to-Plate Capacitance	15 μf ds.
Grid-to-Filament Capacitance	12.5 μf ds.
Plate-to-Filament Capacitance	2.3 μf ds.
Maximum Plate Dissipation	250 watts
Maximum D.C. Plate Voltage	2500 volts
Maximum D.C. Plate Current	275 ma.
Maximum D.C. Grid Current	80 ma.
Base	Standard 250-watt
Plate through top.	

Class-B Modulator or A.F. Amplifier:

D.C. Plate Voltage	1500	2000 volts
D.C. Grid Bias (Approx.)	-40	-60 volts
Zero Signal Plate Current (Per Tube)	37	37 ma.
Max. Signal Plate Current (Per Tube).	250	250 ma.
Load Resistance (Plate-to-Plate) ..	7800	8800 ohms
Power Output (2 Tubes)	400	600 watts

	R.F. Service		
	Class-B Telephony	Plate Mod.-Telephony	Class-C Telegraphy
D.C. Plate Voltage ...	2000	1800	1500
D.C. Grid Bias	-70	-250	-150
D.C. Plate Current	160	250	250
D.C. Grid Current	70	50	50
Power Output (Approx.)	100	300	225
Grid Driving Power	35	17	22
Grid Bias Loss	17.5	7.5	10
Power Output	140	450	375
			625

WE-212E

WESTERN ELECTRIC general purpose triode for frequencies below 1500 kc. Normally used in audio circuits.

Frequency Range: 100% ratings up to 1.5 Mc.

Characteristics:

Filament Voltage	14 volts
Filament Current	6 amps.
Amplification Factor	16
Grid-to-Plate Capacitance	18.8 μ fds.
Grid-to-Filament Capacitance	14.9 μ fds.
Plate-to-Filament Capacitance	8.6 μ fds.
Maximum Plate Dissipation	275 watts
Maximum D.C. Plate Voltage	3000 volts
Maximum D.C. Plate Current	350 ma.
Maximum D.C. Grid Current75 ma.

Special W.E. base.

Class-B Audio Amplifier (2 tubes):

D.C. Plate Voltage	1500	2000 volts
D.C. Grid Voltage	-75	-105 volts
Maximum Signal D.C. Plate Current	600	600 ma.
Zero Signal D.C. Plate Current	80	100 ma.
Load Resistance (Plate-to-Plate)	5900	8000 ohms
Power Output	500	650 watts
Driver Power	50	50 watts

R.F. Service

	Class-B R.F.	Class-C Telephony	Class-C Telegraphy
D.C. Plate Voltage	2000	2000 volts
D.C. Grid Voltage	-120	-200
D.C. Plate Current	200	300 ma.
D.C. Grid Current	60	60 ma.
Grid Drive (Approx.)	21	25 watts
Grid Bias Loss	12	15 watts
Power Input	400	600 watts
Power Output	135	400 watts

833*

RCA triode power amplifier. High-frequency r.f. amplifier with all four terminal caps out of special bulb.

Characteristics:

Filament Voltage	10 volts
Filament Current	10 amps.
Amplification Factor	35
Grid-to-Plate Capacitance	6.3 μ fds.
Grid-to-Filament Capacitance	12.3 μ fds.
Plate-to-Filament Capacitance	8.5 μ fds.
Max. D.C. Plate Current	500 ma.
Max. D.C. Plate Voltage	3000 volts
Max. Plate Input	1250 watts
Max. Plate Dissipation	300 watts
Max. D.C. Grid Current75 ma.
Max. D.C. Grid Voltage	-500 volts

R.F. Amplifier Service:

	Class-B R.F.	Class-C Telephony	Class-C Telegraphy
D.C. Plate Voltage	3000	2500
D.C. Plate Current	150	335
D.C. Grid Voltage	-70	-300
D.C. Grid Current	2	75
Grid Driving Power	10	30
Power Output	150	635

HK-654

HEINTZ AND KAUFMAN triode for class-B modulator and high-frequency r.f. service. Especially suitable for class-B r.f. and grid-modulated telephony. Tantalum plate and grid. 100% ratings up to 15 Mc.; reduced ratings above 30 Mc.

Characteristics:

Filament Voltage	7.5 volts
Filament Current	15 amps.
Amplification Factor	25
Normal Plate Dissipation	300 watts
Maximum D.C. Plate Voltage	5000 volts
Maximum D.C. Plate Current	450 ma.

Maximum D.C. Grid Current	100 ma.
Base	Standard 4-pin, 50-watt
Plate	through top, grid through side of envelope.

WE-270A

WESTERN ELECTRIC general purpose triode for broadcast station operation in high-frequency transmitters.

Frequency Range: 100% ratings up to 7.5 Mc. 33% plate voltage ratings at upper limit of 22 Mc.

Frequency Range: 100% ratings up to 7.5 Mc. 33% plate voltage ratings at upper limit of 22 Mc.

Characteristics:

Filament Voltage	10 volts
Filament Current	9.75 amps.
Amplification Factor	16
Grid-to-Plate Capacitance	21 μ fds.
Grid-to-Filament Capacitance	18 μ fds.
Plate-to-Filament Capacitance	2 μ fds.
Maximum Plate Dissipation	350 watts
Maximum D.C. Plate Voltage	3000 volts
Maximum D.C. Plate Current	375 ma.
Maximum D.C. Grid Current75 ma.

Class-B Audio Amplifier (2 Tubes):

D.C. Plate Voltage	2000	2500 volts
D.C. Grid Voltage	-105	-140 volts
Maximum Sig. D.C. Plate Current	750	750 ma.
Zero Sig. D.C. Plate Current	120	120 ma.
Load Resistance (Plate-to-Plate)	6000	8000 ohms
Power Output	850	1000 watts
Driver Power	75	75 watts

R.F. Service

	Class-B R.F.	Class-C Telephony	Class-C Telegraphy
D.C. Plate Voltage	3000	2250
D.C. Grid Voltage	-180	-300
D.C. Plate Current	175	300
D.C. Grid Current	70	70 ma.
Grid Driver (Approx.)	32	37 watts
Grid Bias Loss	21	11 watts
Power Input	525	675
Power Output	175	450

861

RCA screen grid r.f. amplifier for normal operation up to 20 megacycles.

Frequency Range: 100% ratings up to 20 Mc. 75% at 30 Mc.

Note (1): Grid driving power requirements vary over wide limits, depending upon load impedance and circuit losses.

Note (2): In modulated operation (plate type) the screen voltage should be modulated simultaneously with the plate voltage. Grid modulation characteristics are approx. similar to class-B r.f. operation, except for grid bias.

Characteristics:

Filament Voltage	11 volts
Filament Current	10 amps.
Amplification Factor	300
Grid-to-Plate Capacitance	0.1 μ fds.
Input Capacitance	14.5 μ fds.
Output Capacitance	11 μ fds.
Maximum Plate Voltage	3500 volts
Maximum Plate Dissipation	400 watts
Maximum Screen Dissipation	35 watts
Maximum D.C. Plate Current	350 ma.
Maximum D.C. Grid Current75 ma.

R.F. Service

	Class-B Telephony	Plate-Mod. Class-C Telephony	Class-C Telegraphy
D.C. Plate Voltage	3500	2000
D.C. Screen Voltage	350	500
D. C. Grid Voltage	-60	-200
D. C. Plate Current	145	265

D. C. Grid Current	70	50	60	30 ma.
Grid Driving Power	40	35	40	25 watts
Grid Bias Loss	14	15	9	7.5 watts
Plate Power Input	510	530	600	965 watts
Power Output	160	285	360	590 watts

831 RCA and AMPEREX oscillator and r.f. amplifier for high-frequency operation.
Frequency Range: 100% ratings up to 20 Mc. 55% at 75 Mc.

Note: Grid driving requirements vary greatly under different values of load impedance, neutralizing circuits and circuit losses which vary with frequency.

Characteristics:

Filament Voltage	11 volts
Filament Current	10 amps.
Amplification Factor	14.5
Grid-to-Plate Capacitance	4.0 μ fds.
Grid-to-Filament Capacitance	3.8 μ fds.
Plate-to-Filament Capacitance	1.4 μ fds.
Maximum Plate Dissipation	400 watts
Maximum D.C. Plate Voltage	3500 volts
Maximum D.C. Plate Current	350 ma.
Maximum D.C. Grid Current	75 ma.

R.F. Service:

	Class-B Telephony	Class-C Mod. Telephony	Class-C Telegraphy
D.C. Plate Voltage	3500	3000*	2000 3500 volts
D.C. Grid Voltage	220	500	200 400 volts
D.C. Plate Current	145	200	300 275 ma.
D.C. Grid Current	60	45	40 ma.
Grid Driving Power	50	25	30 watts
Grid Bias Loss	30	9	16 watts
Power Input	510	600	600 965 watts
Power Output	160	375	400 600 watts

*(Max.)

849 RCA-AMPEREX-UNITED Triode. Especially suited for class-B modulators. May be used in class-C as well as class-B r.f. amplifiers.

Frequency Range: 100% ratings up to 3 Mc. 50% at 15 Mc.

Characteristics:

Filament Voltage	11 volts
Filament Current	5.0 amps.
Amplification Factor	19
Grid-to-Plate Capacitance	33.5 μ fds.
Grid-to-Filament Capacitance	17 μ fds.
Plate-to-Filament Capacitance	3 μ fds.
Maximum Plate Dissipation	400 watts
Maximum Plate Dissipation (Telephony)	270 watts
Maximum D.C. Plate Voltage	3000 volts
Maximum D.C. Plate Current	350 ma.
Maximum D.C. Grid Current	125 ma.
Base	250 watts

Class-B Modulator or A.F. Amplifier:

D.C. Plate Voltage	2000	2500 volts
Grid Bias (Approximate)	105	130 volts
Zero Sig. Plate Current (Per Tube)	7	10 ma.
Max. Sig. Plate Current (Per Tube)	325	275 ma.
Load Resistance (Plate-to-Plate)	7040	11,430 ohms
Power Output	870	920 watts

Class-B R.F. Amplifier:

D.C. Plate Voltage	1500	2000 volts
D.C. Grid Bias	70	95 volts
D.C. Plate Current	340	265 ma.
Carrier Output	155	175 watts

Plate-Modulated Class-C Amplifier:

D.C. Plate Voltage	1500	1800 volts
D.C. Grid Bias	250	300 volts

D.C. Plate Current	300	300 ma.
Power Output	300	390 watts

Class-C Telegraphy:

D.C. Plate Voltage	1500	2000 volts
D. C. Grid Bias	175	200 volts
D.C. Plate Current	300	300 ma.
Power Output	300	450 watts
D.C. Grid Current	75	75 ma.
Grid Driving Power (Approx.)	32	34 watts
Grid Bias Loss	13	15 watts

450TH * EIMAC high-power triodes. The 450TH has an amplification factor of 32; the 450TL has an amplification factor of 16. These tubes are especially designed for broadcast and commercial transmitters. Tantalum plates and grids.

450TL *

Filament Voltage	7.5 volts
Filament Current	12 amps.
Maximum D.C. Plate Current	500 ma.
D.C. Plate Voltage	4000 volts
Normal Plate Dissipation	450 watts
Grid-to-Plate Capacitance	4.5 μ fds.
Base	Standard 50-watt type

Plate out through top and grid through side of glass envelope.

F-100A FEDERAL TEL. CO. general purpose triode for high-frequency transmitters. Useful up to 100 Mc. Pure tungsten filament.

Characteristics:

Filament Voltage	11 volts
Filament Current	25 amps.
Amplification Factor	14
Grid-to-Plate Capacitance	10 μ fds.
Grid-to-Filament Capacitance	4 μ fds.
Plate-to-Filament Capacitance	2 μ fds.
Maximum Plate Dissipation	500 watts
Maximum D.C. Plate Voltage	4000 volts
Maximum D.C. Plate Current	300 ma.

887,888 RCA u.h.f. water-cooled triodes. Designed for use as oscillators or amplifiers in the ultra-high-frequency spectrum. Either tube may be used at full input as an oscillator up to 240 Mc. or as an amplifier at full input to 300 Mc. Operation at higher frequencies is permissible with reduced input. The characteristics of the 887 are given; those of the 888 are almost identical except that the latter tube has an amplification factor of 30 and has slightly higher interelectrode capacitances.

Characteristics:

Filament Voltage	11 volts
Filament Current	24 amps.
Amplification Factor	10
Plate Dissipation (Max.)	600 watts

Direct Interelectrode Capacitances:

Grid-to-Plate	6.9 μ fds.
Grid-to-Filament	2.5 μ fds.
Plate-to-Filament	2.7 μ fds.

Type of Cooling: Water and forced air

Class-B R.F. Amplifier:

D.C. Plate Voltage (Max.)	3000 volts
D.C. Plate Current (Max.)	200 ma.
Plate Input (Max.)	600 watts

Typical Operation:

D.C. Plate Voltage	2500	3000 volts
D.C. Grid Voltage	250	300 volts
Peak R.F. Grid Voltage	290	320 volts
D.C. Plate Current	200	200 ma.
D.C. Grid Current	2	1 ma.
Driving Power	45	50 watts
Power Output	165	200 watts

Class-C Modulated Amplifier—Modulation Factor of 1.0

Maximum Conditions:

D.C. Plate Voltage (Max.)	2000 volts
D.C. Plate Current (Max.)	200 ma.
D.C. Grid Bias (Max.)	-500 volts
D.C. Grid Current (Max.)	.75 ma.
Plate Input (Max.)	400 watts
Plate Dissipation	400 watts

Class-C Amplifier—C. W. Telegraphy Maximum Conditions:

D.C. Plate Voltage	3000 volts
D.C. Grid Voltage	-500 volts
D.C. Plate Current	400 ma.
D.C. Grid Current	.75 ma.
Plate Input	1200 watts
Plate Dissipation	1000 watts

851 RCA-AMPEREX-UNITED.

High-power air-cooled triode for a.f. or r.f. service.

Frequency Range: 100% ratings up to 3 Mc. 50% at 6 Mc.

Characteristics:

Filament Voltage	11 volts
Filament Current	15.5 amps.
Amplification Factor	20
Grid-to-Plate Capacitance	.55 μ fds.
Grid-to-Filament Capacitance	.30 μ fds.
Plate-to-Filament Capacitance	.7 μ fds.
Maximum Plate Dissipation	750 watts
Maximum D.C. Plate Voltage	2500 volts
Maximum D.C. Plate Current	1000 ma.
Maximum D.C. Grid Current	200 ma.
Base	Standard 250-watt

Plate through top of envelope.

750-TL EIMAC

general-purpose triode. Tantalum grid and plate, low interelectrode capacitances and heavy leads permitting satisfactory operation at high frequencies. Used primarily in broadcast, experimental and commercial transmitters.

Characteristics:

Filament Voltage (A.C.)	7.5 to 7.7 volts
Filament Current (Approx.)	21 amps.
Amplification Factor (Average)	13.5
Grid-to-Plate Capacitance	4.5 μ fds.
Grid-to-Filament Capacitance	6.0 μ fds.
Plate-to-Filament Capacitance	0.8 μ fds.
Base	special
Overall Height	16 1/2 inches
Maximum Diameter	.7 inches

Tube must be operated vertically with ample ventilation provided.

Maximum Ratings Below 40 Megacycles:

Plate Voltage	6000 volts
Plate Current	1000 ma.
Grid Current (D.C.)	125 ma.
Normal Plate Dissipation	750 watts

HK-1554 HEINTZ & KAUFMAN

general purpose triode. Designed for commercial transmitters in the high-frequency range.

Note: Air-cooled plate. With forced ventilation, plate dissipation may be increased to 1500 watts.

Characteristics:

Filament Voltage	11 volts
Filament Current	17 amps.
Normal Plate Dissipation	750 watts
Amplification Factor	14.5 watts
Grid-to-Plate Capacitance	.11 μ fds.
Grid-to-Filament Capacitance	15.5 μ fds.
Plate-to-Filament Capacitance	1.2 μ fds.
Base	Special HK

Plate through top of envelope.

Class-B Audio Amplifier:

D.C. Plate Voltage	2500	3000	4000	5000 volts
D.C. Grid Voltage	-160	-200	-275	-350 volts
Zero Signal D.C. Plate Current (2 Tubes)	.050	.050	.050	.050 amps.
Maximum Signal D.C. Plate Cur. (2 Tubes)	1.74	1.59	1.34	1.15 amps.
Peak Driving Power	106	104	100	87 watts
RMS Signal Voltage	375	389	413	445 volts
Power Output (2 Tubes)	2850	3260	3860	4260 watts
Load Resistance (Plate-to-Plate)	3000	4200	7000	10400 ohms
Maximum Signal D.C. Grid Current (2 Tubes)	122	122	98	72 ma.

Class-B R.F. Telephony:

D.C. Plate Voltage	2500	3000	4000	5000 volts
D.C. Grid Voltage	-160	-200	-275	-350 volts
D.C. Plate Current	448	378	293	242 ma.
Plate Loss	750	750	750	750 watts
Load Resistance	750	1100	2000	3200 ohms
Peak Grid Driving Power	53	45	42	36 watts
Carrier Power	370	385	420	460 watts
Efficiency	33	34	36	38%

Class-C Operation (3000 Max. Modulation):

D.C. Plate Voltage	2500	3000	4000	5000 volts
D.C. Grid Voltage	-600	-610	-700	-760 volts
D.C. Plate Current	1.00	.930	1.00	1.00 amps.
D.C. Grid Current	110	95	104	95 ma.
Grid Driving Power	117	125	124	120 watts
Grid Bias Loss	66	58	73	72 watts
Load Resistance	1120	1460	1960	2500 ohms
Power Input	2500	2780	4000	5000 watts
Power Output	1750	2030	3040	3950 watts
Plate Efficiency	70	73	76	79%
Plate Loss	750	750	960	1050 watts

WE-251A WESTERN ELECTRIC

h.f. triode broadcast or police transmitter tube for r.f. or a.f. service.

Frequency Range: 100% ratings up to 30 Mc. 66% plate voltage ratings at 50 Mc.

Characteristics:

Filament Voltage	10 volts
Filament Current	16 amps.
Amplification Factor	10.5
Grid-to-Plate Capacitance	8 μ fds.
Grid-to-Filament Capacitance	10 μ fds.
Plate-to-Filament Capacitance	6 μ fds.
Maximum Plate Dissipation	1000 watts
Maximum D.C. Plate Voltage	3000 volts
Maximum D.C. Plate Current	600 ma.
Maximum D.C. Grid Current	150 ma.

Air-cooled tube.

R.F. Service

	Class-C	
	Class-B Tele-	Class-C
	R.F. phony	Telephony*
D.C. Plate Voltage	3000	2250 3000 volts*
D.C. Grid Voltage	-300	-470 -550 volts
D.C. Plate Current	400	400 600 ma.
Power Input	1200	900 1800 watts
Power Output	400	600 1200 watts

* (Maximum).

WE-279A WESTERN ELECTRIC

h.f. triode broadcast or police station operation for A.F. or R.F. service.

Frequency Range: 100% ratings up to 20 Mc. 50% plate voltage ratings at 40 Mc.

Characteristics:

Filament Voltage	10 volts
Filament Current	21 amps.
Amplification Factor	10
Grid-to-Plate Capacitance	13 μ fds.
Grid-to-Filament Capacitance	15 μ fds.
Plate-to-Filament Capacitance	7 μ fds.
Maximum Plate Dissipation	1200 watts
Maximum D.C. Plate Voltage	3000 volts

Maximum D.C. Plate Current800 ma.
 Maximum D.C. Grid Current150 ma.

Class-B Audio Amplifier (2 Tubes):
 D.C. Plate Voltage 2000 2500 volts
 D.C. Grid Voltage150 —200 volts
 Maximum Signal D.C. Plate Current .. 1600 1600 ma.
 Zero Signal D.C. Plate Current 220 300 ma.
 Load Resistance (Plate-to-Plate) 2240 2800 ohms
 Power Output1760 2200 watts
 Driver Power 100 100 watts

R.F. Service

	Class-B		Class-C	
	R.F.	Tele-phony	Class-C	Class-C
D.C. Plate Voltage	3000	2250	3000	3000 volts
D.C. Grid Voltage	—325	—450	—600	—600 volts
D.C. Plate Current	600	600	800	800 ma.
Power Input	1800	1350	2400	2400 watts
Power Output	600	900	1600	1600 watts

HK-3054

HEINTZ & KAUF-MAN general purpose triode for commercial application. Largest standard glass envelope tube made.

Note: Plate dissipation may be increased to 3 kw. by forced ventilation. Air cooled h.f. tube construction.

Characteristics:

Filament Voltage16 volts
Filament Current50 amps.
Normal Plate Dissipation1500 watts
Amplification Factor20
Grid-to-Plate Capacitance15 μ fd.
Grid-to-Filament Capacitance25 μ fd.
Plate-to-Filament Capacitance2.5 μ fd.
Maximum D.C. Plate Voltage5000 volts
Maximum D.C. Plate Current2000 ma.
Maximum D.C. Grid Current500 ma.

RECTIFIERS

866* -866A* -872-872A

Note: The 866-A and 872-A rectifiers are limited to 5,000 peak inverse voltage if the temperature near the base of the tube is below 15° C., or above 50° C.

Uses: Half-wave rectifiers, of the mercury-vapor type, for high-voltage plate supplies in radio transmitters. Two or four tubes may be connected in full-wave rectifier circuits. (See chapter 17.)

Max. peak inverse voltage is the highest peak voltage that the rectifier tube can safely stand in the opposite direction to which it is supposed to pass current. In a single-phase, full-wave choke input circuit, the peak inverse voltage is approx. 1.4 times the r.m.s. voltage applied to the tube. In a single phase, half-wave circuit with condenser input, the peak inverse voltage may be 2.8 times the r.m.s. value.

Max. peak plate current is the highest value of peak current that the rectifier tube can safely pass. With large choke inductance input to the filter, the peak current is not much higher than the load current. With condenser input, peak current may be 4 times as high as load current.

Characteristics:

	866	866-A	872	872-A
Filament Voltage	2.5	2.5	5.0	5.0 volts
Filament Current	5.0	5.0	10	6.75 amps.
Peak Inverse Voltage	7500	10000	7500	10000 volts*
Peak Current	.6	.6	2.5	2.5 amps*
Tube Voltage Drop (Approx.)	15	10	15	10 volts
Base	4-pin	4-pin	50-watt	50-watt

* Maximum.

866B

*TAYLOR mercury-vapor half-wave rectifier for operation in full-wave or bridge rectifier systems. Intermediate in load capacity between 866 and 872A rectifiers.

Characteristics:

Filament Voltage5 volts
Filament Current5 amps.
Peak Inverse Voltage8500 volts
Peak Current1 amp.

866 Jr.

* T A Y L O R mercury-vapor half-wave rectifier for operation in full-wave or bridge

rectifier systems. Intermediate in load capability between the type 866 and 83 rectifiers.

Characteristics:

Filament Voltage2.5 volts
Filament Current2.5 amps.
Maximum RMS A.C. Voltage1250 volts
Maximum D.C. Load Current (Choke Input)	...250 ma.
BaseUX 4-pin, Isolantite

RK-19, RK-21, RK-22

* RAYTHEON rectifiers. Intermediate between 83 and 866 rectifiers, but of high vacuum type construction. Designed for 1000-volt d.c. supplies.

Characteristics:

	Full-Wave RK-19	Half-Wave RK-21	Full-Wave RK-22
Heater Voltage	7.5	2.5	2.5 volts
Heater Current	2.5	4.0	8.0 amps.
Maximum RMS Voltage Per Plate1250 volts		
Maximum Peak Inverse Voltage3500 volts		
Maximum Peak Current600 ma.		
Maximum D.C. Load Current (with Cond. Input)	200 ma.		

KY-21

* EIMAC grid-controlled mercury-vapor type rectifier. Half-wave rectifier tube which has a control grid to permit power circuit keying. Rated to supply a d.c. load of 1.5 amperes at as high as 3500 volts with choke coil input to the filter circuit. (Full-wave operation with two tubes). Filament 2.5 volts at 10 amperes.

RX-21

*EIMAC mercury-vapor rectifier tube similar to the KY-21 except that the RX-21 has no control grid.

836

* RCA half-wave high-vacuum rectifier.

Characteristics:

Heater Voltage2.5 volts
Heater Current5 amps.
Peak Inverse Voltage5000 volts
Peak Plate Current1.0 amp.
Average Plate Current0.25 amp.
BaseStandard 4-pin
Plate through top of bulb.	

CHAPTER 11

Transmitter Theory

Oscillator, Multiplier and Amplifier Operation—Neutralization—Excitation Requirements—Tank Condenser Specifications—Interstage Coupling—Keying

EARLIER in this text it was indicated that all electrical circuits conducting alternating currents radiate some electrical energy in the form of radio or electromagnetic waves. The amount of this radiation depends upon the ratio of the dimensions of the circuit to a wavelength. Thus, it can be seen that with higher frequencies, and consequently shorter wavelengths, it becomes increasingly possible to radiate more and more electrical energy. Physical limitations in radiator dimensions prevent the efficient radiation of truly low frequencies; an efficient radiator of ordinary 50- or 60-cycle currents would require circuit dimensions to be thousands of miles in length. Radio-frequency radiators, however, may be measured in feet. The transmitting antenna is just such a radiator.

The amount of radiated energy released from any antenna is proportional to the square of the radio-frequency current flowing in that antenna. Resonating the antenna circuit to the frequency of the wave to be transmitted greatly increases this current. This, then, ordinarily is attempted. Antenna problems were considered more fully in an earlier chapter. The transmitter, essentially a generator of the radio-frequency power, is considered here.

Various methods have been used in the past to generate r.f. power. Today, however, such power virtually always is obtained from *vacuum tube* oscillators and amplifiers. The transmitters are of two general types: c.w. (continuous wave) or code transmitters; and phone or voice transmitters.

The essential portions of a c.w. trans-

mitter are the crystal oscillator, frequency doubler or doublers, and r.f. amplifiers. The crystal oscillator determines the frequency in the short-wave spectrum at which the transmitter will operate; frequency doublers multiply the relatively low frequency of the crystal oscillator when high-frequency operation is desired; the r.f. amplifier increases the output of the source of frequency control to the desired value before connection to the antenna circuit. Intermediate r.f. amplifiers are called *buffer amplifiers*; their use is necessary where the output of the crystal oscillator or frequency doubler is insufficient to drive the final r.f. amplifier for normal operation. The final r.f. amplifier stage is a converter of direct current power into radio-frequency power, which then is supplied to the antenna system for transmission of signals.

Circuit Analysis

A simple c.w. telegraph transmitter is shown schematically in figure 1. The *crystal oscillator* portion of the transmitter consists of the tuned circuit L_1-C_1 , the type 47 pentode tube, various resistors and condensers, and the *quartz crystal*. The quartz crystal has *piezoelectric* properties; that is, the crystal will vibrate physically at a *resonant frequency* as long as some electrical stimulus is applied to it. This stimulus is obtained from r.f. feedback through the plate-to-grid interelectrode capacity of the type 47 tube. The tuned circuit L_1-C_1 is tuned to a point near *resonance*. A surge, such as is obtained when the plate voltage is applied to the type 47 tube, will start an oscillation which is

controlled by the frequency of the quartz crystal. Only a small portion of the oscillating energy in the plate circuit L_1-C_3 is needed to maintain the crystal in oscillation; the main portion of the power output can be used to drive the grid circuit of a buffer-amplifier, as shown in figure 1, or to drive the grid circuit of a frequency doubler, as explained later in this chapter.

The quartz crystal circuit acts as a sharply tuned resonant circuit which has a very high Q . The latter is an index of the ability of the crystal to maintain constant frequency of oscillation. The Q is much higher for the crystal than for an ordinary tuned circuit. A crystal-controlled oscillator, therefore, has much better frequency stability than self-excited oscillators of the tuned-grid-tuned plate, *Hartley* or *Colpitts* variety.

Each of the various resistors and condensers in the oscillator circuit of figure 1 serves a separate and distinct function. Resistor R_1 provides a path for the direct current component in the grid circuit of the type 47 tube. When the tube is oscillating, the grid circuit is positive with respect to the filament for a portion of each cycle, which causes a flow of electrons to the grid electrode; the resultant pulsating direct current flows through the resistance R_1 . The direct current cannot flow through the quartz crystal because the crystal, acting like a condenser in this respect,

prevents direct current flow. The current which flows through R_1 causes a voltage drop proportional to the current, and provides a *negative grid bias* for proper oscillator action of the type 47 tube.

The *center-tap resistor* R_4 in the type 47 tube circuit supplies a balanced point of connection to the filament; the filament normally is operated from an alternating current source and the 60-cycle variation at the center point of the resistor R_4 is zero and does not introduce a.c. hum into the output of the oscillator.

The type 47 tube is only one of a number of pentodes suitable for crystal oscillator service. The main requirement of the tube is that very little grid drive or r.f. excitation be necessary to maintain stable oscillation in the tuned plate circuit L_1-C_3 . As a general rule pentode or tetrode tubes, especially those of the "beam" type, requires and have less r.f. feedback into the quartz crystal circuit than triode tubes.

The screen-grid in a tetrode or pentode tube tends to shield the plate circuit electrostatically from the control grid circuit, and also causes the tube to operate with less grid excitation than that used by a similar tube without a screen-grid. This screen-grid must be *by-passed* to the filament (or cathode) of the tube which, in turn, is connected to a common ground and the negative B supply. The screen-grid of a type 47 tube should be operated at a positive

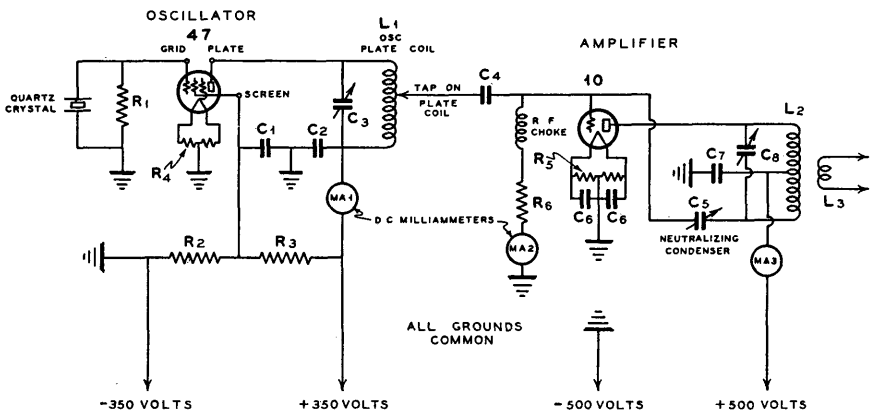

CRYSTAL OSCILLATOR — BUFFER - AMPLIFIER CIRCUIT

FIGURE 1.

potential of from 100 to 125 volts, and this voltage is obtained from the 350-volt plate supply by connecting two resistors (R_2 and R_3) across the positive and negative terminals of the 350-volt supply in the manner of a voltage divider.

The tuned plate circuit, L_1-C_3 , must be connected from the plate to the filament of the vacuum tube. This is accomplished by means of the condenser C_2 , which bypasses the r.f. to filament, yet at the same time prevents the plate circuit from being short-circuited. The plate circuit r.f. power output ranges from 25% to 50% of the d.c. power input for different types of crystal oscillators. A meter or meter jack should be connected in the plate circuit of the crystal oscillator to aid in tuning of the circuit.

Buffer-Amplifier

The r.f. power from the crystal oscillator usually is amplified to secure greater output. A large variety of tubes can be used for amplifier circuits. For the purpose of illustration, a type 10 triode tube is shown in figure 1. This tube has its grid to filament circuit connected across part of the plate circuit of the crystal oscillator. The filament of the type 10 circuit is connected to the common ground by means of a center-tap resistor R_5 , or by a center-tap connection on the filament transformer proper.

The filament voltage of a type 10 tube is three times as high as that required for a type 47 tube, and the resistance R_5 therefore is made from three to five times as high in value as the 47 filament resistor. This increase in resistance adds an appreciable amount of impedance to the flow of r.f. current from the center point of R_5 to the actual filament of the type 10 tube. To provide a low impedance path for r.f., two filament by-pass condensers C_6 should be connected from filament to ground. The grid of the amplifier tube is connected to the oscillator circuit L_1-C_3 through a coupling condenser, C_4 , which isolates the grid circuit from the oscillator plate supply, and yet enables r.f. current to flow to the grid circuit.

The position of the tap on the coil L_1 and the capacity of condenser C_4 , determines the amount of grid circuit drive. The closer this tap is to the bottom end of coil L_1 (which is at r.f. ground

potential), the lower will be the r.f. voltage on the grid of the amplifier tube.

The grid circuit of the amplifier requires actual power to operate the tube in the usual class-C operation. When the grid is driven positive, it has an average finite value of impedance, and this forms the output load for the crystal oscillator.

The grid of the type 10 amplifier tube for class-C operation must be biased to more than cutoff voltage, which is a function of the plate voltage and amplification constant of the amplifier tube. The rectified current flows through the r.f. choke, resistor R_6 and meter MA_2 to ground, the latter being the return circuit to the filament. This rectified current flowing through R_6 must be sufficient to bias the amplifier tube at least to cutoff, and normally is made high enough to reach twice this value. Correct values of grid current and grid bias voltage are listed in the *Transmitter Tube Tables*. The radio-frequency choke in series with R_6 is needed in cases where the resistance of R_6 is relatively low. Actual values of resistances and capacities are shown in numerous circuits throughout this *Handbook*.

The type 10 amplifier tube is a triode; it has a capacity of several micro-microfarads between its grid and plate electrodes. When the plate circuit is tuned to the same frequency as the grid-driving circuit L_1-C_3 , the type 10 tube will act as a regenerative self-excited oscillator unless it is neutralized. When the grid-to-plate capacitance of the tube is balanced by means of a neutralizing condenser C_5 , connected in a circuit of the type shown in figure 1, there is no feedback from the plate to the grid circuit. The tube acts as a stable r.f. amplifier and power can be taken from the tuned plate circuit L_2-C_3 by means of the coil L_3 .

The tuned plate tank circuit L_2-C_3 must be center-tapped to supply a radio-frequency voltage 180 degrees out of phase across each end of the inductance L_2 so as to obtain the desired neutralizing action. The r.f. voltage fed back through the tube elements from plate to grid is exactly neutralized by the feedback through the small variable condenser C_5 , which is adjusted to the same capacitance as the actual grid-to-plate capacitance of the tube. A split-stator tuning condenser often is used as a substitute for C_5 , which is shown as a single-section

variable condenser in figure 1. This provides a center-tap connection to the tuned circuit L_2 - C_2 for neutralizing purposes the same as does a by-passed center tap.

Frequency Multipliers

Quartz crystals are not ordinarily used for direct control of the output frequency of high-frequency transmitters. *Frequency multipliers* are needed to multiply the frequency to the desired value. These multipliers operate on exact multiples of the crystal frequency; a 3.6-megacycle crystal oscillator can be made to control the output of the transmitter on 7.2 or 14.4 megacycles, or even on 28.8 megacycles, by means of one or more frequency multipliers. When used at twice-frequency, as they most usually are, they are often termed *frequency doublers*. A simple doubler circuit is shown in figure 2. It consists of a vacuum tube with its plate circuit tuned to *twice* the frequency of the grid driving circuit. This doubler can be excited from a crystal oscillator, or connected to another doubler or buffer amplifier stage.

Doubling (*frequency multiplication*) is accomplished by operating the tube with extremely high grid bias in order to make the output plate circuit rich in harmonics. The grid circuit is driven

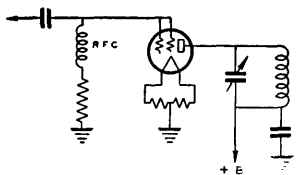

Figure 2. Simple doubler circuit with high- μ (dual-grid) triode.

approximately to normal values of d.c. grid current through the r.f. choke and grid leak resistor, shown in figure 2. The resistance value generally is from two to five times as high as that used with the tube for simple amplifying. For the same value of grid current the grid bias is several times as high.

Cutoff is calculated by dividing the d.c. plate voltage by the amplification-constant of the tube. It is that value of bias which will cut off the d.c. plate cur-

rent when no r.f. excitation is present in the grid circuit.

Neutralization is seldom absolutely necessary in a doubler circuit, since the plate is tuned to twice the frequency of the grid circuit. The feedback from the doubler plate circuit to the grid circuit is at *twice* the frequency of the grid driving circuit to which the coupling condenser (figure 2) is connected. The impedance of this external tuned grid driving circuit is very low at the doubling frequency and thus there is no tendency for self-excited oscillation when ordinary triode tubes are used. At very high frequencies however, this impedance may be great enough to cause regeneration, or even oscillation, at the tuned output frequency of the doubler.

A doubler can either be neutralized or made more regenerative by adjusting C_2 in the circuit shown in figure 3.

When condenser C_2 is of the proper value to neutralize the plate-to-grid capacity of the tube, the plate circuit can be tuned to twice the frequency (or to the same frequency) as that of the source of grid drive; the tube can be operated either as a neutralized amplifier or doubler. The capacity of C_2 can be increased so that the doubler will become *regenerative*, if the r.f. impedance of the external grid driving circuit is high enough at the output frequency of the doubler. This doubler is regenerative at its output frequency; regeneration will increase the efficiency when there is a lack of sufficient grid excitation. A doubler which receives sufficient grid excitation does not require regeneration to obtain efficiencies of from 50% to 60%. This efficiency refers to the ratio of r.f. power output to d.c. power input of the doubler plate circuit. The circuit in figure 3 generally is operated with the condenser C_2 adjusted for exact neutrali-

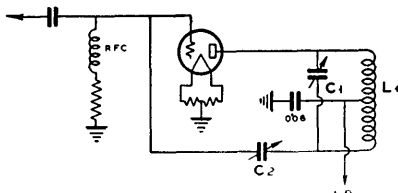

Figure 3. Regenerative doubler or neutralized buffer.

zation, so that the tube can be operated either as an amplifier or doubler for two-band operation.

Frequency doublers require *bias* of several times cutoff; high- μ tubes therefore are desirable for this type of service. Tubes which have amplification factors of from 20 to 200 are suitable for doubler circuits. Tetrodes and pentodes usually have high amplification factors. Low- μ triodes, having amplification constants of from 3 to 10, are not applicable for *doubler* service because in some cases the grid voltage must be as high as the plate voltage for efficient doubling action. The necessary d.c. grid voltage for high- μ tubes can be obtained more easily from average driver stages in conventional exciters.

Push-Push Doublers

Two tubes can be connected with the grids in push-pull, and the plates in parallel, for operation in a so-called *push-push doubler*, as shown in figure 4.

This doubler circuit will deliver twice as much output as a single-tube circuit; it has proven popular in amateur transmitters because of its *operating ease*. In previous doubler circuits, capacitive coupling was shown. *Link coupling* to the tuned circuit in a preceding stage is shown in figure 4. This coupling arrangement simplifies the push-pull connection of the two grid circuits.

The circuit C_2-L_2 is tuned to the same frequency as that of the preceding tuned circuit, and the doubler plate circuit C_1-L_1 is tuned to *twice* the frequency. The grid circuit should be tuned by means of a split-stator condenser, connected as shown in figure 4, rather than by means of the single-section tuning condenser and by-passed center-tapped coil arrangement. The latter would provide a

relatively high impedance at the doubling frequency. The push-push doubler then would be highly regenerative, and in most cases it would break into self-oscillation. The split-stator tuning circuit provides a

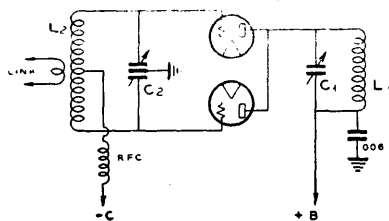

Figure 4. Push-push doubler.

capacitive reactance at the doubling frequency, so that there is very little regenerative action; the circuit, therefore, is quite stable if the grid tank is not made too low C.

Some multigrad crystal oscillators are designed so that frequency doubling can be accomplished directly in the oscillator tube circuit by connecting the various grids in push-pull (2 tubes) and the output plates in parallel.

High-power push-push doubler stages for use with such tubes as the HK-354D or 250TH may become too highly regenerative and therefore can be neutralized, as shown in the circuit in figure 5. Each tube is separately neutralized (the plate voltage having first been removed) with the plate circuit tuned to the *same frequency* as that of the grid circuit. The plate circuit then can be tuned to twice the frequency of the grid circuit (*after* the neutralizing process has been completed) without danger of self-oscillation.

Figure 5. Certain high-transconductance tubes often require neutralization when used in a push-push doubler.

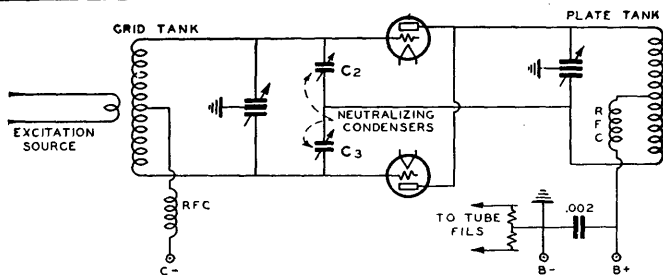

Cathode Regeneration

Another form of regenerative doubler is shown in figure 6. This circuit employs a pentode tube with its cathode only partially by-passed for radio frequencies. This provides a common impedance for both plate and grid circuits and causes a regenerative effect at high

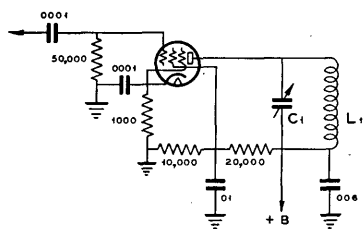

Figure 6. Regenerative high-frequency doubler utilizing common cathode impedance.

frequencies, such as 14 or 28 megacycles. The circuit tends to be *degenerative*, rather than *regenerative*, at the low frequencies.

Neutralizing Circuits

Those screen-grid tubes which have a plate-to-control grid capacitance of a small fraction of one micro-microfarad require no neutralization. All triodes and

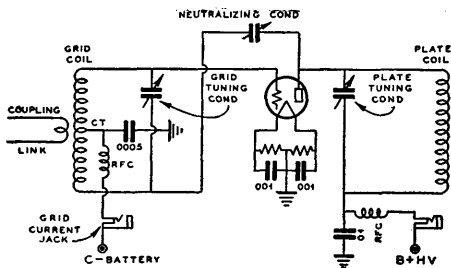

Figure 7. Grid-neutralized amplifier with series feed.

some multigrad tubes must be neutralized for r.f. amplifier service above 1500 kc. Single-tube amplifiers can be either plate or grid-neutralized. A typical *grid neutralized* circuit is shown in figure 7.

The out-of-phase neutralizing voltage is obtained by using a split-tank connection in the grid, rather than in the plate circuit.

The circuit shown in figure 7 is suitable for low- or medium-C tubes, in which the grid-to-filament capacitance is less than 8 or 10 μfd s. Tubes with higher interelectrode capacitance cannot be satisfactorily neutralized in circuits which have a single-section tuning condenser in both plate and grid circuits. The circuit in figure 7 becomes more regenerative as the frequency increases, and cannot be used at frequencies on the order of 28 megacycles. The tuning condenser which is connected across the neutralizing circuit should be of the split-stator variety for frequencies above 7 Mc. The *electrical center* of the tuning condenser (rotor of a split-stator condenser) is connected to ground, or bypassed to ground, but the center tap of the coil is *not* by-passed to ground. This holds for either plate or grid neutralization. An r.f. choke is necessary at the center tap for external connection to the plate supply or grid-bias supply. Grid and plate neutralization are equally satisfactory below 30 Mc., and the choice between the two usually depends upon the type of equipment available when building the r.f. amplifier. This point is emphasized later in this chapter, where a number of r.f. amplifier designs are treated.

A comparison between split-stator and single-section plate neutralized circuits can be seen in figure 9.

As was previously stated, the single-section condenser tuned circuit is somewhat regenerative, and therefore is more easily driven from a low power source of grid excitation. *Some* regeneration can be tolerated in an amplifier for c.w. transmission, but not for radiophone

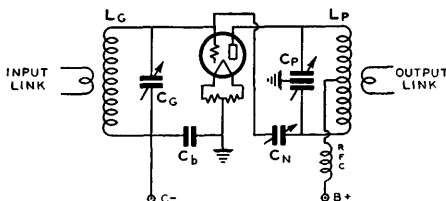

Figure 8. Plate or Hazeltine neutralization.

service. The split-stator tuned circuit *always* should be used in modulated r.f. amplifiers which operate at high frequencies. The single-section condenser tuned circuit only requires about half as much grid driving power as the split-stator tuned circuit. In c.w. transmitter design, this may eliminate one buffer stage or allow higher efficiencies to be obtained from the final amplifier. The efficiency of the final amplifier is dependent to a large extent upon the amount of grid drive; if there is a deficiency in the latter, the amplifier efficiency may drop to a low value, with attendant low r.f. power output and excessive plate dissipation.

The same grid excitation requirements hold true for the two types of grid neutralized circuits as well as for the two types of plate neutralized circuits.

Push-Pull R. F. Circuits

Two tubes can be connected for *push-pull* operation so as to obtain twice as much output as that of a single tube. A push-pull amplifier, such as that shown in figure 10, also has an advantage in that the circuit can more easily be balanced than a single-tube r.f. amplifier. The various interelectrode capacities and neutralizing condensers are connected in such a manner that those on one side of the tuned circuits are exactly equal to

those on the opposite side. For this reason, push-pull r.f. amplifiers can be more easily neutralized in very-high-frequency transmitters; also, they usually remain in perfect neutralization when tuning the amplifier to different bands.

The center tap of the grid coil is sometimes by-passed to ground; in other cases

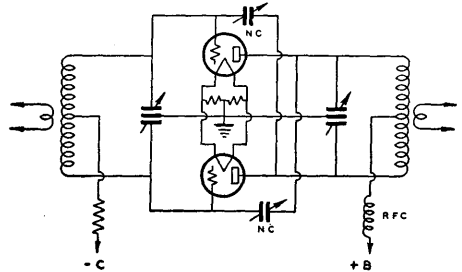

Figure 10. Push-pull r.f. amplifier stage.

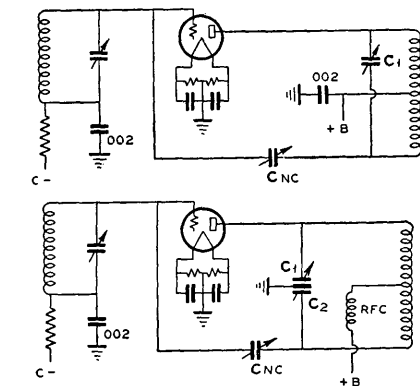

Figure 9. The upper circuit has a center-tapped plate coil by-passed to ground; the lower circuit uses a split-stator plate tuning condenser with r.f. choke in the coil center-tap connection.

it can float. It is possible to use a single-section plate tuning condenser with twice the plate spacing between adjacent plates as that of a normal split-stator tuning condenser, providing a *split-stator grid* tuning condenser is used in the push-pull amplifier. The center-tap of the plate tuned circuit should be by-passed to ground in this case.

The plate tuning condenser preferably should be of the split-stator type, with the stator connected to ground, or by-passed to ground by means of a high-voltage .002- μ fd. mica condenser in series with the rotor of the variable condenser and ground. The latter connection is particularly desirable because it prevents a d.c. arc from being formed and damaging the r.f. choke and power supply components in the event of r.f. flashover across the plates of the tuning condenser.

Neutralizing Procedure

The r.f. amplifier is neutralized to prevent self-oscillation or regeneration. A neon bulb, a flashlight lamp and a loop of wire, or an r.f. galvanometer can be used as a *null indicator* for neutralizing low-power stages. Plate voltage is disconnected from the r.f. amplifier stage while it is being neutralized. Normal

grid drive then is applied to the r.f. stage, the neutralizing indicator is coupled to the plate coil and the plate tuning condenser is tuned to resonance. The neutralizing condenser (or condensers) then can be adjusted until *minimum* r.f. is indicated for optimum settings of both grid and plate tuning condensers. Both neutralizing condensers are adjusted simultaneously when a push-pull stage is being neutralized.

A final check for neutralization should be made with a d.c. milliammeter connected in the grid leak or grid-bias circuit. There will be no movement of the meter reading as the plate circuit is tuned through resonance (without plate voltage being applied) when the stage is completely neutralized. The milliammeter check is more accurate than any other means for indicating complete neutralization and it also is suitable for neutralizing the stages of a high-power transmitter.

Push-pull circuits usually can be more completely neutralized than single-ended circuits when operating at very high frequencies. In the intermediate range of from 3 to 15 megacycles, single-ended circuits will give satisfactory results. Single-ended operation in the 3-to-15 megacycle range is most stable with split-stator tuning condensers; for example: a grid-neutralized circuit requires a split-stator grid tuning condenser, while a plate-neutralized circuit requires a split-stator plate tuning condenser.

Neutralizing Problems

When a stage cannot be completely neutralized, the difficulty can be traced to one or more of the following causes: (1) The filament leads may not be bypassed to the common ground bus connection of that particular stage. (2) The ground lead from the rotor connection of the split-stator tuning condenser to filament may be too long. (3) The neutralizing condensers may be in a field of excessive r.f. from one of the tuning coils. (4) Electromagnetic coupling may exist between grid and plate coils, or between plate and preceding buffer or oscillator circuits. (5) Insufficient shielding or spacing between stages, or between grid and plate circuits in compact transmitters may prevent neutralization or give false indications of neutralizing adjustments. (6) If shielding

is placed too close to plate circuit coils, neutralization will not be secured because of induced currents in the shields.

(7) Parasitic oscillations may take place when plate voltage is applied. The cure for the latter is to rearrange the parts, change the length of grid or plate or neutralizing leads, insert an ultra-high-frequency r.f. choke in the grid lead or leads, or eliminate the grid r.f. chokes which may be the cause of a low-frequency parasitic (in conjunction with plate r.f. chokes).

High-power amplifiers can be neutralized under normal operating conditions, when necessary, by means of a cathode-ray oscilloscope. The neutralizing condenser or condensers can first be adjusted to approximate settings from available data on grid-to-plate capacities and a knowledge of the maximum and minimum capacities of the neutralizing condensers. The latter can be adjusted for exact neutralization under normal conditions by observing the wave pattern on the oscilloscope.

Grid Excitation

Sufficient grid excitation must be available for class-B or class-C service. The excitation for a plate-modulated class-C stage must be sufficient to drive a normal value of d.c. grid current through the bias supply of about 2½ times cutoff. The bias voltage preferably should be obtained from a combination of grid leak and fixed C-bias supply. Cutoff bias can be calculated by dividing the amplification factor of the tube into the d.c. plate voltage. This is the value normally used for class-B amplifiers (fixed bias, no grid leak). Class-C amplifiers use from 1½ to 5 times this value, depending upon the available grid drive, or excitation, and the desired plate efficiency. Less grid excitation is needed for c.w. operation, and the values of fixed bias (if greater than cutoff) may be reduced, or the value of the grid leak resistor can be lowered until normal d.c. grid current flows. This value should be between 75% and 100% of the value listed under tube characteristics.

The values of grid excitation listed for each type of tube may be reduced by as much as 50% if only moderate power output and plate efficiency are desired. When consulting the tube tables, it is well to remember that the values listed

are those actually used by the tube for grid excitation. The power lost in the grid bias supply in the form of IR loss or charging current, plus that lost in the tuned circuits, must be taken into consideration when calculating the available grid drive. At very high frequencies, the r.f. circuit losses may be greater than the power lost in the grid bias, plus that which is useful for grid drive.

Readjustments in the tuning of the oscillator, buffer or doubler circuits, will result in greater grid drive to the final amplifier. The actual grid driving power is proportional to the d.c. voltage developed across the grid leak (or bias supply) multiplied by the d.c. grid current.

Link coupling between stages, particularly to the final amplifier grid circuit, normally will provide more grid drive than can be obtained from other coupling systems. The number of turns in the coupling link and the location of the turns on the coil can be varied with respect to the tuned circuits to obtain the greatest grid drive for allowable values of buffer or doubler plate current. Slight readjustments sometimes can be made after plate voltage has been applied.

Excessive grid current will damage the tubes by overheating the grid structure; beyond a certain point of grid drive no increase in power output can be obtained for a given plate voltage.

Plate Circuit Tuning

When the amplifier is completely neutralized, reduced plate voltage should be

applied before any load is coupled to the amplifier. This reduction in plate voltage should be at least 50% of normal value because the plate current will rise to excessive values when the plate tuning condenser is not adjusted to the point of resonance. The latter is indicated by the greatest dip in reading of the d.c. plate current milliammeter; the r.f. voltage across the plate circuit is greatest at this point. With no load, the r.f. voltage may be several times as high as when operating under conditions of full load; this may result in condenser flashover if normal d.c. voltage is applied. The no-load plate current at resonance should dip to 10% or 20% of normal value. If the plate circuit losses are excessive, or if *parasitic oscillations* are taking place, the no-load plate current will be higher.

The load (antenna or succeeding r.f. stage) then can be coupled to the amplifier under test. The coupling can be increased until the plate current at resonance (greatest dip in plate current meter reading) approaches the normal values at which the tube is rated. The value at reduced plate voltage should be proportionately less in order to prevent excessive plate current load when normal plate voltage is applied. Full plate voltage should not be applied to an amplifier unless the r.f. load also is connected; otherwise the condensers will arc-over or flash-over, thereby causing an abnormally high tube plate current which may damage the tube. The tuned circuit impedance is lowered when the amplifier is loaded, as are the r.f. voltages across the tuning condenser.

TANK CIRCUIT CAPACITIES

The subject of tuning capacity values for class-C amplifiers is important for anyone building a radio transmitter. The best value of capacity can be determined closely by charts or formulas for any frequency of operation. The ratio of C to L, capacitance to inductance, depends upon the operating plate voltage and current, and upon the type of circuit. Proper choice of capacity-to-inductance ratio for resonance at any given frequency is important in obtaining low harmonic output and also low distortion

in the case of a modulated class-C amplifier.

A class-C amplifier produces a very distorted plate current wave form in the form of pulses as shown in figure 12. The LC circuit is tuned to resonance and its purpose is to smooth out these pulses into a sine wave of radio-frequency output, since any wave form distortion of the carrier frequency is illegal, causing harmonic interference in higher-frequency channels. A class-A radio-frequency amplifier would produce a sine

wave output. However, the a.c. plate current would be flowing during the full 360° of each r.f. cycle, resulting in excessive plate loss in the tube for any reasonable value of output. The class-C amplifier has a.c. plate current flowing during only a fraction of each cycle, allowing the plate to cool off during the remainder of each cycle. If the plate current is zero for 2/3 of each cycle, the *angle of plate current flow* is said to be 120°, since current is flowing during 1/3 of 360°. The tube in a class-C amplifier could have several times as much power input for a given plate loss as when used in a class-A amplifier.

The tuned circuit must have a good fly-wheel effect in order to furnish a sine-wave output to the antenna when it is receiving energy in the form of very distorted pulses such as shown in figure 12. The LC circuit fills in power over the complete r.f. cycle, providing the LC ratio is correct. The flywheel effect is generally defined as the ratio of radio-frequency volt-amperes to actual power output ratio, or VA/W. This is equivalent to Q and should not be much less than 4π , or 12.5, for a class-C amplifier. At this value of VA/W or Q, one-half of the stored energy in the LC

circuit is absorbed by the antenna. If a lower value of Q is used, the storage, power is insufficient to produce a sine (undistorted) wave output to the antenna and power will be wasted in radiation of harmonics.

Too high a value of VA/W or Q will result in excessive circulating r.f. current loss in the LC circuit and lowered output to the antenna. In high-fidelity

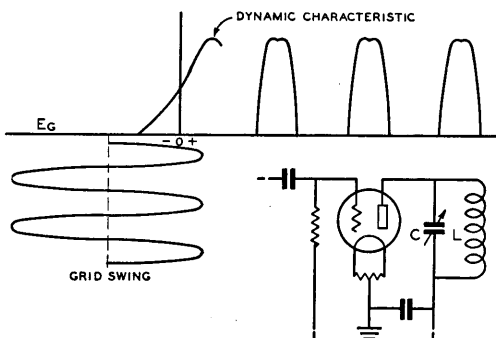

CLASS C AMPLIFIER PLATE CURRENT WAVEFORM

FIGURE 12.

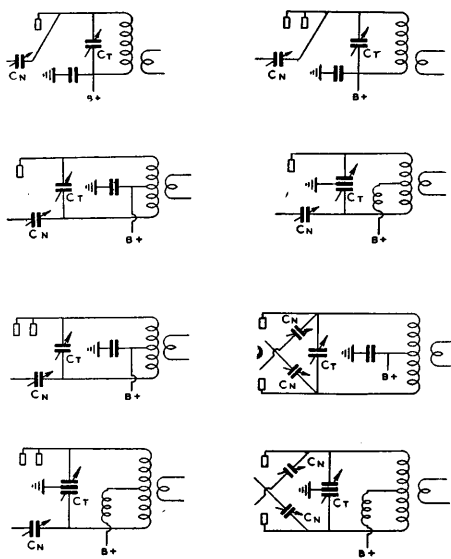

Figure 11. Typical tank circuits.

radiophone transmitters, too high a Q will cause attenuation of the higher side band frequencies and consequent loss of the higher audio frequencies. Too low a Q has its disadvantages also; so most transmitters are operated with LC circuit values of between 10 and 25. A value of 20 seems to be high enough for modulated class-C amplifiers; about 10 to 12 is enough for c.w. transmitters. With values of Q less than about 10, the maximum r.f. output will not occur at the point of minimum plate current in the amplifier tuning adjustment.

There is a wide difference in opinion as to the correct value of Q, but a careful analysis of the whole problem seems to indicate that a value of 12 is suitable for most amateur phone or c.w. transmitters. A value of 15 to 20 will result in less harmonic radiation at the expense of a little additional heat power loss in the tank or LC circuit. The charts shown have been calculated for an operating value of $Q=12$.

The curves shown in figure 13 indicate the sharp increase in harmonic output into the antenna circuit for low values

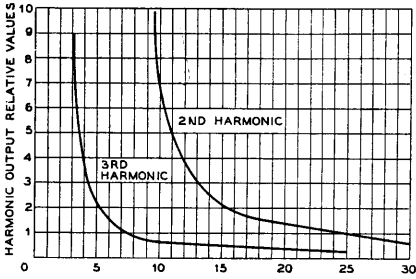

Figure 13. Harmonic output versus tank circuit Q for class-C operation.

of Q . The curve for the second harmonic rises nearly vertically for Q values of less than 10. The third harmonic does not become seriously large for values of Q greater than 4 or 5. These curves show that push-pull amplifiers may be operated at lower values of Q if necessary, since the second harmonic is cancelled to a large extent if there is no capacitive or unbalanced coupling between the tank circuit and the antenna feeder system.

Effect of Loading on Q

The Q of a circuit depends upon the resistance in series with the capacitance and inductance. This series resistance is very low for a low-loss coil not loaded by an antenna circuit. The value of Q may be from 100 to 200 under these conditions. Coupling an antenna circuit has the effect of increasing the series resistance, though in this case the power is consumed as useful radiation by the antenna. Mathematically, the antenna increases the value of R in the expression $Q = \omega L/R$ where L is the coil inductance and ω is the term $2\pi f$, f being in cycles per second.

The antenna coupling can be varied to obtain any value of Q from 3 to values as high as 100 or 200. However, the value of $Q = 12$ (or $Q = 20$ if desired) will not be obtained at normal values of d.c. plate current in the class-C amplifier tube unless the C-to-L ratio in the tank circuit is correct for that frequency of operation.

If the plate and filament of the tube are connected across the whole tuned

circuit, the impedance of the tuned circuit should match a certain a.c. impedance of the tube.

When the tube is connected across half of the tuned circuit as shown in figure 15, the tank circuit impedance must be four times as high across the complete circuit in order to match exactly the tube impedance.

In the push-pull circuit of figure 16, each tube works on a portion of each half cycle so less storage of flywheel effect is needed and a value of $Q = 6$ may be used instead of $Q = 12$.

The values of C_1 , C_2 and C_3 for the three types of class-C amplifiers are for the total capacity across the inductance. This includes the tube interelectrode capacities, distributed coil capacity, wiring capacities and tuning condenser capacity. If a split-stator condenser is used, the effective capacity is equal to half of the value of each section since the two sections are in series across the tuned circuit. The total stray capacities range from approximately 2 up to 30

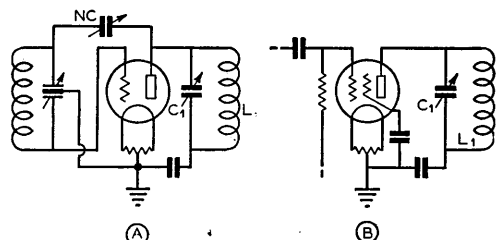
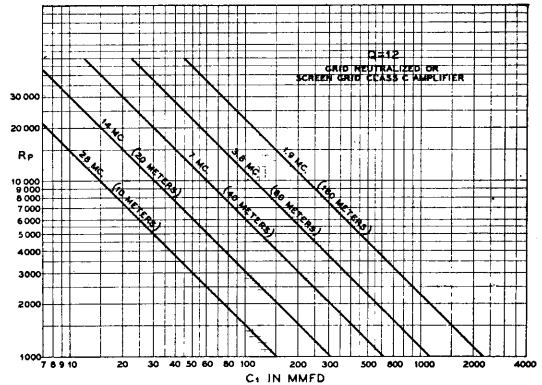

GRID-NEUTRALIZED OR SCREEN-GRID AMPLIFIER

FIGURE 14.

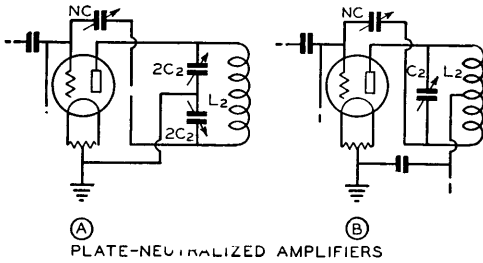
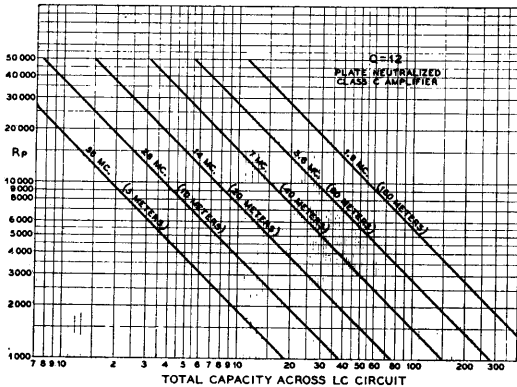

PLATE-NEUTRALIZED AMPLIFIERS

FIGURE 15.



$\mu\text{fd.}$ and largely depend upon the type of tube or tubes used in the class-C amplifier. These values may be represented over this range by 35-T's in one extreme and 203A's in the other extreme.

The values of R_p are easily calculated by dividing the d.c. plate supply voltage by the total d.c. plate current (expressed in amperes). Correct values of total

tuning capacity are shown in the charts for the different amateur bands. The shunt stray capacity can be estimated closely enough for all practical purposes. The coil inductance should then be chosen which will produce resonance at the desired frequency with the total calculated tuning capacity.

The capacities shown are the minimum

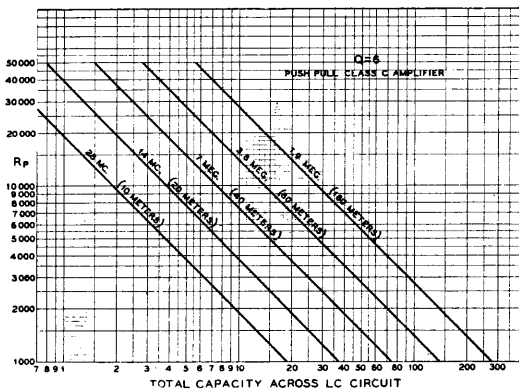
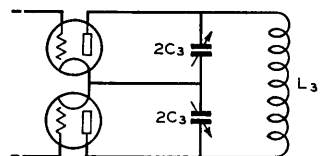

FIGURE 16
PUSH-PULL AMPLIFIER.



recommended values and they should be increased 50% to 100% for modulated class-C amplifiers where economically

feasible. The values shown in the charts are sufficient for c.w. operation of class-C amplifiers.

TUNING CONDENSER AIR GAP

Plate-Spacing Requirements for Various Circuits and Plate Voltages

The peak r.f. voltage impressed across the condenser is the important item, since the experimental and practical curves of air gap versus peak volts as published by the Allen D. Cardwell Mfg. Corp. may be applied to any condenser with polished plates having rounded edges. Typical peak breakdown voltages for corresponding air gaps are listed in the table. These values can be used in any circuit. The problem is to find the peak r.f. voltage in each case and this can be done quite easily.

The r.f. voltage in the plate circuit of a class-C amplifier tube varies from nearly zero to twice the d.c. plate voltage. If the d.c. voltage is being modulated by an audio voltage, the r.f. peaks will reach four times the d.c. voltage. These are the highest values reached in any type of loaded amplifier: a class-B linear, class-C grid- or plate-modulated or class-C c.w. amplifier. The circuits shown in figures 18 and 20 require a tuning condenser with plate spacing which will have an r.f. peak breakdown rating at least equal to 2 times or 4 times the d.c. plate voltage for c.w. and plate-modulated amplifiers respectively.

We can reduce the air gap to one-half by connecting the amplifier so that the d.c. plate voltage does not appear across the tuning condenser. This is done in figures 17 and 19. These circuits should always be used in preference to those of figures 18 and 20 since the tuning

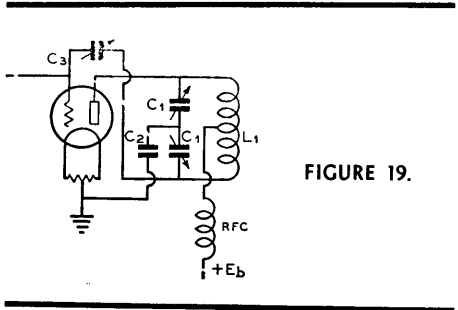

FIGURE 19.

condenser is only about one-fourth as large physically for the same capacity. Consequently, it is proportionately less expensive.

The peak r.f. voltage of a plate-modulated class-C amplifier varies at 100% modulation from nearly zero to four times E_b , the d.c. plate voltage, but only one-half of this voltage is applied across the tuning condensers of figures 17 and 19. For a class-B linear, class-C grid-modulated or c.w. amplifier, the r.f. voltage across the tube varies from nearly zero up to twice E_b . The r.f. voltage is an a.c. voltage varying from zero to a positive and then to a negative maximum over each cycle. The fixed (mica) condenser C_1 in figure 17, and C_2 in figure 19 insulates the rotor from d.c. and allows us to subtract the d.c. voltage value from the tube peak r.f. voltage value in calculating the breakdown voltage to be expected.

This gives us a simple rule to follow for a normally-loaded plate-modulated r.f. amplifier. The peak voltage across the tuning condenser C or C_1 of figures 17 and 19 respectively will be *twice the d.c. plate voltage*. If a single-section condenser is used in figure 19, with the by-pass condenser C_2 connected to the coil center tap, the plate spacing or air gap must be twice as great as that of a split-stator condenser; so there is no appreciable saving in costs for a given capacity.

For c.w. amplifiers, the air gap must be great enough to withstand a peak

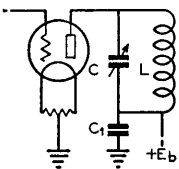

FIGURE 17.

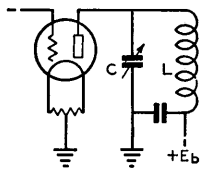

FIGURE 18.

r.f. voltage equal to the d.c. plate voltage, for each section C_1 of figure 19, or, C of figure 17.

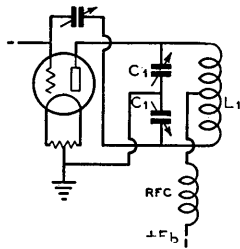

FIGURE 20.

These rules apply to a loaded amplifier or buffer stage. If the latter is ever operated without an r.f. load, the peak voltages may be very much greater —by as much as two or three times in ordinary LC circuits. For this reason no amplifier should be operated without load when anywhere near normal d.c. plate voltage is applied.

will be nearly twice as high and twice as large an air gap is needed. The fixed condensers, usually of the mica type, shown in figures 17 and 19, must be rated to withstand the d.c. plate voltage plus any audio voltage. This condenser should be rated at a d.c. working voltage of at least twice the d.c. plate supply in a plate modulated amplifier and at least equal to the d.c. supply in any other type of r.f. amplifier.

Push-Pull Amplifiers

The circuits of figures 19 and 20 apply without any change in calculations to push-pull amplifiers. Only one tube is supplying power to the tuned circuit at any given instant, each one driving a part of each half cycle. The different value of Q and increased power output increase the peak voltages slightly but for all practical purposes, the same calculation rules may be employed.

These rules are based on average amateur design for any form of r.f. amplifier with a recommended factor of safety of 100% to prevent flashover in the condenser. This is sufficient for operation into normal loads at all times, providing there are no freak parasitic oscillations present. The latter sometimes cause flashover across air gaps which should ordinarily stand several times the normal peak r.f. voltages. This is especially true of low-frequency parasitics.

The actual peak voltage values of a stable, loaded r.f. amplifier are somewhat less than the empirical calculations indicate, which gives an additional factor of safety in the design.

BREAKDOWN RATINGS OF COMMON PLATE SPACINGS

AIR-GAP IN INCHES	PEAK VOLTAGE BREAKDOWN
.030	750
.050	1500
.070	3000
.078	3500
.084	3800
.100	4150
.144	5000
.175	5700
.200	6200
.250	7200
.300	8200
.350	9250
.375	10,000
.500	12,000

A factor of safety in the air-gap rating should be applied to insure freedom from r.f. flashover. This is especially true when using the circuits of figures 2 and 4; in these circuits the plate supply is shorted when a flashover occurs. Knowing the peak r.f. voltage, an air gap should be chosen which will be about 100% greater than the breakdown rating. The air gaps listed will break down at the approximate peak voltages in the table. If the circuits are of the form shown in figures 18 and 20, the peak voltages across the condensers

Recommended Air gap (approx. 100% factor of safety) for the circuits of figures 17 and 19. Spacings should be multiplied by 1.5 for same factor of safety with circuits of figures 18 and 20.

D.C. PLATE VOLTAGE	C. W.	PLATE MOD.
400	.030	.050
600	.050	.070
750	.050	.100
1000	.070	.084
1250	.070	.144
1500	.078	.200
2000	.100	.250
2500	.175	.375
3000	.200	.500
3500	.250	.600

Figure 21. For high-powered plate-modulated transmitters it is a problem to get sufficient Q on the lower frequency bands. Fixed vacuum-type condensers similar to the one pictured on the right can be shunted across low capacity variable air condensers having high voltage breakdown. A less expensive and more compact arrangement is obtained than if a high-voltage high-capacity tuning condenser were used.

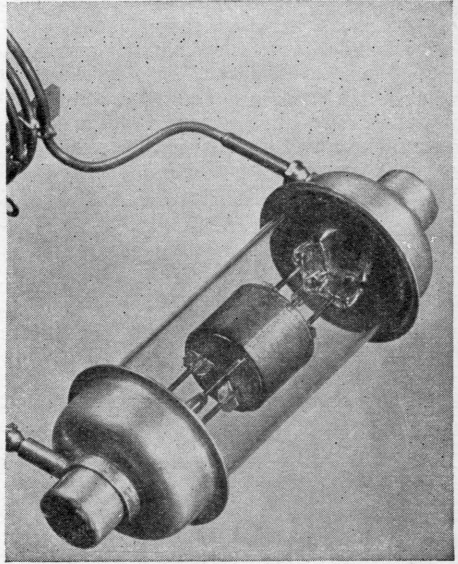

PARASITIC OSCILLATIONS IN R. F. AMPLIFIERS

Parasitics are undesirable oscillations either of very high or very low frequencies which occur in radio-frequency amplifiers.

They may cause additional signals (which are often rough in tone), other than normal harmonics, hash on each side of a modulated carrier, voltage breakdown or flashover, instability or inefficiency, and shortened life or failure of the tubes. They may be damped and stop by themselves after keying or on modulation cycles, or they may be undamped and built up during ordinary unmodulated transmission, continuing if the excitation is removed. They may be at audio or radio frequency, in either type of amplifier (though only the r.f. amplifier is treated in this discussion). They may result from series or parallel resonant circuits of all types including the dynatron. Due to the neutralizing lead length or the nature of most parasitic circuits, the amplifier usually is not neutralized for the parasitic frequency.

Sometimes the fact that the plate supply is keyed obscures parasitic oscillations that might be very severe if the plate voltage were left on and only the excitation removed.

In some cases, an all-wave receiver or an all-wave wavemeter will prove helpful in finding out if the amplifier is without spurious oscillations, but it may be necessary to check from one meter on up, to be perfectly sure. A normal harmonic is weaker than the fundamental but of good tone; a strong harmonic or a rough note at any frequency generally indicates trouble.

A familiar type of unwanted oscillation often occurs in shunt-fed circuits in which the grid and plate chokes resonate, coupled through the tube's inter-electrode capacity. It can also happen with series feed. This oscillation is generally at a lower frequency than the desired one and causes additional carriers to appear, spaced twenty to a few hundred kilocycles on either side of the main wave. One cure is to change the type of feed in either the grid or plate circuit or to eliminate one choke. Another is to use much less inductance in the grid choke than in the plate choke, or to replace the grid choke by a wire-wound resistor if the grid is series fed. In a class-C stage with grid-leak bias, no r.f. choke is required if the bias is series fed.

This parasitic may take place in push-pull circuits, in which case the tubes are effectively in parallel for the parasite and the neutralization is not effective. The grids or plates can be connected together without affecting the undesired oscillation; this is a simple test for this type of parasitic oscillation.

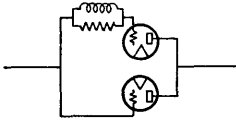

PARASITIC SUPPRESSOR FOR PARALLEL OR PUSH-PULL R F AMPLIFIERS

FIGURE 22.

Parallel Tubes

A very high frequency inter-tube oscillation often occurs when tubes are operated in parallel. Noninductive damping resistors in the grid circuit, or short interconnecting grid leads together with small plate choke coils, very likely will prove helpful.

Tapped Inductances

With capacity coupling between stages, particularly when one of the stages is tapped down from the end of the coil for loading, additional parasitic circuits are formed because of the multiple resonant effects of this complex circuit. Inductive or link coupling permits making adjustments without forming these undesired circuits. Likewise, a condenser tapped across only part of an inductance, for bandspread tuning or capacity loading, makes the situation more complex.

Multi-Element Tubes

Screen-grid and pentode tubes may help to eliminate parasitic circuits by using no neutralization, but their high gain occasionally makes parasitic oscillation easy, particularly when some form of input-output coupling exists. Furthermore, the by-pass circuit from the additional elements to the filament must be short and effective, particularly at the higher frequencies, to prevent undesired internal coupling. At the high frequen-

cies, a variable screen by-pass condenser at some settings may improve the internal shielding without causing a new parasitic oscillation. A blocking (relaxation) effect may occur if the screen is fed through a series resistor. The screen circuit can, of course, act as the plate in a tuned-grid tuned-plate oscillation that can be detuned or damped at the control grid terminal.

Crystal Stages

Crystal oscillators are seldom suspected of parasitic oscillation troubles, but are often guilty. Ordinary as well as parasitic circuit coupling between the grid and plate circuits should be held to a minimum by separating or shielding the grid and plate leads, and by reducing the area of the loop from grid through the crystal holder to the filament. Keeping the grid circuit short, even adding a small choke coil of a few turns in the plate lead next to the tube, will probably eliminate the possibility of high-voltage series-tuned parasitics.

Parasitic Suppressors

The most common type of parasitic is of the u.h.f. type, which fortunately can usually be dampened by inserting a parasitic suppressor of the type illustrated in figure 22 in the grid lead, or in one grid lead of either a push-pull or parallel tube amplifier.

Grid Bias

All amplifiers require some form of *grid bias* for proper operation. Practically all r.f. amplifiers operate in such a manner that plate current flows in the form of short peaked impulses which have a duration of only a fraction of an r.f. cycle. The plate current is cut off during the greater part of the r.f. cycle, which makes for high efficiency and high power output from the tubes, since there is no power being dissipated by the plates during a major portion of each r.f. cycle. The grid bias must be sufficient to cut off the plate current, and in very high efficiency class-C amplifiers this bias may be several times cut-off value. Cut-off bias, it will be recalled, is that value of grid voltage which will reduce the plate current to zero, and the method for calculating it has been in-

dictated previously. This theoretical value of cutoff will not reduce the plate current completely to zero, due to the variable μ tendency which is characteristic of all tubes as the cutoff point is approached. This factor, however, is of no importance in practical applications.

Radiophone class-C amplifiers should be operated with the grid bias adjusted to values between two and three times cutoff at normal values of d.c. grid current to permit linear operation (necessary when the stage is plate-modulated). C.w. telegraph transmitters can be operated with bias as low as cutoff, if limited excitation is available and high plate efficiency is not a factor. In a c.w. transmitter, the bias supply or resistor should be adjusted to the point which will allow normal grid current to flow for the particular amount of grid driving r.f. power available. This form of adjustment will allow more output from the under-excited r.f. amplifier than when twice cutoff, or higher bias is used with low values of grid current.

Grid-Leak Bias

A resistor can be connected in the grid circuit of an r.f. amplifier to provide grid-leak bias. This resistor R_1 in figure 23 is part of the d.c. path in the grid circuit.

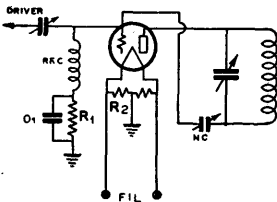
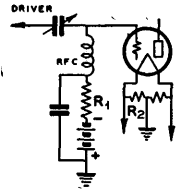

Figure 23. Illustrating grid-leak bias.

The r.f. excitation is applied to the grid circuit of the tube. This causes a pulsating d.c. current to flow through the bias supply lead and any current flowing through R_1 produces a voltage drop across that resistance. The grid of the tube is positive for a short duration of each r.f. cycle, and draws electrons from the filament or cathode of the tube during that time. These electrons complete the circuit through the d.c. grid return. The voltage drop across the

resistance in the grid return provides a *negative bias* for the grid. The r.f. chokes in figures 23, 24, 25 and 26 prevent the r.f. excitation from flowing through the bias supply, or from being short-circuited to ground. The by-pass condenser across the bias source proper is for the purpose of providing a low impedance path for the small amount of stray r.f. energy which passes through the r.f. choke.

Grid-leak bias automatically adjusts



COMBINATION BATTERY & GRID LEAK BIAS

FIGURE 24.

itself even with fairly-wide variations of r.f. excitation. The value of grid-leak resistance should be such that normal values of grid current will flow at the maximum available amount of r.f. excitation. Grid-leak bias cannot be used for grid-modulated or linear amplifiers in which the d.c. grid current is constantly varying.

Grid-leak bias alone provides no protection against excessive plate current in case of failure of the crystal oscillator, or failure of any other source of r.f. grid excitation. A *C-battery* or *C-bias* supply can be connected in series with the grid leak, as shown in figure 24. This additional C-bias should at least be made equal to cutoff bias. This will protect the tube in the event of failure of grid excitation.

Cathode Bias

A resistor can be connected in series with the cathode or center-tapped filament lead of an amplifier to secure *automatic bias*. The plate current flows through this resistor, then back to the cathode or filament, and the voltage drop across the resistor can be applied to the grid circuit by connecting the grid bias lead to the grounded, or power supply end of the resistance R , as shown in figure 25.

The grounded (B-minus) end of the cathode resistor is negative relative to the filament by an amount equal to the voltage drop across the resistor. The value of resistance must be so chosen that the desired plate current flowing through the resistor will bias the tube for proper operation at that plate current.

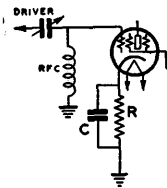

FIGURE 25.

CATHODE BIAS

This type of bias is used more extensively in audio-frequency than in radio-frequency amplifiers. The voltage drop across the resistor must be subtracted from the total plate supply voltage when calculating the power input to the amplifier, and this loss of plate voltage in an r.f. amplifier may be excessive. A class-A audio amplifier is biased only to approximately one-half cutoff, whereas an r.f. amplifier may be biased to twice cutoff, or more, and thus the plate supply voltage loss may be a large percentage of the total available voltage when using low- or medium- μ tubes.

Separate Bias Supply

C-batteries or an external C-bias supply sometimes are used for grid bias of an amplifier, as shown in figure 26.

Battery bias gives very good voltage regulation and is satisfactory for grid-modulated or linear amplifiers, which

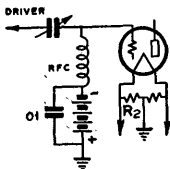

FIGURE 26.

BATTERY BIAS

operate nearly at zero grid current. In the case of class-C amplifiers which operate with high grid current, battery bias is not very satisfactory. This d.c. current has a charging effect on the dry batteries; after a few months of service the cells will become unstable, bloated and noisy.

A separate a.c. operated power supply can be used as a substitute for dry batteries. The bleeder resistance across the output of the filter can be made sufficiently low in value that the grid current of the amplifier will not appreciably change the amount of negative grid-bias voltage. This type of bias supply is used in class-B audio and class-B r.f. linear amplifier service where the voltage regulation in the C-bias supply is important. For a class-C amplifier it is not so important, and an economical design of components in the power supply therefore can be utilized.

R. F. Coupling Systems

Energy can be coupled from one circuit into another in the following ways: *capacitive coupling*, *inductive coupling* or *link coupling*. The latter is a special form of inductive coupling. The choice of a coupling method depends upon the purpose for which it is to be used.

Capacitive Coupling

The grid circuit of an amplifier or doubler circuit can be coupled to a preceding driver stage by means of a fixed or variable condenser, as shown in figure 27.

Condenser C isolates the d.c. plate supply from the next grid and provides a low impedance path for the r.f. energy between the tube being driven, and the driver tube. This method of coupling is simple and economical for low-power amplifier or exciter stages, but has certain disadvantages. The grid leads in an amplifier should be as short as possible, but this is difficult to attain in the physical arrangement of a high-power amplifier with respect to a capacitively-coupled driver stage.

The r.f. choke in series with the C-bias supply lead must offer an extremely high impedance to the r.f. circuit, and this is difficult to obtain when the transmitter is operated on several harmonically related bands. Another disadvantage of

capacitive coupling is the difficulty of adjusting the load on the driver stage. Impedance adjustment can be accomplished by tapping the coupling lead a part of the way down on the plate coil of the tuned stage of the driver circuit, as can be seen by referring back to figure 1. However, when this lead is tapped part way down on the coil, a *parasitic oscillation* tendency becomes very troublesome and is difficult to eliminate. If the driver stage has sufficient power output so that an impedance mismatch can be tolerated, the condenser C in figure 27 can be connected directly to the top of the coil, and made small enough in capacity for the particular frequency of operation that not more than normal plate current is drawn by the driver stage.

The impedance of the grid circuit of a class-C amplifier may be as low as a few hundred ohms in the case of a high- μ tube, and may range from that value up to a few thousand ohms for low- μ tubes.

Capacitive coupling places the grid-to-filament capacity of the driven tube directly across the driver tuned circuit, which reduces the LC ratio and sometimes makes the r.f. amplifier difficult to neutralize because the additional

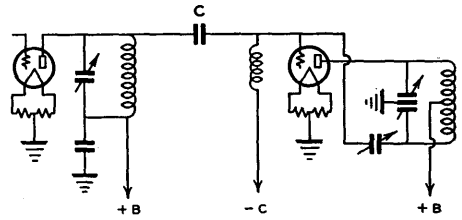

CAPACITIVE COUPLING
FIGURE 27.

driver stage circuit capacities are connected into the grid circuit.

Capacitive coupling can be used to advantage in reducing the total number of tuned circuits in a transmitter so as to conserve space and cost. It also can be used to advantage between stages for driving tetrode or pentode amplifier or doubler stages. These tubes require relatively small amounts of grid excitation.

Inductive Coupling

The r.f. amplifier often is coupled to the antenna circuit by means of *induc-*

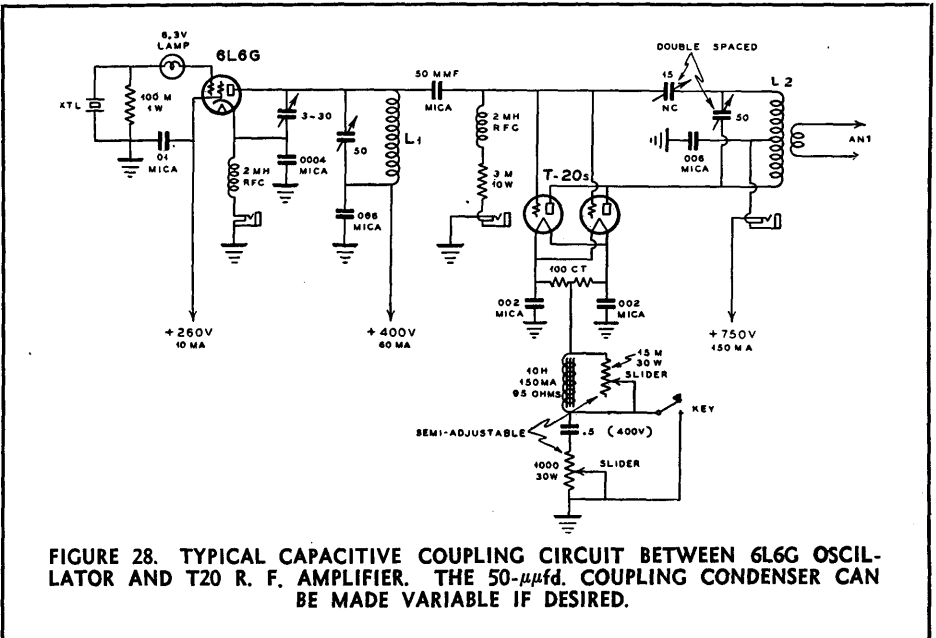
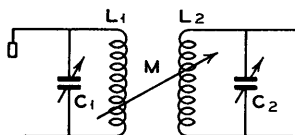

FIGURE 28. TYPICAL CAPACITIVE COUPLING CIRCUIT BETWEEN 6L6G OSCILLATOR AND T20 R. F. AMPLIFIER. THE 50- μ fd. COUPLING CONDENSER CAN BE MADE VARIABLE IF DESIRED.

tive coupling, which consists of two coils electromagnetically coupled to each other. The antenna tuned circuit can be of the series-tuned type, such as is illustrated for *Marconi*-type 160-meter antennas in the chapter on *Antennas*. Parallel resonant circuits sometimes are used, as shown in figure 29, in which the antenna feeders are connected across the whole or part of the circuit L_2 - C_2 .



INDUCTIVE COUPLING

FIGURE 29.

The degree of coupling is controlled by varying the mutual inductance of the two coils, which is accomplished by changing the spacing between the coils.

Inductive coupling also is used extensively for coupling r.f. amplifiers in radio receivers, and occasionally in transmitting r.f. amplifier circuits. The mechanical problems involved in adjusting the degree of coupling in a transmitter make this system of limited practical value.

Link Coupling

A special form of inductive coupling which is applied to radio transmitter circuits is known as *link coupling*. A low impedance r.f. transmission line, commonly known as a *link*, couples the two tuned circuits together. Each end of the line is terminated in one or more turns of wire, or *loops*, wound around the coils which are being coupled together. These loops should be coupled to each tuned circuit at the point of zero r.f. potential. This *nodal* point is the center of the tuned circuit in the case of plate-neutralized for push-pull amplifiers, and at the positive-B end of the tuned circuit in the case of screen grid and grid-neutralized amplifiers.

The nodal point in an antenna tuned circuit depends upon the type of feeders, and the node may be either at the center or at one end of the tuned circuit. The nodal point in tuned grid circuits is at the C-bias or grounded end of plate-

neutralized r.f. or screen-grid amplifiers, and at the center of the tuned grid coil in the case of push-pull or grid-neutralized amplifiers. The link coupling turns should be as close to the nodal point as possible. This ground connection to one side of the link is used in special cases where harmonic elimination is important, or where all capacitive coupling between two circuits must be minimized.

Typical link coupled circuits are shown in figures 30, 31 and 32.

Some of the advantages of link coupling are listed here:

- (1) It eliminates coupling taps on tuned circuits.
- (2) It permits the use of series power supply connections in both tuned grid and tuned plate circuits, and thereby eliminates the need of r.f. chokes.
- (3) It allows separation between transmitter stages of distances up to several feet without appreciable r.f. losses.
- (4) It reduces capacitive coupling and thereby makes neutralization more easily attainable in r.f. amplifiers.
- (5) It provides semiautomatic impedance matching between plate and grid tuned circuits, with the result that greater grid swing can be obtained in comparison to capacitive coupling.
- (6) It effectively reduces harmonic radiation when a final amplifier is coupled to a tuned antenna circuit, due to the additional tuned circuit and, particularly, it eliminates capacitive coupling to the antenna.

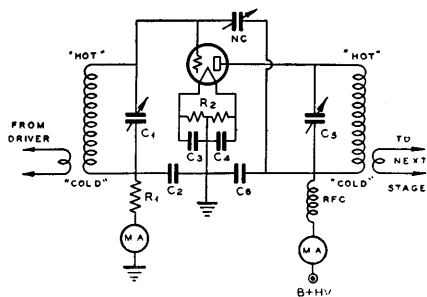

Figure 30. Link coupling between single-ended stages.

The link coupling line and loops can be made of no. 18 or 20 gauge push back wire for coupling low-power stages. High-power circuits can be link-coupled by means of no. 8 to no. 12 rubber-covered wire, or EO-1 cable.

The impedance of a link coupling line varies from 75 to 200 ohms, depending upon the diameter of the conductors and the spacing between them.

Grid Saturation

Excessive grid excitation is just as injurious to a vacuum tube as abnormal plate current or low filament operation. Too much grid driving power will overheat the grid wires in the tube, and will cause a release of gas in certain types of tubes. An excess of grid drive will not appreciably increase the power output and increases the efficiency only slightly after a certain point is reached. The grid current in the tube should not exceed the values listed in the *Tube Tables*, and care also should be exercised to have the bias voltage low enough to prevent flashover in the stem of the vacuum tube.

Grid excitation usually refers to the actual r.f. power input to the grid circuit of the vacuum tube, part of which is used to drive the tube, and part of which is lost in the C-bias supply. There is no way to avoid wasting a portion of the excitation power in the bias supply.

R. F. Chokes

Radio-frequency chokes are connected in circuits for the purpose of preventing r.f. energy from being short-circuited, or escaping into power supply circuits.

They consist of inductances wound with a large number of turns, either in the form of a solenoid or universal pie-winding. These inductances are designed to have as much inductance and as little distributed or shunt capacity as possible, since the capacity by-passes r.f. energy. The unavoidable small amount of distributed capacity resonates the inductance, and this frequency normally should be lower than the frequency at which the transmitter or receiver circuit is operating. R.f. chokes for operation on several harmonically related bands must be designed carefully so that the

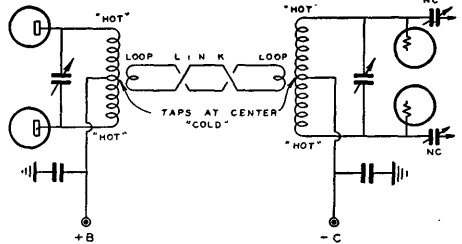

Figure 31. Link coupling between push-pull stages.

impedance of the choke will be extremely high (several hundred thousand ohms) in each of the bands.

The r.f. choke is resonant to the harmonics of its fundamental resonant frequency; however, the *even* harmonics have a very low impedance, so that an r.f. choke designed for maximum impedance in the 80-meter amateur band would not be satisfactory for operation in the 40-meter band. The harmonic

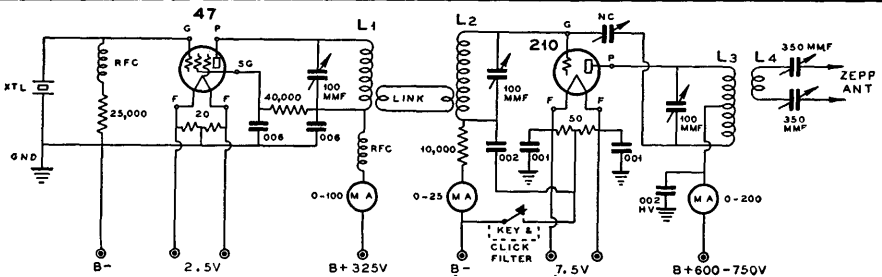

Figure 32. Complete circuit diagram of 47 oscillator link-coupled to 210 amplifier stage. One or two turns of wire are wound around coils L_1 and L_2 to form the coupling loop. The two loops are connected through a twisted-pair feedline, made with hookup wire.

resonance points of the r.f. choke usually are made to fall *between* frequency bands, so that a *reasonably* high value of impedance is obtained on *all* bands. The d.c. current which flows through the r.f. choke largely determines the size of wire to be used in the windings. The inductance of r.f. chokes for very short wavelengths is much less than for chokes designed for broadcast and ordinary short-wave operation, so that the impedance will be as high as possible in the desired range of operation. A very high inductance r.f. choke has more distributed capacity than a smaller one, with the result that it will actually offer *less* impedance at very high frequencies.

Self-Excited Oscillators

A continuously variable range in frequency control often is desirable for a radio transmitter. Some form of *self-excited oscillator* (s.e.o.) is a practical means of accomplishing this purpose. The *electron-coupled oscillator* is to be preferred because of its greater stability with respect to power supply voltage variation. Good design of a self-excited oscillator requires the use of good parts, solid connections, freedom from vibration and a power supply with a built-in voltage regulator. The construction of

an exciter of this type is more difficult and costly than is that of a crystal-controlled oscillator, for comparative stability of frequency control.

In many cases a self-excited oscillator is used as a complete transmitter, especially on the 80-meter c.w. band, employing a fairly large sized transmitter tube. Simplicity and variable frequency control are its only virtues. The output efficiency is less than can be obtained in an r.f. amplifier, and the frequency *stability* can be very poor under certain conditions.

The Conversion Exciter

When using an electron-coupled oscillator to control the frequency of a transmitter, it is of no advantage to use a very low-frequency oscillator and frequency multipliers, because while the oscillator may be made four times as stable (in terms of kilocycles, not percentage) by designing it for 500 kc. instead of 2000 kc., the fourth harmonic will drift four times as far as the fundamental. Thus, we are effectively right back where we started so far as frequency stability is concerned and might as well use a 2000-kc. oscillator.

There is, however, a system whereby the greater stability of a very low frequency oscillator can be utilized advan-

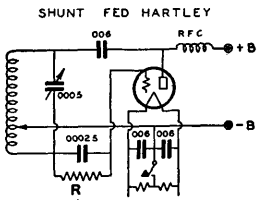

Figure 33.

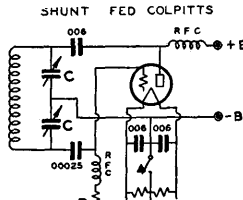

Figure 34.

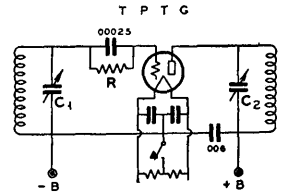

Figure 35.

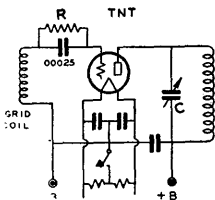

Figure 36.

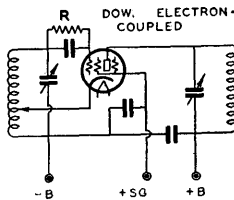

Figure 37.

**COMMON TYPES
OF SELF-EXCITED
OSCILLATORS**

tageously to provide variable frequency control in the amateur bands. A variable, low-frequency oscillator designed for good stability and covering a range of frequencies in the neighborhood of 200-600 kc., and a high-frequency crystal oscillator are both fed into a mixer tube as in the case of a superheterodyne receiver. The output of the mixer tube is tuned to either the sum or difference of the two frequencies. The frequency of the low-frequency oscillator is mixed rather than multiplied. The theoretical stability is very good because, by picking the correct beat or heterodyne (determined by whether the crystal has a positive or negative temperature coefficient), the *drift* effects of the two oscillators can be made to buck rather than add.

In actual practice it is possible to construct for covering the 80-meter band a conversion exciter unit which compares in stability to a conventional 80-meter crystal oscillator. Constructional details on such an exciter are given in the next chapter.

Shunt and Series Feed

Direct-current grid and plate connections are made either by *shunt* or *parallel feed* systems. Simplified forms of each are shown in figures 38 and 39.

Series feed can be defined as that in which the d.c. connection is made to the grid or plate circuit at a point of very

Series feed is more popular than shunt feed, since r.f. choke coils can usually be omitted.

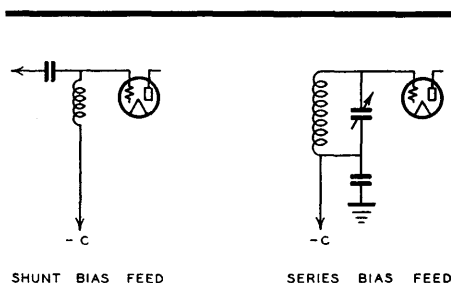

FIGURE 39.

Parallel and Push-Pull Tube Circuits

The comparative r.f. power output from parallel or push-pull operated amplifiers is the same if proper impedance matching is accomplished and if sufficient grid excitation is available in both cases.

Parallel operation of tubes has some advantages in transmitters designed for operation on 40, 80 and 160 meters, or for broadcast band operation. Only one neutralizing condenser is required for parallel operation, as against two for push-pull. However, on wavelengths below 40 meters, parallel tube operation is not advisable because of the unbalance in capacity across the tank circuits. Low-C types of vacuum tubes can be connected in parallel with less difficulty than the high-C types, in which the combined interelectrode capacities might be quite high in the parallel connection.

Push-pull operation provides a well-balanced circuit insofar as miscellaneous capacities are concerned; in addition the circuit can be neutralized more easily, especially in high-frequency amplifiers. The LC ratio in a push-pull amplifier can be made higher than in a plate-neutralized parallel-tube operated amplifier. Push-pull amplifiers, when perfectly balanced, have less second-harmonic output than parallel or single-tube amplifiers. In actual practice, undesired capacitive coupling and circuit unbalance tend to offset this theoretical advantage of push-pull r.f. circuits.

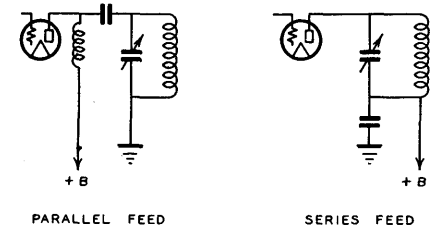

FIGURE 38.

low r.f. potential. Shunt feed always is made to a point of high r.f. voltage and always requires a high impedance r.f. choke or resistance in the connection to the high r.f. point in order to prevent loss of r.f. power.

C. W. TELEGRAPHY KEYING

The carrier frequency signal from a c.w. transmitter must be broken into dots and dashes in the form of *keying* for the transmission of code characters. The carrier signal is of a constant amplitude while the key is closed, and is entirely removed when the key is open. If the change from the *no-output* condition to *full-output* occurs too rapidly, an undesired *key-click* effect takes place which causes interference in other signal channels. If the opposite condition of full output to no output condition occurs too rapidly, a similar effect takes place.

The two general methods of keying a c.w. transmitter are those which control either the excitation, or the plate voltage which is applied to the final amplifier. Direct plate voltage control can be obtained by connecting the key in the primary line circuit of the high voltage plate power supply. A slight modification of direct plate voltage control is the connection of the c.w. key or relay in the filament center-tap lead of the final amplifier. *Excitation keying* can be of several forms, such as crystal oscillator keying, buffer stage keying or blocked-grid keying.

Key clicks should be eliminated in all c.w. telegraph transmitters. Their elimination is accomplished by preventing a too-rapid make-and-break of power to the antenna circuit. A gradual application of power to the antenna, and a similarly slow cessation, will eliminate key clicks. Too much lag will prevent fast keying, but fortunately key clicks can be practically eliminated without limiting the speed of manual (hand) keying. Some circuits which eliminate key clicks introduce too much time-lag and thereby add *tails* to the dots. These tails may cause the signals to sound chirpy, or make them difficult to copy at high speeds.

The elimination of key clicks by some of the key-click filter circuits illustrated in the following text is not easily applied to every individual transmitter. The constants in the time-lag and spark-producing circuits depend upon the individual characteristics of the transmit-

ter, such as the type of filter, power input and various circuit impedances. All keying systems have one or more disadvantages, so that no particular method can be recommended as an ideal one. An intelligent choice can be made by the reader for his particular transmitter requirements by carefully analyzing the various keying circuits.

Primary Keying

Key clicks can be eliminated entirely by means of primary keying, in which the key is placed in the a.c. line supply to the primary of the high voltage plate supply transformer. This method of keying also has the advantage that grid leak bias can be used in the keyed stages of the transmitter. As ordinarily applied, the plate voltage to the final amplifier is controlled by the action of the key. The filter in the high voltage rectifier circuit creates a time-lag in the application and removal of the d.c. power input to the r.f. amplifier. Too much filter will introduce too great a time lag, and add tails to the dots. If a high-power stage is keyed, the variation in load of the house-lighting circuits may be sufficient to cause blinking of the lights. A heavy-duty key or keying relay is necessary for moderate or high-power transmitters to break the inductive a.c. current. The exciting current or surge current may be several times as high as the average current drawn by the transformer which is being keyed. This will cause difficulty from sticking key contacts or burnt points on the keying relay. This effect can be minimized by proper design of the power transformer, which should have a high primary inductance and an iron core of generous size.

An improved primary keying circuit is shown in figure 40. This circuit makes high speed keying possible, without clicks or tails, and the plate supply to the final amplifier can be very well filtered without introducing tails to the dots.

The final amplifier must have a fixed bias supply equal to more than cut off

value, so that when the grid excitation from the buffer stage is removed the amplifier output will drop immediately to zero, in spite of the filter condenser's being fully charged in the final amplifier circuit. The bleeder across the final plate supply filter should have a very high resistance so that the filter condenser will hold its charge between dots and dashes. This will allow a quick application of plate voltage as soon as the grid excitation, supplied by the buffer stage, is applied to the final amplifier.

The buffer plate supply is keyed; its filter circuit consists of a single 2- μ fd. filter condenser, shunted by the usual heavy-duty high-current bleeder resistor. This small filter has no appreciable time-lag, and will not add tails to the dots and dashes, but it does provide sufficient time-lag for key click elimination. The small amount of filter will not introduce a.c. hum modulation into the output of the final amplifier, because the latter is operated in class-C, under saturated grid conditions. A moderate a.c. ripple in the grid excitation will not introduce hum in the output circuit under this operating condition.

Grid-Controlled Rectifiers

By the incorporation of grid-controlled rectifiers in a high-voltage power

supply, one can enjoy keying that has practically all the advantages of primary keying with none of the disadvantages. The only drawback of this type of keying as compared to primary keying is that of the small amount of additional equipment needed and the additional expense of the special rectifiers.

Inasmuch as no power is required to block the grids, there is little sparking at the relay contacts. And because the keying is ahead of the power supply filter, the wave train or keying envelope is rounded enough that clicks and keying impacts are eliminated. In fact, it is important that no more filter be used than is required to give a good T-9 note, inasmuch as excessive filter will introduce lag and put tails on the keying. The optimum ratio and amounts of inductance and capacity in the filter will be determined by the load on the filter (plate voltage divided by plate current). With high plate voltage and low plate current (high impedance load) more inductance and less capacity should be used, and vice versa.

Of the large number of possible circuit combinations, two of the most practical are illustrated. The circuit shown in figure 41 at A is perhaps the simplest and most trouble-free, but has the disadvantage of requiring bias batteries. The relay contacts handle little power,

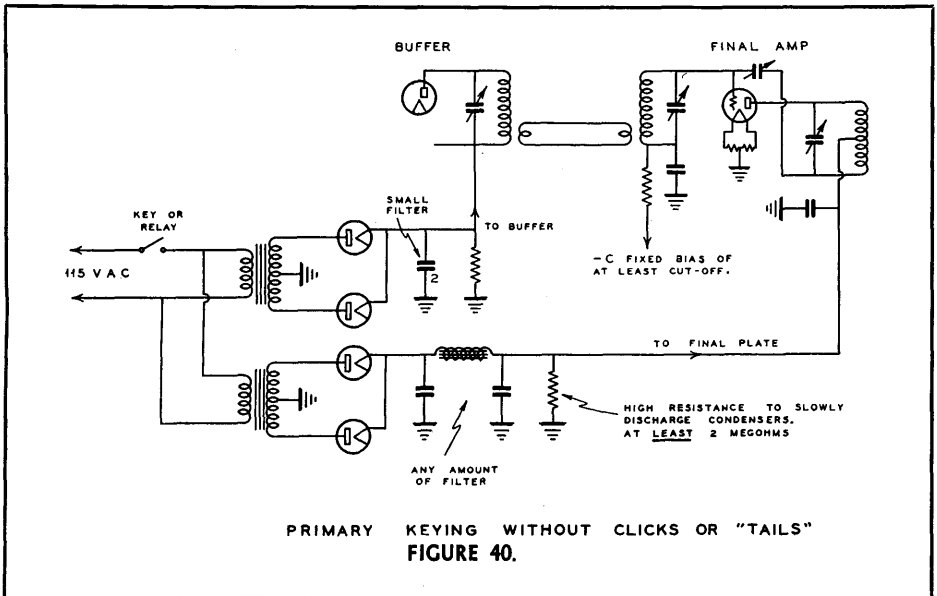

but must be insulated from ground for the high voltage.

At B is shown the simplest method not requiring batteries. If used as shown, the bias transformer must be insulated for the full plate voltage (secondary to both primary and case). Unfortunately, b.c.l. transformers were not designed to withstand 3,000 or 4,000 volts r.m.s., either between windings or to the case.

Blocked Grid Keying

The negative grid bias in a medium- or low-power r.f. amplifier can easily be increased in magnitude sufficiently to reduce the amplifier output to zero. The circuits shown in figures 42 and 43 represent two methods of such blocked grid keying.

In figure 42, R_1 is the usual grid leak. Additional fixed bias is applied through a 100,000-ohm resistor R_2 to block the grid current and reduce the output to zero. As a general rule, a small 300- to 400-volt power supply with the positive side connected to ground can be used for the additional C-bias supply.

The circuit of figure 43 can be applied

by connecting the key across a portion of the plate supply bleeder resistance. When the key is open, the high negative bias is applied to the grid of the tube, since the filament center tap is connected to a positive point on the bleeder resistor. Resistor R_2 is the normal bleeder; an additional resistor of from one-fourth to one-half the value of R_2 is connected in the circuit for R_1 . A disadvantage of this circuit is that one side of the key may be placed at a positive potential of several hundred volts above ground, with the attendant danger of shock to the operator. Blocked grid keying is not particularly effective for eliminating key clicks.

Oscillator Keying

A stable and quick-acting crystal oscillator may be keyed in the plate, cathode or screen-grid circuit for the purpose of minimizing key clicks and for break-in operation. This type of keying requires either fixed or cathode bias, since the r.f. excitation is removed from all of the grid circuits. The key clicks are minimized by the presence of several tuned circuits between the antenna and crystal

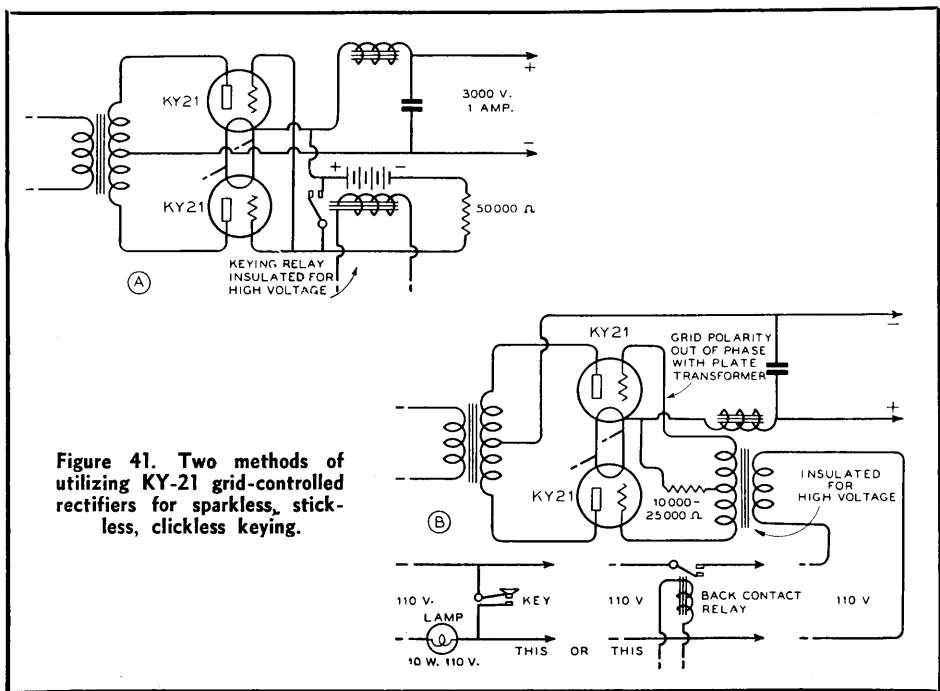

Figure 41. Two methods of utilizing KY-21 grid-controlled rectifiers for sparkless, stickless, clickless keying.

oscillator in a multistage transmitter. The key clicks act as sideband frequencies and are attenuated somewhat in a multistage transmitter by the resonant tuned circuits which are tuned to the carrier frequency.

If a key click filter is placed in the crystal oscillator circuit, the tone may become chirpy and tails may be added to the ends of the transmitted characters. A practical circuit for clickless keying is illustrated in figure 44, in which both the cathode of the crystal oscillator and the cathode of the next succeeding buffer or doubler circuit are connected through a key click filter.

Two tubes can be keyed very effectively with this type of circuit. The choke coil, shunted with a semivariable resistor, provides a series inductance for slowing down the application of cathode current to the two tubes. The inductance of the choke coil can effectively be lowered to one or two henrys by shunting it with a semivariable resistance so that the time-lag will not be excessive. The 0.5- μ fd. condenser and 400-ohm resistor are connected across the key contacts, as close to the key as possible, and these serve to absorb the spark at the telegraph key each time the circuit is opened. This effectively prevents a click at the end of each dot and dash. This same type of key click filter can be connected in the center-tap lead of a final amplifier or buffer-amplifier stage for the elimination of clicks.

Center-Tap Keying

The lead from the center-tap connection to the filament of an r.f. amplifier tube can be opened and closed for keying

a circuit. This opens the B-minus circuit, and at the same time opens the grid-bias return lead. For this reason the grid circuit is blocked at the same time that the plate circuit is opened, so that excessive sparking does not occur at the key contacts. Unfortunately, this method of keying applies the power too

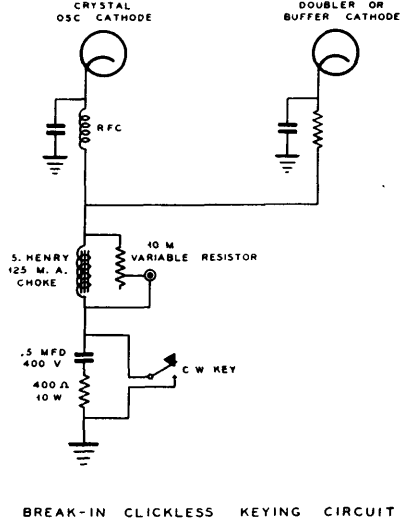

FIGURE 44.

suddenly to the tube, producing a serious key click in the output circuit, which generally is coupled to the antenna. This click often can be eliminated with the key click eliminator shown in figures 44 and 45.

Vacuum Tube Keying

Straight center-tap keying as shown in figure 46 never should be used, because this circuit produces extremely bad key clicks. The key click filter in figure 45 always can be connected into the center-tap lead as an external unit. A more effective key click filter for the center-tap lead is made possible through the use of vacuum tubes. A simple vacuum tube keying circuit is shown in figure 47.

The keying tube is connected in series with the center-tap lead of the final r.f. amplifier. The grid of the keying tube is short-circuited to the filament when the key is closed, and the keying tube then acts as a low resistance in the

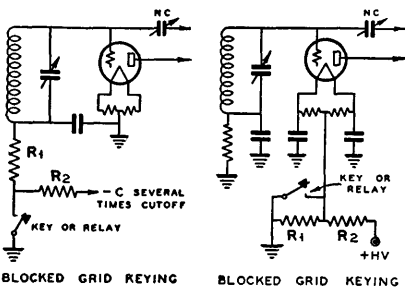
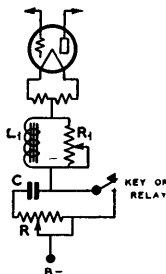

FIGURE 42.

FIGURE 43.

center-tap lead. When the key is opened, the grid of the keying tube tends to block itself and the plate-to-filament resistance

Figure 45. Center-tap keying with an adjustable key click filter. This system gives very good results. The actual amount of inductance and capacity in the circuit depends on the amount of current being keyed, and also on the voltage regulation of the plate power supply. L_1 should be of a value between 1 and 5 henrys; R_1 , 20,000 ohms; C , between $\frac{1}{4}$ and 2 μ fds.; R , 2,000 ohms.



of the tube increases to a high value, which reduces the output of the r.f. amplifier approximately to zero. A more effective vacuum tube keying system is shown in figure 48.

In this system, the grids of the keying tubes are biased to a high negative potential when the key is open and to zero potential when the key is closed. The fixed bias supply to the keying tubes provides very effective keying operation. The degree of time-lag (key click elimination) can be adjusted to suit the individual operator, by varying both the capacity of the condenser which is shunted from grid to filament, and the

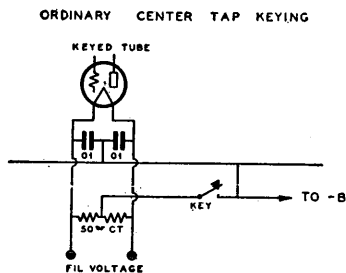

FIGURE 46.

Ordinary center-tap keying. The center tap of the filament transformer must not be grounded. As a general rule, the filament transformer which supplies the keyed stage will not be used to supply any of the other stages. The B-minus lead from the power supply should be grounded.

values of the two high resistances in series with the grid and power supply leads. R.f. chokes can be connected in series with the key directly at the key terminals, to prevent the minute spark at the key contacts from causing interference in nearby broadcast receivers. These r.f. chokes are of the conventional b.c. type. There is no danger of shock to the operator when this keying circuit is used.

The small power supply for this keying circuit requires very little filter and can be of the half-wave rectifier type with a '45 tube as the rectifier. The negative voltage from this power supply only needs to be sufficient to provide cut-off bias to the type 45 keying tubes; potentials of from 100 to 300 volts are needed for this purpose. Approximately 50 milliamperes of plate current in the final amplifier should be allowed per type 45 keying tube. If the final amplifier draws 150 milliamperes, for example, three type 45 keying tubes will be required.

A disadvantage of vacuum tube keying circuits is a plate supply potential loss of approximately 100 volts, which is consumed by the keying tubes. The plate supply therefore should be designed to

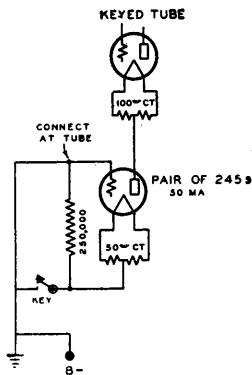

FIGURE 47.

Vacuum tube keying. The circuit shows one of the more simple vacuum tube keying circuits. Some current flows through the key and this system sometimes produces clicks when the key is opened. Both filament transformers must be insulated from each other and also from ground. This circuit will not completely cut off the plate current to the keyed stage, but will reduce it to a very small value.

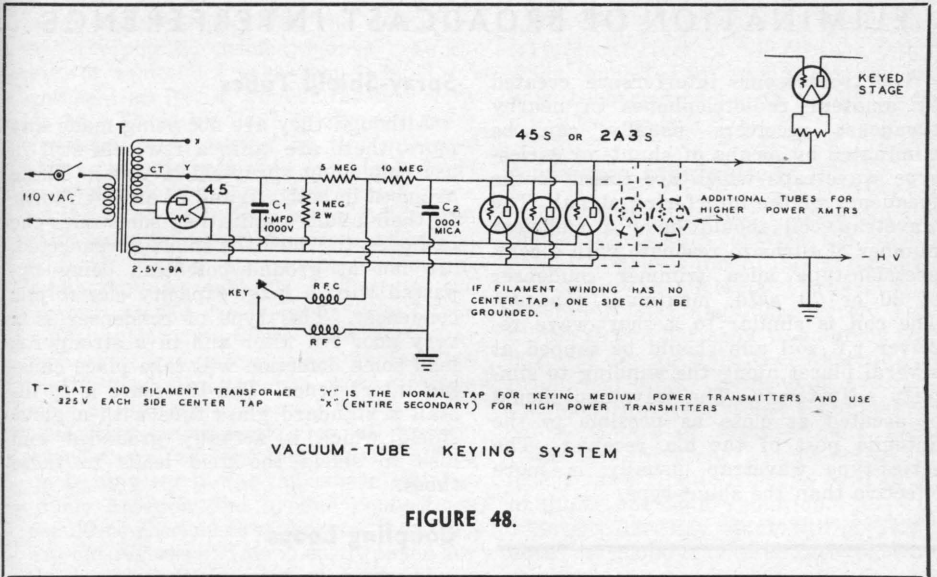
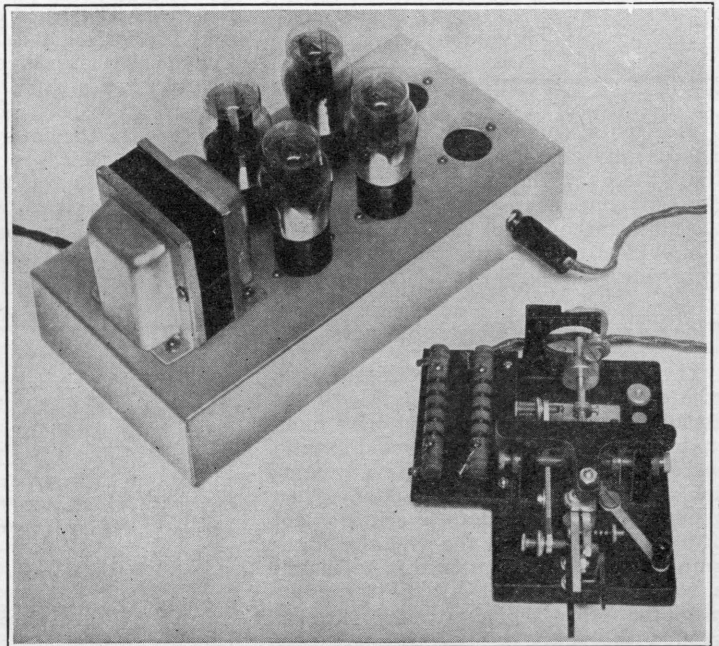

FIGURE 48.

give an output of 100 volts more than ordinarily is needed for the r.f. amplifier. This loss of plate voltage is encountered because the plate-to-filament resistance of the type 45 tubes, at 50

milliamperes of current and zero grid potential, is approximately 2000 ohms. This keying system is applicable for high-speed commercial transmitters, as well as for amateur use.

Figure 49. The vacuum tube keying system, using four 45's. Sockets for two additional (optional for higher power) tubes are provided. It is advantageous to mount the b.c. chokes directly at the key terminals, as shown.



ELIMINATION OF BROADCAST INTERFERENCE

The troublesome interference created by amateur radiotelephones in nearby broadcast receivers usually can be eliminated by means of shunt- or series-type wavetraps which are tuned to the frequency of the interfering signal. The wavetrap coil should have a sufficient number of turns to resonate with a compression-type mica trimmer condenser of 30 or 70 μmf . maximum capacity. The coil is similar to a short-wave receiver r.f. coil and should be tapped at several places along the winding to simplify adjustment. The wavetrap should be located as close as possible to the antenna post of the b.c. receiver. The series-type wavetrap usually is more effective than the shunt-type.

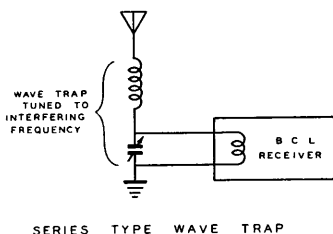

FIGURE 50.

Horizontal doublet transmitting antennas usually cause less local interference than those of the Marconi type. If a Marconi antenna is to be used, a counterpoise, rather than a ground connection, will often minimize the interference in broadcast receivers.

Floating Volume Control Shafts

Several sets have been encountered where there was only a slightly interfering signal; but, on placing one's hand up to the volume control, it would greatly increase. These proved to have volume controls with shafts insulated from ground and connected to a critical part of a circuit, especially the grid of a high-gain audio stage. The cure is to install a volume control with all the terminals insulated from the shaft, and then to ground the shaft.

Spray-Shield Tubes

Although they are not being made any more, there are quite a few sets still in use employing spray-shield tubes. These are used in both r.f. and in audio circuits. In their audio application, sometimes the cathodes, to which the shield is connected, are not at ground potential, being bypassed with a large-capacity electrolytic condenser. This type of condenser is a very poor r.f. filter and in a strong r.f. field some detection will take place causing interference. The best cure is to install a standard glass tube with a glove shield which is actually grounded and also to shield the grid leads to these tubes.

Coupling Loops

In order to increase the gain on the high-frequency end of the broadcast band, many sets use a loop of wire wound around the grid end of the input coil to provide some capacity coupling direct from the antenna to the grid. This, in conjunction with a high-impedance antenna primary, which is used to help the low-frequency end, allows the high-frequency signal to be passed directly to the grid. The basic cure is to move the coupling loop a little farther away from the end of the grid coil or to introduce a small capacity from antenna to ground. The use of a short receiving antenna will help reduce the interference. Especially avoid one which is any multiple of a half-wave long at the interfering frequency.

The antenna and ground system of the troubled b.c.l. set should be thoroughly checked for oxidized joints. There are so

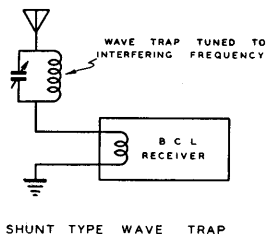

FIGURE 51.

many connections where the wires are not thoroughly cleaned before connecting, or sometimes even just twisted together, that it is a wonder the sets work at all. These oxidized joints can cause rectification, resulting in two or more strong signals mixing and riding in on each other or appearing at remote parts of the dial. Either copper oxide or iron rust has the properties of rectification, and the rectifier element can be in another wire or metallic system in the vicinity of the receiving antenna. Iron pipes rubbing against each other or against stucco screen, poor contacts in the lighting circuits, or in fact, any two metallic objects in partial contact with each other may cause a cross modulation which is re-radiated and can be picked up on any set in the immediate vicinity.

The antenna and ground connections should be checked to make sure that they are not reversed. This is easily taken for granted since the b.c. set will play, but a

set is very much more susceptible to interference from a short-wave station when connected up wrong. Several cases have been cleared up by simply correcting these leads.

Harmonic Elimination

The second harmonic of a 75-meter phone signal falls outside the amateur band and causes illegal interference with 37.5-meter commercial transmissions. Push-pull final amplifiers rarely cancel all the second harmonic in amateur transmitters, due to unbalanced circuits and insufficient tank circuit capacity to inductance ratio. Reference should be made to the *Chart of Tank Circuit Tuning Capacities* for proper circuit design. Sufficient tank circuit capacity will greatly minimize harmonic radiation.

Several circuits which will greatly reduce harmonic radiation are shown in chapter 4.

QUARTZ CRYSTALS

Quartz and tourmaline are minerals having a crystalline structure which, when cut and ground on certain crystallographic (optical) axes, possess piezoelectric properties in the influence of an oscillating electrical field. A detailed explanation of the piezoelectric effect will be found in any modern comprehensive encyclopedia.

The mechanical activity or frequency of a piezoelectric element depends upon its physical dimensions (the frequency being inversely proportional to the thickness). The stability of the oscillatory properties depends mainly upon the optical cut and the crystal-temperature coefficient.

A circuit containing a resonator (crystal) and possessing too little regeneration to oscillate itself, but which oscillates through the reaction of the crystal when the latter is vibrating near one of its normal frequencies with energy derived from the circuit, is called a *crystal controlled* or *piezo-oscillator*.

Crystal Cuts

The face of an X-cut or Y-cut crystal is made parallel to the Z axis in figure

52. Special-cut crystals, known as AT-cut, V-cut, LD2, HF2, etc., are made with the face of the crystal having an angle with respect to the Z axis, rather than being parallel to it. The purpose of these special-cut crystals is to increase their power handling ability in some cases, but especially to reduce the temperature coefficient. There is no frequency drift in crystals which have absolute zero temperature coefficient. AT, V, B5 and LD2-cut crystals have temperature coefficients approaching zero, and they should be used in radio transmitters in which accurate frequency control is essential, such as edge-of-band operation.

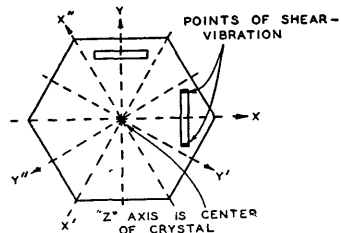

FIGURE 52.

These crystals eliminate the need of a crystal oven for amateur work. A constant operating temperature is still required for some commercial applications, but the oven temperature need not be kept within as close limits as for an X- or Y-cut plate.

Frequency Drift and Twin-Peaks

Crystals that oscillate at more than one frequency are commonly known as crystals with twin peaks. The dual vibrational tendency is more pronounced with Y cuts, but to a certain degree is exhibited by many X cuts. The use of a well-designed, space-wound, low-C tank coil in an oscillator will prohibit the crystal from oscillating at two frequencies, and in addition will increase the output. Experiments have shown that the frequency stability is not improved by large tank capacities, which only tend to augment the double frequency phenomenon.

Twin frequencies appear in several ways: sometimes the crystal will have two frequencies several hundred cycles apart, oscillating on both frequencies at the same time, and producing an acoustically audible beat note. Other crystals will suddenly jump frequency as the tank tuning condenser is varied past a certain setting. Operation with the tank condenser adjusted near the point where the frequency shifts is very unstable, the crystal sometimes going into oscillation on one frequency and sometimes on the other as the plate voltage is cut on and off. Still other crystals will jump frequency only when the temperature is varied over a certain range. And some plates will jump frequency with a change in either tank tuning or temperature, and produce an audible beat tone at the same time, showing actually two pairs of frequencies.

Use and Care of Crystals

When operating close to the edge of one band, it is advisable to make sure that the crystal will respond to but one frequency in the holder and oscillator in which it is functioning; a crystal with two peaks can jump frequency slightly without giving any indications of the change on the meter readings of the

transmitter. If the transmitter frequency is such that the operation takes place on the edge of the band at all times, under all conditions of room temperature, some form of temperature control will be required for the crystal unless it is of the zero drift type. When working close to the edges of the 14- or 28-megacycle band, it is essential that the crystal temperature be kept at a fairly constant value; the frequency shift in kilocycles per degree increases in direct proportion to the operating frequency, regardless of whether the fundamental or harmonic is used. When a crystal shifts its frequency by two kilocycles, its second harmonic has shifted 4 kilocycles. Amateurs not operating on the edge of the band generally need not concern themselves about frequency drift due to changes in room temperature.

If a pentode tube is used for the crystal oscillator having a plate potential of approximately 300 volts, the temperature of the crystal, regardless of cut, should not increase appreciably to cause any noticeable drift at even 14 megacycles. When a crystal oscillator is keyed on 3.5 or 1.7 megacycles, the frequency drift is not of any consequence, even with much higher values of plate input, because of the keying and of the fact that the drift is not multiplied as it would be with harmonic operation of a final amplifier.

Crystal holders have a large effect on the frequency; for example, the frequency of an 80-meter crystal can vary as much as 3 kilocycles in different holders. In fact, crystals can be purchased in variable gap holders which enable the operator to vary the frequency by varying the air gap. About 20- or 25-kc. shift can be obtained at 14 Mc. Only 40- and 80-meter AT-cut crystals are well-suited for this purpose.

High-Frequency Crystals

Forty-meter crystals can be treated much the same as 80-meter crystals, provided they are purchased in a dust-proof holder from a reliable manufacturer. However, it is a good idea with 40-meter crystals to make sure the crystal current is not excessive, as it will run higher in a given oscillator circuit than when a lower frequency crystal is used in the same circuit at the same voltage.

A low loss, low-C tank circuit and a pentode or beam type oscillator tube are desirable.

Twenty- and 10-meter crystals, especially the latter, require more care in regard to circuit details, components and physical layout. Ten-meter crystals are *not* of the zero drift type, as such crystals would be too thin to be of practical use. A special thick cut is used to give the crystal sufficient mechanical ruggedness. Crystals of this cut have a drift of approximately 40-45 cycles/Mc./deg. C. This means that such crystals must be run at very low power levels not only to avoid fracture, but to prevent excessive drift. However, their use permits considerable simplification of a u.h.f. transmitter.

A type 41 tube, running at 275 volts on the plate and 100 volts on the screen, makes a good oscillator tube for a 20-meter crystal. Bias should be obtained from a 500-ohm cathode resistor rather than a grid leak. Very light loading, preferably with inductive coupling, is required. The tank coil should be low loss, preferably air-supported or wound on a ceramic form.

Medium high- μ triodes with high transconductance and low input and output capacities make excellent 10-meter crystal oscillators. The types RK34, 6J5G and 955 are the most satisfactory oscillators, the 6J5G permitting the most output besides being the least expensive. The Jones regenerative oscillator circuit illustrated on page 299 is particularly well-suited to operation with 10-meter crystals.

Contrary to general practice with pentode crystal oscillators, the plate tank circuit should *not* be too low C; a moderate amount of tuning capacity should be used in a 10-meter triode crystal oscillator. The plate voltage on the oscillator tube should not be allowed to exceed 200 volts. About 2-watts output is obtainable from the 10-meter oscillator tank at this plate voltage. The tank coil can consist of 8 turns of no. 12 wire, air-wound and spaced the diameter of the wire, $\frac{3}{4}$ inches in diameter. Bias should be obtained

COIL WINDING TABLE FOR LOW-C WIRE-WOUND TANK COILS

BAND IN METERS	NO. 10 WIRE COILS	NO. 14 WIRE COILS	TOTAL COND. CAPAC. IN $\mu\mu$ FDS.
160	42 turns 5" diam. 6 turns per in.	38 turns 4" diam. 8 turns per in.	100
80	28 turns 4 $\frac{1}{2}$ " dia. 4 turns per in.	34 turns 2 $\frac{3}{4}$ " dia. 8 turns per in.	50
40	20 turns 3 $\frac{1}{2}$ " dia. 3 turns per in.	22 turns 2 $\frac{3}{4}$ " dia. 5 turns per in.	35
20	10 turns 3 $\frac{1}{4}$ " dia. 1 $\frac{1}{2}$ turns per in.	11 turns 2 $\frac{5}{8}$ " dia. 2 $\frac{1}{2}$ turns per in.	35
10	6 turns 2 $\frac{1}{2}$ " dia. 1 turn per in.	6 turns 2 $\frac{1}{4}$ " dia. 1 $\frac{1}{2}$ turns per in.	25

Note: These coils are suitable for plate-neutralized or push-pull amplifiers with low-C tubes. Grid-neutralized amplifiers require from 10% to 30% fewer turns than those listed above, depending upon the tube. Last column indicates smallest size tuning condenser usable.

from a 200-ohm cathode resistor (bypassed) and no grid leak. Connecting leads should be short and components small physically.

Both 10- and 20-meter crystal oscillators should be followed, where practicable, by a tube of high power gain, such as the 807. This cuts down the number of tubes required in a high-power stationary u.h.f. transmitter.

A 10-meter crystal oscillator with a 6J5G, driving a 6V6G doubler using a 150,000-ohm grid leak, makes an excellent 5-meter mobile transmitter. The latter tube can be either plate or plate-and-screen modulated. The modulation is better when doubling if both plate and screen are modulated.

CHAPTER 12

Exciter Construction

Frequency Control—High and Low-Powered Types—All-Band Operation—The Pierce Oscillator—Conversion Units.

VERY important to a radio transmitter is the means of controlling its frequency of operation. This *frequency* determines the place in the radio spectrum at which the transmitter operates. Some form of *oscillator* is needed for this purpose.

The most practical method of frequency control is by means of a quartz crystal oscillator, because the oscillation frequency is determined principally by the physical dimensions of the quartz plate. Quartz is a very hard substance which is not easily affected by temperature or pressure changes, and for this

reason the quartz crystal oscillator has a better frequency stability than most other forms of oscillators.

Relatively low-frequency crystal oscillators are often followed by *frequency doublers* or triplers, in order to obtain frequency control for high-frequency transmitters. That portion of the transmitter which supplies the actual control of frequency, in most cases, is defined as the *exciter*; therefore, the exciter includes the crystal oscillator and any frequency multipliers of medium- or low-power output.

CRYSTAL OSCILLATORS

Crystal oscillators can be divided into three classifications: (1) low-power circuits, which require several additional buffer stages to drive medium- or high-power final amplifiers; (2) high-power crystal oscillators, which minimize the number of buffer stages in a transmitter; (3) harmonic crystal oscillators, which operate on more than one harmonically-related band from one quartz crystal.

Low-power crystal oscillators are often required in transmitter design where extremely accurate frequency control is needed. The crystal oscillator tube is operated at low plate potential, such as 200 volts, with the result that oscillation is relatively weak. This means that there will be less heating effects in the quartz plate; the frequency drift, due to changes in temperature, is therefore minimized.

Mere operation of a quartz crystal oscillator tube at relatively low plate

voltage does not necessarily mean a low degree of frequency drift; a type of crystal oscillator tube must be used which has high power sensitivity, high μ and low feedback (interelectrode) capacity. The amount of feedback determines the value of r.f. current flowing through the quartz plate and thus determines the amplitude of the physical vibration of the quartz plate. Any tube which requires only a very small amount of grid excitation voltage and has low grid-to-plate capacity can be used to supply relatively high-power output in a crystal oscillator without heating of the quartz plate.

High-power crystal oscillators are those which operate with as high a plate voltage as can be used with only moderate heating of the quartz crystal. Many transmitters, such as those used for amateur work, do not require as high a

degree of frequency stability as for radiotelephone transmitters used for commercial services. The relatively high output from such crystal oscillators usually means the elimination of one or two buffer-amplifier stages. This simplifies the transmitter and may result in more trouble-free operation. There are a great many types of tubes suitable for high-power crystal oscillators, some of which are also used in high-stability low-power crystal oscillators by merely reducing the electrode voltages.

The crystal oscillator circuits in figures 1 and 2 are of the standard pentode-tube type. They operate on one frequency only, and the plate circuit is tuned to a frequency somewhat higher than that of the quartz crystal.

The actual power output of crystal oscillators, such as those shown in figures 1 and 2, is from one to five watts, depending upon the values of plate and screen voltage. The use of *AT-cut* or low temperature coefficient quartz plates allows higher values of output to be obtained without exceeding the safe r.f. crystal current ratings or encountering frequency drift. *X-cut* and *Y-cut* crystals, especially the latter, must be operated with comparatively low crystal current because they not only will not stand as much r.f. crystal current, but also have a higher temperature coefficient.

Push-Pull Crystal Oscillators

The type 53 twin-triode tube (2.5-volt heater) and its 6.3-volt companion tubes, 6A6 and 6N7, make good push-pull crystal oscillators. A typical twin-triode oscillator circuit is shown in figure 3.

Outputs of from 5 to 10 watts can be obtained from this circuit without exceeding the ratings of the usual *X-cut* crystals. The crystal current for a push-

pull oscillator is but little higher than for a single triode of the same type, and twice the output can be obtained.

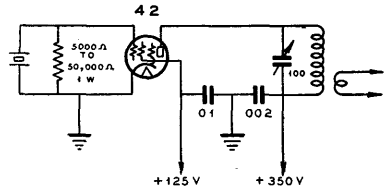

Figure 2. Pentode crystal oscillator with type '42 tube.

Oscillator-Doubler Circuit

The type 53 and 6A6 twin-triode tubes are popular for circuits where one triode acts as a crystal oscillator which drives the other triode as a frequency doubler; one tube, therefore, serves a dual purpose, supplying approximately 5 watts output on either the fundamental frequency or the second harmonic of the

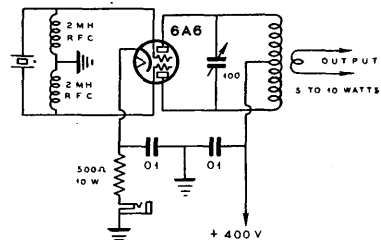

Figure 3. Dual-triode 6A6 (or 53) high-output push-pull oscillator.

quartz crystal. Two applications of the twin-triode tube in a crystal oscillator circuit are shown in figures 4 and 5.

Figure 4 is a circuit which can be used with quartz crystals cut for 160-, 80-, 40- or 20-meter operation. The circuit shown in figure 5 can be made regenerative in the frequency-multiplier section in order to use the second triode as a tripler or quadrupler. By reducing the capacity of the 25- μ fd. condenser (shown with an arrow pointing to it) to a low enough value, the second triode can be neutralized for use as a buffer stage. A suitable condenser for this purpose is a small mica-insulated trimmer condenser having a capacity range of from 3-to-30 μ fds.

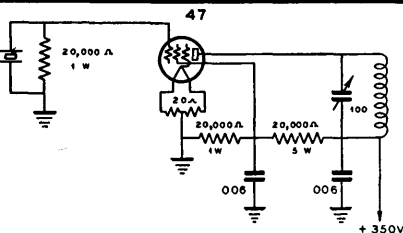

Figure 1. Pentode oscillator with type '47 tube.

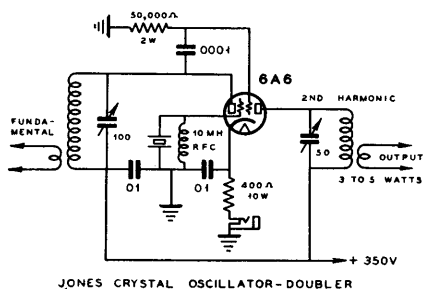

FIGURE 4.

The resistor R shown in figure 5 should be from 30,000 to 50,000 ohms in value, and generally the r.f. choke shown in series with this resistor can be omitted. Coil data for any of these exciters can be obtained from those circuits (shown in the following pages) for which constructional details are given.

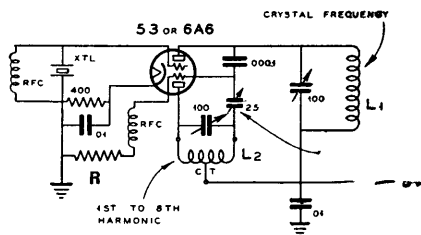

Figure 5. Regenerative exciter for all-band operation.

Pierce Crystal Oscillator

One of the earliest crystal oscillator circuits recently enjoyed a revival in popularity. This is the Pierce oscillator, in which the crystal is connected directly from plate to grid of the oscillator tube, the crystal taking the place of the tuned tank circuit in an ultra audion oscillator. Just as in the ultra audion, the amount of feedback depends upon the grid to cathode capacity. Thus, it is only necessary to connect from grid to cathode a fixed condenser permitting the proper amount of feedback for the tube and frequency band used. The capacity is not at all critical, and ordinarily it is not necessary to change the capacity even when changing bands.

The chief advantage of the oscillator is that it requires no tuned circuits. The chief disadvantage is that the maximum obtainable output is low, due to the fact that not over about 250 volts can be used safely. Also, it works well only with 160- and 80-meter crystals, though many 40-meter crystals will work satisfactorily if the constants are chosen for maximum performance on 40 meters.

The oscillator may be fed plate voltage either through an r.f. choke or a resistor of high enough resistance that it doesn't act as a low impedance path for the r.f. voltage. Such a resistor requires a much higher voltage plate supply for the same oscillator output than if an r.f. choke were used instead. The oscillator must of necessity be capacitively coupled to the following stage.

Several variations of the Pierce oscillator may be found in the multitube exciters described later in this chapter.

Tritet Crystal Oscillator

Any of the screen-grid tubes can be used in a tritet oscillator circuit such as the one shown in figure 6.

The tetrode or pentode plate circuit is electron coupled to the oscillator circuit. The plate circuit is generally tuned to the second harmonic and outputs of from 5 to 15 watts can be obtained without damage to the quartz crystal. This cir-

6L6G TRITET COIL DATA

WAVE-LENGTH	L2 PLATE COIL	L1 CATHODE COIL	CRYSTAL
160	78 turns #24 d.s.c. close-wound	Short-circuited	160
80	38 turns #18 enam. close-wound	25 turns #22 d.s.c. 1/2 in. long	160
40	20 turns #18 enam. 1/2 in. long	12 turns #18 enam. 1/2 in. long	80
20	9 turns #18 enam. 1/4 in. long	7 turns #18 enam. 1/4 in. long	40

All Coils Wound on 1 1/2-in. Diameter Forms.

cuit is an improvement over the older forms of tritet in which a grid leak was used in place of the grid r.f. choke, and in which no cathode resistor and by-pass condenser were included. The improved circuit (figure 6) decreases the crystal

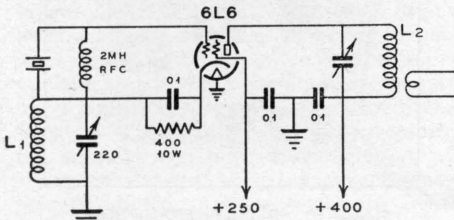

Figure 6. Tritet crystal oscillator.

current as much as 50 per cent, and thereby protects the crystal against fracture. The cathode circuit is high C and tuned to a frequency which is 40 per cent or 50 per cent higher than that of the crystal. If an 802 or 807 is substituted for the 6L6 tube, the plate circuit can be tuned to the fundamental frequency of the crystal without making it necessary to short-circuit the cathode tuned circuit.

Regenerative Oscillators

The simple regenerative circuit of figure 8, with a triode such as a 76, will deliver as much as 2 or 3 watts with an r.f. crystal current of between 10 and 60 ma. for crystals from 160 to 10 meters. The triode circuit is excellent to

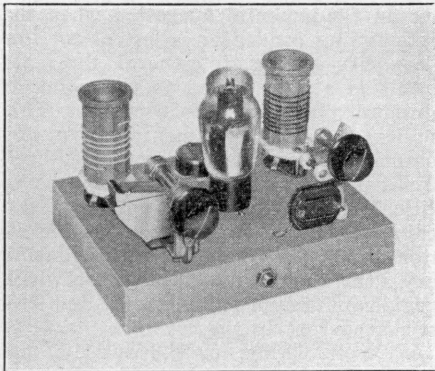

Figure 7. 6L6G tritet oscillator. For operation on fundamental frequency, the cathode coil is shorted-out.

drive a 6L6G buffer-doubler and the screen supply voltage for the 6L6G tube may be applied to the 76 plate circuit. This type of circuit is the only one which worked with all crystals, 10, 20, 40, 80 and 160 meters, whether they were extremely active such as a good X cut or relatively inactive sluggish type or high-frequency crystals. The triode will furnish from 1 to 2 watts at twice crystal frequency when used with 160-, 80- or 40-meter crystals by tuning the plate circuit to the second harmonic.

The circuit oscillates vigorously also with 10- and 20-meter crystals although harmonic operation is not possible with them. The latter varieties are generally cut to 30 or 60 meters and will operate on none but their odd harmonics. The regenerative cathode circuit in either figure 8 or 9 aids greatly in increasing the output from inactive crystals. The coil also reduces the r.f. current flowing through the crystal.

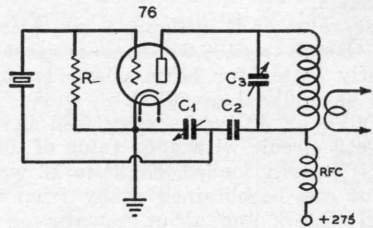

FIGURE 8. C₂—0.001-μfd. mica
R—50,000 ohms, 1 watt
C₁—100-μμfd. midget variable
C₃—50-μμfd. midget variable
RFC—2½-mh. r.f. choke

In figure 8, the cathode condenser C₁ is usually left at some setting of from 40 to 50 μμfd. for 40-, 80- and 160-meter crystals. A lower setting is desirable for 10- and 20-meter crystals. The .001-μfd. mica condenser merely isolates the d.c. plate voltage from the crystal and cathode by-pass condenser. The latter, C₁, provides an r.f. path from plate return to cathode and the reactance of this condenser is common to both grid and plate return circuits.

If more power output is required, an ordinary pentode, tetrode or beam tetrode tube can be substituted for the 76 triode. Very low crystal r.f. current flows with

any of these tubes, the maximum value being less than 100 ma. even for power outputs of 15 to 20 watts. Normally, r.f. grid currents of from 10 to 60 ma. were encountered with the circuit of figure 9. The main difference from figure 8 is in an extra tube element, the screen grid, which must be by-passed to the common ground bus. Since a higher gain tube is used, the condenser C_1 should be larger to provide less common reactance for the grid and plate circuit return leads to the cathode.

A fixed value of .00025 μ fd. is suitable for heavily loaded oscillator circuits where they are coupled to a high- μ triode such as a T20 or 809. For medium loading, C_1 should be made .0004 μ fd. to prevent self-excited oscillation. C_1 can be a .0005- μ fd. variable condenser if desired and its setting will provide convenient excitation control when the plate circuit is tuned to the second harmonic. Efficiencies of from 50 to 60 per cent are easily obtained in the plate circuit for either fundamental or second harmonic operation.

The value of R in figure 9 is not critical, though a 100,000-ohm resistor is slightly better for beam power tetrodes such as a 6V6G or 6L6G.

A 6F6 or 42 works very well in the figure 9 circuit with a C_1 value of .0001 μ fd. if heavily loaded. Eight to 12 watts output can be obtained easily from 160 to 20 meters and about 5 watts on 10 meters. A 6L6G tube requires a higher value of C_1 , about .0004 μ fd. unless heavily loaded. Outputs from 10 to 20 watts can be obtained without appreciable crys-

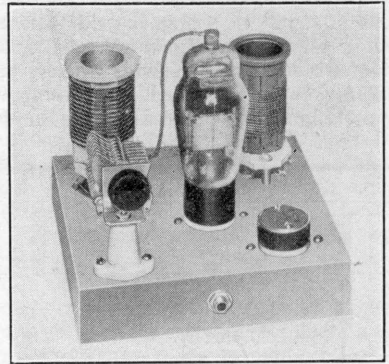

Figure 10. Reinartz 802 oscillator.

tal heating or drifting. A lightly loaded 6L6G may be too regenerative unless the condenser C_1 is as high as .0004 μ fd. The length of leads, type of construction and types of oscillator and buffer tubes determine the best value of C_1 and to some extent, R, in figure 9. The tetrode and pentode tubes are less critical than triodes as far as values of C are concerned, which means that small mica fixed condensers may generally be used in the circuit of figure 9. Several .0001- or .00025- μ fd. mica condensers can be connected in parallel for C_1 when testing the oscillator.

A single-spaced 50- μ fd. plate tuning condenser is satisfactory for the circuits of figures 8 and 9 unless the plate voltage exceeds 400 volts in figure 9. An 807 can be used to provide* over 30 watts output with a 600-volt plate supply with 160- and 80-meter crystals. At high plate voltage, the crystal current may be excessive on fundamental operation when the plate tuning condenser is left at too low a capacity setting. In general, the plate circuit is always tuned to the point of minimum plate or cathode current. This applies even to fundamental frequency operation since the common feed-back circuit prevents the oscillator from being critical in its tuning adjustments. An ordinary pentode or tetrode crystal oscillator circuit will usually stop oscillating very near the tuning adjustment which provides minimum plate current and lowest r.f. current in the crystal.

A 2-volt 60-ma. or 6.3-volt 150-ma. Mazda pilot lamp can be soldered in series with the tube grid lead to act as an indicator of r.f. current flowing through the crystal.

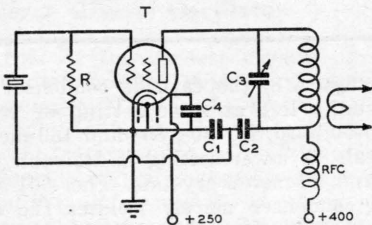

FIGURE 9.

- R—50,000 ohms (see text)
- C_1 —.0001 to .0004 μ fd. (see text)
- C_2 —.001- or .002- μ fd. mica
- C_3 —50- μ fd. midget variable
- C_4 —.01- μ fd. 600-volt tubular
- T—Any tetrode or pentode such as 6L6G, 42, etc.
- RFC—2½-mh. mid-get r.f. choke

Enough capacity should be used for C_1 , to cause the oscillator tube to stop oscillating abruptly when the plate tuning condenser is rotated to high capacity settings. Too small a capacity in C_1 will cause excessive crystal current with 40-, 20- and 10-meter crystals, and oftentimes self-excited oscillation. Too large a capacity in C_1 will result in low harmonic output when the tube is used as a doubler. When the correct value of C_1 is chosen for any particular transmitter design, no further changes are necessary when changing crystals providing the crystals are in good condition.

Several exciters utilizing this regenerative oscillator are described in detail farther along in this chapter.

Reinartz Crystal Oscillator

This regenerative crystal oscillator has a fixed-tune cathode circuit which is resonated to approximately *one-half* the crystal frequency. For example, with an 80-meter crystal the cathode circuit is tuned to 160 meters, the plate circuit to 80 meters. Either an 802 or a 6F6 tube can be used in a Reinartz crystal oscillator circuit. The output will be from 5 to 25 watts, depending upon the values of plate and screen voltages. The 6F6 is used as a high- μ triode in this same type of circuit, whereas the 802 is used as a pentode oscillator with additional control grid-to-plate capacity feedback. The circuit is shown in figure 11.

The crystal r.f. current is quite low in this circuit, in comparison with the output power which can be obtained. The cathode circuit is tuned to half the frequency of the crystal, and the reactive effect produces regeneration at the harmonic frequency. This increases the operating efficiency of the tube without dan-

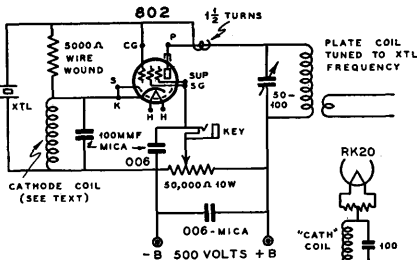

Figure 11. Reinartz 802 oscillator circuit.

REINARTZ OSCILLATOR COIL DATA

WAVE-LENGTH METERS	PLATE COIL	CATHODE COIL
160	70 turns #22 d.s.c. 2 in. long 1 3/4 in. diam.	116 turns #26 enam. close-wound 1 1/2 in. diam.
80	34 turns #18 enam. 2 in. long 1 3/4 in. diam.	55 turns #24 d.s.c. close-wound 1 1/2 in. diam.
40	16 turns #18 enam. 1 1/2 in. long 1 3/4 in. diam.	27 turns #24 d.s.c. 1 1/2 in. long 1 1/2 in. diam.
20	8 turns #18 enam. 1 1/2 in. long 1 3/4 in. diam.	14 turns #24 d.s.c. 1 1/2 in. long 1 1/2 in. diam.

ger of uncontrollable oscillation at frequencies other than that of the crystal.

6A6 Harmonic Oscillator

A type 6A6 or 53 twin-triode tube will supply output on either the fundamental or second harmonic of the crystal frequency in the circuit shown in figure 12.

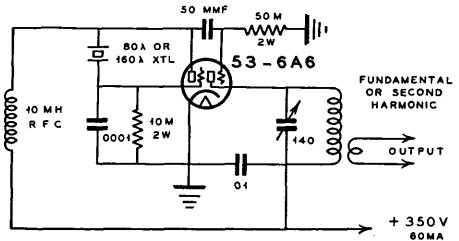

Figure 12. 6A6 harmonic oscillator.

One section of the 6A6 is used as a Pierce oscillator to drive the other triode of the 6A6. The circuit should be used only with 80- and 160-meter crystals. A .0001- μ fd. mica condenser is connected across the grid leak in order to obtain highest possible r.f. voltage at the plate of this triode section.

The grid of the second section of the tube is capacitively-coupled to the plate of the first section; the plate circuit of the second section is tuned to either the fundamental or second harmonic, depending upon whether fundamental or second harmonic output is desired. This oscillator circuit requires an active crystal and will not function satisfactorily

with 40- or 20-meter crystals. An output of approximately 7 watts can be obtained with an active 80- or 160-meter crystal. The r.f. choke is nonresonant, and should have an inductance of 6 to 10 millihenrys.

Crystal Oscillator Tuning Procedure

Every oscillator circuit is generally tuned for maximum output by means of an indicator of some form, such as d.c. milliammeter in the grid bias lead of the tube being driven by the oscillator. Maximum meter reading indicates maximum output from the crystal oscillator. Other indicators are: (1) A small neon bulb held near the plate end of the oscillator tuned circuit; maximum glow of the bulb indicates maximum oscillator output. (2) A flashlight bulb or a pilot light bulb, connected in series with a turn of wire, can be coupled to the oscillator coil for indicating r.f. output. Maximum brilliancy of the lamp denotes maximum output from the oscillator.

The type 53 or 6A6 oscillator-doubler circuit is adjusted by tuning the oscillator section for maximum output, and the doubler section for greatest dip in cathode or plate current. The crystal plate section should generally be tuned until the circuit approaches the point where oscillation is about to cease; this is towards the higher-capacity setting of the oscillator plate tuning condenser and operation in this manner provides most output in proportion to r.f. crystal current and frequency drift.

The cathode current should never exceed 75 milliamperes and safe limits for plate current in each section is 30 milliamperes. With cathode bias in this oscillator circuit, the plate current will drop to 20 or 30 milliamperes when the tube is not oscillating. The plate voltage for a 6A6 or 53 oscillator-doubler or push-pull oscillator may range from 250 to 400 volts, depending upon the power output which is needed.

Harmonic crystal oscillators are always tuned for maximum output and minimum plate, or cathode current. The regeneration or feedback condenser is adjusted or chosen to provide a good plate current dip when the plate circuit is tuned to the second harmonic of the crystal oscillator. Too much regeneration will cause the tube to oscillate for all settings of the plate tank condenser, without any sharp dip at the harmonic frequency of the crystal. Insufficient regeneration will result in low second harmonic output.

A plate potential of 400 volts is generally considered a safe upper limit for a type 6L6 oscillator tube. The screen-grid voltage affects the degree of regeneration and harmonic output; this voltage should generally range between 250 and 275 volts. The cathode current will run between 50 and 60 milliamperes for fundamental frequency operation, and 60 to 75 milliamperes for harmonic operation, at these plate and screen voltages. The crystal r.f. current normally runs between 25 and 75 milliamperes in this type of oscillator, depending on the frequency and plate voltage used.

Multi-tube Exciters

TWO-TUBE, TWO-BAND EXCITER WITH SINGLE TANK CIRCUIT

This simple exciter has but one tuned circuit, will cover two bands with one crystal on the lower frequencies. On the higher-frequency bands it works very well on the fundamental but not so well on the second harmonic.

The oscillator consists of a 6C5 in a Pierce circuit. The shell of the 6C5 should be grounded, and the tube and crystal sockets should be mounted above

the metal chassis. The crystal current will run between 50 and 100 ma., depending upon the frequency of the crystal, the plate voltage and the value of C_1 . Weak crystals, especially 40-meter crystals, may require as little as .0001 μ fd. at C_1 to maintain oscillation when the output circuit is tuned to the second harmonic. However, the .0002- μ fd. condenser specified in the diagram will do

Figure 13. This exciter delivers either fundamental or second harmonic output with 160-meter, 80-meter and most 40-meter crystals. It can also be used for fundamental operation with 20- and 10-meter crystals. Only one tank circuit is required.

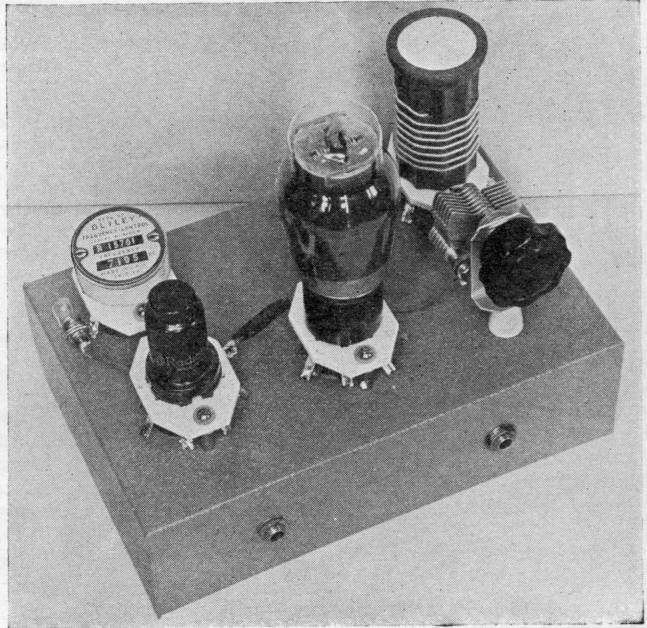

for most crystals and results in lower crystal current than a .0001- μ fd. condenser.

A 6.3-v. 150-ma. pilot lamp should be connected in series with the crystal by means of short leads, to indicate excessive crystal current. The bulb will glow dimly when the 6C5 is oscillating; if it glows brilliantly the crystal current is too high and the crystal is being endangered.

The output tank circuit is tuned for maximum output and minimum plate current, whether doubling or working straight through. No neutralization is

needed for working on the same frequency as the crystal; the 6L6G sort of "takes over" and acts somewhat as a regular 6L6G crystal oscillator.

The output will vary from 3 to 15 watts, depending upon the frequency of the crystal and the supply voltages. It is best to reduce the plate and screen voltages slightly from the indicated val-

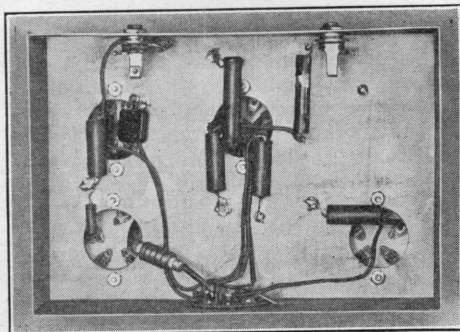

Figure 14. Bottom view of the "Boosted Pierce" exciter illustrated in figure 13 and diagrammed in figure 15.

COIL TABLE FOR BOOSTED PIERCE

BAND	6L6G COIL
160	65 turns
	#24 d.c.c. closewound 1 1/2 in. diam.
80	32 turns
	#20 d.c.c. closewound 1 1/2 in. diam.
40	17 turns
	#20 d.c.c. 1 1/2 in. long 1 1/2 in. diam.
20	9 turns
	#20 d.c.c. 1 1/2 in. long 1 1/2 in. diam.
10	4 turns
	#16 enam. 1 in. long 1 1/2 in. diam.

Reduce turns by 25 per cent with capacity coupling.

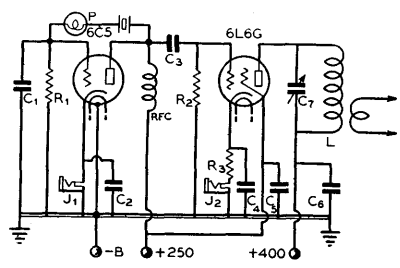

Figure 15. Wiring diagram of the "Boosted Pierce."

- C₁—.0002- μ fd. mica
- C₂—.01- μ fd. tubular
- C₃—.0001- μ fd. mica
- C₄—.01- μ fd. tubular
- C₅—.01- μ fd. tubular
- C₆—.01- μ fd. tubular
- C₇—100- μ fd. midget
- R₁—30,000-ohm carbon
- R₂—100,000-ohm 1 watt carbon
- R₃—300 ohms, 10 watts
- R₄—300 ohms, 10 watts
- R₅—300 ohms, 10 watts
- P—6.3-v. 150-ma. dial lamp
- RFC—2.5-mh. midget r.f. choke
- L—See coil table

ues when using a 10- or 20-meter crystal. The 6L6G may be either capacitively-coupled or link-coupled to the following stage. If capacitive coupling is used, the number of coil turns specified in the

table should be reduced by 25 per cent. With 10-, 20- and some 40-meter crystals, the coupling must not be too tight, loading the 6L6G too heavily, or the crystal may act sluggish or refuse to oscillate.

MULTIBAND 6L6 EXCITER USING REGENERATIVE OSCILLATOR

The exciter illustrated in figure 16 and shown schematically in figure 18 differs from the one just described in that it uses in place of the Pierce oscillator a regenerative oscillator having a tuned plate tank. The 6L6G stage is practically the same. The type of regenerative harmonic oscillator used in the exciter is

discussed in detail earlier in this chapter.

An output of between 10 and 15 watts is obtained on all bands from 10 to 160 meters at the supply voltages indicated. The 6L6G always operates as a doubler in this exciter except for 160-meter operation. On 160 meters the amplifier may be neutralized satisfactorily by link-coupling the two coils with a one-turn link in order to provide inductive neutralization. Correct polarity of the links and just the right amount of coupling must be used for good neutralization. Reversed polarity will make it impossible to secure complete neutralization by varying the coupling to one of the coils. Reverse or invert one of the link loops and try again. When the position and direction of the loops are correct, the output of the 6L6G will drop to zero when the crystal is removed. If the neutralization procedure is done with a crystal near the center of the 160-meter band, the neutralization will hold over most of the band.

The oscillator may be tuned either to the fundamental or second harmonic of the crystal frequency with all crystals except 10- or 20-m. crystals of HF cut.

76-6L6G EXCITER COIL DATA

BAND	COIL TURNS
160	60 turns #24 d.c.c. closewound 1 1/2 in. diam.
80	34 turns #20 d.c.c. closewound 1 1/2 in. diam.
40	17 turns #20 d.c.c. 1 1/2 in. long 1 1/2 in. diam.
20	8 turns #16 enam. 1 1/2 in. long 1 1/2 in. diam.
10	4 turns #16 enam. 1 in. long 1 1/2 in. diam.

Figure 16. This exciter uses a regenerative oscillator which is very stable and easy on crystals. The 6L6G output stage is used as a doubler on all bands except 160 meters; on the latter band, it is link-neutralized.

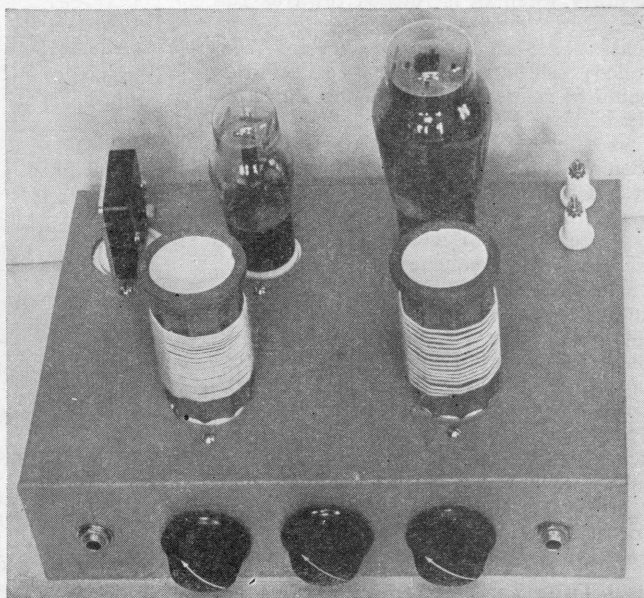

These can be used only on their fundamental. The 6L6G plate tank is always tuned to twice the frequency of the oscillator tank circuit except on 160 meters, as has already been mentioned.

The 76 will draw between 10- and 30-ma. plate current, depending upon the band and whether the plate is tuned to the fundamental or harmonic. The 100- μ fd. variable cathode condenser, which controls the regeneration, should ordinarily be set at about one-third to one-

half capacity. Less capacity increases the harmonic output slightly but with too little capacity the crystal current is higher, and the circuit becomes unstable and tends to oscillate independent of the crystal.

Both tank circuits should be tuned for maximum output and minimum plate current. The 6L6G cathode current will run from 40 to 80 ma. at the voltages specified, depending upon the load.

The 76 should go out of oscillation

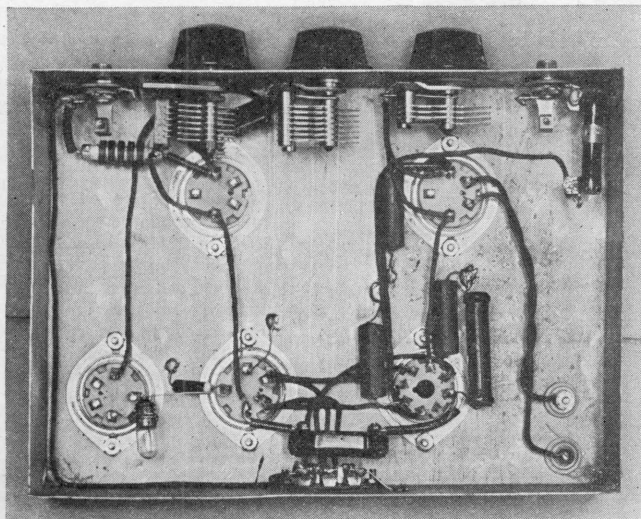

Figure 17. Under chassis view of the exciter illustrated in figure 16 and diagrammed schematically in figure 18.

abruptly when C_3 is rotated towards full maximum capacity. Failure to do so indicates self-excited (not crystal controlled) oscillation and the regeneration should be reduced by increasing the capacity of C_1 .

As the crystal current is quite low when the oscillator is operating normally, the pilot bulb in series with the crystal should not glow visibly with low-frequency crystals, or more than a very dull red with high-frequency crystals.

When using this exciter, it is important that one not attempt to crowd every last bit of harmonic output from the oscillator by running the regeneration condenser dangerously close to the self-oscillation point. The output is nearly as great when the capacity of C_1 is increased until the oscillator is entirely stable, showing no indication of instability regardless of the tuning of the oscillator tank condenser C_3 .

Two-Tube Self-Tuned Exciter

Pictured in figure 19 is an exciter similar to the one just described except that self-resonant coils are used, thus dispensing with tuning controls. Also, provision is made for switching to any of four crystals by means of a selector switch, making it unnecessary to plug crystals in and out of the circuit. The

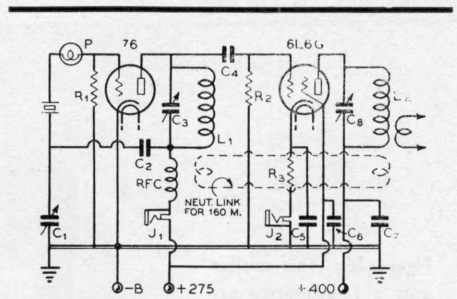

Figure 18. Wiring diagram of the 76-6L6G oscillator.

- | | |
|---|------------------------------------|
| C_1 —100- μ fd. midget variable | R_1 —50,000 ohms, 1-watt carbon |
| C_2 —0.01- μ fd. tubular | R_2 —100,000 ohms, 2-watt carbon |
| C_3 —50 μ fd. midget variable | R_3 —300 ohm, .10 watts |
| C_4 —100- μ fd. mica | P—6.3-v. 150-ma. dial lamp |
| C_5, C_6, C_7 —.01- μ fd. tubular | L_1, L_2 —See coil table |
| C_8 —50- μ fd. midget | |

output of the exciter is a little less than for the exciter just described in which the coils are tuned to exact resonance for each crystal by means of condensers, being about 5 watts on 10 meters and about 10 watts on lower frequency bands.

The exciter is not particularly well adapted for use on 160 meters, as the

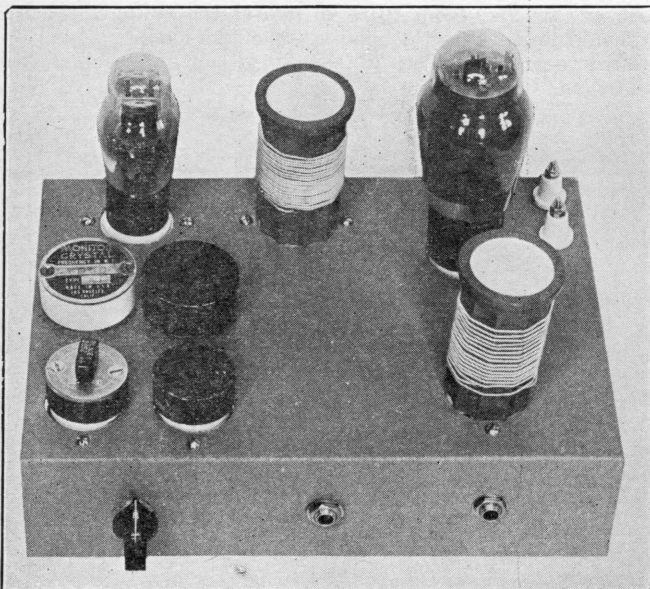

Figure 19. No tank tuning condensers are used in this 5-10-watt exciter. The coils are pruned and the wire spacing adjusted until the circuits are self-resonant. The knob on the front of the chassis works the crystal selector switch.

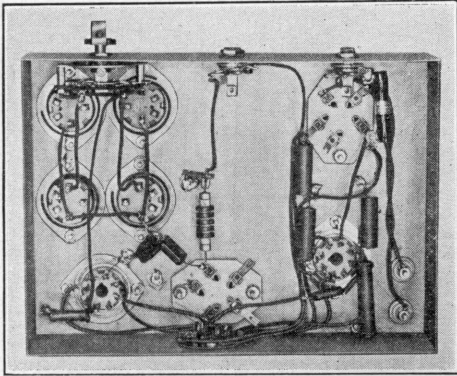

Figure 20. Bottom view of the two-tube self-tuned exciter. Note absence of tuning condensers.

link neutralizing scheme used in the previous exciter for straight-through operation on 160 meters is not especially satisfactory when self-resonant coils are used. The 6L6G should always be operated as a doubler and, while the oscillator can be used on the second harmonic, it works somewhat better on the fundamental when self-tuned coils are used.

Except for the lack of a variable regeneration condenser and plate tuning condenser, the regenerative oscillator is similar to that used in the exciter previously described. The 6L6G doubler is also the same except for the use of un-tuned plate coils.

The coils should be wound according to the coil table and then, using crystals that hit the approximate center of the various bands, the spacing of the turns should be varied by squeezing the windings together or apart until maximum output is obtained. The turns should then be cemented to the form to hold them in place. Capacity coupling between the exciter and the next tube cannot be used, as it will upset resonance of the 6L6G plate coil. A two-turn loop and coupling link can be used to couple the exciter. The link coupling loop should be placed at the cold end of L_2 in order

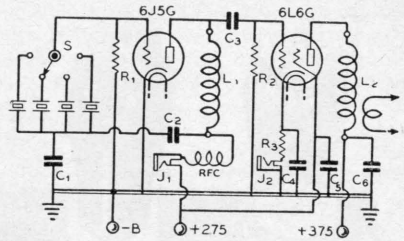

Figure 21. Wiring diagram of the two-tube self-tuned exciter.

- C_1 —0.002- μ fd. mica
- C_2 —0.01- μ fd. mica
- C_3 —0.01- μ fd. mica
- C_4, C_5, C_6 —0.1- μ fd. tubular
- R_1 —50,000 ohms, carbon 1 watt
- R_2 —100,000 ohms
- R_3 —500 ohms, 10 watts
- RFC—Midget 2.5-mh r.f. choke
- S—Single-pole selector switch
- L_1, L_2 —See coil table

to avoid detuning effects as a result of capacity coupling.

Deviations from the physical layout illustrated in figures 19 and 20 may make slight alterations in the number of coil turns necessary.

COIL DATA FOR 6J5G-6L6G EXCITER

BAND	6J5G OSCIL-LATOR	6L6G DOUBLER
160	100 turns #28 d.s.c. 1 1/2" diam. 2" long	
80	50 turns #22 d.c.c. 1 1/2" diam. 2 1/4" long	68 turns #24 d.c.c. 1 1/2" diam. 2" long
40	22 turns #22 d.c.c. 1 1/2" diam. 1 1/4" long	30 turns #22 d.c.c. 1 1/2" diam. 1 1/2" long
20	12 turns #20 d.c.c. 1 1/2" diam. 1 1/2" long	14 turns #20 d.c.c. 1 1/2" diam. 1 1/8" long
10		6 1/2 turns #18 enam. 1 1/2" diam. 1" long

THREE-TUBE SELF-TUNED EXCITER

While the 20-160 meter self-tuned exciter illustrated in figure 22 and diagrammed in figure 24 has one more tube than the self-tuned exciter just described,

it has only one coil instead of two and can be used on 160 meters. The 6L6G output stage is identical, but because no resonant circuits are used ahead of it,

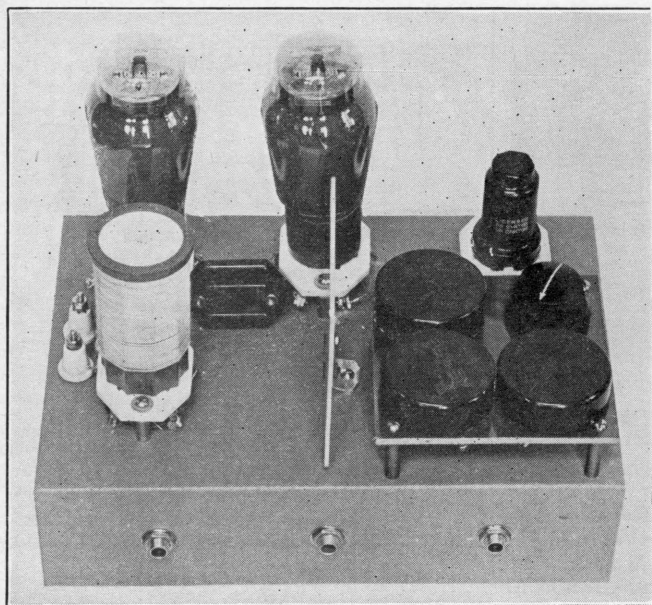

Figure 22. With no tuning condensers and only one set of coils, this exciter covers three bands with either an 80-meter or a 160-meter crystal. Five to ten watts output is obtainable on any band from 20 to 160 meters.

the exciter can be used to deliver output on the crystal frequency if desired. Output on one, two or four times the crystal frequency is obtainable by merely selecting the proper untuned plate coil for the output stage. The power output ranges between 5 and 10 watts, being somewhat greater when working straight through than when quadrupling. The output can be increased nearly 50 per cent by cutting down on the number of coil turns slightly and resonating the circuit by means of a midjet variable

condenser. However, most amateurs will be willing to sacrifice a small amount of output in order to enjoy the advantages of having no tuning control.

Because the Pierce oscillator used works well only with 80- and 160-meter crystals, the exciter cannot be used for 10-meter output.

It is important that the r.f. chokes in the grid and plate circuits of the untuned 6L6 buffer-doubler be sufficiently dissimilar that a low-frequency parasitic does not occur. It should be noted that

COIL DATA FOR 3-TUBE SELF-TUNED EXCITER

BAND	APPROX. COIL DIMENSIONS
160	130 turns closewound #28 enam. 1½" diam.
80	68 turns #26 d.c.c. 1½" diam. 2" long
40	30 turns #22 d.c.c. 1½" diam. 1½" long
20	14 turns #22 d.c.c. 1½" diam. 1⅛" long

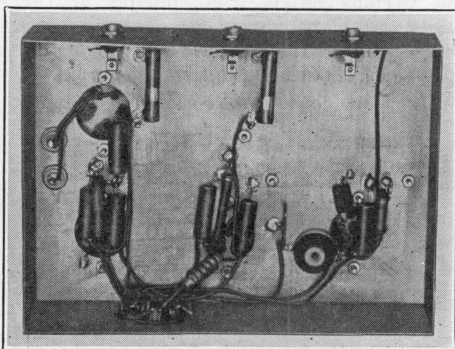

Figure 23. Under chassis view of the three-tube self-tuned exciter. Note the dissimilar r.f. chokes; one has considerably more inductance than the other to avoid parasitic oscillations.

the first 6L6G is *untuned* and not *self-tuned*.

The coils should be wound according to the coil table and then the turns squeezed together and apart until maximum output is obtained at the center of

each band. The turns should then be cemented in place. The 20- and 40-meter coils should have a 1-turn coupling turn at the cold end for link coupling. The 80- and 160-meter coils should have 2 turns similarly placed.

FIGURE 24. SCHEMATIC DIAGRAM OF THE THREE-TUBE SELF-TUNED EXCITER.

- | | |
|--|---|
| C ₁ —0.001- or .0002-
μfd. mica | R ₅ —300 ohms, 10
watts |
| C ₂ —0.01-μfd. tubular | R ₄ —100,000 ohms, 2
watts |
| C ₃ —0.001-μfd. tubular | R ₃ —300 ohms, 10
watts |
| C ₄ —0.01-μfd. tubular | R ₂ —300 ohms, 10
watts |
| C ₅ —0.01-μfd. tubular | S—Double - pole,
triple-throw selec-
tor switch |
| C ₆ —0.00025-μfd. mica | RFC ₁ —8-mh. r.f.
choke |
| C ₇ , C ₈ , C ₉ —0.01-μfd.
tubular | RFC ₂ —2.5-mh. r.f.
choke |
| R ₁ —50,000 ohms, 1
watt | L—See coil table |
| R ₂ —100,000 ohms, 1
watt | |

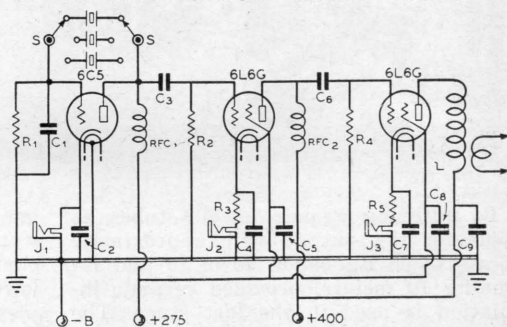

THE DYNAPUSH EXCITER

This popular exciter, first described in RADIO, will deliver approximately 25 watts at the crystal frequency, and about 20 watts from the doubler stages except on 10 meters. On 10 meters, the output falls off to about 12-14 watts.

By substituting an isolantite base

6L6G (RK-49) in the last stage, along with an isolantite insulated midget condenser and a ceramic coil form for the 10-meter coil, the output on 10 meters will compare more favorably with that obtainable from the doublers on lower frequencies.

Figure 25. The popular "Dyna-push" exciter. To change bands, one merely throws the band-switch and places the coupling link over the corresponding coil. No retuning is required.

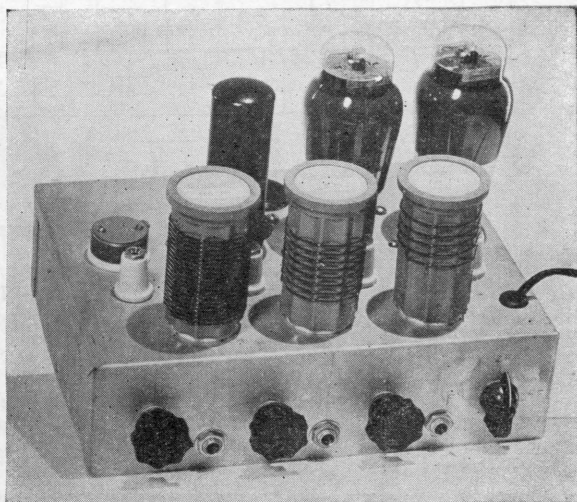

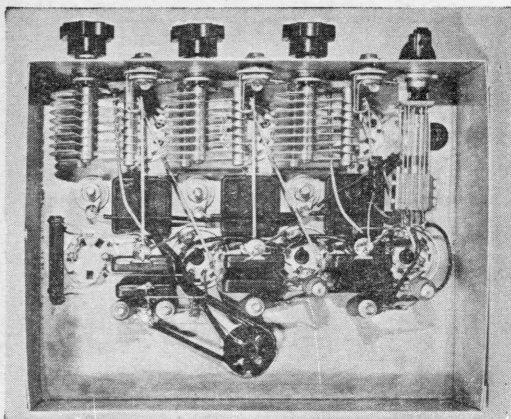

Figure 26. Under chassis view of the "Dynapush" exciter.

By utilizing a pair of 809 tubes as doublers, the output will approximate 25 watts on all bands down to and including 10 meters, provided ceramic insulation is used in the last stage. The only change in constants required for 809's is the substitution of a 10,000-ohm resistor for the 5000-ohm one at R_5 . It is also preferable to use a higher range tuning milliammeter, though not absolutely necessary.

This oscillator either drives the follow-

ing stage or delivers approximately 25 watts, with only about 65 ma. of crystal current for a 40-meter crystal (less for lower frequencies). With the load completely removed (no external load and the grid of the following stage open), the crystal current is somewhat higher, but not dangerously so.

Only five coils are required to cover all bands from 10 to 160 meters, one coil for each band to be covered. The coils are easily constructed, as there are no

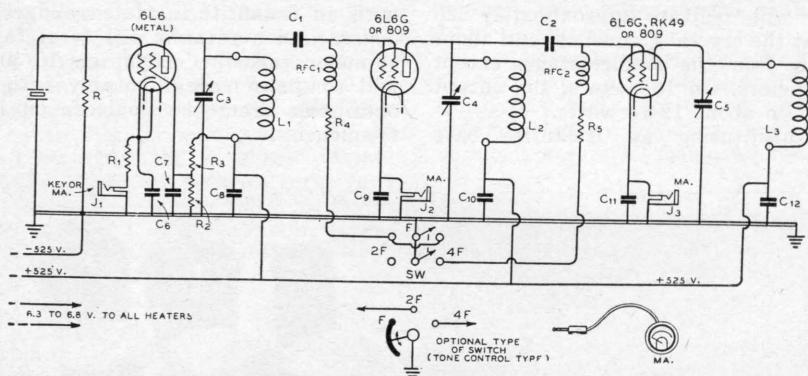

FIGURE 27. GENERAL WIRING DIAGRAM OF THE "DYNAPUSH"

C_1 —100- μ fd. mica	watts	used)	milliammeter (0-
C_2 —.006- μ fd. mica	R_2 —20,000 ohms, 10	SW—D.P.D.T. switch	200 if 809's are
C_3, C_4, C_5 —50 μ fd.	watts	with "center-off"	used)
double - spaced	R_3 —15,000 ohms, 10	position, or a	RFC_1 —2.5- mh. r.f.
midgets	watts	three - position	choke (8 mh. if
C_6 to C_{12} —.006- μ fd.	R_4 —10,000 ohms, 10	"tone control"	160-meter crystal
mica	watts	switch (see text)	is to be used)
R —50,000 - ohm 1-	R_5 —5000 ohms, 10	J_1, J_2, J_3 —Closed circuit	RFC_2 —2.5 - mh. r.f.
watt carbon	watts (10,000	jacks	choke
R_1 —300 ohms, 10	ohms if 809's are	MA—O-150 ma. d.c.	

taps or jumper connections to make. The approximate number of turns for each band is given in the coil table. Some alteration may be required in each particular instance to get some of the coils to work both in the oscillator and doubler positions with the tuning condensers specified.

The chief attributes of this exciter are its freedom from bugs, such as parasitics and self-oscillation, and the fact that the arrangement of parts is not at all critical as in some exciters.

The exciter is coupled to the next stage by means of link coupling. The coupling loop is placed over the corresponding exciter coil and the bandswitch thrown to the corresponding position. In other words, for fundamental operation the link is coupled to the oscillator coil; for second harmonic operation the link is coupled to the first doubler coil, and so forth.

The power supply should deliver from 500 to 550 volts under load and possess *good regulation*. For 6L6G doublers, it should have a capacity of at least 200 ma., and for 809's a capacity of 250 ma.

PUSH-PUSH 6L6G EXCITER

Two 6L6G's can be connected in push-push to make an excellent doubler down to 30 Mc., and a fair doubler on 56 Mc. About twice the output of a single tube doubler is obtained with the push-push arrangement, or about 25 to 30 watts on lower frequencies and 15 to 20 watts on 28 Mc. at normal plate voltage.

A 6J5G high- μ triode crystal oscillator using cathode bias to lower the crystal current drives a 6L6G neutralized buffer, doubler or quadrupler, which in turn drives the push-push doubler stage on any frequency from 80 down to 5 meters. When 160-meter excitation is desired, the first 6L6G can be operated as a straight buffer on 160 meters and the coupling link coupled to the buffer tank instead of to the push-push doubler tank. A switch is provided in the push-push doubler cathode lead to cut out that stage when 160-meter output is desired. About 20 to 25 watts of 160-meter excitation is available from the single 6L6G operating as a neutralized amplifier.

DYNAPUSH COIL TABLE

	160 METERS
70 t. 1 1/2" diam., #22 enam. closewound	
	80 METERS
34 t. 1 1/2" diam., #22 d.c.c. closewound	
	40 METERS
20 t. 1 1/2" diam., #18 enam. spaced 2"	
	20 METERS
9 t. 1 1/2" diam., #18 enam. spaced 1 1/2"	
	10 METERS
4 1/2 t. 1 1/2" diam., spaced 1 1/4" or	
6 t. 1 1/4" diam., spaced 1 1/2" #18 enam.	

The exciter may be keyed in any one of the three cathode jacks. For break-in operation, the key would obviously be inserted in the oscillator jack. Keying of the oscillator is very clean and free of "yoops."

If the exciter is to be used with a 160-meter crystal, RFC, should be made about 8 mh. instead of 2.5 mh., as the latter does not offer sufficiently high impedance at 160 meters.

The 6J5G-6L6G combination is a better frequency multiplier than the popular 6A6 oscillator-doubler arrangement, more output is obtained on both fundamental and second harmonic and the output is quite respectable even when quadrupling. This permits operation of the push-push doubler on two, four or eight times the crystal frequency and provides fundamental frequency output from the buffer stage as explained above.

Construction

The model illustrated in figure 28 is constructed in a standard relay rack unit. The 6J5G oscillator tuning condenser is mounted below the chassis with only a knob control on the front panel; an indicator dial is not required because the exact setting is not critical so long as the crystal is oscillating.

The 6L6G buffer is neutralized by means of a 3-30 μ fd. ceramic insulated mica trimmer condenser. The adjusting screw is removed and the top plate bent

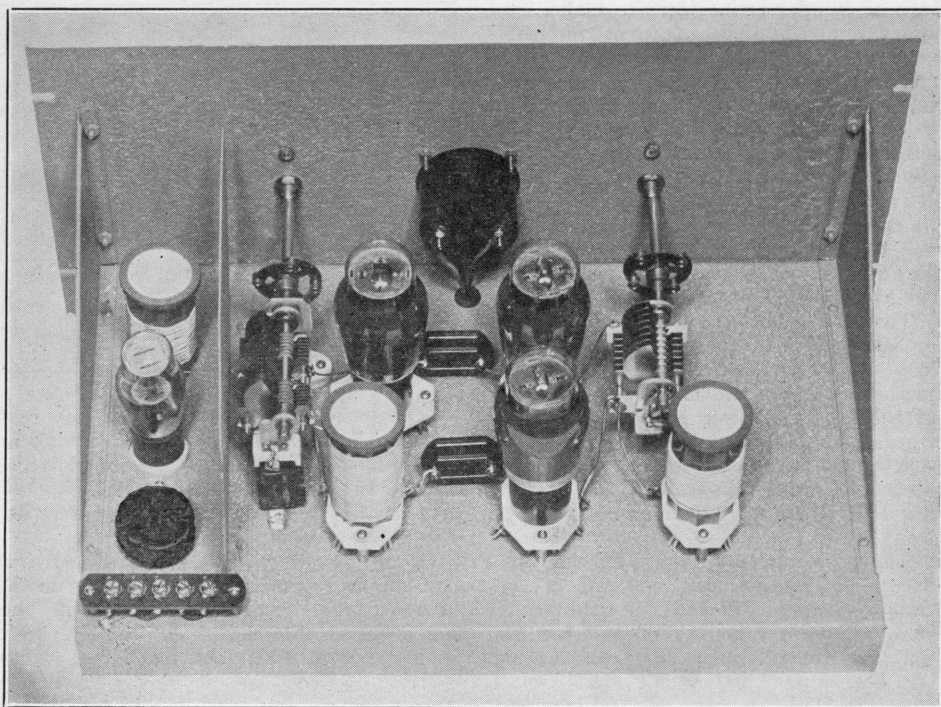

FIGURE 28. THIS EXCITER USES A PAIR OF PUSH-PUSH 6L6G'S IN THE OUTPUT STAGE TO DELIVER 25 TO 30 WATTS ON 80, 40 AND 20 METERS, 15 TO 20 WATTS ON 10 METERS AND ABOUT 5 WATTS ON 5 METERS.

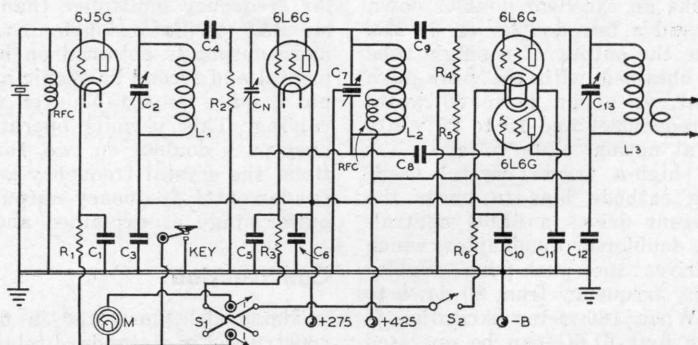

FIGURE 29. WIRING DIAGRAM OF THE PUSH-PUSH 6L6G EXCITER.

C_1 —.01- μ fd. tubular	C_7 —100- μ fd. per section midget	variable	R_4, R_5 —100,000 ohms, 3 watt carbon
C_2 —50- μ fd. midget variable	C_8, C_9 —50- μ fd. mica	R_1 —300 ohms, 10 watts	R_6 —150 ohms, 10 watts
C_3 —.01- μ fd. tubular.	C_{10}, C_{11}, C_{12} —.01- μ fd. tubular	R_2 —250,000 ohms, 2 watts	RFC—2.5- to 8-mh. r.f. choke
C_4 —50- μ fd. mica	C_{13} —50- μ fd. midget	R_3 —300 ohms, 10 watts	M—0-200-ma. d.c.
C_5, C_6 —.01- μ fd. tubular			

in and out until the stage operates stably as a neutralized buffer; the spacing will usually be about one-eighth inch.

This exciter is somewhat of an improvement upon and preferable to the widely popular "Bi-Push" exciter first described in April, 1937, in RADIO. A larger complement of coils is required,

but the advantages offered by the exciter illustrated make the extra coils very much worth while.

To avoid possible parasitic oscillation in the buffer stage, the buffer coils should be trimmed if necessary until the condenser C_1 always resonates with the plates at least half-way meshed.

COIL DATA FOR PUSH-PUSH 6L6G EXCITER

BAND	6J5G OSCILLATOR	6L6G PLATE	PUSH-PUSH 6L6G
160	70 turns #24 d.c.c. closewound 1 1/2" diam.	68 turns #22 d.c.c. 2 1/4" diam. 2 3/4" long c.t.	
80	36 turns #24 d.c.c. 1 1/2" diam. 1 1/2" long	38 turns #20 d.c.c. 1 1/2" diam. 1 1/2" long c.t.	36 turns #20 d.c.c. 1 1/2" diam. 1 3/4" long
40	17 turns #22 d.c.c. 1 1/2" diam. 1 1/2" long	20 turns #16 enam. 1 1/2" diam. 1 1/2" long c.t.	16 turns #16 enam. 1 1/2" diam. 1 3/8" long
20	7 turns #16 enam. 1 1/2" diam. 1 1/4" long	10 turns #16 enam. 1 1/2" diam. 1 1/4" long c.t.	8 turns #16 enam. 1 1/2" diam. 1" long
10		4 turns #16 enam. 1 1/2" diam. 1" long c.t.	4 turns #16 enam. 1 1/2" diam. 1" long
5			2 turns #14 1/2" diam. spaced 2 diam. of wire

6L6G-809 EXCITER, 10-160 METERS

Probably the most practical exciter where 30 to 50 watts output is required is the 6L6G-809 combination illustrated in figures 30 and 31 and diagrammed schematically in figure 32. The only disadvantage as compared to the exciters previously described is the necessity for slightly more plate voltage, which should be at least 600 volts for good output. The exciter can also be used to feed an antenna directly, making an excellent low-power transmitter.

A regenerative 6L6G oscillator of the type previously discussed delivers output on either the fundamental or second harmonic of the crystal when crystals of the usual type are employed. High-frequency

crystals of the harmonic cut type (this includes all 10-meter crystals and certain 20-meter crystals) will work only on the frequency marked on the crystal holder. As there is no reason for doubling in the oscillator except with low-frequency crystals, this is no handicap.

The amount of regeneration in the oscillator is determined by the capacity of C_1 . Too much regeneration (too little capacity) will result in excessive crystal current and possibly self-oscillation not controlled by the crystal. Too little regeneration (too much capacity) will result in low second harmonic output, especially with 40-meter crystals. The optimum value will depend somewhat upon

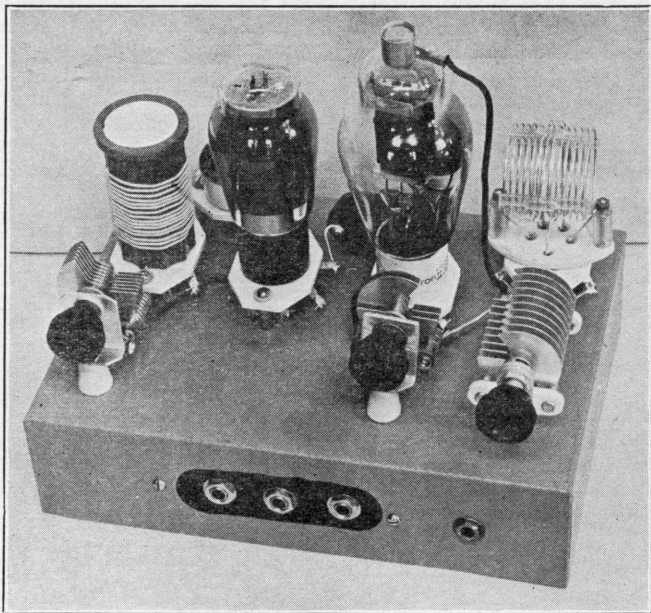

Figure 30. Delivering from 30 to 50 watts on all bands from 10 to 160 meters on one, two or four times crystal frequency, this exciter can also be used as a low-power transmitter to feed directly into an antenna.

the physical layout of the parts, and will be between .00025 and .0005 μ fd. A value of .0004 μ fd. will ordinarily be found satisfactory. There is no need to change the value of this condenser once the correct size for the particular layout

and driven tube is determined, and for that reason a mica condenser is employed. When determining the best value experimentally, it is advisable to do it with a 40-meter crystal in the circuit.

The 809 stage is neutralized and therefore can be used either as a straight amplifier or as a doubler. The output when doubling is practically as great as when working straight through, but the

COIL DATA FOR 6L6G-809 EXCITER

BAND	6L6G	809
160	60 turns #24 d.c.c. closewound 1½" diam.	68 turns #20 d.c.c. closewound 2¼" diam. c.t.
80	30 turns #20 d.c.c. closewound 1½" diam.	44 turns #20 d.c.c. 1½" diam. 2" long c.t.
40	16 turns #20 d.c.c. 1½" diam. 1½" long	20 turns #20 1¾" diam. 1½" long c.t.
20	8 turns #20 d.c.c. 1½" diam. 1½" long	12 turns #20 1¾" diam. 1½" long c.t.
10		6 turns #16 enam. 1½" diam. 1½" long

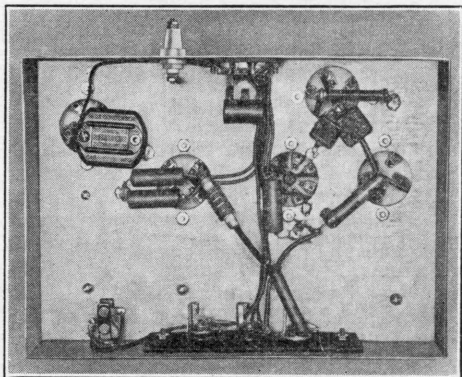

Figure 31. Underneath the 6L6G-809 exciter chassis.

plate current runs a little higher. The coils should be accurately center-tapped if the neutralization adjustment is to hold when changing coils. If this is done carefully, the neutralization will hold sufficiently on all lower frequency bands after the stage is neutralized with the 20-meter coil in the circuit. It is advisable to use the 809 as a doubler to

10 meters, though it can be used as a straight amplifier on that frequency if sufficient care is taken.

The plate current to the 6L6G under operating conditions should run about 50 ma., the 809 grid current between 20 and 30 ma. under load, and the 809 plate current can be anything up to 100 ma. so long as the tube shows no color.

FIGURE 32. SCHEMATIC DIAGRAM OF THE 6L6G-809 EXCITER OR TRANSMITTER.

- | | |
|---|---|
| C ₁ —0.004- μ fd. mica (critical) | R ₁ —100,000 ohms, 2 watts |
| C ₂ —0.02- μ fd. mica | R ₂ —10,000 ohms, 10 watts |
| C ₃ —0.1- μ fd. tubular | R ₃ —5000 ohms, 10 watts |
| C ₄ —100- μ fd. midget variable | R ₄ —100-ohm 10-watt c.t. resistor |
| C ₅ —0.01- μ fd. mica | RFC—2.5-mh. midget r.f. choke |
| C ₆ , C ₇ —0.1- μ fd. tubular | L ₁ , L ₂ —See coil table |
| C ₈ —50- μ fd. double-spaced midget | |

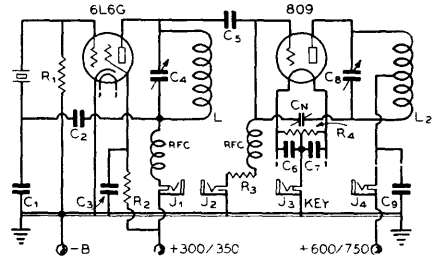

THE FLEX TAL CONVERSION EXCITER

By proper circuit arrangement and choice of constants, it is possible to construct a conversion type exciter that compares with straight crystal control as regards stability and that is relatively free from "birdies". The schematic diagram of such an exciter is given in figure 35. The theory of the heterodyne or conversion type exciter and reasons for its high degree of stability are discussed in the previous chapter.

The Flex tal consists essentially of a crystal oscillator, a pentode amplifier and a low-frequency oscillator modulating the pentode stage, which thence becomes the mixer.

A Pierce oscillator is used because of its simplicity and because of the fact that it will operate with crystals of widely differing frequencies, there being no tuned circuits.

The low-frequency oscillator uses a 42, triode-connected. The 42 was selected because of its ruggedness and large power handling capability (allowing it to "loaf" at low voltages) and its wide element spacing.

The choice of a frequency for the low-frequency oscillator involves several considerations. An output range from the

Flex tal unit of from 3500 to 3650 kc. will provide complete coverage of the 7- and 14-Mc. bands and the c.w. section of the 28-Mc. band together with the most-used portion of the 28-Mc. phone band. To achieve a 3500- to 3650-kc. output range, the low-frequency oscillator must have a range of 150 kc.

While slightly greater stability could be obtained by using a low-frequency oscillator covering from say 300 to 450 kc., the crystal frequency and conversion frequency would be a little difficult to separate without having "birdies" appear in the output, and trouble would be experienced with harmonics of the low-frequency oscillator landing in the high-frequency operating range. So a range of approximately 680 to 830 kc. is utilized. An oscillator can be made quite stable in this range, but because it is in the broadcast band, it is necessary that the Flex tal unit be well shielded. If the unit is not thoroughly shielded, it may bother neighboring broadcast receivers.

Three frequencies appear in the output tank: (1) the crystal frequency, (2) the sum of the crystal and the low frequency, and (3) the difference between the crystal and the low frequency. These

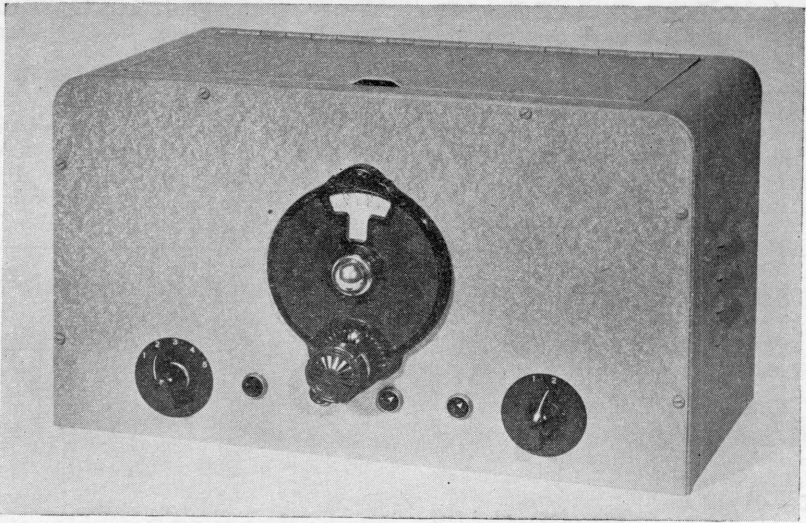

Figure 33. This "Flexital" conversion exciter gives continuous coverage from 3500 to 3650 kc. with virtually complete crystal stability. It can also be used as a straight crystal oscillator for edge-of-band operation.

three are easily separable by the use of a moderate value of C in the tank circuit. In practice, with the 802 plate circuit tuned to the desired peak, it is impossible to get enough energy through on the two unwanted frequencies to be measurable on the grid of the stage following the Flexital unit.

A few simple precautions will provide stable operation of the oscillator. All low-frequency r.f. leads and leads connected to the tuned circuit, as well as any leads that fall in the field of the oscillator coil, should be of heavy bus and firmly anchored at both ends. Any mica trimmers on the tuning condensers should have their setscrews removed and the removable plates bent out at right angles to their normal positions to eliminate the possibility of drift from this cause. The 365- $\mu\text{fd.}$ and 150- $\mu\text{fd.}$ variable condensers used should be of good quality, with heavy, wiping rotor contacts.

With the frequency range of the low-frequency oscillator fixed at 680 to 830 kc. and the output range fixed at 3500 to 3650 kc., the choice of frequency for the crystal oscillator is limited. Either the sum or the difference of the two oscillator frequencies may be used to give the desired range in resultant frequency.

By utilizing the difference in frequencies, a certain amount of compensating action is obtained. This is due to the

fact that an increase of frequency of the low-frequency oscillator causes a decrease in output frequency from the unit, while an increase in frequency of the high-frequency, or crystal oscillator causes an *increase* in output frequency and vice versa.

It is not necessary, of course, that the crystal used for conversion be *exactly* on 4330 kc. Any frequency from 4300 to 4350 kc. will be satisfactory.

In actual practice, most freedom from frequency drift will be obtained when an ordinary inexpensive X-cut crystal is used for the conversion crystal. A moderate amount of negative temperature coefficient is desirable in the conversion crystal, an X-cut crystal having just about the right amount. For the other crystals, those used for working "straight through", low-drift type (AT cut, etc.) crystals will be most desirable, especially if right on the edge of the band.

It should be emphasized that four crystals are extremely desirable, if not absolutely necessary, in the Flexital unit. One is needed near 4330 kc. for conversion use, one on or slightly higher than 3500 kc. to provide an accurate "spot frequency" on the low-frequency end of all bands, a crystal on or slightly lower in frequency than 3600 kc. to use on the high-frequency edge of the 14-Mc. band

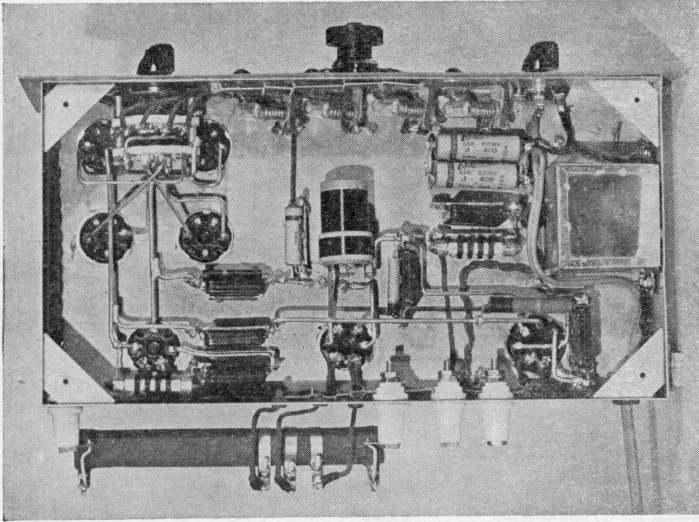

Figure 34. Bottom view of the "Flexal" unit. The b.c.i. coil used in the low-frequency oscillator may be seen right in the center. The bleeder is mounted "outboard" fashion to avoid heating the other components. The filament transformer is cushioned on rubber grommets to avoid vibration of the chassis.

and another similar crystal near 3650 kc. for the high-frequency edge of 7 Mc. For the exclusively phone man, these crystals could be replaced with crystals near 3537.5 and 3562.5 to provide both edges of the 14-Mc. phone band and a marker for the low-frequency end of the 28-Mc. phone band.

Under the subpanel, parts are mounted where convenience dictates. The crystal switch, an Isolantite tap switch, is on the left, directly under the crystal sockets. This switch is a two-gang, four-pole, six-position affair and switches both sides of the crystals along with the jeweled pilot lights on the panel. Three green jewels indicate each of the three spot frequencies available with straight crystal control. The fourth jewel is red and comes on when the 4330-kc. crystal is in the circuit, indicating that the unit is ready to go with variable frequency output.

The filament switch is on the opposite side of the panel from the crystal switch, with the filament transformer behind it and mounted to the side of the chassis. The transformer is mechanically insulated from the rest of the unit by four rubber grommets placed between it and the chassis. The grommets are held in place by a spot of Duco cement on each.

This prevents 60-cycle mechanical vibration of the low-frequency oscillator, which would result in frequency modulation.

The b.c. coil is easily obtainable at radio parts houses. It is of the variety commonly known as an interstage coil and has a sliding primary, which is used as a conveniently adjustable tickler.

Under no circumstance should the voltage divider be mounted under the chassis or inside the cabinet. It is not absolutely necessary that the voltage divider be mounted on the unit at all; it may be located at the power supply and the various voltages brought to the unit through a five-wire cable and plug. Likewise, the filament transformer may be external to the unit, or the filament voltage may be taken from the receiver or transmitter filament supply.

The initial tuning of the unit is best done in the following manner: After the filaments have been lighted, the plate voltage of from 350 to 500 volts should be applied to the unit and the voltage divider taps set to the proper points. Approximate voltages taken from the divider are: 802 suppressor, 50 volts; 42 plate, 175 volts; 76 plate, 250 volts. The total voltage across the divider may be anything from 350 to 500 volts. None of

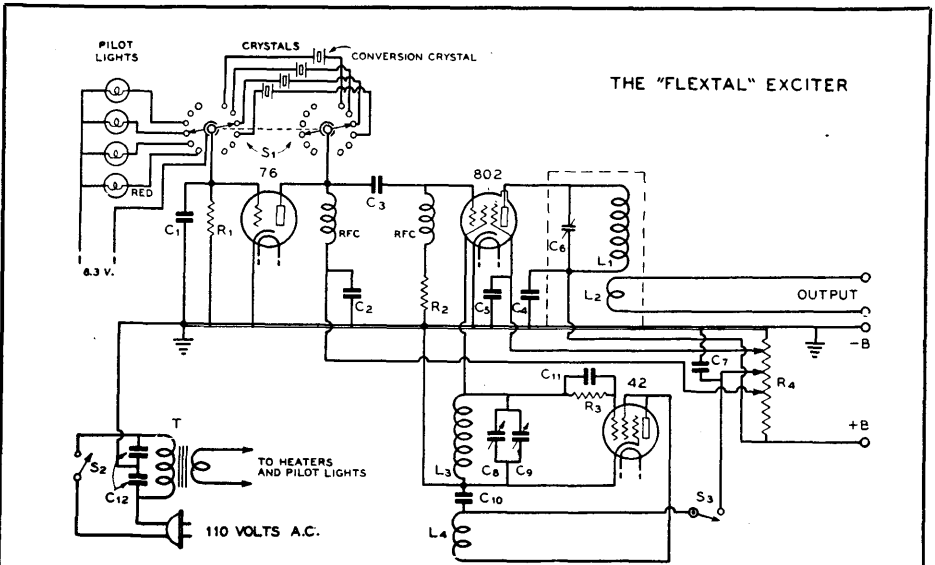

FIGURE 35. WIRING DIAGRAM OF THE "FLEXITAL" CONVERSION EXCITER.

- | | | | |
|--|--|---|--|
| C ₁ —0.001- μ fd. mica | main dial) | watt voltage di- | used here as an |
| C ₂ , C ₃ , C ₄ , C ₆ —0.004- μ fd. mica | C ₁₀ —0.01- μ fd. tubular, 600 w.v. | vider (mount outside cabinet) | adjustable tickler. Remove 30 per cent of the turns from main coil, leaving the primary (tickler) winding intact |
| C ₅ —50- μ fd. midget air trimmer | C ₁₁ —0.0005- μ fd. mica | L ₁ —48 turns no. 22 enam. close wound on 1-in. diam. form | S ₁ —4-pole, 2-gang, 6-position tap switch |
| C ₇ —4- μ fd. or 8- μ fd. 450-v. electrolytic | C ₁₂ —0.1- μ fd. tubular, 400 w.v. | L ₂ —8 turns no. 20 solid pushback wire closewound over cold end of L ₁ | T—6.3-volt 3-a m.p. filament transformer |
| C ₈ —350- or 365- μ fd. b.c.l. condenser used as padder | R ₁ —50,000 ohms, 1 watt | L ₃ , L ₄ —Small b.c.l. interstage coil with sliding primary, | |
| C ₉ —140- or 150- μ fd. tuning condenser (driven by | R ₂ —3000 ohms, 2 watts | | |
| | R ₃ —30,000 ohms, 1 watt | | |
| | R ₄ —25,000-ohm 100- | | |

the voltage adjustments is extremely critical and variations from the above figures will not seriously affect the output. Do not, however, exceed 300 volts on the crystal stage.

After the voltages have been adjusted, the 42 should be removed from its socket and a crystal somewhere between 3500 and 3650 kc. (preferably near 3575) switched into the crystal oscillator circuit. The unit should then have plate voltage applied again and the 802 plate circuit tuned to resonance as indicated by a neon bulb touched to the 802 plate or a flashlight bulb connected across the link terminals. Next, link leads from the transmitter itself should be connected to the Flexital unit and the grid circuit

of the first stage in the transmitter tuned to resonance and the 802 plate tank condenser retuned slightly if necessary.

With these adjustments completed, the plate voltage should again be removed from the unit and the 802 and 76 removed from their sockets. From this point an ordinary b.c.l. receiver will be very helpful. Replace the 42 in its socket and set the low-frequency oscillator tuning condenser at minimum capacity. Slide the tickler coil along the grid winding until its positive end is above the ground end of the grid winding and again apply the voltage. Set the b.c.l. receiver to between 820 and 840 kc., preferably on a b.c. station. Rotate the l.f. oscillator padding condenser until a



Figure 36. This conversion exciter was built in the same cabinet as a combined frequency meter and monitor, both obtaining power from the external supply shown to the left.

strong pure signal is heard. This should occur at about three-quarter maximum capacity of the padding condenser.

Replace the 802 and 76 in their sockets, turn the crystal switch to the 4300 kc. crystal and check the output frequency. It should be near 3500 kc.

Check the bandsread for the 3500- to 3650-kc. range and center it on the dial by readjusting the l.f. padder, remembering that, due to the use of the difference frequency beat, the unit tunes "backward"; that is, an increase in capacity causes an increase in output frequency and vice versa. Tune to the center of the 3500-3650 range and retrim the 802 plate circuit for maximum output. The quality of the signal from the unit should now be checked in the receiver. It should be impossible to notice any difference in the tone of the signal when switching from straight crystal control to control by conversion. Adjust the oscillator feedback by sliding the tickler along the grid winding until the quality of the output is uniformly good over the range of the unit.

The unit is now ready to drive the transmitter either with straight crystal control or on any frequency between crystals merely by setting S_1 to the proper position. The link to the transmitter may be any reasonable length without sacrificing a great deal of output. Twisted lines of widely differing characteristics will affect the tuning range of the 802 plate tank circuit, so

the number of turns on L_1 may have to be changed to suit individual cases.

The output to be expected from the Flexital unit is of the order of five to ten watts, depending upon the supply voltage, and it will replace the present crystal stage in a majority of cases.

Two last precautions: *Always make initial tuning adjustments of the 802 plate circuit with the 42 removed and the unit operating on a crystal between 3500 and 3650 kc.* This will eliminate all possibility of tuning the transmitter to the wrong output peak. Final minor adjustments of this tank circuit may be made with the 4330-kc. crystal and the 42 both in the circuit, and the output set near 3575 kc. If you care to flirt dangerously with the edges of the bands, *use crystals which are known to be safely in for edge-of-band operation and then keep well inside of them* when using the variable frequency control.

EXPERIMENTAL FIELD

The design of exciters offers the amateur a boundless field for experimental and developmental work. Any experimenter may discover that he has certain demands not met by any of the units described on these pages. In such a case he might work out a tube or circuit arrangement more suited to supply his needs.

Final amplifiers remain more or less conventional and tend to follow certain

set lines in their arrangement. Few radical changes are ever made in them, even to accommodate the new tubes which appear periodically. Exciters, on the other hand, do not stick so closely to the orthodox. They are usually low-powered units and lend themselves well

to "new-fangled" applications.

The number of new, useful and economical exciter setups which may be designed is limited only by number of new-purpose tubes available, the experimenter's demands and his ingenuity and originality.

Block Diagrams

Showing comparative output of practical transmitters

It is often desirable to ascertain, at a glance, the approximate output which can be secured from such combinations of tubes as the experimenter may have on hand. Likewise, when a new transmitter is to be designed, the approximate output can be determined in advance by selecting such tube combinations as are shown in the numerous block diagrams in these pages. These diagrams are divided into three classifications: (1) c.w., (2) radiotelephony, (3) combination c.w. and radiotelephony.

The *legend* is a guide to the method used in compiling these diagrams. Single tubes, tubes in push-pull or parallel connection, coupling of the circuits by link, capacitive or unity methods are clearly defined in *legend* and diagram alike.

Directly under each tube symbol is a notation which states the service that the tube is asked to perform; the plate voltage is clearly indicated and the output rating from the final stage is to the extreme right of each block diagram. Relative power output, rather than power input, is shown in each diagram, beginning with low-power and ending with high-power combinations.

Block diagrams for radiotelephone transmitters begin where the diagrams for c.w. transmitters end. Then follow the diagrams for combination c.w.-radiotelephone transmitters.

The method used in presenting these simple block diagrams can be illustrated by the following example, when considering the very first diagram of the c.w. group, directly following this text. It is seen that a 6A6 oscillator, operating on 80 meters, with a plate potential of 450 volts on the oscillator tube, will deliver a power output of 10 watts for c.w. operation. Proceed, then, to the

diagram with two tubes, directly below the aforementioned one-tube diagram. It is here seen that a 6L6 tube acts as a crystal oscillator on 80 meters, with a plate potential of 300 volts on the oscillator tube; the oscillator tube, in turn, is *link-coupled* to a type 210 tube, which serves as a class-C amplifier, on 80 meters, with a plate potential of 750 volts. The result is a power output of 40 watts for c.w. operation.

Capacitive coupling between tubes is indicated by the conventional fixed capacity (condenser) symbol, unity coupling by a letter "U" within a circle.

The attention of the reader is invited to a group of newer combinations which were not shown in previous editions of this *Handbook*. Several of these make use of newly-developed tubes with attractive characteristics.

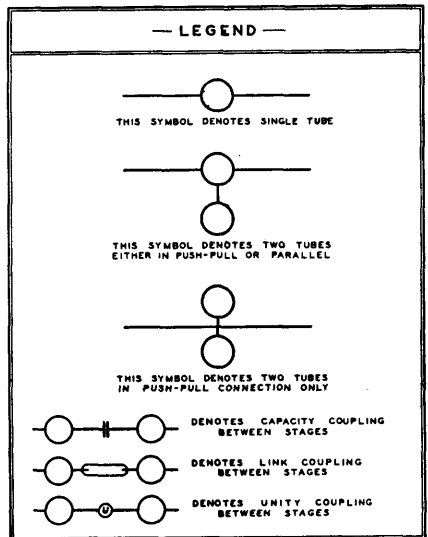

C. W.

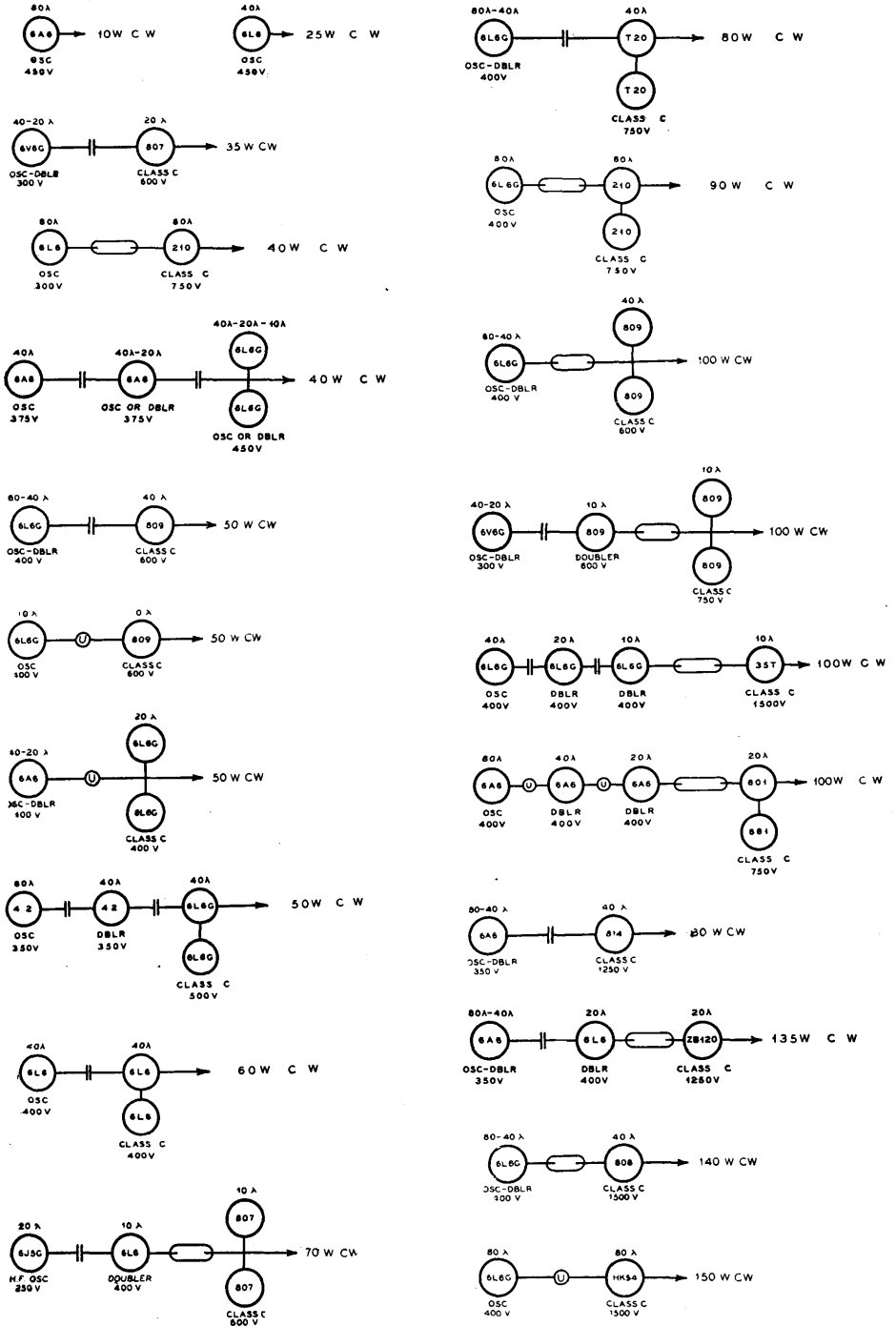

322 RADIO Handbook

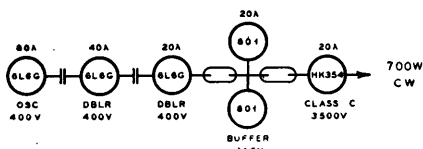
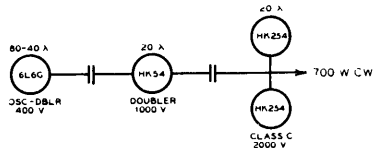
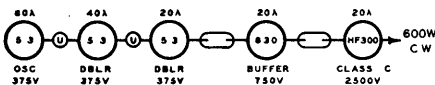
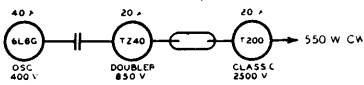
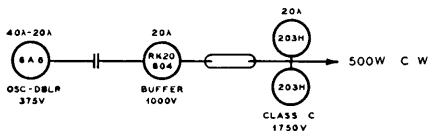
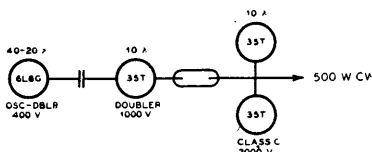
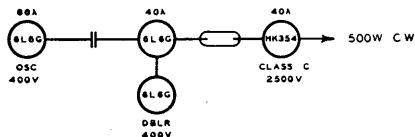
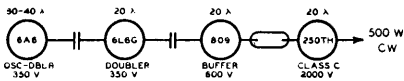
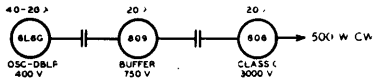
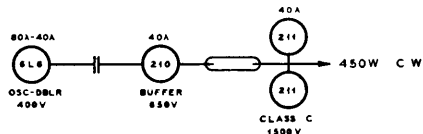
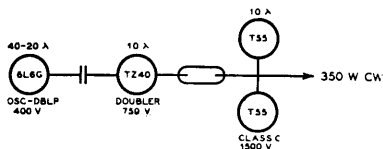
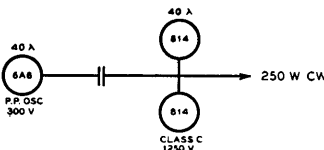
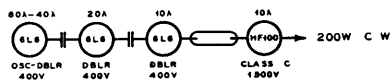
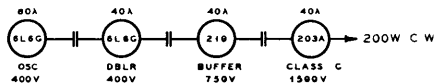
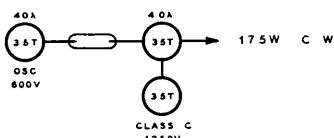
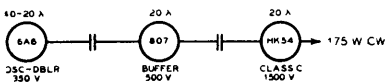
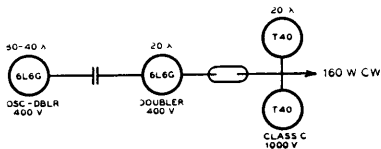
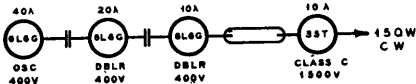
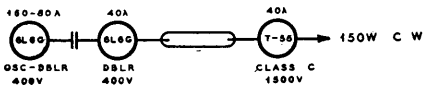

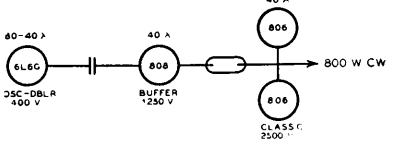
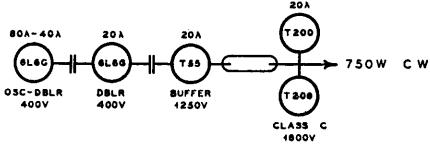
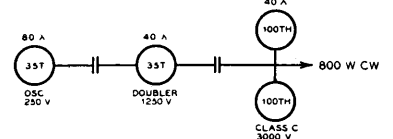
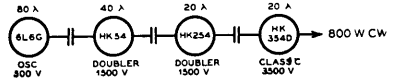
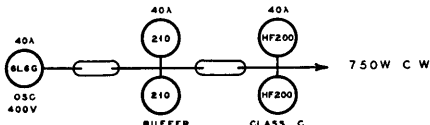

RADIOTELEPHONY

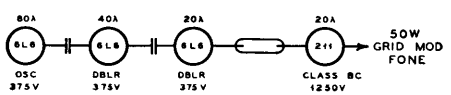
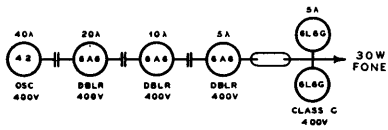
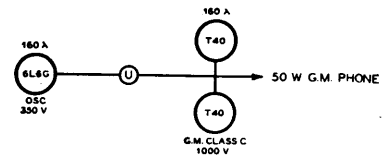
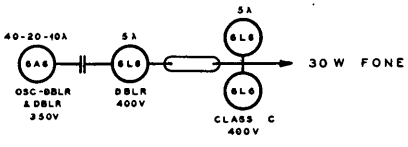
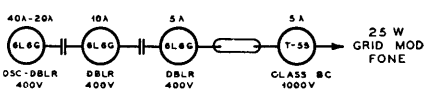
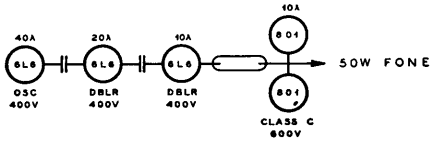
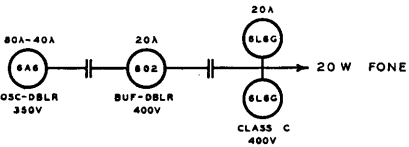
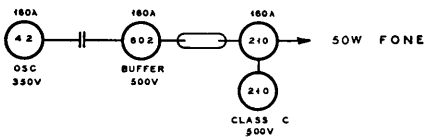
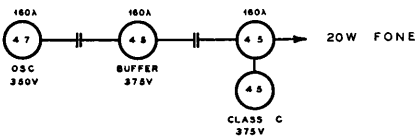
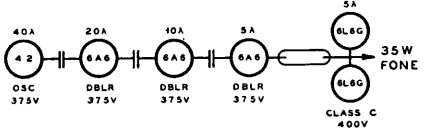
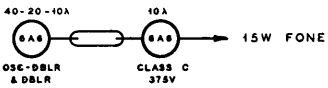

324 RADIO Handbook

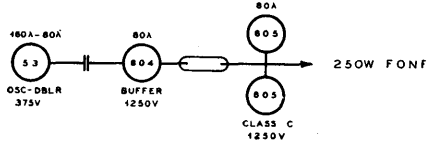
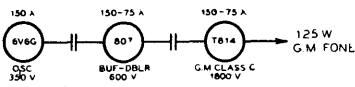
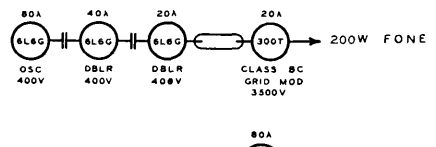
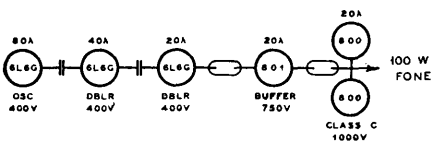
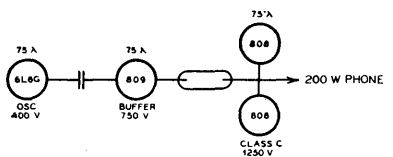
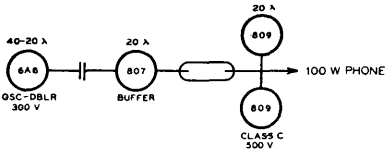
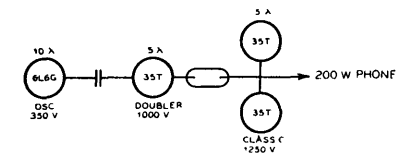
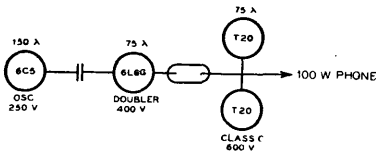
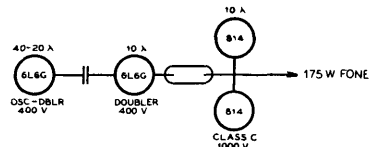
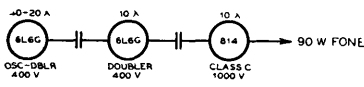
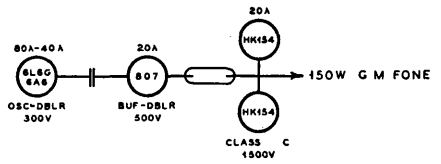
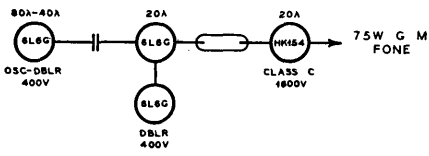
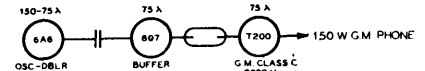
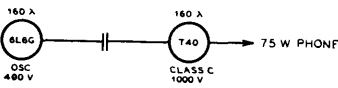
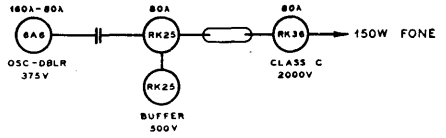
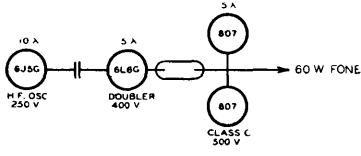
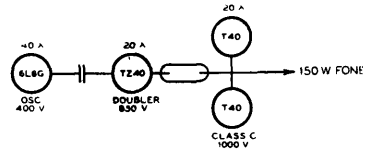
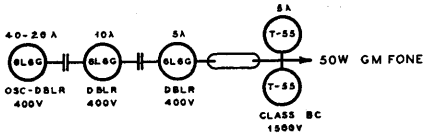

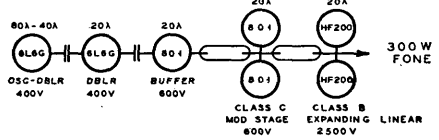
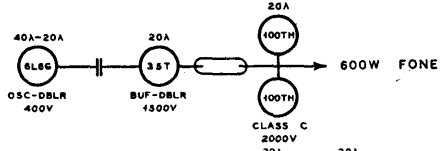
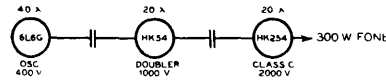
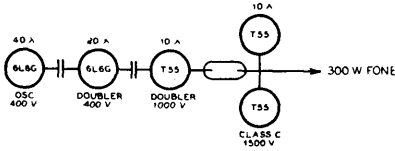

COMBINED C. W. RADIOTELEPHONY

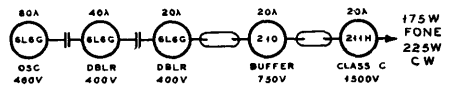
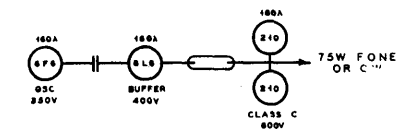
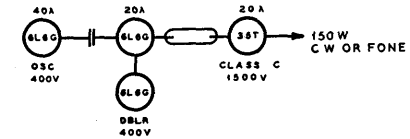
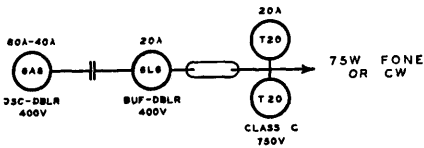
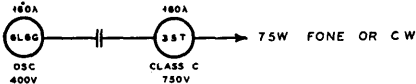
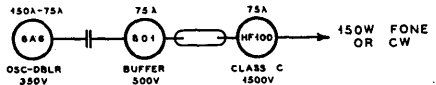
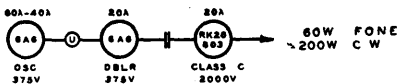
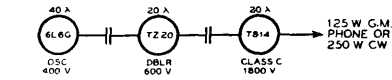
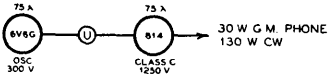
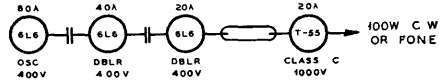
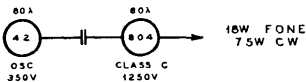
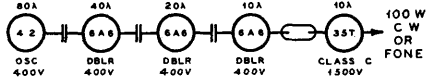
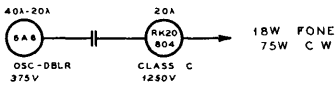
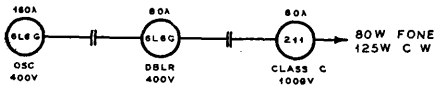
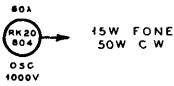

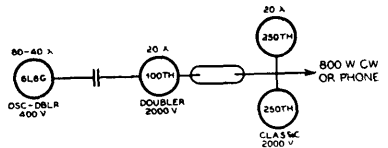
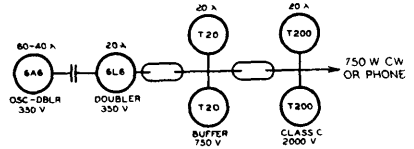
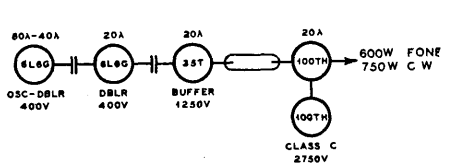
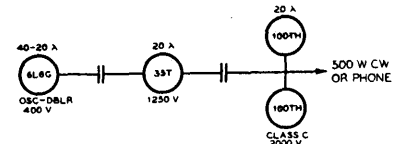
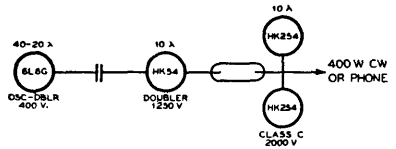
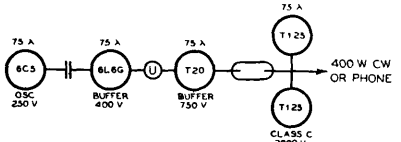
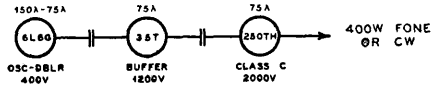
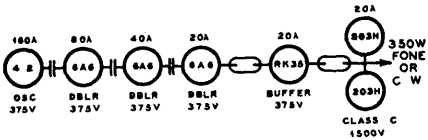
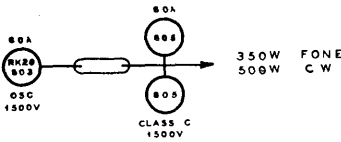
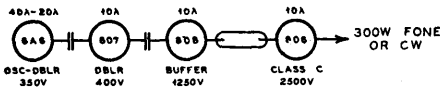
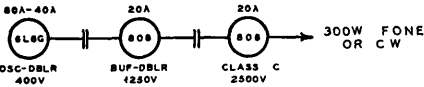
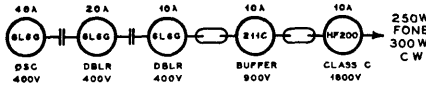
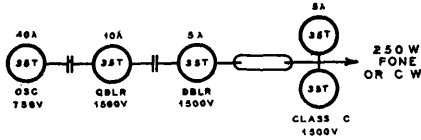
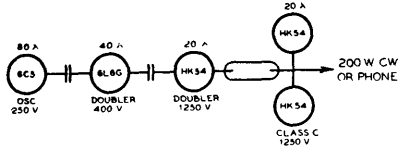
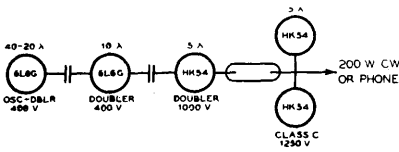

CHAPTER 13

C. W. Transmitter Construction

Modern 50-Watt to 1 Kw. Models—Breadboard and Rack-Panel Layouts—Coil Tables

A TRANSMITTER that is to be used only for c.w. work is not so expensive or critical of construction as the r.f. section of a phone transmitter. It is not necessary that the various stages in a c.w. transmitter neutralize absolutely "stone cold"; in fact, a little regeneration can sometimes be used advantageously to increase the output when shy on excitation. Linearity of the amplifier is relatively unimportant. The c.w. transmitter need not be thoroughly shielded unless one desires to do so; one does not have to worry about r.f. wandering around and getting into the speech amplifier. Less excitation to the final amplifier can be tolerated in a c.w. transmitter than in a plate-modulated phone transmitter, though a reasonable amount is desirable in order to permit good efficiency.

Less Q in the amplifier tank can be used in a c.w. transmitter, and the condenser need not have as much spacing as in a phone transmitter of equivalent carrier power. This means a less expensive tank condenser.

Thus, we see that while the r.f. section of any phone transmitter makes an excellent c.w. transmitter when provision is made for keying, a c.w. transmitter does not always meet the stringent requirements placed on the r.f. section of a phone transmitter. The latter is especially true if the c.w. transmitter has been constructed as inexpensively as is possible for a given power output.

Whether or not an r.f. unit is an exciter or a transmitter depends, not upon its power, but upon whether it is used to drive another amplifier or to feed an antenna. However, in amateur applications, the exciter portion of a transmitter

is generally considered as not including any stages of over approximately 50 watts. If a stage is used between the 50-watt stage and the final amplifier, this stage is commonly called a *driver*. Thus, we see that the terms are relative and depend upon the application rather than the power. We may have a 50-watt exciter, possibly feeding a 200-watt driver or, on the other hand, we may have a 20-watt transmitter, possibly a portable or newcomer's outfit.

In this chapter are described several complete c.w. transmitters and also several medium- to high-power amplifiers. The latter can be used with a suitable exciter from the previous chapter or used to boost the power of an existing transmitter. The excitation requirements can be determined by consulting the data given for the particular type tube used as listed in the chapter on transmitting tubes.

The information required for designing and constructing suitable power supplies will be found in chapter 17. It should be borne in mind that the plate voltage used on a medium- or high-power transmitter is decidedly lethal, and the equipment should not only be handled with due respect for its electrocution possibilities but should be protected or in some means made inaccessible from children and strangers not familiar with the possible danger.

Construction hints that apply to transmitters in general will be found in the chapter on *Workshop Practice*, along with constructional data on standard relay racks for those who wish a commercial-appearing transmitter.

Various sizes of stand-off insulators are available for mounting variable con-

densers and coils at convenient heights above metal bases or chassis. Coils should preferably be mounted a coil-diameter or more from the metal chassis or panels. Large holes should be punched under small coils, tubes and quartz crystal sockets for convenience in wiring. Zinc-coated chassis allow small resistor and condenser leads which carry no r.f. to be soldered directly to the chassis, thus making the leads very short. Power supply leads can be brought to insulators, terminal strips or sockets at the rear of the chassis.

Variable condensers can be driven from dials on the front of the panel by means of insulated extension shafts or by flexible cable couplings. Meter jacks can be insulated from the front panels, when necessary, by means of a 1-inch diameter hole, with the jack mounted on a small strip of bakelite. Rubber grommets should be fitted to the numerous small holes in the chassis through which the individual wires pass, in order to prevent fraying of insulation or flashover from wiring to chassis.

SIMPLE 50-WATT TRANSMITTER

A 6L6G regenerative oscillator of the type discussed in detail in the exciter chapter can be used to drive a neutralized T-20 to between 40 and 50 watts output if a 750-volt plate supply is used for the T-20. As the oscillator works about as well on the second harmonic as on the fundamental with conventional crystals (not the h.f. harmonic cut type),

two-band operation of the transmitter is possible with one crystal on the lower frequency bands.

The breadboard construction with the T-20 mounted on its side permits very short r.f. leads. The T-20 socket should be so oriented that the plate of the T-20 is on edge (vertical) to prevent shorting of the grid and filament as a result of sagging of the latter element due to the horizontal position of the tube.

The vacuum tube keying arrangement shown is inexpensive (45's are dirt cheap) and is highly effective in suppressing key clicks. If desired, the keying tubes can be mounted on the power supply board or chassis instead of at the transmitter.

The 40- and 80-meter T-20 plate coils used in the model illustrated happen to be of the commercially manufactured type and are 1½ inches in diameter. If

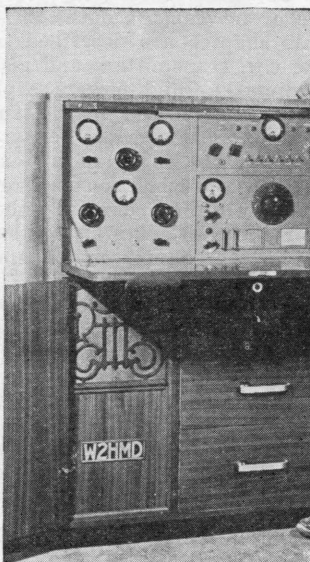

Figure 1. When the transmitter must be placed in the living room and the feminine members of the household complain about unsightly equipment, an old secretary can be picked up from a used furniture store and the transmitter and receiver installed as shown here.

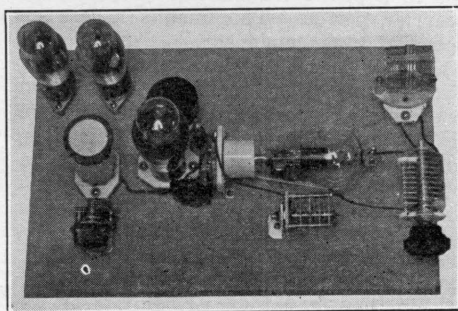

Figure 2. The T-20 amplifier in this simple 2-stage transmitter delivers approximately 50 watts on 80, 40 or 20 meters. Two type 45 keying tubes provide clickless keying.

6L6G—T-20 C.W. SET COIL DATA

COIL BAND	6L6G COIL	T-20 COIL
20	7½ turns #20 d.c.c. 1½" diam. 1¼" long	12 turns 1½" diam. 1¾" long c.t.
40	15½ turns #20 d.c.c. 1½" diam. 1½" long	24 turns 1½" diam. 1¾" long c.t.
80	30 turns #20 d.c.c. 1½" diam. 1½" long	38 turns 1½" diam. 1¾" long c.t.

desired, the coils can be wound on regular 1½-inch diameter forms the same as the 6L6G plate coils, provided a few extra turns are added to make up for the smaller diameter.

Under normal operating conditions at the plate voltages specified, the plate current to the 6L6G should run about 50 ma., the grid current to the T-20 about 20 ma., and the plate current to the T-20 about 75 ma. Three separate meters of suitable ranges are most desirable; however, to cut down the expense, a single 150-ma. milliammeter can be used for all three circuits by incorporating closed circuit jacks where meters are indicated.

The transmitter is an excellent one for the newcomer as it is easy to construct and offers little chance for "bugs." It is easy to tune up and delivers lots of watts output for the money invested. If desired, a high-power amplifier can be added at a later date; the output of the T-20 is sufficient to drive a link-coupled neutralized amplifier to well over 500-watts input with good efficiency if a low-C high-transconductance tube or tubes are used in the amplifier.

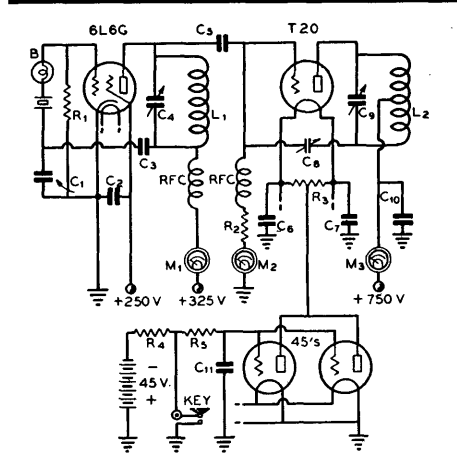

FIGURE 3. WIRING DIAGRAM OF THE SIMPLE 50-WATT TRANSMITTER.

- C₁—0.004- μ fd. mica (critical)
- C₂—0.01- μ fd. tubular
- C₃—0.002- μ fd. mica
- C₄—50- μ fd. midget
- C₅—0.001- μ fd. mica
- C₆, C₇—0.01- μ fd. tubular
- C₈—8- μ fd. double-spaced midget (2000-v. spacing)
- C₉—50- μ fd. double-spaced midget (2000-v. spacing)
- C₁₀—0.004- μ fd. mica, 1000 v.
- C₁₁—0.001- μ fd. mica
- R₁—100,000 ohms, 1 watt
- R₂—5000 ohms, 10 watts
- R₃—75 ohms c.t., 10 watts
- R₄—5 meg., 1 watt
- R₅—10 meg., 1 watt
- RFC—Midget 2.5-mh. r.f. chokes
- B—6.3-v. 150-ma. dial lamp
- L₁, L₂—See coil table
- M₁, M₂, M₃—See text

Those not familiar with correct neutralizing procedure will find the necessary information in the chapter on *Transmitter Theory*.

100-WATT T-40 TRANSMITTER

There is little point in concerning one's self with a power output greater than that of the T-20 rig just described unless one goes to 100 watts, as it is about the smallest increase that will be definitely noticeable to the receiving station. The three-stage transmitter illustrated in figures 4 and 5 will deliver almost 100 watts when fed from power supplies delivering the voltages indicated in figure 6.

The 76 harmonic oscillator is of the regenerative type discussed in detail in the exciter chapter and works on either the fundamental or second harmonic with low-frequency crystals. The 6L6G is neutralized and, therefore, can be used either as a straight buffer or as a doubler. Thus, the T-40 may be driven as a straight amplifier on either 1, 2 or 4 times crystal frequency. By quadrupling in either the oscillator or 6L6G

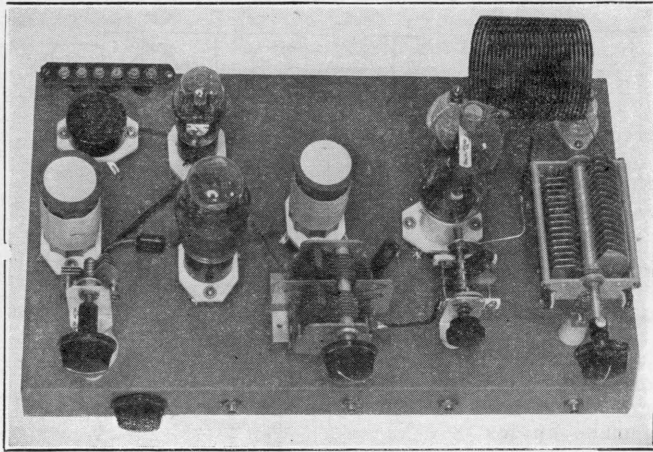
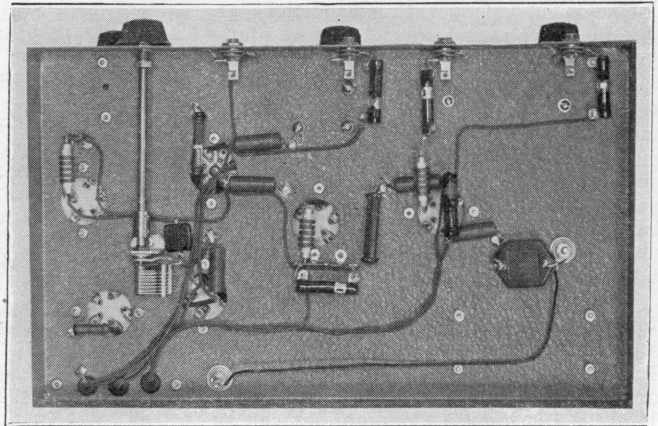

Figure 4. A T-40 is used in the last stage of this three-stage 10-80-meter transmitter. It delivers nearly 100 watts at 1000 volts.

Figure 5. Under chassis view of the T-40 transmitter. An extension shaft permits the variable regeneration condenser to be placed right at the oscillator tube.



stage, it is possible to work the T-40 as a straight amplifier on eight times the crystal frequency but with a reduction in output; the excitation to the T-40 under these conditions is not sufficient for high efficiency, but over 50-watts output can be obtained.

Inspection of figure 6 shows the T-40 to be grid-neutralized. For proper plate tank circuit Q this type of neutralization requires a rather high-C plate tank circuit. If radiated harmonics are to be kept to a minimum, the final tank condenser should resonate with not less than 120 $\mu\mu\text{fd.}$ on 80 meters, 60 $\mu\mu\text{fd.}$ on 40 meters or 30 $\mu\mu\text{fd.}$ on 20 meters. This condition will be met if the coil table recommendations are followed.

It may be found that perfect neutralization of the T-40 cannot be obtained with grid neutralization in the layout

illustrated because of phase shift across C_{10} . It is sufficiently good for c.w. operation, but would not be satisfactory for phone operation. As the transmitter was not designed for phone operation, this is of minor importance. Perfect neutralization can be obtained if desired by altering the transmitter to incorporate plate neutralization for the T-40 instead of grid neutralization. If this is done, a split stator condenser should be used, and the T-40 coil turns should be increased approximately 40 per cent and center tapped.

Keying

Keying should be done in the 76 cathode. Self-bias on the following stages holds the plate current down when the key is up.

T-40 TRANSMITTER COIL DATA

COIL BAND	76 PLATE	6L6G PLATE	T-40 PLATE
10		5 turns—c.t. #16 enam. 1½" diam. 1¼" long	3 turns #12 enam. 2" diam. 1½ turns per in.
20		12 turns—c.t. #16 enam. 1½" diam. 1½" long	5 turns #12 enam. 2½ turns per in. 2½" diam.
40	17 turns #22 d.c.c. 1½" diam. 1½" long	20 turns—c.t. #20 d.c.c. 1½" diam. 1½" long	10 turns #14 enam. 5 turns per in. 2¾" diam.
80	30 turns #22 d.c.c. 1½" diam. 1¾" long	36 turns—c.t. #20 d.c.c. closewound 1½" diam.	17 turns #14 enam. 8 turns per in. 2¾" diam.

Meter readings under typical operating conditions are approximately as follows:

76 cathode: 10 to 15 ma.

6L6G cathode: 40 to 60 ma.

T-40 grid: 30 ma.

T-40 cathode: 150 ma. (120 ma. plate current) max.

FIGURE 6. SCHEMATIC DIAGRAM OF THE THREE-STAGE T-40 TRANSMITTER.

- C₁—100- μ fd. midget
- C₂—.01- μ fd. tubular
- C₃—.001- μ fd. mica
- C₄—50- μ fd. midget
- C₅—.001- μ fd. mica
- C₆, C₇—.01- μ fd. tubular
- C₈—Mica trimmer with screw removed
- C₉—100 or 150 μ fd. per section (remove trimmers if b.c. condenser is used)
- C₁₀—.0001- μ fd. mica
- C₁₁—4- μ fd. double-spaced midget (.07" gap)
- C₁₂, C₁₃—.01- μ fd. tubular, 1000 v.

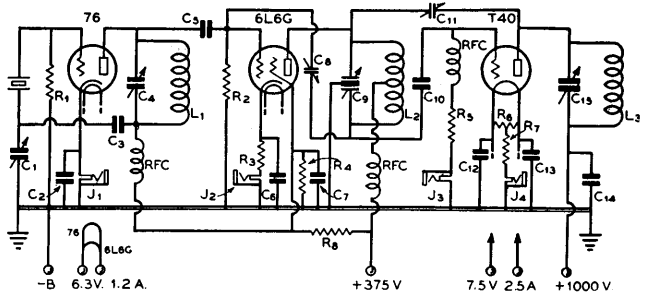

- C₁₄—.002- μ fd. mica, 2500 v.
- C₁₅—140- μ fd., .05" or more air gap
- R₁—50,000 ohms, 1 watt
- R₂—100,000 ohms, 2 watts

- R₃—300 ohms, 10 watts
- R₄—100,000 ohms, 2 watts
- R₅—3000 ohms, 10 watts

- R₆—75 ohms c.t., 10 watts
- R₇—300 ohms, 10 watts
- RFC—Midget 2.5-mh. r.f. chokes
- Coils—See coil table Key at J₁

PUSH-PULL 809 TRANSMITTER

By incorporating a pair of push-pull 809's in place of the T-40 amplifier in the transmitter just described, it is possible to get slightly more output; also, a lower voltage plate supply can be used. These advantages largely offset the additional cost of the push-pull 809 amplifier.

Between 110 and 120 watts can be obtained from the 809's when fed from

a 750-volt supply. A separate 350-volt supply with a bleeder-divider tapped at 250 volts should be used to feed the oscillator and 6L6G buffer-doubler.

Inspection of figure 8 will reveal that the front end of the transmitter is quite similar to that of the T-40 transmitter previously described. The only differences are the use of a fixed regeneration

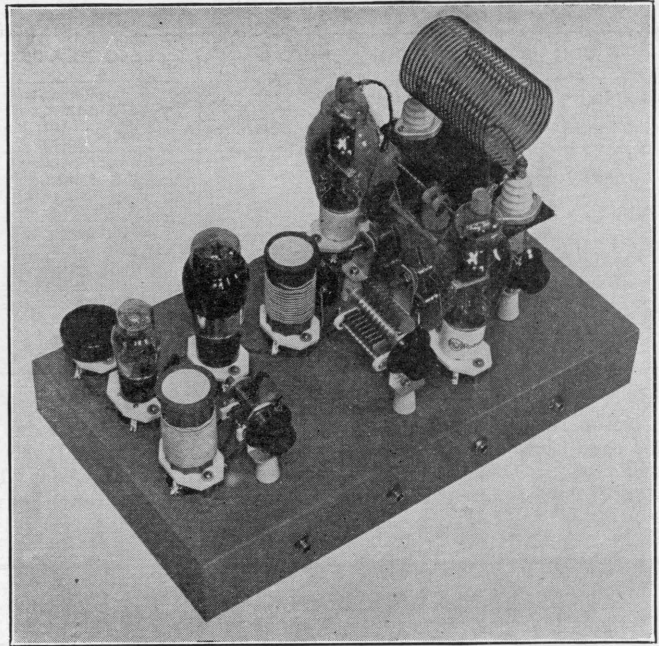

Figure 7. Push - pull 809's in the final stage of this three-band transmitter deliver over 100-watts output at a plate voltage of 750.

condenser in the oscillator and a single-section tank condenser in the plate circuit of the 6L6G.

The fixed regeneration condenser is of such capacity that it permits either fundamental or second harmonic operation with 80-meter crystals. As the 6L6G may be used either as a straight ampli-

fier or as a doubler, 20-, 40-, or 80-meter operation of the transmitter is possible with 80-meter crystals. For 10-meter output, the oscillator may be used on the fundamental with a 20-meter crystal, the 6L6G doubling to 10 meters to drive the 809's on that frequency.

Self-bias on the second two stages per-

FIGURE 8. SCHEMATIC DIAGRAM OF THE PUSH-PULL 809 TRANSMITTER.

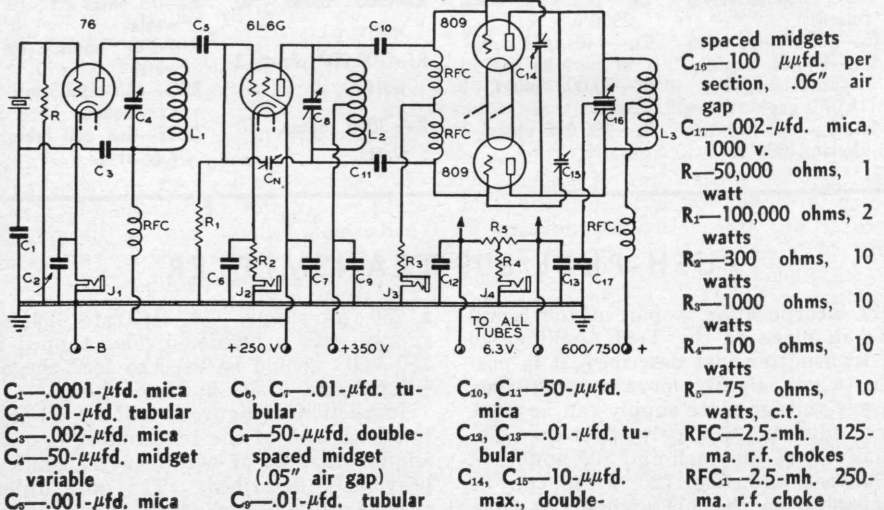

P. P. 809 COIL DATA

COIL BAND	76 PLATE OR 6L6G PLATE	809 PLATE
20	8 turns #22 d.c.c. 1 1/2" diam. 1 1/2" long center-tapped	10 turns #14 enam. c.t. 2 1/2" diam. 4" long
40	16 turns #22 d.c.c. 1 1/2" diam. 1 1/2" long center-tapped	20 turns #14 enam. 2 5/8" diam. 4" long c.t.
80	32 turns #22 d.c.c. 1 1/2" diam. 1 1/2" long center-tapped	34 turns #14 enam. 2 3/4" diam. 4" long c.t.

mits keying of the oscillator for break-in, click-free operation. The 6L6G is neutralized the same as in transmitters and exciters previously described; the screw is removed from a 3-30 μ fd. ceramic-insulated mica trimmer and the movable plate bent in and out until the correct capacity is obtained. The 809 stage is very easily neutralized completely, due to the balanced arrangement

and short leads. The neutralizing condensers should be rotated together when the neutralizing adjustment is made.

The model illustrated is constructed on a 10"x17" standard metal chassis, though it can be built on a breadboard if desired. The same layout of parts can be used with relay rack construction by running extension shafts from the three variable condensers to the front panel. Unless flexible extension shafts are used, the condensers should be mounted so that their shafts are the same height above the chassis and equally spaced and centered with respect to the front panel.

Two meters are desirable for tuning the transmitter: a 0-100 ma. d.c. milliammeter for measuring everything except plate current to the final stage and a 0-300 or 0-350 ma. meter for measuring cathode current of the 809's. The following readings are typical of proper tuning and operation:

- 76 cathode current: 10 to 12 ma.
- 6L6G cathode current: 60 ma.
- 809 grid current: 40 to 50 ma.
- 809 cathode current: 250 ma. max. (approx. 200-ma. plate current)

SIMPLIFIED 150-WATT TRANSMITTER

The N.C.R., A.R.R.S. or traffic man will find the transmitter illustrated in figures 9 and 10 and diagrammed in figure 11 of particular interest. It will deliver from 125 to 150 watts at the voltages indicated, without exceeding the current rating of the 35-T, and has but two tuned circuits. Either 40- or 80-meter operation is possible with 80-meter crystals. The transmitter can also be used to deliver 100 to 125 watts on 20 meters by using a 20-meter crystal in the oscillator.

as diagrammed, as there is no fixed or cathode bias to protect the 35-T. A keying jack, by-passed for r.f., may be placed in the cathode of the 6L6G for oscillator keying if 90 volts of fixed bias is used in place of the 35-T grid leak, R_a.

The particular model illustrated in the photographs was constructed on a standard 10"x17" metal chassis. Short r.f.

6L6G—35-T TRANSMITTER COIL DATA

COIL BAND	6L6G COIL	35-T COIL
20	7 turns #16 enam. 1 1/2" diam. 1" long	10 turns #14 enam. 2 1/2" diam. 2 1/2 turns per in. c.t.
40	15 turns #18 d.c.c. 1 1/2" diam. 1 1/2" long	20 turns #14 enam. 2 5/8" diam. 5 turns per in. c.t.
80	30 turns #20 d.c.c. 1 1/2" diam. 1 1/2" long	34 turns #14 enam. 2 3/4" diam. 8 turns per in. c.t.

The standard regenerative 6L6G harmonic oscillator is capacitively coupled to a 35-T, the latter running as a plate-neutralized amplifier at 1250 volts. If desired, an HK54 may be substituted for the 35-T. Or, a T-55, HF-100 or 808 can be used if a suitable filament transformer is incorporated.

If key clicks are troublesome, a click filter should be incorporated. Data on such filters will be found in the chapter on transmitter theory. Keying this oscillator is not practical in the transmitter

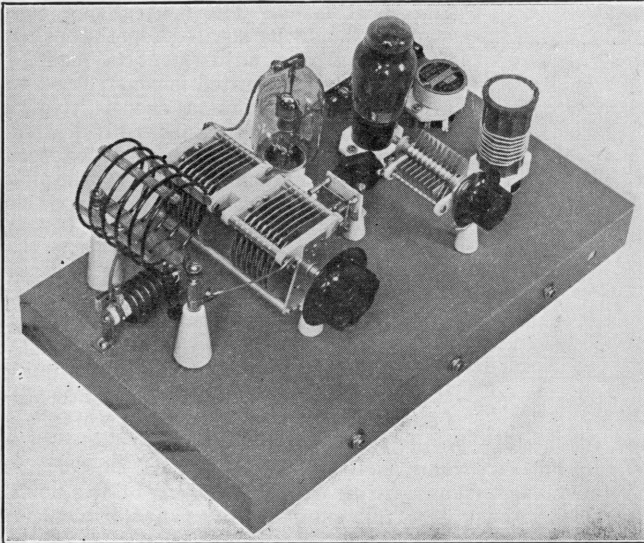

Figure 9. This moderately-powered two-band c.w. transmitter is the acme of simplicity. A regenerative oscillator drives a plate - neutralized 35-T running at 1250 volts.

Figure 10. Only resistors, r.f. chokes and by-pass condensers will be found below the chassis. A single 0-200 ma. meter can be used for measuring the current through the three meter jacks on the front panel.

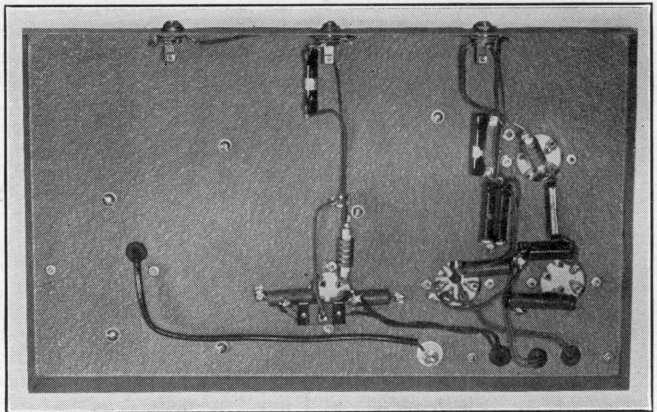
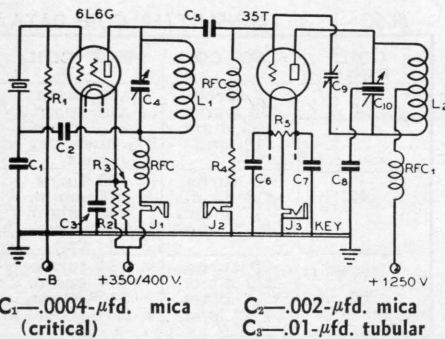

FIGURE 11. WIRING DIAGRAM OF THE TWO-STAGE 35-T TRANSMITTER.



- | | | | | | | | | | | | | | | | |
|---|---------------------------------|-----------------------------------|--|----------------------------------|--|--|---|--|---------------------------------|---------------------------------|--------------------------------|-------------------------------|-----------------------------------|------------------------|--------------------------------------|
| C_1 — $.0004$ - μ fd. mica (critical) | C_2 — $.002$ - μ fd. mica | C_3 — $.01$ - μ fd. tubular | C_4 — 50 - μ fd. midget variable | C_5 — $.0005$ - μ fd. mica | C_6, C_7 — $.01$ - μ fd. tubular | C_8 — $.002$ - μ fd. mica, 2500 v. | C_9 — 4 - μ μ fd. max., $.07$ " air gap | C_{10} — 100 μ fd. per section max., $.07$ " air gap | R_1 — $100,000$ ohms, 2 watts | R_2 — $10,000$ ohms, 10 watts | R_3 — $50,000$ ohms, 2 watts | R_4 — 5000 ohms, 10 watts | R_5 — 50 ohms, c.t., 10 watts | RFC— 2.5 mh. 125 ma. | RFC ₁ — 2.5 mh. 250 ma. |
|---|---------------------------------|-----------------------------------|--|----------------------------------|--|--|---|--|---------------------------------|---------------------------------|--------------------------------|-------------------------------|-----------------------------------|------------------------|--------------------------------------|

leads will result if the constructor adheres strictly to the physical arrangement shown.

Typical meter readings under normal operating conditions are as follows:

6L6G plate current: 50 ma.
 35-T grid current: 20 to 30 ma.
 50T3 cathode: 175 ma. max. (subtract grid current for actual plate current)

DE LUXE 10-METER TRANSMITTER

It is difficult to get maximum efficiency from an all-band transmitter, using plug-in coils or band switching, when operating on the high-frequency bands. This is due to the losses in the coil and socket contacts and losses in the coil forms themselves.

Another problem with all-band operation is the Q of the circuit. Naturally, for 160-meter or 80-meter operation, the tank condensers must have a large capacity for proper operation, whereas the minimum capacities of these same condensers are decidedly too high for 20 or 10 meters.

Building a transmitter for one-band operation, especially on very high frequencies, makes it a simple matter to get maximum efficiency, because the proper Q in each of the tank circuits can be obtained without difficulty.

Here is a foolproof 10-meter 250-watt transmitter using T-40 tubes. It is a straightforward circuit using a 6L6G 40-meter crystal oscillator, a 6L6G doubler to 20 meters, TZ20 doubler to 10 meters and T-40's in the final.

As seen in the accompanying photo-

graphs, it is built on one standard rack and panel unit. The chassis is 11"x17"x3", the panel is 19"x12½". Reading from left to right the meters are: plate current for the oscillator and 1st doubler, 0-150 ma.; plate current for the 2nd doubler, 0-150 ma.; grid current for final, 0-100 ma., and plate current for final, 0-500 ma.

The voltage for the TZ20 power doubler can be obtained through a 3000-ohm 75-watt dropping resistor from the 1000-volt supply. This puts about 750 volts on the plate of this tube.

Typical current readings for this rig when operating are: oscillator and 1st doubler 47 ma., 2nd doubler 65 ma., final grid 45 ma., and the final plate 35 ma. unloaded. The final loaded plate current will vary due to loading and type of antenna used, but should not be allowed to exceed 250 ma. if long tube life is expected.

Coil Specifications

The coils are all wound on a one-inch form and then removed and doped with

Figure 12. Front panel view of the de luxe push-pull T-40 transmitter designed specifically for 10-meter operation.

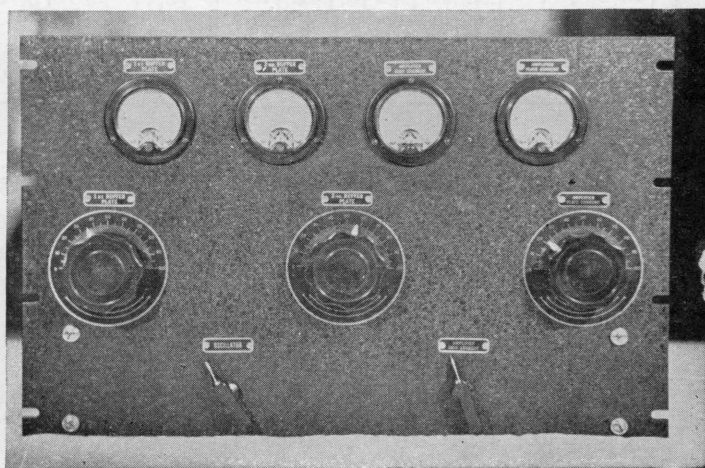

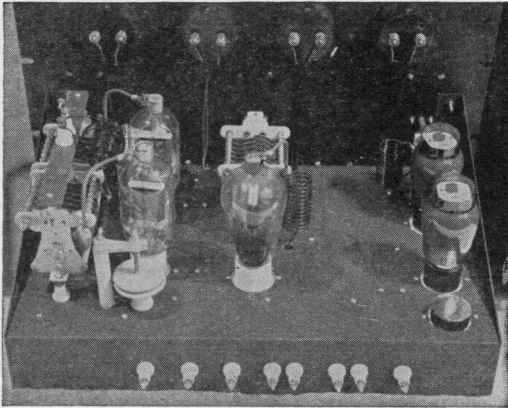

Figure 13. The whole r.f. portion of the transmitter is built on a standard rack chassis and panel. The self-supported air wound coils are soldered directly to the tank condensers.

ribs of Duco cement to make them self-supporting. The oscillator coil consists of 26 turns no. 16 enameled single cotton and is closewound. First doubler coil to 20 meters, 20 turns no. 14 enameled and spaced the diameter of the wire. Second doubler, 12 turns no. 14 enameled spaced about one and a half times the diameter of the wire. Both final grid and plate coils are wound with no. 12 enameled, 12 turns each and spaced equal

to twice the diameter of the wire. All coils are self-supporting as has been mentioned above. Tank coils are soldered directly to the condensers in each case.

Phone

As there are no regenerative circuits in the transmitter and as the final stage is well balanced and neutralizes per-

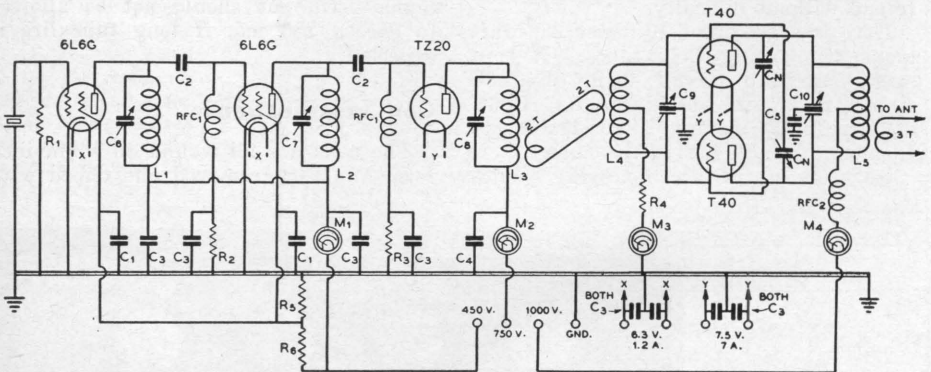

FIGURE 14. WIRING DIAGRAM OF THE DE LUXE 10-METER TRANSMITTER.

- C₁—0.01- μ fd. 600-volt tubular
- C₂—0.00025- μ fd. mica
- C₃—0.002- μ fd. mica
- C₄—0.002- μ fd. 1000-volt mica
- C₅—0.002- μ fd. 2500-volt mica
- C₆—50- μ fd. midget variable
- C₇—35- μ fd. midget var-

- iable
- C₈—50- μ fd. double-spaced midget
- C₉—50 μ fd. per section split stator midget
- C₁₀—50 μ fd. per section, 3000-volt split stator (4000-volt spacing for phone)
- CN—Low - minimum neutralizing condensers

- R₁—100,000 ohms, 1 watt
- R₂—20,000 ohms, 5 watts
- R₃—25,000 ohms, 5 watts
- R₄—3000 ohms, 20 watts
- Coils—See text
- Meters—See text
- RFC₁—2½-mh., 125-ma. chokes
- RFC₂—2½-mh., 250-ma. r.f. choke

Figure 15. A look underneath the chassis reveals that parts are arranged to make each r.f. lead as short and direct as possible.

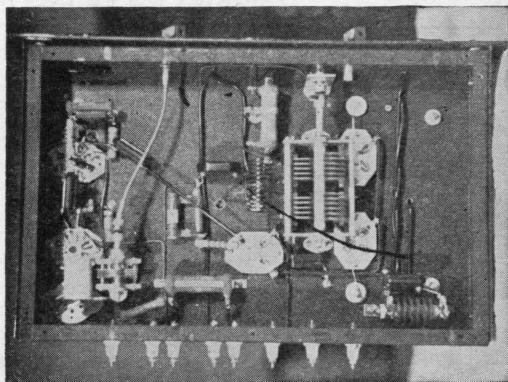

fectly, the transmitter can be used as the r.f. portion of a 10-meter phone transmitter. The final stage should not be loaded to more than 175 ma. on phone as there is not sufficient grid excitation for good linearity when running more

than 175 watts input. A pair of TZ20's in class B running at 600 to 750 volts will make a suitable modulator. The same power supply can be used to feed the TZ20 doubler in the r.f. section if desired.

400-WATT HK54 TRANSMITTER

In figures 16 and 17 is shown a transmitter ending up in a pair of HK54's in push-pull. At 2000 volts it is possible to run a half kilowatt input to the tubes on c.w. A regenerative 6L6G harmonic oscillator of the type previously described in detail feeds a neutralized 809 which acts either as a doubler or straight buffer amplifier. With 40-, 80- or 160-meter crystals it is possible to operate the final amplifier on 1, 2 or 4 times crystal frequency. 35-T's may be substituted in the amplifier if desired; no

changes in the constants need be made.

Keying may be done in the cathode of the 809; if clicks are bothersome, a key click filter may be incorporated. Fixed bias equal to more than cut off on the HK54's protects them when there is no excitation (key up). If break-in operation is desired, a keying jack (bypassed for r.f.) may be placed in the cathode of the oscillator. As 809's are designed for zero bias operation up to 600 volts, no fixed bias is required to protect the tube during key-up condi-

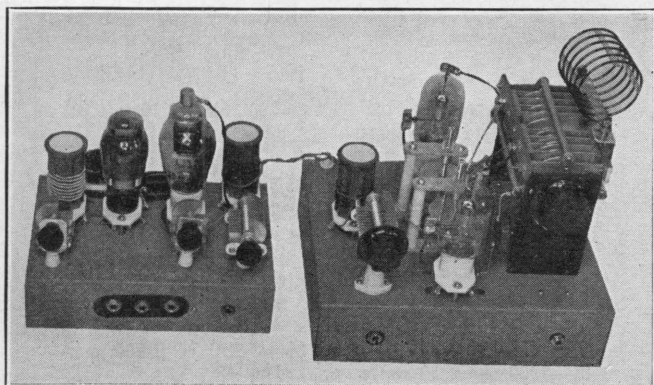

Figure 16. This c.w. transmitter produces an economical 400-watts output on all bands from 10 to 80 meters. Three-band operation is possible from one crystal.

COIL DATA FOR P.P. HK54 C. W. TRANSMITTER.

COIL BAND	6L6G	809 PLATE AND FINAL GRID	HK54 PLATE
80	30 turns #20 d.c.c. 1 1/2" diam. 1 1/2" long	36 turns #20 d.c.c. 1 1/2" diam. Closewound c.t.	30 turns #12 enam. 5" diam. 3 1/2" long c.t.
40	15 turns #20 d.c.c. 1 1/2" diam. 1 1/2" long	20 turns #20 d.c.c. 1 1/2" diam. 1 1/2" long c.t.	20 turns #12 enam. 5" diam. 3 1/2" long c.t.
20	7 turns #16 enam. 1 1/2" diam. 1" long	12 turns #16 enam. 1 1/2" diam. 1 1/2" long c.t.	12 turns #10 enam. 3" diam. 3 1/2" long c.t.
10		5 turns #16 enam. 1 1/2" diam. 1 1/4" long c.t.	6 turns #10 enam. 3" diam. 3 1/2" long c.t.

tions. However, the 809 must be perfectly neutralized or it will tend to self-oscillate when the excitation is removed as during keying of the oscillator. When everything is operating properly, the plate current to the HK54's should drop completely to zero when the oscillator is keyed and the key is up.

Tuning and proper operating conditions for the exciter portion are covered

in the previous chapter under the description of the 6L6G-809 exciter. It should be possible to get at least 40 ma. of grid current on all bands. The HK54's should not be loaded to much more than 250 ma. If slightly lower plate voltage is used, they may be loaded to 300 ma.

Proper tank circuit Q for the various bands can be assured by adhering strictly to the data given in the coil table.

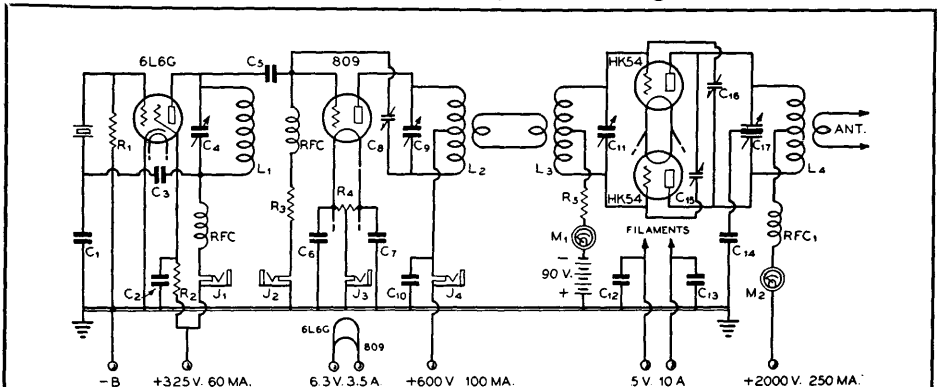

FIGURE 17. WIRING DIAGRAM OF THE 400-WATT HK54 TRANSMITTER.

- C₁—0.004- μ fd. mica
- C₂—0.1- μ fd. tubular
- C₃—0.02- μ fd. mica
- C₄—100- μ fd. midget
- C₅—0.01- μ fd. mica
- C₆, C₇—0.1- μ fd. tubular
- C₈—3-30- μ fd. mica trimmer with screw removed
- C₉—50- μ fd. double-spaced midget
- C₁₀—0.04- μ fd. mica
- C₁₁—50- μ fd. double-

- spaced midget
- C₁₂, C₁₃—0.1- μ fd. tubular
- C₁₄—0.02- μ fd. mica, 2500 volts
- C₁₅, C₁₆—"Micrometer" neutralizing condensers
- C₁₇—40- μ fd. or slightly more per section, 6000-volt or greater spacing
- R₁—100,000 ohms, 1 watt
- R₂—10,000 ohms, 10 watts
- R₃—5000 ohms, 10 watts

- R₄—50 ohms, 10 watts, c.t.
- R₅—1500 ohms, 20 watts
- RFC—2.5 mh. 125 ma.
- RFC₁—2.5 mh. 500 ma.
- M₁—0.75 ma. d.c. or meter jack for same 0-150 ma. meter used for measuring current to exciter
- M₂—0-350 or 0-500 ma. d.c.

R. F. POWER AMPLIFIERS

Regardless of the power output, a c.w. transmitter consists of an oscillator—usually crystal controlled—and successively larger amplifier stages, some of the intermediate amplifiers oftentimes serving as frequency multipliers as well as power amplifiers.

The high-power amplifier stages illustrated can be used to increase the power of the smaller transmitters described at the beginning of this chapter. The medium-power amplifiers illustrated can be used in conjunction with any of the exciters in the exciter chapter delivering sufficient output. The excitation requirements for a c.w. amplifier depend upon the efficiency desired, but an empirical rule that will generally hold is that the output of the exciter or driver

stage should be equal to at least 1/20th of the input one expects to run to the amplifier. More excitation will give greater efficiency and is desirable where the plate dissipation of the amplifier tube or tubes, rather than the voltage or current limitations, limits the output. However, for c.w. work there is little point in running more than twice the above factor of excitation. If the grid drive equals more than 10 per cent of the plate input, the harmonic content goes up and there is little increase in efficiency, though more excitation is sometimes desirable for a plate-modulated stage in order to improve the linearity.

All of the amplifiers illustrated are designed for link coupling from the exciter

FIGURE 18. STANDARD PUSH-PULL R.F. AMPLIFIER CIRCUIT.

Rotor of C_2 may be grounded through a high-voltage mica condenser if RFC is used. If fixed bias is used to permit oscillator keying, R_1 should be reduced a corresponding amount and R_2 omitted. Negative high voltage connects to ground. Note that J_2 reads combined grid and plate current; subtract J_1 reading for actual plate current.

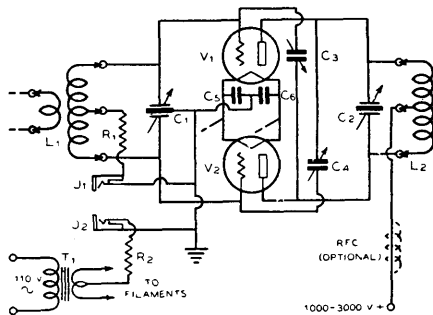

C_1 —Approx. 1 $\mu\text{fd.}$ per section per meter of wavelength. 1000 volt spacing for HK54, 35T, T55, HF100, 808, etc. 2000-volt spacing for 100TH, HK254, HF200, T200, etc.

C_2 —Refer to tank condenser data and Q charts in chapter 11 for capacity and spacing.

C_3, C_4 —Suitable neutralizing condensers, 50% greater air gap than C_2 .

C_5, C_6 —.002 $\mu\text{fd.}$ or larger.

R_1 —Of such value that normal grid current for tubes

will produce enough voltage drop to make a total of twice cutoff bias including any fixed or cathode bias. Higher resistance can be used with slight increase in efficiency if reserve of excitation is available. Wattage rating equal to I^2R .

R_2 —Sufficient to keep resting plate current within maximum plate dissipation rating of tubes (optional). Not practical where very high voltage is used on tubes of small plate dissipation rating

(such as 2000 v. on 35T's); fixed cutoff bias should be substituted in such cases, R_2 being omitted.

RFC—2.5-mh. r.f. choke designed for all-band operation, of suitable d.c. rating. Not always found necessary.

T_1 —Filament transformer of suitable voltage and current rating. Tapped primary desirable, especially if transformer is located some distance from the amplifier.

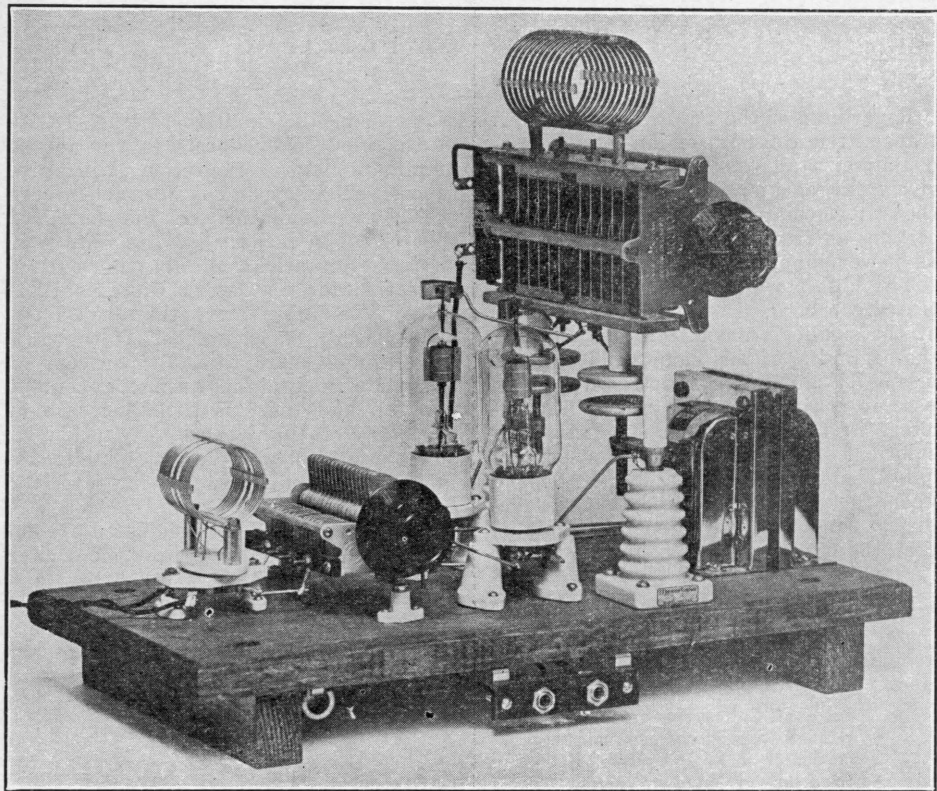

Figure 19. Breadboard amplifier of novel design permitting short leads; no r.f. lead is over 2 inches long. Micrometer type neutralizing condensers are disassembled and mounted as illustrated. Each top plate is wired to the tank condenser section directly above and the grid connections are cross-connected; if top plates are cross-connected, the small pillar insulators will break down. The grid leak is mounted below the baseboard. The tubes pictured are 35-T's.

or driver. This provides the most efficient energy transfer on the higher-frequency bands.

The maximum capacity of the plate tank condenser in these amplifiers depends upon what is the lowest frequency band on which the amplifier is to be used. The correct size for the condenser can be determined from the plate voltage and plate current by referring to the charts given in the chapter on transmitter theory. The voltage breakdown will be approximately the same, but the condenser should have more capacity if the amplifier is to be used on the lower-frequency bands in order to provide sufficient Q at those frequencies. The coils should be designed so that the condenser resonates on each band at approximately

the capacity indicated by the aforementioned charts.

The required air gap of the plate tuning condenser is dependent upon the plate voltage, and the minimum allowable gap can be calculated from the charts and formulas given in chapter 11.

The push-pull amplifiers illustrated all utilize the same circuit, though the proper grid leak value will vary with different tubes. The correct value can be determined from figure 18, the schematic wiring diagram common to all the amplifiers.

The maximum allowable plate voltage, plate current and grid current for the various tubes is given in chapter 10.

The pictorial illustrations are merely for the purpose of furnishing ideas for

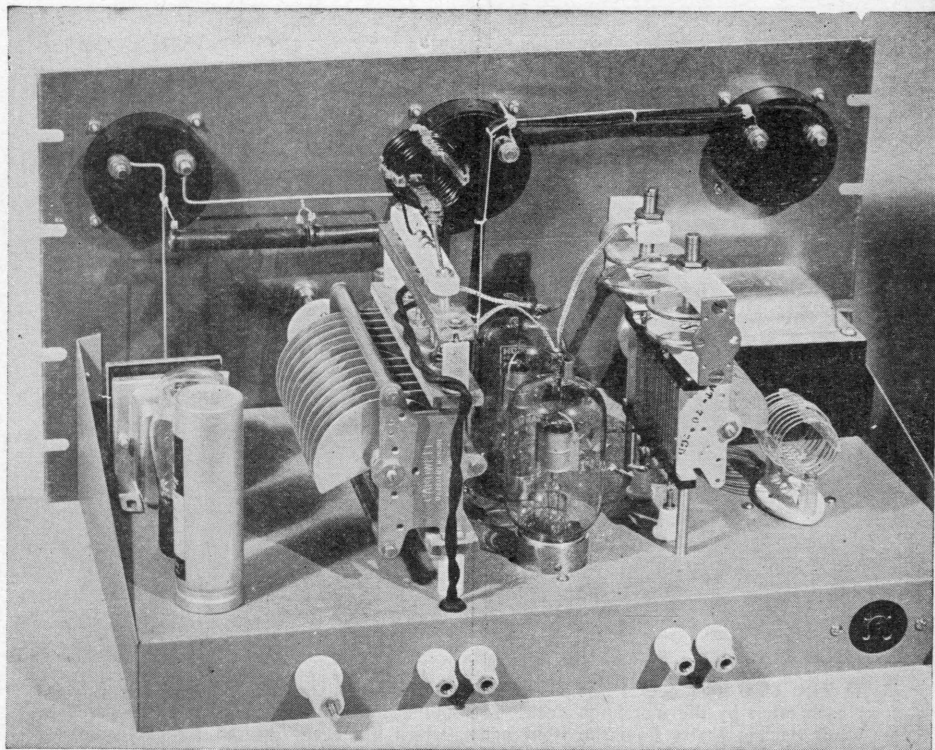

Figure 20. Built upon a standard rack chassis and panel, this amplifier presents more of a commercial appearance than the breadboard outfit of figure 19. Both work equally as well, however. The above amplifier is a bit more costly, but the builder who prides himself on his professional-looking equipment will find it worthwhile. A bias pack has been added to supply fixed bias to permit oscillator keying; the pack may be seen to the left. The filament transformer can be seen to the right rear in the photo. The tubes are HK54's.



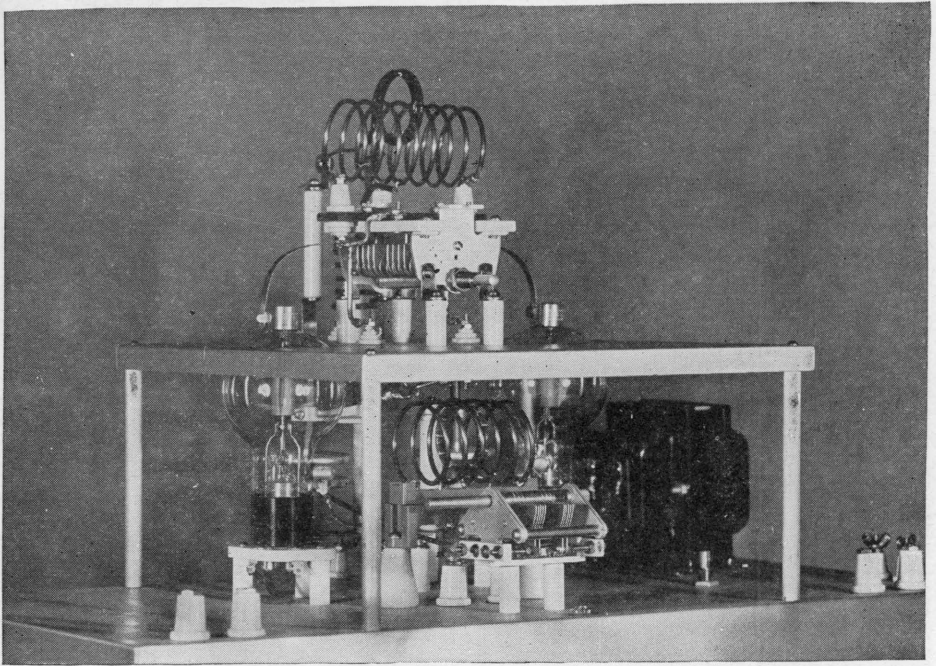
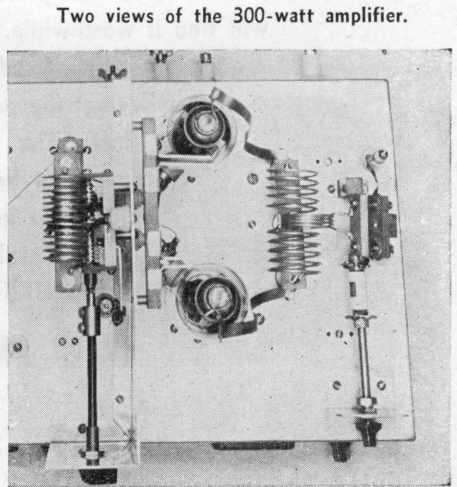
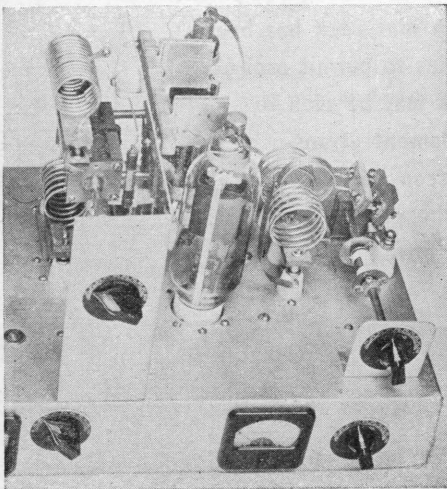

Figure 21. This "two-decker" amplifier has its grid and plate circuits effectively shielded from each other by the metal top deck. The grid and plate tank condensers are driven by means of flexible shafts from the front panel, which has been removed for photographing. In the top deck holes have been cut just large enough to accommodate the tops of the 808's.

Figure 22. (Below) This 300-watt amplifier was designed especially for use on higher frequency bands (5 to 20 meters). As a result of short leads, proper arrangement of parts and careful choice of components, full output on 56 Mc. is obtained. Lower coil to the left of the shield partition is the plate coil for the buffer-driver which, in this model, was built on the same chassis as the HF-100 final amplifier. Buffer plate tank condenser, HF-100 filament transformer and final plate tank condenser are mounted below the chassis. Upper right hand knob varies antenna coupling; upper left hand knob drives grid tuning condenser.



Two views of the 300-watt amplifier.

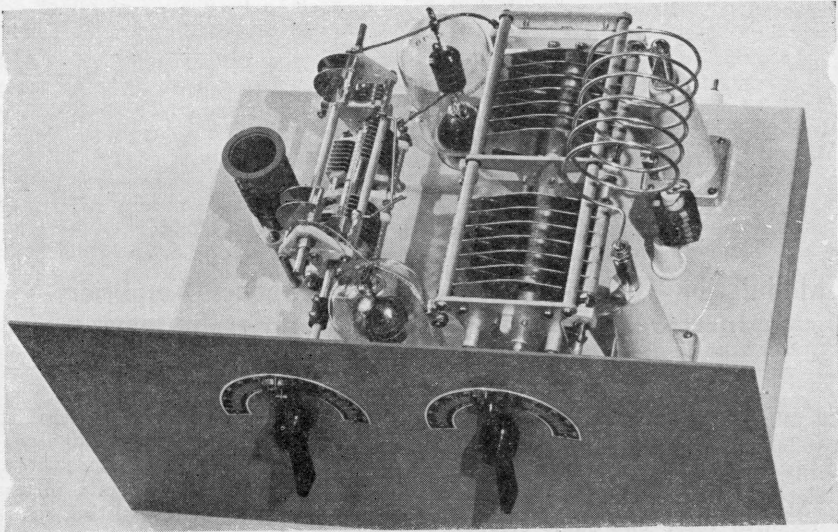
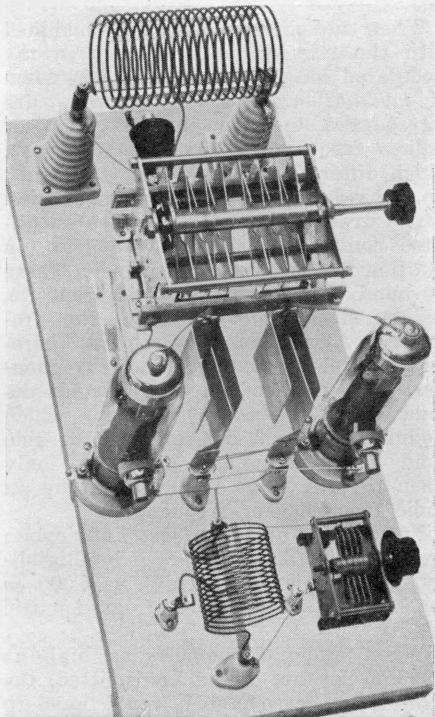

Figure 23. Here is a higher-powered amplifier, one that will take a full kilowatt input on c.w. if 75 watts of excitation is available. High-efficiency operation is required, as otherwise the plate dissipation of the tubes will be exceeded at 1-kw. input. The HK254's are fed 2500 volts and loaded to 400 ma. The physical layout illustrated permits an average r.f. lead length of slightly over 1 inch; no lead is over 2½ inches.

possible mechanical layouts. All of the arrangements shown permit very short r. f. leads, but it is not necessary to use the particular tubes specified in each case for the particular physical layout illustrated. For instance, 35T's, HK54's, 808's, HF100's or T55's could be used in the amplifier pictured in figure 19 by providing the proper grid leak and filament transformer. The latter should preferably be placed right at the amplifier, though it can be placed at the power supply if allowance is made for the voltage drop due to the filament current. The voltage should be correct at the tube sockets.

Figure 24. This high-power breadboard amplifier employing T200's or HF300's, is designed for maximum economy. The neutralizing condensers are homemade, of galvanized sheet iron. Use of T200's or HF300's permits operation at 1-kilowatt input with relatively low plate voltage and excitation power. The tubes will take a kilowatt input at as little as 1500 volts, and only 40 or 50 watts excitation is required. Slightly greater efficiency can be obtained with about 75 watts driving power and higher plate voltage.



CHAPTER 14

Radiotelephony Theory

Modulation Theory—Microphones and Speech Amplifiers— Inverse Feedback—Controlled Carrier Systems— Amplifier-Modulator Block Diagrams

A C. W. TELEGRAPH transmitter has two essential components: (1) *the r.f. channel*, (2) *the power supply*. A radiotelephone transmitter, on the other hand, requires these two same components but with a third component added, the *audio-frequency channel*.

Some means must first be provided to

produce a source of r.f. control, then the desired r.f. frequency must be *amplified* to whatever power output is desired. A quartz crystal plate in an oscillator circuit generates the r.f. *carrier*; this carrier is then amplified (often-times first multiplied in frequency) by additional r.f. stages until the desired power output is obtained.

MODULATION AND SIDEBANDS

When audio frequencies are combined with the r.f. carrier frequency in the modulated stage, the process is known as *modulation*. These frequencies are *heterodyned* together into a group of radio frequencies called *sidebands*, which differ from the carrier frequency by the values of the audio frequencies.

The transmitted signal, when modulated contains *sideband frequencies*, in addition to the carrier frequency. These sideband frequencies are adjacent to, and on either side of, the carrier frequency. A modulated r.f. signal, therefore, occupies a *band* of radio frequencies. The width of these side bands depends upon the audio frequency which modulates the r.f. carrier, and the side band frequencies are generated only when the r.f. stage is modulated by an audio frequency or frequencies.

Frequencies up to at least 1,500 cycles are required for good speech intelligibility, and frequencies as high as 5,000 or 6,000 cycles are required for good music fidelity.

When audio frequencies as high as 5,000 cycles are to be transmitted, the radio-frequency channel would have to

be 10,000 cycles (10 kilocycles) in width, since both the upper and lower side band frequencies are generated in the modulated r.f. stage.

The *average* amplitude of the carrier frequency wave is constant in most systems, but the *instantaneous power output* varies from approximately zero to four times that of the the power of the unmodulated carrier wave. In a sinusoidally modulated wave, the antenna current increases approximately 22 per cent for 100 per cent modulation with a pure tone input; the r.f. meter in the antenna circuit indicates this increase in antenna current. The *average power* of the r.f. wave increases 50 per cent for 100 per cent modulation.

This indicates that in a plate-modulated radiotelephone transmitter the audio-frequency channel must supply this additional 50 per cent increase in average power. If the power input to the modulated stage is 100 watts, for example, this *average power* will increase to 150 watts at 100 per cent modulation, and this additional 50 watts of power must be supplied by the *modulator* when plate modulation is used. The actual an-

tenna power is a constant percentage of the total value of input power.

A c.w. or unmodulated carrier wave is represented in A, figure 1. An audio-frequency wave is represented by curve B. When this audio-frequency wave B is applied to the modulated stage, the resultant wave may be represented as in C and D. The *average amplitude* of the carrier wave remains constant because the decrease in amplitude is the same as the increase (up to 100 per cent). In C, figure 1, the carrier wave is shown to be approximately 50 per cent modulated, and D shows a 100 per cent modulated wave.

In order to obtain 50 per cent modulation in a plate-modulated system, only one-fourth as much audio-frequency power is required as for 100 per cent modulation. However, the audio signal which is received at a distant point after being *demodulated* (detected) is in proportion to the percentage of modulation of the transmitter. If the peaks of modulation are reduced from 100 per cent down to 50 per cent, the result is a decrease in range of the transmitter.

Speech or music sound waves must first be converted into electrical energy. This is accomplished by means of a *microphone*. The electrical power output from a microphone is very low, and must,

therefore, be amplified before it is applied to the modulated radio-frequency stage. Amplification of this weak power output can be accomplished by impressing the electrical output of the microphone across a vacuum tube amplifier system which has sufficient amplification to deliver the desired output.

The electrical power output of the microphone is impressed across the grid impedance of the vacuum tube amplifier, and the voltage is amplified by the vacuum tube. The amplified voltage can then be carried through a number of additional amplifier stages until it becomes a high enough value to develop the desired power.

The audio power output is the value of voltage multiplied by the audio-frequency current flowing through the output impedance; in the case of a low impedance, the current is high and the voltage is relatively low, and vice versa for a high impedance.

The load impedance in the case of a plate-modulated r.f. stage is the plate circuit of the modulated amplifier tube. The impedance can be calculated by dividing the d.c. plate voltage applied to the r.f. stage by the d.c. plate current which is flowing in the tube in that stage. This is equivalent to a pure resistance if the amplifier is class C and, therefore, is a constant load across the output of the audio channel.

Different types of modulated r.f. stages call for vastly different amounts of audio power. Grid modulation, for example, requires only a fraction of the amount of audio power as is required for 100 per cent plate modulation of the same r.f. carrier power. Various types of modulation other than the most common method (plate modulation) are discussed later in this chapter.

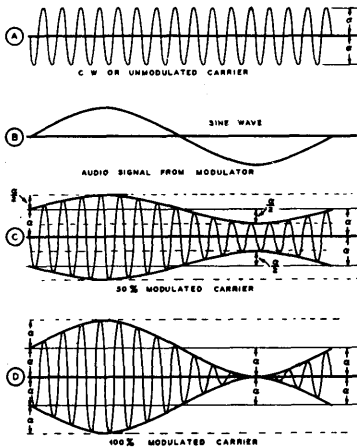

Figure 1. Graphic representation of four types of wave form, illustrating the difference between an unmodulated carrier, audio sine wave, 50 per cent modulated carrier and 100 per cent modulated carrier.

Amplitude Modulation

When the r.f. power output is varied by means of side-band frequency amplitude variations, the method is known as *amplitude modulation*. This is the only system of modulation commonly used by amateurs. The carrier amplitude (except in controlled-carrier systems) should always remain constant. A change in carrier amplitude during modulation is called *carrier shift*. This produces distortion and often creates interference in adjacent radiotelephone channels.

Frequency Modulation

Frequency modulation is just what the term implies and is undesirable for many reasons. The carrier frequency varies with modulating voltage, due to reaction on the oscillator. Reaction between the modulated stage and the

crystal oscillator can be prevented by the incorporation of at least one buffer or doubler stage between the crystal oscillator and the modulated r.f. amplifier. Except for emergency operation, the crystal oscillator should never be modulated because frequency modulation results from any modulation of plate voltage.

MICROPHONES

The microphone, which changes sound into electrical energy, usually consists of a diaphragm which moves in accordance with the compressions and rarefactions of the air called *sound waves*. The diaphragm then actuates some form of device which changes its electrical properties in accordance with the amount of physical movement.

If the diaphragm is very tightly stretched, the natural period of its vibration can be placed at a frequency which will be out of range of the human voice. This obviously reduces the sensitivity of the microphone, yet it greatly improves the uniformity of response to the wide range encountered for voice or musical tones. If the natural mechanically resonant period of the diaphragm falls within the voice range, the sensitivity is greatly increased near the resonant frequency. This results in distorted output, a familiar example being found in the ordinary land-line telephone microphone.

A good microphone must respond equally to all voice frequencies; it must not introduce noise, such as hiss; it must have sufficient sensitivity to eliminate the

need of excessive audio amplification; its characteristics should not vary with changes in temperature or humidity, and its characteristics should remain constant over a useful period of life.

The Carbon Microphone

Carbon microphones can be divided into two classes: (1) *Single-button*, (2) *Double-button*. The single-button microphone consists of a diaphragm which exerts a mechanical pressure on a group of carbon granules. These granules are placed behind the diaphragm between two electrodes, one of which is secured directly to the diaphragm and moves in accordance with the vibration of the diaphragm. This vibration changes the pressure on the carbon granules, resulting in a change of electrical resistance to current flowing between the electrodes, the direct current being supplied from an external source. The variation in resistance causes a change in the current which flows through the primary winding of a coupling transformer, thereby inducing a voltage in the secondary wind-

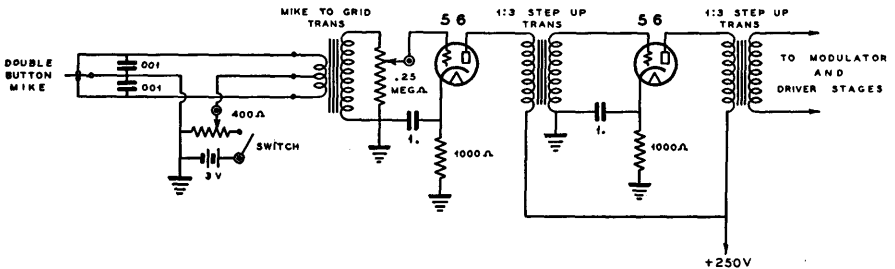

TYPICAL SPEECH AMPLIFIER FOR DOUBLE BUTTON CARBON MICROPHONE OR 200Ω LINE INPUT

FIGURE 2.

ing of this transformer; this voltage is then amplified by means of vacuum tube amplifiers.

Single-button microphones are useful for operation in portable transmitters because their sensitivity is greater than that of other types of microphones, thereby requiring less audio amplification to supply audio modulating power for the transmitter. The objectionable feature of the single-button microphone is its high hiss level. Another is that the diaphragm generally resonates within the voice range, resulting in mediocre tone quality. The better microphones of this type, however, are highly intelligible even though lacking somewhat in fidelity.

Double-Button Microphones

The double-button microphone has two groups of carbon granules arranged in small containers on either side of the diaphragm. This push-pull effect reduces the even-harmonic distortion, resulting in more intelligible modulation. The diaphragm is normally stretched to such an extent that its natural period may be as high as 8,000 cycles per second, which is beyond the range of the human voice. This reduces the sensitivity of the microphone and greater audio amplification is needed to secure the same output as from a single-button carbon microphone. On the other hand, the tone quality from the double-button microphone is better, though the hiss is still present.

The cost of a double-button microphone is a satisfactory index of its performance when purchased from a reliable concern. The output from a *high-quality* two-button microphone is about 45 db below that of a standard single-button microphone.

Condenser Microphones

A condenser microphone has a better frequency response than a carbon microphone and it does not produce a hiss. This type of microphone consists of a highly damped or stretched diaphragm mounted very close to a metal plate, but insulated from the plate. The movement of the diaphragm changes the spacing between the two electrodes, resulting in a change in electrical capacity. When a d.c. polarizing voltage is applied across the plates, an a.c. voltage will be generated when the diaphragm is actuated by reason of the change in capacity between the plates; this voltage can then be amplified by means of vacuum tubes. The diaphragm of a typical condenser microphone is made of duralumin sheet, approximately 1/1,000 in. thick, with approximately the same spacing between the diaphragm and the rear heavy plate electrode. The output is approximately 75 db below an ordinary single-button carbon microphone with unstretched diaphragm.

The condenser microphone has a low output level, which necessitates at least two stages of preamplification, the first stage being located very close to the microphone. The output impedance is extremely high and the unit must, therefore, be well shielded in order to prevent r.f. and 60-cycle a.c. hum pickup. It is sensitive to changes in barometric pressure and humidity. More modern types of microphones are replacing the condenser type, although the latter are still widely used.

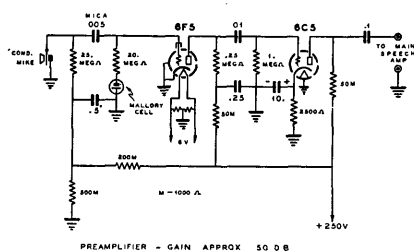

Figure 3. Condenser microphone preamplifier. This preamplifier is used with a condenser microphone in order to increase its output to a sufficient level to work directly into the grid of a speech amplifier, such as one which was originally designed for carbon microphone input. No transformer is needed for coupling between the 6F5 and the speech amplifier. The 0.1- μ fd. coupling condenser and the speech amplifier grid leak should be located at the speech amplifier.

Crystal Microphones

The crystal microphone operates on the principle that a change in dimensions of a *piezoelectric* material, such as *Rochelle salt crystals*, generates a small a.c. voltage which can be amplified by means of vacuum tubes. No d.c. polarizing voltage or current or coupling transformer is required for the crystal type of microphone; thus, it becomes a very

simple device to connect into an audio amplifier.

Crystal microphones can be divided into two classifications: (1) the diaphragm type, (2) the grille type.

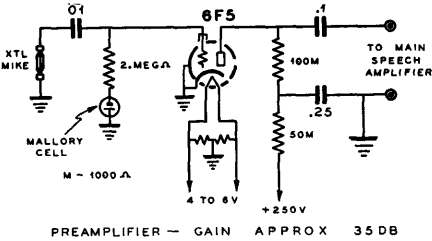

Figure 4. This preamplifier can be used with an inductive microphone by changing the resistance network in the input to a transformer of the correct design. If the preamplifier is far removed from the main speech amplifier, a plate-to-500-ohm-line transformer should be connected in the output, with a corresponding 500 ohm-to-grid transformer at the speech amplifier.

The diaphragm type is relatively expensive and consists of a semifloating diaphragm which subjects the crystal to deformation in accordance with the applied sound pressure. The fidelity is equal to that of most two-button carbon microphones and there is no background noise or hiss generated in the microphone itself.

The grille type consists of a group of crystals connected in series or series-parallel for the purpose of obtaining high

electrical output without aid of a diaphragm.

The output level varies between -55 db and -80 db for various types of crystal microphones. The grille type is less directional to sound pickup than most other types and is capable of almost perfect fidelity.

Velocity or Ribbon Microphones

The inductive or ribbon-type microphone has a thin, corrugated, metal strip diaphragm which is loosely supported between the poles of a horseshoe magnet. A minute current is induced in this strip when it moves in a magnetic field, and this current can be fed to the primary of a step-up-ratio transformer of high ratio because of the very low impedance of the ribbon.

The microphone output must be amplified by means of a very high gain preamplifier, because the output level of the older types of ribbon microphones is -100 db and even the newer ones are around -85 db. The inductive type of microphone is rugged and simple in construction. Unfortunately, it cannot be used for close talking without over-emphasizing the lower frequencies. It is a velocity, rather than a pressure-operated, microphone and should therefore be placed at least two feet from the source of sound. It is very sensitive to a.c. hum pickup, and this is one of the principal reasons why it is not widely used in amateur practice.

The impedance of the ribbon is so low that it is difficult to design a ribbon-to-grid transformer with good fidelity.

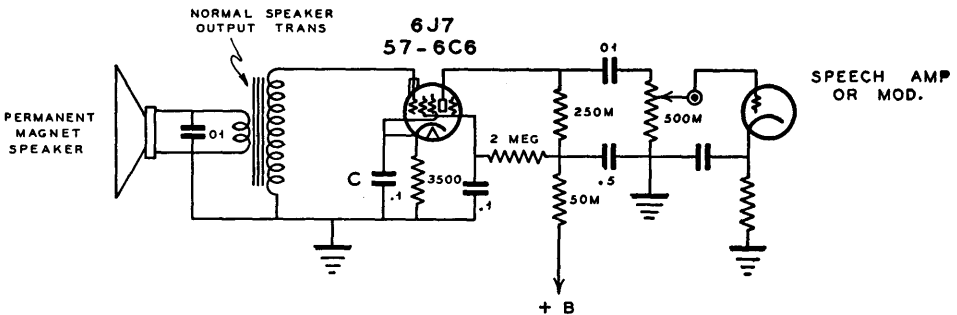
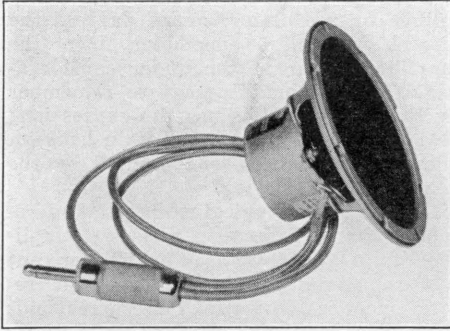

FIGURE 5. LOW COST DYNAMIC MICROPHONE INPUT AMPLIFIER.



A small PM speaker makes a good microphone.

Therefore, for best quality, two transformers are usually used in cascade: ribbon-to-200 ohms and 200 ohms-to-grid.

The Dynamic Microphone

The dynamic (moving coil) type of microphone operates on the same principle as the inductive microphone. A small coil of wire, actuated by a diaphragm, is suspended in a magnetic field, and the movement of the coil in this field generates an alternating current. The output impedance is approximately 30 ohms as against approximately one ohm for the ribbon type of micro-

phone. The output level of the high fidelity types is about -85 db, the level varying with different makes. The output level of the p.a. types is somewhat higher and the fidelity is almost as good. This type of microphone is quite rugged, but has the disadvantage of picking up hum when used close to any power transformers.

An inexpensive and very satisfactory dynamic microphone for amateur transmitters can be made from a small, permanent-magnet type, dynamic loudspeaker, as illustrated on this page. One of the newer 5-in. types with alloy magnet will give surprising fidelity at relatively high output level.

A shielded cable and plug are essential to prevent hum pickup. The unit can be mounted in any suitable type of container. The circuit diagram is shown in figure 5.

Directional Effects

Crystal microphones, as well as those of some other types, can be mounted in a spherical housing with the diaphragm oriented horizontally in order to secure a non-directional effect. Decidedly directional effects may be required, on the other hand, and microphones for this purpose are commercially available.

SPEECH AMPLIFIERS

That portion of the audio channel between the microphone or its pre-amplifier and the power amplifier or driver stage can be defined as the *speech amplifier*. It consists of from one to three stages of *voltage amplification* with resistance, impedance or transformer coupling between stages. The input level is generally about -50 db in the case of a speech amplifier designed for a double-button carbon microphone or pre-amplifier input. The input level is approximately -70 db when the speech amplifier is designed for operation from a diaphragm-type crystal microphone. A conventional speech amplifier for a double-button carbon microphone is shown in figure 2. Other speech amplifier circuits are shown in the chapter on *Radiotelephone Transmitter Construction*.

It is possible to dispense with the

preamplifier with certain types of low-level microphones by designing the speech amplifier input to work at -90 db or so, but it is better practice and entails less constructional care if a speech amplifier with less gain is used, in conjunction with a preamplifier to make up the required overall amplification. Less trouble with hum and feedback will be encountered with the latter method.

Designing a speech amplifier to work at -70 db is comparatively easy, as there is little trouble from power supply hum getting into the input by stray capacitive or inductive coupling.

Amplifier Gain

The power gain in amplifiers or the power loss in attenuators can be conveniently expressed in terms of db units, which is an expression of two power ratios. (See chapter 3.)

A formula for the calculation of db gain or loss is here given:

$$DB = 10 \times \log_{10} \frac{P_2}{P_1}$$

Since power is equal to the product of voltage times current when the power factor is unity, db units can be used to express voltage gain. In this case the formula is:

$$DB = 20 \times \log_{10} \frac{E_1}{E_2}$$

This provides a useful means for computing the overall voltage gain of a preamplifier and the speech amplifier. When adding the gain of several stages, the db units are added or subtracted, which greatly simplifies the calculations.

For example: if a preamplifier has 35 db gain, and the speech amplifier has 65 db gain, the total gain is 35 + 65, equals 100 db. One hundred db corresponds to a voltage gain of 100,000 times. Thus, for example, if the microphone level is -100 db the speech amplifier output will be -100 db + 100 db, or zero db level. Zero level corresponds to a power level of 6 milliwatts.

In order to obtain 60 watts of audio power output, a power gain of 6,000 times will be required, which corresponds to a power gain of approximately 38 db. This amplification can be con-

sidered as part of the main power amplifier or modulator, or as part of the speech amplifier, depending upon the particular transmitter under consideration. The important point to remember is that power ratios use the expression: $10 \times \log$, whereas voltage gain between similar impedances is computed by the expression: $20 \times \log$.

Let us take a typical example of radio-telephone transmitter with a class-C amplifier input of 200 watts. For 100 per cent plate modulation, the audio power requirement is 100 watts. This corresponds to a db power level of +42 db. Zero db level is 6 milliwatts or .006 watt. (Refer to db power table in chapter 3.)

Therefore, the formula:

$$DB = 10 \times \log_{10} \frac{P_1}{P_2} = 10 \times \log_{10} \frac{100}{.006} = 42$$

The amateur may desire to use a diaphragm type crystal microphone which is rated at -70 db for average sound levels. This extremely low output must be brought up to a value of 100 watts or +42 db. The total gain required will be 112 db.

No preamplifier would be necessary, because this amount of gain can be built into a good speech amplifier and modulator. A typical audio channel which

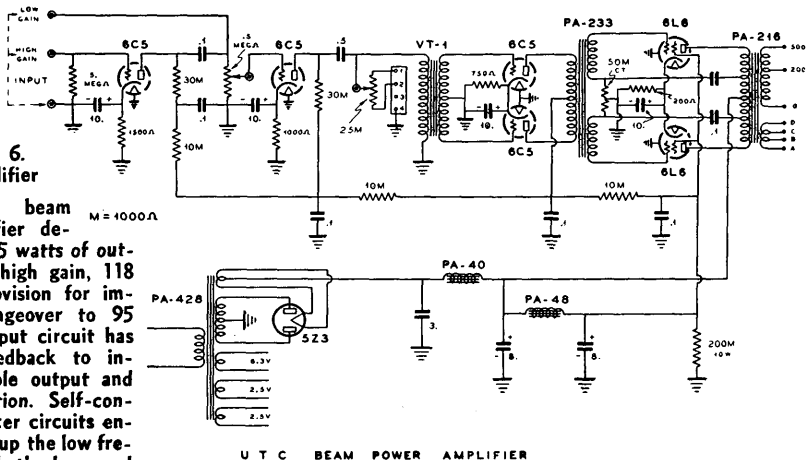
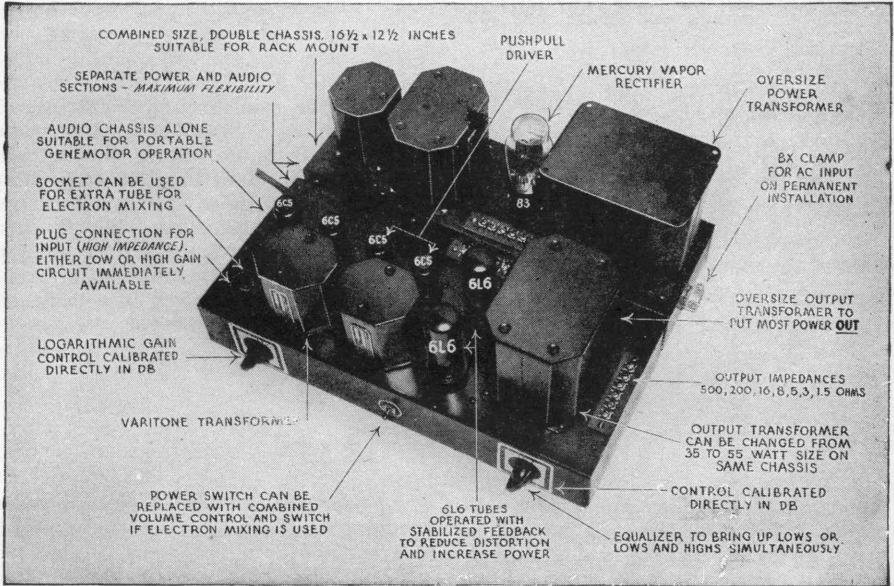

FIGURE 6.
6L6 Amplifier

This PAK-1 beam power amplifier delivers 35 to 55 watts of output. It has high gain, 118 db., with provision for immediate changeover to 95 db. The output circuit has stabilized feedback to increase available output and reduce distortion. Self-contained equalizer circuits enable bringing up the low frequency, or both low and high frequencies simultaneously. All resistors are rated at one watt, except bleeder and 6L6 cathode resistors, which are 20-watt.

U T C BEAM POWER AMPLIFIER



meets these requirements is shown in the skeleton circuit, figure 7.

The first speech amplifier consists of a 6C6 connected as a high-gain pentode, resistance-coupled to a 76 speech amplifier which, in turn, is coupled through a step-up transformer into a 42 tube which operates as a triode. The latter is connected to a push-pull 45 class-AB driver for the final power amplifier or modulator consisting of a pair of 35T's.

The 6C6 stage is capable of producing a voltage amplification of 100 times, which corresponds to 40 db.

$$DB = 20 \times \log_{10} \frac{100}{1} = 40$$

The 76 and 42 triodes with a 3-to-1 stepup interstage transformer will produce a voltage gain of 240.

$$DB = 20 \times \log_{10} \frac{240}{1} = 47$$

Actually, the db voltage gain must be measured between like impedances in order to be correct.

The total speech amplifier gain is 40 + 47, equals 87 db. If the output level of the microphone is -70 db, the output level of the 42 triode will be 87 - 70, equals +17 db. This level corresponds to approximately 300 milliwatts, which is well within the rating of a 42 triode driver, and is sufficient to drive the 45 tubes in class AB.

$$17 = 10 \times \log_{10} \frac{P}{.006}$$

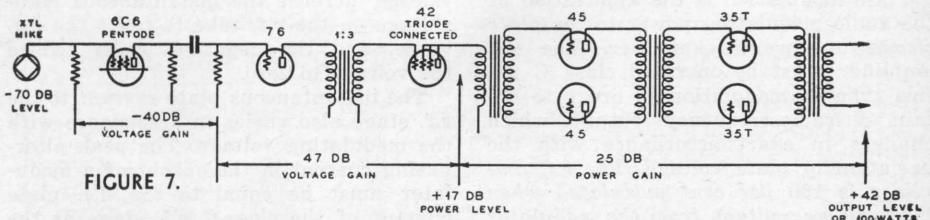

FIGURE 7.

COMPUTATION OF GAIN FOR AUDIO CHANNEL OF RADIO TRANSMITTER

therefore, P equals 0.3 watt or 300 milliwatts.

$$DB = 10 \times \log_{10} \frac{100}{0.3} = 25$$

This can be checked by subtracting 17 from 42, which is 25 db, the power gain between the grids of the 45 tubes and the output of the class-B modulator.

With 0.3 watt input to the 45 stage, 9 watts of output can be obtained.

$$DB = 10 \times \log_{10} \frac{9}{0.3} = 15$$

The power gain through the 45 stage is 15 db, leaving a power gain of 10 in the 35T class-B stage. More power gain could be secured in the 35T stage, thus requiring less gain in the 45 driver stage, and therefore the class-B input transformer could have a greater step-down ratio than in the case of a circuit design in which no leeway in voltage and power gain is provided for.

Modulators

A *modulator* supplies audio power to the particular r.f. stage in the transmitter which is being modulated. A speech amplifier does not deliver sufficient power output for modulating a conventional form of r.f. stage delivering more than a very few watts power. The modulator is an audio amplifier which delivers ample power output for completely modulating the d.c. input to the modulated stage. Power requirements of audio amplifiers vary from a fraction of a watt up to 500 watts, for amateur purposes. Low-power transmitters of the grid-modulated or suppressor-grid-modulated types require less than one watt of audio power, whereas a 1-kw. plate-modulated phone transmitter requires 500 watts of audio power for 100% sine-wave modulation.

Class-A amplifiers are suitable for

low-power grid-modulated, or suppressor-modulated phone transmitters; class-AB audio amplifiers for high-power grid-modulated or for low-power plate-modulated phones, and class-B audio amplifiers for most economical operation of transmitters in which the audio requirements are greater than about 50 watts. Class-AB or class-B modulators require a *driver* stage, which can be considered part of the modulating system proper rather than part of the speech amplifier. The complete modulator essentially consists of a device for converting speech-amplifier output *voltage* into audio *power*.

Complete information on receiver and transmitter type tubes for modulator service, as well as for any other portion of a radiotelephone transmitter, will be found in the chapters which deal with vacuum tubes.

PLATE MODULATION

Plate modulation is the application of the audio modulating power to the *plate circuit* of an r.f. amplifier. The r.f. amplifier must be operated class C for this type of modulation in order to obtain a radio-frequency output which changes in exact accordance with the variation in plate voltage. *The r.f. amplifier is 100 per cent modulated when the peak a.c. voltage from the modulator is equal to the d.c. voltage applied to the r.f. tube.* The positive peaks of audio

voltage increase the instantaneous plate voltage on the r.f. tube to *twice* the d.c. value, and the negative peaks reduce the voltage to zero.

The instantaneous plate *current* to the r.f. stage also varies in accordance with the modulating voltage. The peak alternating current in the output of a modulator must be equal to the d.c. plate current of the class-C r.f. stage at the point of 100 per cent modulation. This combination of change in audio voltage

and current can be most easily referred to in terms of *audio power in watts*.

The plate efficiency of the plate-modulated stage is constant, and the additional power radiated in the form of sidebands is supplied by the modulator.

One of the advantages of plate (or power) modulation is the ease with which proper adjustments can be made in the transmitter. There is less plate loss in the r.f. amplifier for a given value of carrier power than with other forms of modulation, because the plate efficiency is higher.

By properly matching the plate impedance of the r.f. tube to the output of the modulator, the ratio of voltage and current swing to d.c. voltage and current is automatically obtained. The modulator should be *capable* of supplying without distortion audio power to the extent of 50 per cent of the d.c. input to the plate-modulated stage. Complete modulation cannot be secured unless this value of 50 per cent is available, in addition to a coupling system permitting the correct reflected impedance to be obtained.

SPEECH WAVEFORMS

The statement that the average modulator power must be one-half the class-C input for 100% modulation is correct only if the wave form of the modulating power is a *sine wave*. For amateur purposes, where the modulator wave form is speech, the average modulator power for 100 per cent modulation is considerably less than one-half the class-C input. If a modulator is to be used *only with speech*, it seems logical to assume that its design be based upon the peculiarities of speech rather than on the characteristics of the sine wave. The difference between speech and the sine wave is so pronounced that a 100-watt class-B modulator, *if properly designed for speech*, may be used to modulate fully an input of from 300 to 400 watts. The idea cannot be applied to Heising modulators (class-A single-ended) for reasons that will be apparent when it is recalled that such modulators run hottest when resting, and that the plate dissipation limits the peak output as well as the average output.

Power Relations in Speech Waveforms

It has been determined experimentally that speech is equivalent to two simultaneous equal amplitude tones of different frequencies, having a total amplitude equal to that of the sine wave with which the speech is being compared. It follows from this that, for speech, the *average* modulator plate current, plate dissipation and power output are just one-half the sine-wave values for a given *peak* power. In other words a 100-watt class-B modulator, if used to modulate 100 per cent an input of 200 watts, delivers an *average* power of only 50 watts and the average plate current and plate dissipation are only one-half the permissible values. In order to take full advantage of the tube ratings, the design should be altered so that the *peak* power output is increased until the average plate current or plate dissipation becomes the limiting factor.

CLASS-C INPUT THAT CAN BE FULLY SPEECH-MODULATED BY VARIOUS TUBES

Class-B Tubes	Class-C Power Input	Class-B P.P Load	Plate Voltage	Average Speech Plate Current	Class-B Bias	Driver Tubes	Average Driving Power	Driver Transformer Ratio Pri. to 1/2 Sec.
TZ-20	250	4850	750	145	0	2-2A3	7	2.6:1
809	300	4800	750	165	-1 1/2	2-2A3	5	4.5:1
809	400	7200	1000	150	-8	2-2A3	5	4.5:1
TZ-40	500	5100	1000	200	-5	2-2A3	8	2.6:1
TZ-40	600	7400	1250	182	-9	2-2A3	7	2.8:1
203Z	800	5500	1250	250	0	4-2A3	15	2.75:1

Both peak power and average power are necessarily associated with wave form. *Peak* power is just what the name implies, the power at the peak of a wave. Peak power, although of the utmost importance in modulation, is of no practical significance in a.c. power work, except insofar as the *average* power may be determined from the peak value of a known wave form. There is no time element implied in the definition of peak power; peak power may be instantaneous—and for this reason average power, which is definitely associated with time, is the important factor in plate dissipation. It is possible that the peak power of a given wave form be several times the average value; for a sine wave the peak power is twice the average value, and for speech the peak power is approximately four times the *average* value. For 100 per cent modulation the *peak* (instantaneous) audio power must equal the class-C input, although the average power for this value of peak varies widely depending upon the modulator wave form, being 50% for a sine wave and about 25% for speech tones. The problem then of obtaining more speech power consists in obtaining as high a *peak* power as possible without exceeding the *average*

plate dissipation or current rating of the tubes.

Since the power output varies as the square of the peak current, the most logical thing to do in order to obtain high peak power is to increase the peak current. This may be done by decreasing the class-B modulator plate-to-plate load.

At this point it might be assumed that this increase in peak current is nothing more or less than a gross overload without regard for the manufacturer's ratings. However, a little reflection will show that the manufacturer's rating is given as *average* current and that the actual *peak* current (this cannot be read by a meter) varies widely with the mode of operation. An average plate current of 100 ma. in class-C operation may call for a dynamic peak plate current of 1 ampere, whereas in class-B service this same 100 ma. per tube represents a peak of only 315 ma. No ill effects will result if the peak plate current is increased to such a point that the average plate current with speech as read on the plate meter is equal to the sine-wave value as specified by the manufacturer. With this in mind the *peak* plate current may be safely doubled, assuming that the plate dissipation does not become the limiting factor.

BASS SUPPRESSION

Not only can a smaller class-B modulator be used for complete modulation of a given carrier power when voice only is to be used, but an increase in the effectiveness of the modulator power can be obtained by incorporation of a simple bass suppression circuit. Most of the audio power generated in a modulator is represented by the bass frequencies. As the frequencies below 200 or 250 cycles can be greatly attenuated without noticeably affecting the speech intelligibility, it is desirable to do so for communication work. Bass suppression permits a higher percentage modulation at the voice frequencies providing intelligibility, which is equivalent to a substantial increase in power. It is not necessary to suppress the bass frequencies completely; but only to attenuate them until, as the audio gain is in-

creased, overmodulation first occurs at the voice frequencies that afford intelligibility rather than at the power-consuming bass frequencies.

In figures 8 and 9 are shown two simple systems for bass suppression. They are self-explanatory and can be placed between almost any two voltage amplifier tubes in your speech channel. They will work into or out of either triodes or pentodes, but *don't use inverse feedback around the suppressor* or you'll suppress the suppression!

The bass suppressor is an old idea in the talking picture field. It is really surprising how much it cleans up the average boomy ham quality on voice. One reason the new F-type telephone handset mikes sound so good on speech is that they cut off very sharply below 200 cycles.

The bass suppressor shown in figure 8 has a suppression of 6 db at 100 cycles while the arrangement of figure 9 has 0, 4, 6 and 8 db suppression in the four switch positions. The 5-megohm resistors merely eliminate the loud clicks which otherwise would be heard when varying the suppression.

In both of the arrangements, the suppression starts at about 500 cycles although the good work really begins below 200 cycles. The 1000-cycle gain of an amplifier equipped with this type of bass suppression is practically unchanged with the suppressor in or out.

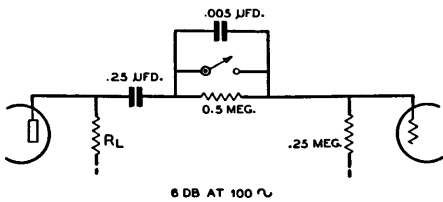

6 DB AT 100 ω
FIGURE 8.

Dialogue Equalizer.

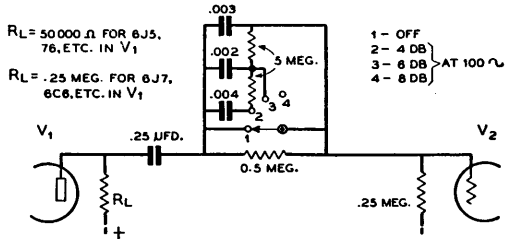

FIGURE 9.

Variable Bass Suppression.

PLATE MODULATION TRANSFORMER CALCULATIONS

The modulation transformer is a device for matching the modulator plate impedance to the impedance of the class-C r.f. amplifier.

The class-C r.f. amplifier impedance is calculated by dividing the d.c. plate-to-filament voltage by the total d.c. plate current. For example, a pair of type 211 tubes, operating at 1200 volts and 300 milliamperes, has a load impedance of 1200 divided by 0.3 amperes, or 4,000 ohms.

$$Z = \frac{E}{I} = \frac{1200}{0.3} = 4,000 \text{ ohms,}$$

where Z is the load impedance of the class-C r.f. amplifier.

The power input is 1200 times 0.3 or 360 watts.

The audio power required for 100 per cent modulation is one-half this value or 180 watts. This power of 180 watts can be supplied by a pair of 203 A tubes (or smaller tubes if only speech modulation is used) in class B with a 1000-volt plate supply. From vacuum tube tables,

it will be found that the load resistance or impedance (plate-to-plate) of class-B 203A tubes should be 6900 ohms.

For maximum power transfer, the 4000-ohm load must be transformed to 6900 ohms. The transformer changes this impedance by using a step-down turns-ratio of 1.3-to-1 total primary to secondary. This ratio is obtained by taking the square root of the impedance

$$\text{ratio} = \frac{6900}{4000}$$

Variable ratio modulation transformers, designed with taps on both primary and secondary, are offered by several manufacturers. The use of such a transformer makes proper matching of the modulator to the class-C modulated stage a simple matter. It should be borne in mind that matching in this sense means reflecting or transforming the class-C load impedance into that value of load impedance into which the modulator tubes are supposed to work for best operation.

HEISING MODULATION

Heising modulation usually consists of a class-A audio amplifier coupled to the r.f. amplifier by means of a modulation choke coil, as shown in figure 10.

The d.c. plate voltage and plate current in the r.f. amplifier must be adjusted to a value which will cause the plate impedance to match the output of the modulator, since the modulation choke gives a 1-to-1 coupling ratio. A series resistor, by-passed for audio frequencies by means of a condenser, must be connected in series with the plate of the r.f. amplifier in order to obtain modulation up to 100 per cent. The a.c. or audio output voltage of a class-A amplifier does not reach a value equal to the d.c. voltage applied to the class-A amplifier and, consequently, the d.c. plate voltage impressed across the r.f. tube must be reduced to a value equal to the maximum available a.c. peak voltage.

A higher degree of distortion can be tolerated in low-power emergency phone transmitters which use a pentode modulator tube for securing sufficient audio output, and thus the series resistor and by-pass condenser are usually omitted.

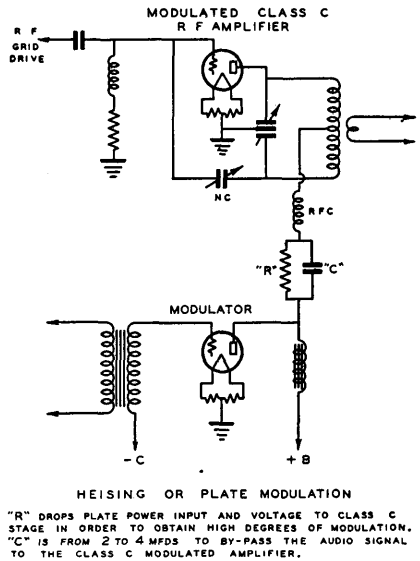

FIGURE 10.

SERIES MODULATION

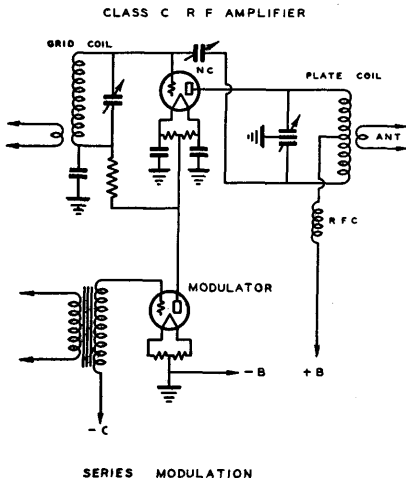

FIGURE 11.

Another form of plate modulation is known as *series modulation*, in which the r.f. tube and modulator are in series across the d.c. plate supply, as shown in figure 11.

Series modulation eliminates the modulation choke required in the usual form of Heising modulation. Although this system is capable of very good voice quality, the antenna coupling must be carefully adjusted simultaneously with the C-bias in the modulator in order to maintain at least 20 per cent more plate voltage across the modulator than that which is measured from positive B to r.f. tube filament. It is difficult to obtain a high degree of modulation unless a portion of the total plate current is shunted by the r.f. tube through a resistor in series with a high-inductance choke coil. Series modulation is seldom used today except for television work.

EFFICIENCY MODULATION

When modulation is effected by a change of r.f. tube plate efficiency, rather than by modulation of plate input power, the system is known as *efficiency modulation*. Control-grid, screen grid and suppressor-grid modulation operate on this principle, as does the class-B linear amplifier stage used by broadcast stations to build up their power *after* modulation.

With pure efficiency modulation, the maximum efficiency at which the r.f. modulated tube can operate is less than 50 per cent, since the peak efficiency (twice the resting value) must be less than 100 per cent. Several methods have been devised for the operation of amplifiers at efficiencies as high as 60 per cent during periods of no modulation. Such amplifiers are rather complicated and difficult of adjustment. This, coupled with the fact that the economy of such amplifiers is confined to high-power operation, limits their practicability to transmitters delivering more than 1 kilowatt of carrier.

Certain forms of grid modulation, while operating on the general principle of efficiency modulation, can be made to release additional power from the d.c. plate supply. These systems are discussed under grid modulation.

Grid Leak Modulation

The several popular forms of grid modulation operate on the same general principle, but under somewhat different conditions. In all systems, the audio-frequency power is impressed upon the grid circuit, and the r.f. amplifier operates in a modified class-C arrangement.

The simplest system employs a vacuum tube as a variable grid leak in a class-C r.f. amplifier with a very small order of excitation. The modulator tube is driven by the speech amplifier, and its plate impedance varies in accordance with the speech input. The modulator tube receives its plate current from the rectified grid current of the r.f. amplifier. The grid bias of the modulator is adjusted to the point which gives best voice quality, and the r.f. excitation must be similarly adjusted for the same purpose. This system, shown in figure 12, does not give distortionless modulation and is critical in adjustment.

Class-BC Grid Modulation

The *Hawkins* class-BC system of grid modulation, shown in figure 13, is a method of grid modulation which can be adjusted to give exceptionally good quality.

The r.f. amplifier is operated with fixed bias equal to cutoff. This bias is supplied either from batteries or from a bias pack. Additional bias is obtained from a cathode resistor R_2 in the modulated stage. This resistor should be bypassed for r.f., but not for audio frequencies, by means of filament by-pass condensers no higher in value than $.005 \mu\text{fd}$.

When an audio voltage is applied from the modulator, it is amplified in the r.f. tube, and degenerative feedback occurs across resistor R_2 . For this reason, the audio power requirements are somewhat greater than for other grid-modulated systems. This degenerative effect, however, produces a very linear modulation characteristic. The d.c. plate current which flows through R_2 should provide an additional bias equal to at least half the theoretical cutoff bias. A higher value of R_2 will result in higher plate efficiency, but at a sacrifice in

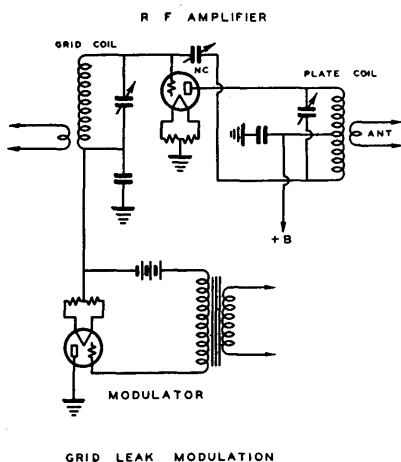

FIGURE 12.

power output, which can be brought up by using higher plate voltage.

The r.f. grid excitation is adjusted to the point where grid current just starts to flow. Excess r.f. grid excitation can be absorbed by resistor R_1 (figure 13) connected across the grid circuit; this resistor also stabilizes the operation of the circuit and improves the quality.

Grid excitation can be conveniently controlled by means of a link-coupling adjustment. The antenna loading is greater than that required for plate modulation or c.w. operation. This coupling should be increased to a point somewhat beyond that at which maximum antenna or r.f. feeder current occurs for given excitation. The plate efficiency will be between 35 per cent and 40 per cent in a well-designed class-BC amplifier.

The circuit constants can be calculated from a group of formulas given here:

- (1) E_b = d.c. plate supply voltage, in volts.
- (2) $W_{plate\ loss}$ = rated plate dissipation of the tube in watts.
- (3) μ = amplification factor of the tube.
- (4) W_{input} = d.c. plate input power, in watts.
- (5) W_{output} = r.f. unmodulated carrier output in watts.

- (6) I_p = d.c. plate current, amperes.
- (7) $E_{c_{c0}}$ = d.c. battery bias equal to theoretical cut-off bias (one-half total bias).

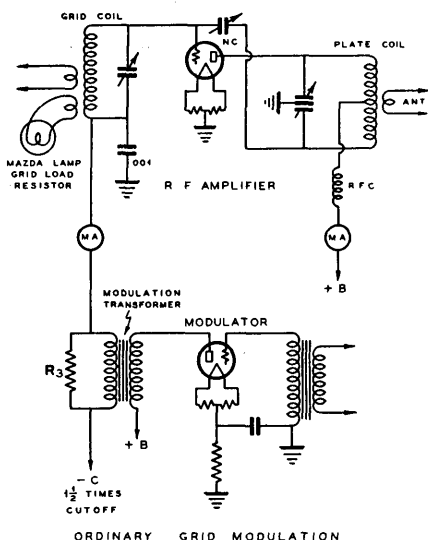

FIGURE 14.

- (8) R_k = cathode bias resistance, in ohms.
- (9) $W_{input} = 1.66 W_{plate\ loss}$
- (10) $W_{output} = .66 W_{plate\ loss}$
- (11) $I_p = \frac{1.66 W_{plate\ loss} (1 + \mu)}{\mu E_b}$
- (12) $E_{c_{c0}} = \frac{E_b}{1 + \mu}$
- (13) $R_k = \frac{E_b^2 \mu}{1.66 W_{plate\ loss} (1 + \mu)^2}$

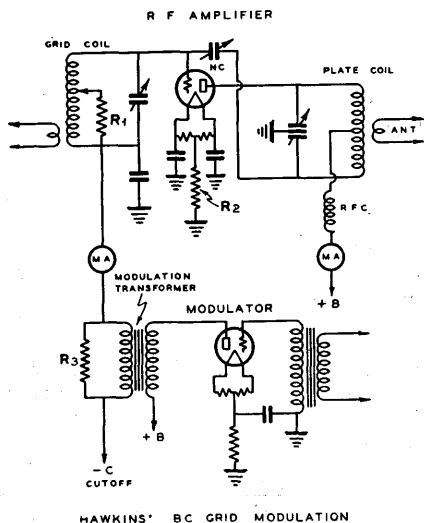

FIGURE 13.

The class-BC amplifier shown for grid modulation can be operated as a linear r.f. amplifier at 40 per cent plate efficiency, which is somewhat better than the efficiency obtainable from a conventional linear amplifier (30 to 33 per cent).

Ordinary Grid Modulation

Probably the most popular form of grid modulation is shown in figure 14.

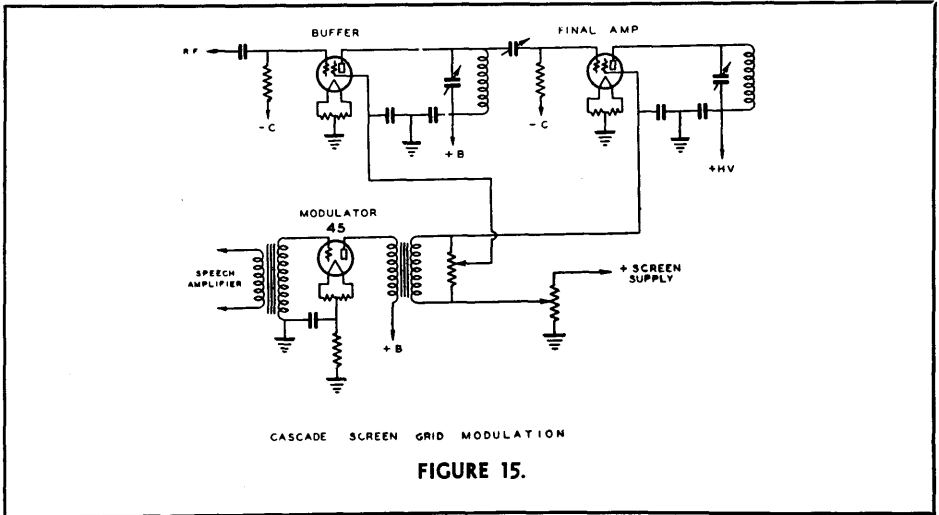

FIGURE 15.

The grid bias is adjusted to $1\frac{1}{2}$ times cutoff, and the r.f. excitation is set to a value which will cause approximately one milliamperes of rectified grid current to flow, as indicated by a d.c. milliammeter. The antenna load is made greater than that required for maximum r.f. antenna current, or increased until linear modulation is obtained, as shown on an oscilloscope or by a phone monitor.

The plate current may increase very slightly during peaks of modulation without objectionable distortion. Good quality modulation up to 90 per cent is easily obtained.

A grid-modulated amplifier can be operated at relatively high efficiencies (about 50%) by running the d.c. grid bias at 3 times cutoff. Rather high r.f. and audio excitation are required. The antenna loading is similar to that of other grid modulation systems. Linear modulation up to values of 90 per cent are obtained, and the system apparently works on the principle of efficiency modulation plus some release of additional plate power from the power supply. The circuit, except for the value of grid bias, is exactly similar to the one shown for ordinary grid modulation.

Modulators for Grid Modulation

The modulator tube for a grid-modulated phone transmitter is relatively small in comparison to the tube required for plate modulation. Grid-

modulated phones with 200 to 400 watts output require an audio power of *less than 15 watts*. This is because modulation takes place in the grid circuit, in which the r.f. power is only a small percentage of that in the plate circuit of the modulated tube.

A small modulator, capable of delivering 2 to 3 watts of audio power, will modulate an r.f. stage which supplies 50 to 100 watts to the antenna circuit. A typical example is shown in one of the transmitters described in the constructional chapters of this book.

The modulator should operate well below its normal output and have a good portion of its output dissipated in a resistor which is connected across the modulation transformer. This resistor is for the purpose of providing a more constant load impedance than that reflected by the grid circuit of the modulated r.f. tube.

The modulator should preferably have a low plate impedance, unless a step-down ratio modulation transformer is available. The a.f. swamping resistor could be eliminated in the case of a type 2A3 tube working into a transformer having a step-down ratio of $1\frac{1}{2}$ -to-1, or 2-to-1. The resistor should be connected across a 1-to-1 transformer when either triode or pentode audio amplifiers are used as modulators. The modulation transformer is suitable for working out of a 2A3 triode or 42 pentode into any grid-modulated r.f. stage in which 50-

or 100-watt tubes are used. The resistor is usually a 10,000-ohm, 2-watt type.

Class-AB output transformers designed for operation from 2A3's or 42 triodes into a 5,000-ohm load are suitable for push-pull modulators. The resistance, in such cases, should be of some value between 7,500 to 10,000 ohms, rated at 10 watts. This push-pull modulator will drive higher power grid-modulated stages, such as a pair of HK354-C's, RCA-806's, Eimac 250TL's, Taylor 814's or Amperex HF-200's.

A phone monitor should always be available for adjusting the r.f. grid excitation to the value which produces the most side-band power consistent with good voice quality. An overmodulation indicator is also essential. The plate circuit of the modulated r.f. tube should have a low impedance to voice frequencies; a 2- to 4- μ fd. filter condenser across the output of the power supply filter will usually suffice.

Modern grid modulation circuits are capable of supplying 500 watts of carrier output from an input of 1 kw. For this higher efficiency, more r.f. drive, more bias and a 35-watt low impedance audio stage (push-pull-parallel 2A3's) are required.

Tubes for Grid-Modulated Phones

Medium- μ triodes are more satisfactory than high- μ tubes for grid-modulated r.f. circuits. Low- μ tubes have the most linear characteristics for this purpose, but the required values of bias voltage are so high that this advantage may be offset by the requirements of higher grid drive. Any screen-grid tube, tetrode or pentode, can be effectively control-grid modulated. The most satisfactory triode tubes for grid modulation are high transconductance, medium- μ tubes having lots of plate dissipation per dollar, such as the T40, 100TL, WE-242A, 211, T200, HF200, HK-354C, 250TL, T814, WE-212-E, 806, etc.

Screen-Grid Modulation

Modulation can be accomplished by varying the screen-grid voltage at an audio-frequency rate in an r.f. screen-grid tube. The screen-grid voltage must be reduced to approximately one-fourth the value of that used for c.w. operation. The r.f. output is correspondingly

reduced and the tube then operates as an efficiency-modulated device, somewhat similar to ordinary grid modulation.

The degree of modulation is limited to approximately 60 per cent when the screen-grid of a single stage is modulated. When two cascade stages are modulated, a level of 100 per cent can be reached, with good quality. The r.f. excitation and screen-grid voltages must be carefully adjusted in order to secure satisfactory results. The r.f. excitation to the grid of the final amplifier must be so low that this tube will act somewhat like a class-B linear stage. It is possible to use dissimilar tubes in the cascade-modulated circuit shown in figure 15.

The buffer amplifier can be a type 807, the final amplifier one or two 814's. In any event, both stages should have the audio modulation voltage applied to the screens. This system of modulation is seldom used because of its complications and because only a few types of tubes are suitable for this application.

Plate and Screen Modulation

When *only* the plate of a screen-grid tube is modulated, it is impossible to obtain high percentage linear modulation, except in the case of certain beam tubes. A dynatronic action usually takes place when the instantaneous plate voltage falls below the d.c. screen

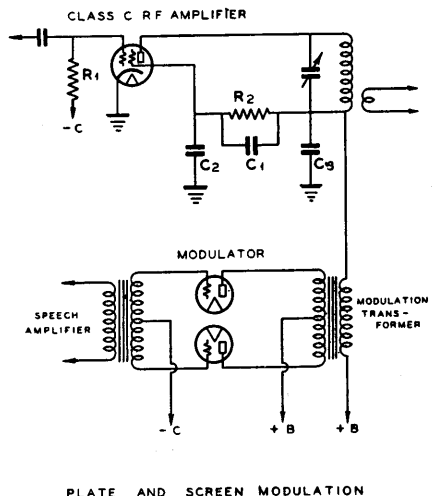

FIGURE 16.

voltage, and this prevents linear modulation. However, if the screen is modulated simultaneously with the plate, the instantaneous screen voltage drops in proportion to the drop in the plate voltage, and linear modulation can then be obtained. A circuit for such a system is shown in figure 16.

The screen r.f. by-pass condenser, C_2 , should not have a value greater than .01 $\mu\text{fd.}$, preferably not larger than .005 $\mu\text{fd.}$ It should be large enough to by-pass effectively all r.f. voltage without short-circuiting high-frequency audio voltages. The plate by-pass condenser can be of any value from .002 $\mu\text{fd.}$ to .005 $\mu\text{fd.}$ The screen-dropping resistor, R_2 , should reduce the applied high voltage to the value specified for operating the particular tube in the circuit. Condenser C_1 is seldom required, yet some tubes may require this condenser in order to keep C_2 from attenuating the high audio frequencies. Different values between .01 and .002 $\mu\text{fd.}$ should be tried for best results.

Another method is to have a third winding on the modulation transformer, through which the screen-grid is connected to a low-voltage power supply. The ratio of turns between the two output windings depends upon the type of screen-grid tube which is being modulated. The latter arrangement is more economical insofar as modulator power is concerned, because there is no waste of audio power across a screen-grid voltage-dropping resistor. However, this loss is relatively small anyway with most tubes. The special transformer is not justified except perhaps for high power.

The modulation transformer for plate-and-screen-modulation, when utilizing a dropping resistor, is similar to the type of transformer used for any plate-modulated phone. In figure 16, the combined screen and plate current is divided into the plate voltage in order to obtain the class-C amplifier load impedance. The audio power required to obtain 100 per cent sine-wave modulation is one-half the d.c. power input to the screen, screen resistor and plate of the modulated r.f. stage.

Quite good linearity at high percentage modulation can be obtained with some of the beam-type transmitting tetrodes by modulating the plate voltage alone.

If the screen voltage for the beam tube is derived from a dropping resistor (*not* a divider) that is by-passed for r.f. but not a.f., it is possible to secure quite good modulation up to about 90% by applying modulation only to the plate, provided that the screen voltage and excitation are first run up as high as the tube will stand safely. Under these conditions the screen tends to modulate itself to an extent, the screen voltage varying over the audio cycle as a result of the screen impedance increasing with plate voltage, and decreasing with a decrease in plate voltage.

Suppressor Modulation

Still another form of efficiency modulation can be obtained by applying audio voltage to the suppressor-grid of a pentode tube which is operated class C. A change in bias voltage on the suppressor-grid will change the r.f. output of a pentode tube, and the application of audio voltage then provides a very simple method of obtaining modulation.

The suppressor-grid is biased negatively to a point which reduces the plate efficiency to somewhat less than 40 per cent. The peak efficiency at the time of complete modulation must reach twice this value. It is difficult to obtain 100 per cent modulation, though 90 per cent to 95 per cent can easily be obtained and with good linearity. Adjustments are more easily made than with control-grid modulation, and the type of audio modulator and the values of audio voltage are approximately the same as for ordinary grid modulation. The same modulator design problems apply to suppressor-modulated phones. The control grid in the suppressor-modulator stage is driven to about the same degree as for c.w. or plate modulation. The r.f. excitation adjustment is not critical, but the excitation should be ample to allow distortionless modulation in this stage.

The quartz crystal should not be placed directly in the grid circuit of any suppressor-modulated stage because of a tendency for frequency modulation and because of poor quality due to insufficient r.f. grid excitation. A simple test with an oscilloscope will prove the fallacy of using a suppressor-grid modulated pentode as a crystal oscillator in order to

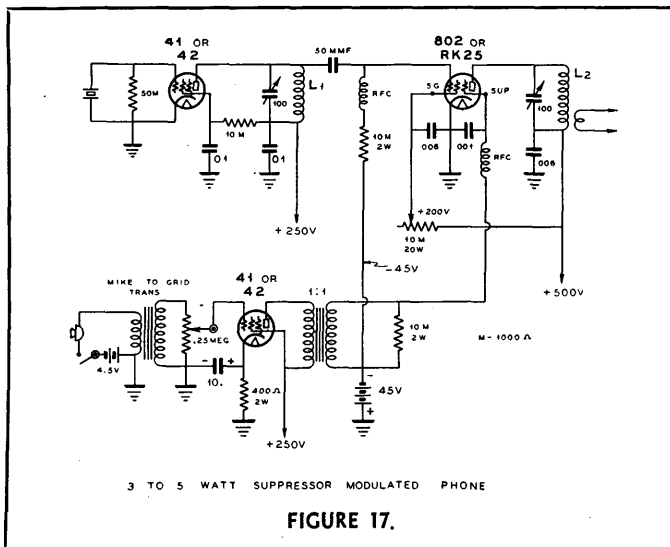

FIGURE 17.

minimize the number of stages in the transmitter.

One of the smallest and most simple suppressor-modulated phone transmitter circuits is shown in figure 17.

The output of this transmitter is satisfactory for local communication in the 10- and 160-meter bands.

A separate crystal oscillator is incorporated in order to secure better quality of modulation. A 250,000-ohm gain control may be required in the pentode modulator circuit if a sensitive single-button carbon microphone is used. The modulation transformer should be of the type designed for class-B input service, 1-to-1 or 2-to-1 step-down ratio. When a 2-to-1 ratio transformer is used, the 10,000-ohm loading resistor across the secondary should be reduced to about 5,000 ohms.

The suppressor-grid should be bypassed with a condenser not larger in value than $.001 \mu\text{fd.}$ in order to prevent loss of high audio frequencies. The screen-grid resistor of the modulated tube should be adjusted to a value which will give 200 volts between screen and cathode during normal operation.

The output can be doubled by merely putting another tube in parallel with the 802 and using a 5000-ohm grid leak instead of the 10,000-ohm one shown. No other changes are necessary.

All pentode r.f. tubes can be easily over-excited, resulting in decreased out-

put. The amount of excitation, while not critical, should be checked with a d.c. milliammeter in the grid leak circuit of the modulated stage. The grid current should run between 4 and 6 milliamperes. The antenna loading should be adjusted so that the plate current is between 20 and 30 milliamperes at resonance. Over-modulation, due to excessive audio input, can be checked with an overmodulation indicator. The peak audio voltage need not be more than 65 or 75 volts.

Suppressor-modulated phone transmitters should not be too heavily loaded by the antenna if linear modulation is desired. The degree of loading is comparable to that for a class-C plate-modulated stage.

It is desirable to place a metal shield around the screen-grid tube; this shield should extend from the base to about halfway up the glass envelope. Plate and grid circuits should be well shielded.

A higher power suppressor modulated phone circuit is shown in figure 18. This transmitter uses an 804 pentode tube. The modulator is quite similar to the one shown in the preceding transmitter circuit. The peak audio voltage for complete modulation is the same as for the smaller tubes. Slightly more grid drive is required from the crystal oscillator or exciter, which may be either link- or capacitively-coupled to the modulated stage. The same exciter as shown for the 802 transmitter, but with from 300

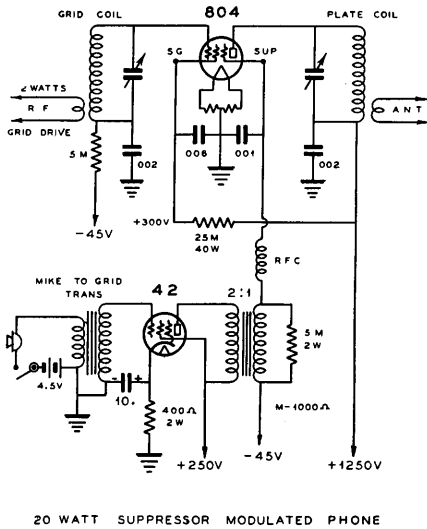

FIGURE 18.

to 350 volts on the plate of the oscillator tube, will give ample excitation to drive the 804. The oscillator screen resistor should be increased to 30,000 or 40,000 ohms in order to keep the screen voltage of the crystal oscillator below 125 volts.

An RCA-803 pentode may be suppressor-modulated for carrier outputs of from 50 to 60 watts. The r.f. excitation depends upon the frequency of operation, but can be supplied by a 6L6 crystal oscillator or doubler. A type 45 or a 42 pentode will serve as a modulator for either tube.

It is possible to operate a suppressor-modulated stage as a doubler. The efficiency suffers somewhat, but the quality is about as good as when working on the fundamental.

CONTROLLED CARRIER RADIOTELEPHONY

One way in which the operating efficiency of a class-B r.f. linear amplifier can be improved is by the use of *carrier control*, in which the amplitude of the carrier wave is proportional to the voice frequency *envelope*. About twice as much peak power can be obtained from a linear amplifier with carrier control than when constant carrier is applied to the linear amplifier.

The principle of the system is the use of only enough carrier power to accommodate the actual side-band power that is being transmitted at the moment. This variation in carrier amplitude can be accomplished by a number of different methods. One is to use a saturable reactor in series with the modulated stage, another is to vary the average suppressor

voltage on a suppressor-modulated stage, and another is to vary the control bias on a control-grid modulated stage. In all these cases, the control voltage is taken from a rectifier and amplifier system that is connected to the speech circuit of the transmitter.

The system has some advantages, but for amateur work the advantages are largely outweighed by the disadvantages. In the first place, it is difficult to eliminate the time-lag that is introduced by the control system. The existence of this lag has a tendency to allow the first syllable of each wave train to over-modulate the transmitter. Another disadvantage of the system is that the varying carrier affects the a.v.c. circuit of a receiver tuned to it.

INVERSE FEEDBACK

Inverse feedback or *degeneration* allows improved operation of audio amplifiers or radio transmitters. It has been found that the proper application of degeneration in an amplifier can be made to reduce greatly the harmonic

distortion and otherwise improve the fidelity. Inverse feedback causes a reduction in amplifier gain, which can be offset by the addition of a stage of audio amplification in the speech amplifier. This disadvantage is more than off-

set by the reduction in three kinds of distortion, known as frequency distortion, nonlinear distortion and delay or phase distortion.

Inverse Feedback Principle

The principle involved in inverse feedback systems is to select a portion of the amplifier output voltage and feed it back into one of the previous circuits, exactly out of phase with the input voltage. In figure 19, a simple method of applying inverse feedback to an audio amplifier is shown. With the values of resistance as indicated, the reverse feedback is approximately 10 per cent. This reduces the gain of the audio amplifier; however, it still has approximately twice the sensitivity of a triode amplifier with similar plate circuit characteristics. The plate circuit impedance of the 6L6 is greatly reduced, an advantage when working into a loudspeaker (because a loudspeaker is not a constant impedance device).

Inverse feedback can be applied in a somewhat different manner, as shown in figure 20, for a two-stage amplifier. This method is particularly desirable, in that feedback produces better results when the feedback circuit is connected from the output back to the grid of one of the preceding amplifier stages.

The polarity of the secondary winding of the output transformer, in all cases where the feedback connection is made to the secondary, should be that which

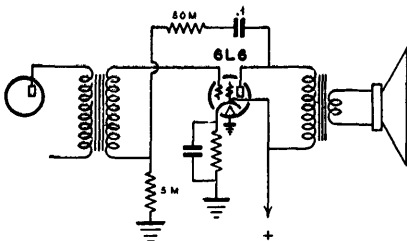

INVERSE FEEDBACK FOR SINGLE STAGE AMPLIFIER

FIGURE 19.

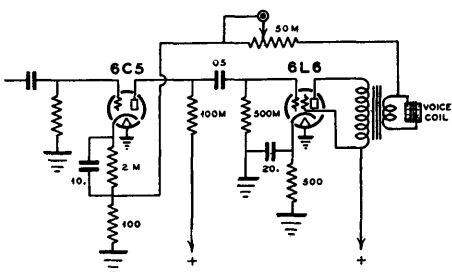

INVERSE FEEDBACK FOR 2 STAGE AMPLIFIER

FIGURE 20.

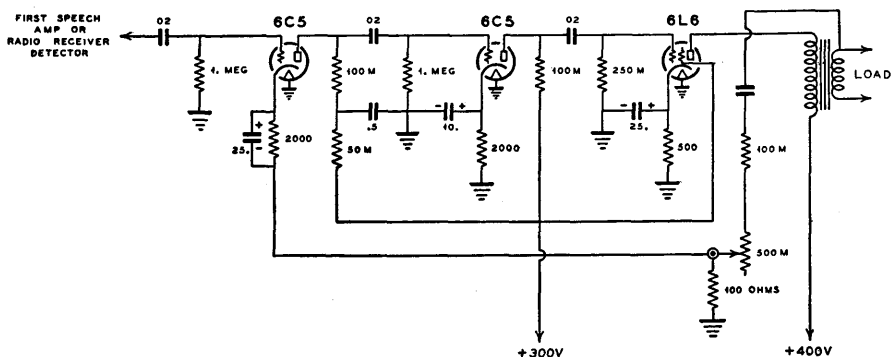

DEGENERATIVE FEEDBACK AMPLIFIER

FIGURE 21.

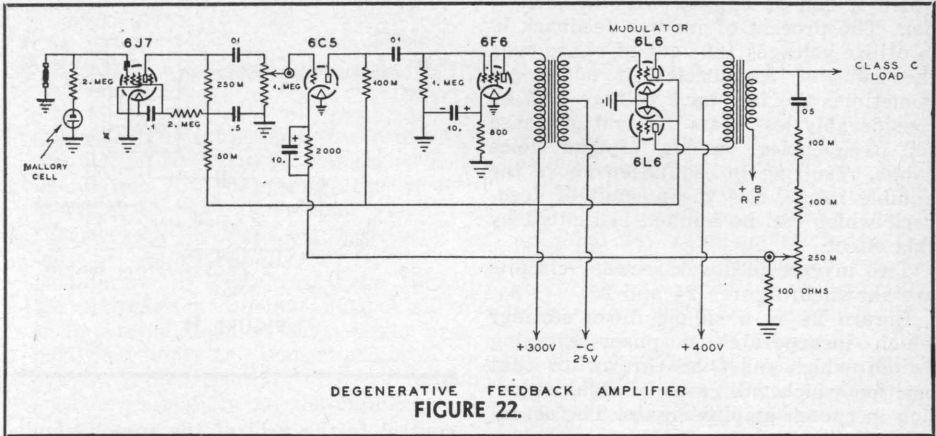

The circuits in figures 21 and 22 indicate methods for applying inverse feedback to three stages of amplification. These two systems are suitable for operation as speech amplifiers and modulators for grid-modulated radiotelephones, or low-power plate-modulated transmitters. The 100-ohm cathode resistor should be located as near as possible to the 6C5 tube cathode terminal in order to prevent undesirable pickup and feedback at frequencies other than those desired.

R. F. Inverse Feedback

Modulation distortion, noises and hum

level which are present on the carrier of a radiotelephone station can be reduced by inverse feedback applied as in many broadcast transmitters, but modified for amateur applications. The method consists of rectifying a small amount of the carrier signal and feeding back the audio component in reverse phase into some part of the speech amplifier. This arrangement will reduce the hum level and improve the voice quality of most amateur radiotelephone transmitters.

The amount of inverse feedback that can be applied in this manner will depend upon the available amount of excess speech amplification and the degree to

Figure 23. A neatly-constructed speech amplifier incorporating all worthwhile innovations, such as optional bass suppression, optional treble suppression, inverse feedback, peak limiting and universal dual-channel mixing is a worthwhile investment in a medium- or high-power phone transmitter, as the cost of the amplifier represents only a fraction of the total investment and such an amplifier can contribute greatly to the effectiveness of the transmitter.

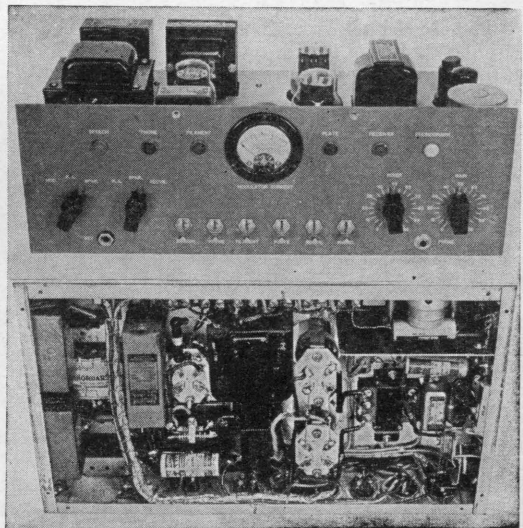

which it can be carried without oscillation. The process of inverse feedback is to utilize voltages 180° out of phase over the band of frequencies of operation. Sometimes the feed-back voltage may be considerably less than 180° out of phase for frequencies outside of the voice range, resulting in oscillation above the audible range, and the amount of feed-back which can be applied is limited by this effect.

Two inverse feedback rectifier circuits are shown in figures 24 and 25.

Figure 24 is a simple diode rectifier which incorporates a phase-reversing switch which must be thrown to that position which will cause a slight reduction in speech amplifier gain. The actual gain of the speech amplifier can be increased by means of the manual gain control. The undesired noise or hum which is audible in the phone monitor will generally be reduced with the correct adjustment of the r.f. pickup coil and phase-reversing switch. Once adjusted, no additional changes are necessary unless the transmitter power output or frequency is varied.

In figure 25, a type 84 rectifier tube is connected so that one side serves as an inverse feed-back rectifier, and the other side is a standard overmodulation indicator and phone monitor.

The circuits in figures 26 and 27 show methods of connection from the feed-back rectifier into the speech amplifier.

Feedback Rectifier Diode

The feed-back rectifier diode rectifies the carrier, and any hum or noise modulation on the carrier appears as an audio voltage across the 100,000-ohm feed-back

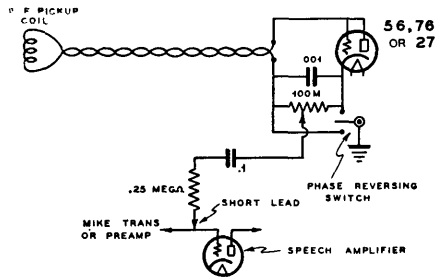

FIGURE 24.

control to the grid of the speech amplifier. A portion of this voltage is fed back into the speech amplifier so as to be out of phase, and thus buck out the hum or noise in the output of the radio transmitter. This may actually introduce distortion in a portion of the speech amplifier in which there is otherwise none present, but the final result is that the distortion or hum is cancelled out in the carrier signal of the radiotelephone transmitter. This system may be applied to transmitters which use plate, suppressor or control grid modulation.

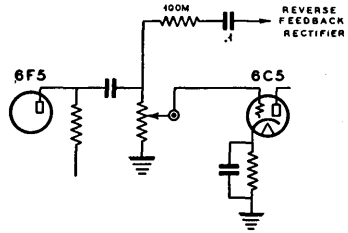

FIGURE 26.

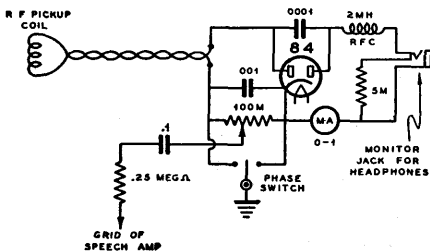

FIGURE 25.

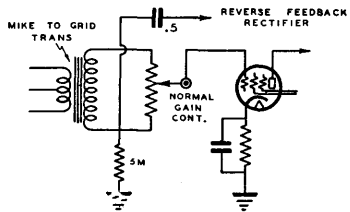

FIGURE 27.

A. F. PEAK LIMITERS; AUTOMATIC MODULATION CONTROL

It is possible to increase the average modulation level without danger of overmodulation by designing the speech amplifier to have a nonlinear amplification above a threshold value corresponding to approximately 80 per cent modulation. In other words, the gain of the amplifier is constant until a signal is impressed upon it that would ordinarily modulate the transmitter over 80 per cent; then the gain of the amplifier goes down rapidly as the input signal is increased.

To increase the modulation percentage in a conventional transmitter from 80 per cent to 100 per cent requires an increase in the input signal of 2 db. Broadcast stations commonly employ a compressor or peak limiter which requires 5 db increase in the audio input voltage to the amplifier in order to raise the modulation from 80 to 100 per cent. This gives 3 db compression and permits running of the gain control, without danger of overmodulation, at a setting 3 db higher than would other-

wise be possible. This is equivalent to doubling the transmitter power.

Somewhat more than 3 db compression can be employed in a voice transmitter designed for communication work, but an attempt to incorporate too much compression will result in distortion so great as to affect the intelligibility.

Automatic modulation control is similar to a peak-limiting audio amplifier in effect, though the method of accomplishing the compression is somewhat different. In the a.m.c. system the output of the modulator itself is used to actuate the compression circuit, and it is somewhat more positive in action and easier to adjust. The chief disadvantage of the latter system is that it can be used only with plate modulation, while a peak-limiting a.f. amplifier can be used with either plate modulation or any type of grid modulation.

Practical application of peak-limiting and a.m.c. systems will be found in the chapter on radiotelephony construction.

RADIOTELEPHONY POWER SUPPLIES

A power supply for a radiotelephone transmitter should furnish nonpulsating d.c. voltage to the crystal oscillator or other source of frequency control. The amount of pulsation or ripple voltage should be less than 1 per cent of the d.c. voltage, especially for radio transmitters operating on very high frequencies. Hum or ripple voltage in the plate supply to the oscillator will frequency-modulate the r.f. output slightly. Each frequency multiplier stage increases the frequency modulation, until the carrier hum becomes objectionable in high-frequency transmitters. Many amateur 10-meter phones suffer from this difficulty, noticed especially with selective receivers.

The power supply for the front end of the speech channel must be thoroughly filtered in order to avoid amplification of the ripple in the succeeding audio or

speech amplifier stages. The plate supply for the final audio amplifier stage does not require as much filter as the preceding stages, and, in the case of a push-pull audio modulator stage, a single-section filter will suffice.

Buffer stages of a control-grid modulated transmitter must have very well-filtered plate supplies (more than the buffers in a plate-modulated transmitter) in order to prevent hum modulation in the grid circuit on which the speech audio frequencies are impressed. On the other hand, the plate supply for the grid-modulated stage itself does not require quite as much filter as does a comparable plate-modulated stage. This indicates that a single-section filter will suffice for a grid-modulated stage, whereas a two-section filter is desirable for plate modulation. In the event that only a single-section filter is used for a

grid-modulated stage, condenser input is desirable. A single-section choke input filter does not furnish sufficient ripple suppression except for a c.w. amplifier or push-pull (or push-push class-B) modulator stage.

Class-B Modulator Voltage Regulation

Power supply voltage regulation of class-B modulators is of great importance because the plate current varies appreciably with the amount of speech input. Choke input, utilizing preferably a *swinging-choke* with high no-current inductance rating (25 hy. or more) and low d.c. resistance, in conjunction with

mercury vapor rectifiers and a husky filter condenser (at least 4 μ fd.) will make a good power supply. If the resting plate current of the modulator tubes is high, as is the case with some of the zero bias, class-B tubes, a swinging type choke is not essential; however, even so, the choke should have high inductance (10 or 20 hy.).

A comparatively high degree of ripple as compared to a modulated amplifier power supply can be tolerated in a power supply feeding a push-pull audio or modulator stage, because a good percentage of the hum is cancelled out in the coupling transformer if the modulator tubes are well matched.

TROUBLE SHOOTING

Feedback, Hum and Distortion in Speech Amplifiers

Great care is necessary in the design of speech amplifiers in order to prevent hum, distortion and feedback at radio- or audio-frequencies. Certain precautions can be taken in building the speech amplifier, as related here: (1) Shield all low-level grid and plate leads. (2) Avoid overheating the shielded wires (rubber insulation) when soldering ground connections to the shield. (3) Shield all input and microphone connections. (4) Wire the filaments with twisted conductors. (5) Mount resistors and condensers as near as possible to socket terminals. (6) Orient the input and low-level audio transformers in a position of minimum hum when a.c. power is applied to the primaries of the power supply transformers. (7) Shield the input and low-level stage tubes. (8) Use a good ground connection to the metal chassis (water-pipe or ground rod connection). (9) Ground all transformer and choke coil cores. (10) Use metal cabinets and chassis, rather than breadboard construction. (11) By-pass low-level audio stage cathode resistors with a .002- μ fd. mica condenser for the purpose of preventing rectification of stray r.f. energy which will sometimes produce hum.

The power supply for a speech amplifier should be exceptionally well filtered. This may require three sections of filter,

consisting of three high-capacity condensers and two or three filter chokes. When space permits, the power supply should be placed several feet from the speech amplifier.

The speech amplifier and microphone leads should be completely shielded for the elimination of r.f. feedback. A concentric or a *balanced* two-wire r.f. transmission line to a remotely located antenna is the most effective method of preventing r.f. feedback into the microphone or speech amplifier circuits in the range of from 5 to 20 meters.

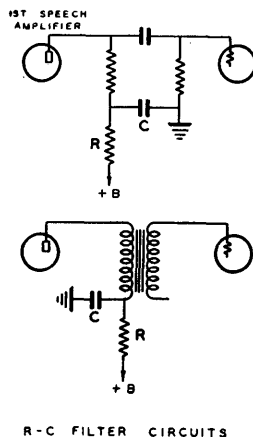

FIGURE 28.

The impedance of ground leads at such short wavelengths makes it impossible completely to eliminate stray r.f. currents. End-fed antennas and single-wire fed systems are particularly troublesome with respect to r.f. feedback.

Audio feedback may cause motor-boating, whistling or howling noises in the audio amplifiers. Insufficient by-pass capacity across the plate supply of a multistage speech amplifier is one cause of motor-boating. The first stage of a speech amplifier should have a resistance filter in its plate supply lead, which may consist of a 10,000- to 50,000-ohm 1-watt resistor in series with the positive B lead, with a $\frac{1}{2}$ - μ fd. condenser connected to ground from the amplifier side of the series resistor. (See figure 28.)

A defective tube will introduce hum or

distortion, as well as affect the overall gain or power output of an audio amplifier. Incorrect bias on any amplifier stage will produce harmonic distortion, which changes the quality of speech. This bias voltage should be of the correct value for the actual plate-to-cathode voltage, rather than the plate supply output voltage (these may be widely different in a resistance-coupled stage). Excessive audio input to any amplifier stage will produce amplitude distortion. Incorrect plate coupling impedances or resistances will cause distortion. A damaged or inferior microphone is another source of distortion. Cathode resistors should be by-passed with ample capacity to provide a low impedance path for the lowest frequencies. Push-pull and especially class B amplifiers require balanced tubes.

AUDIO OUTPUT BLOCK DIAGRAMS

From the group of block diagrams here shown, the reader quickly can find a satisfactory tube complement for audio outputs ranging from 1.5 watts to 1,000 watts. The *legend* explains the various connection systems shown in the block diagrams; diaphragm type crystal or carbon microphones or preamplifier are denoted by the conventional symbol, shown directly below the *legend*. High output dynamic or equivalent type microphones may be used where the crystal microphone symbol appears. Correct operating plate voltages are shown under the tube symbols in each diagram. The arrow to the far right denotes the audio output of the amplifier. Outputs are listed in the respective order of the diagrams, beginning with the lowest (1.5 watts) and ending with the highest (1,000 watts).

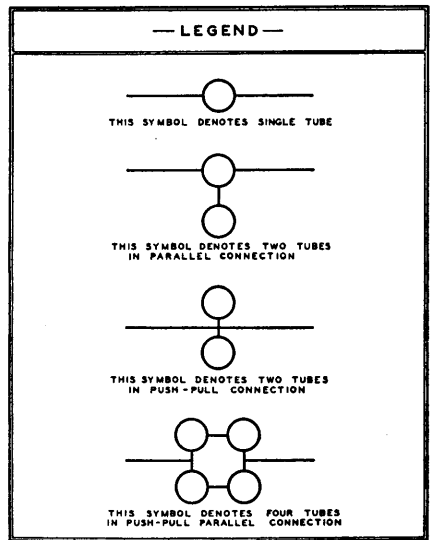

Carbon Microphone or Preamplifier.



Crystal Microphone or Equivalent.

370 RADIO Handbook

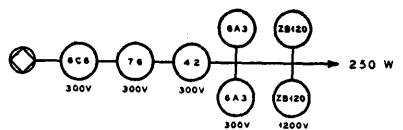
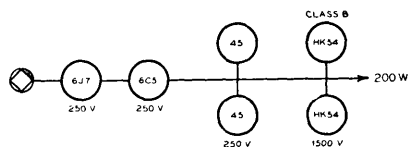
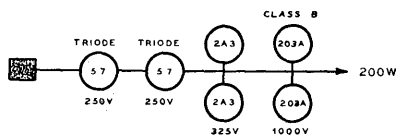
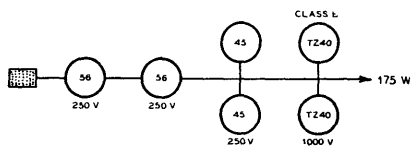
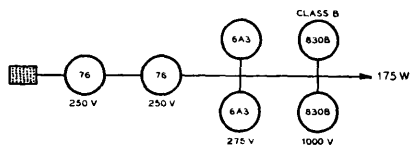
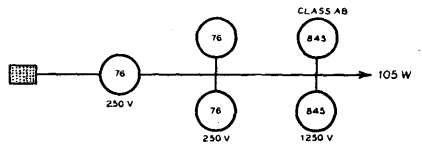
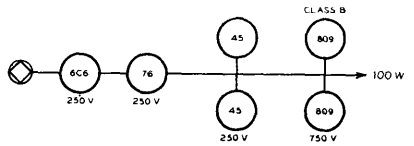
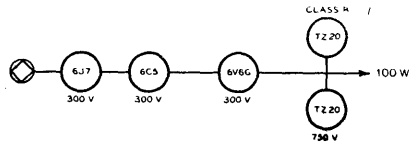
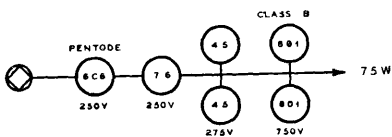
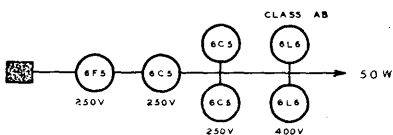
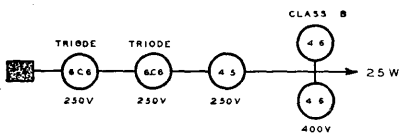
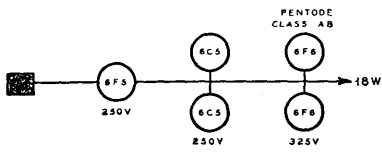
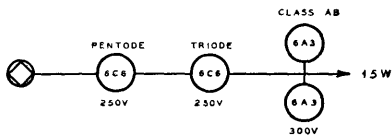
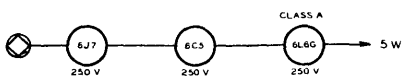
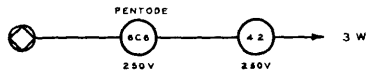
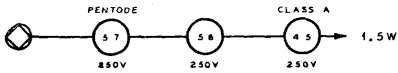

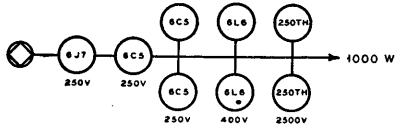
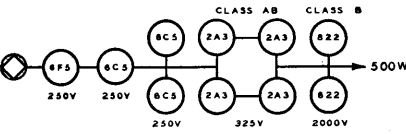
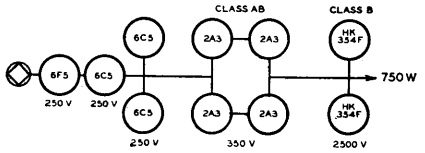
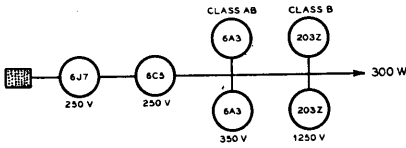
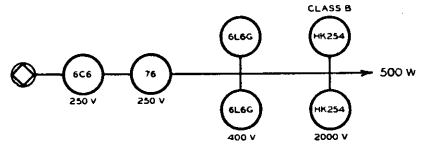
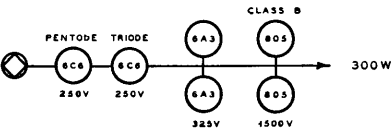
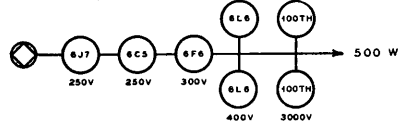
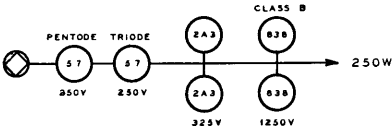
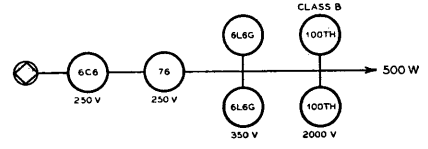
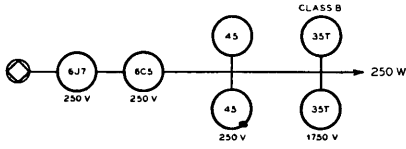

CHAPTER 15

Radiophone Transmitter Construction

R. F. Sections and Power Supplies—Construction of Grid and Plate Modulators—Design Details

THIS chapter includes detailed information on the design, construction and operation of several modern radiotelephone transmitters of various power outputs, for operation in any of the commonly used amateur frequency bands. All of these transmitters are in actual operation at amateur stations. They include new but proved circuit improvements, and they are presented because they are representative of the type of equipment most universally chosen by the typical radio amateur.

Principal Considerations

The principal considerations in the design of an economical radiophone transmitter are the choice of the correct combinations of tubes and circuits so that the desired amount of power output and good voice quality can be secured with a minimum of components.

The components in the audio channel must be so chosen and arranged as to reduce the hum level to a minimum; the r.f. circuits must be free from parasites; the LC tuning ratios must be correct, and there must be a total absence of frequency modulation, instability, carrier shift, overmodulation or undermodulation. All of these requirements were carefully considered in the design of the transmitters shown in this chapter.

Radiophone transmitter construction must take into consideration the proximity of power supply equipment to the audio frequency transformers or low-level grid leads. Any chokes or transformers in the low-level audio stages

should be mounted as far as possible from power transformers and input filter chokes, which have relatively large surrounding a.c. fields. The audio transformers and coupling chokes can be properly oriented on the chassis before the holes are drilled for their mounting. A pair of headphones should be connected across the winding of each audio transformer or choke; 110-volts a.c. is then supplied to the primaries of all power transformers, and the audio transformer or choke is then rotated to determine the center of the hum "null." It should be bolted to the chassis in this position even if it detracts from the neatness of the amplifier.

Some manufacturers offer special hum-bucking transformers for use in low-level audio stages; the transformers are so wound that they need not be specially oriented for minimum hum pickup.

Especially care need not be taken with high-level audio transformers such as class-B input and output transformers if they are well-shielded and are not mounted too close to any power transformers.

Resistance Coupling

Use of resistance coupling in the low-level audio stages of a speech amplifier makes it unnecessary to take precautions against inductive hum pickup, but grid and plate leads should be shielded to prevent electrostatic pickup, resulting in a.f. feedback and hum pickup.

A separate ground lead from the speech amplifier to an external ground is strongly advisable when the speech

An r.f. amplifier that is to be modulated should be constructed with considerable care to insure good voice quality. The 100TH push-pull 10-, 20- and 75-meter amplifier illustrated here is an example of excellent mechanical design. The grid and plate circuits are effectively shielded, avoiding any possibility for regeneration and consequent nonlinearity. A carrier output of 200 watts with grid modulation or 400 watts with plate modulation is readily obtainable if suitable auxiliary equipment is used. For grid modulation, 100TL's are slightly preferable to 100TH's, and the tank condensers need not have as much spacing as for plate modulation.

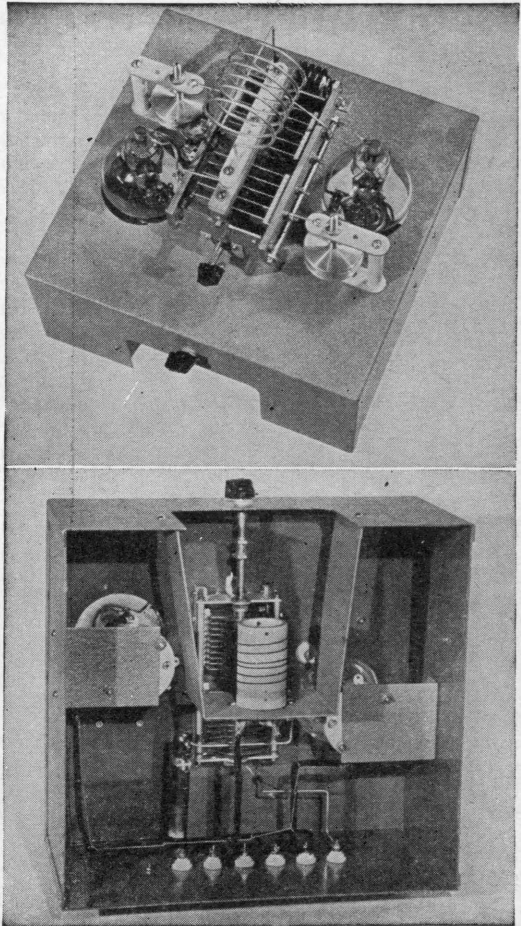

amplifier is not integral with the rest of the transmitter. With relay construction, in which the rack frame constitutes a common ground for both r.f. and audio units, a heavy copper bus run as direct as possible to a good external ground will suffice.

As mentioned at the beginning of the c.w. transmitter construction chapter, the final r.f. amplifier in a radiophone transmitter must be constructed with more care than an amplifier used exclusively on c.w. The final amplifier should be linear if good voice quality is to be obtained. For plate modulation this means at least twice cutoff bias, abundant excitation, absence of regeneration and proper tank circuit Q. The latter consideration is covered thoroughly in chapter 11.

At the end of this chapter are shown a

speech amplifier-driver incorporating peak-limiting, another incorporating a.m.c., and a combined a.m.c. speech amplifier and modulator capable of modulating fully a plate input of 500 watts to a class-C stage. These units are described for the benefit of the amateur who wants to put his c.w. transmitter on phone or replace an antiquated speech amplifier or modulator with one of modern design. The two amplifier-drivers can be used either for grid modulating a medium-power r.f. stage or for driving a class-B modulator of the reader's choice. The TZ-40 unit can be used to plate-modulate on speech any half-kilowatt input amplifier that neutralizes perfectly and has sufficient bias and excitation for class-C operation, and otherwise meets the requirements set forth above.

ECONOMICAL 160-M. PHONE TRANSMITTER

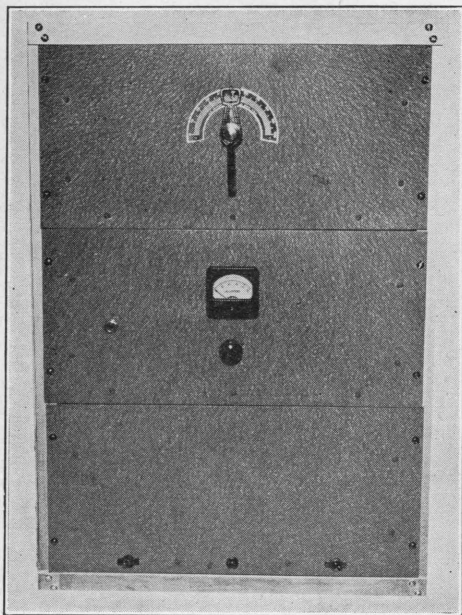

Figure 1. The front of this 30-watt 160-meter phone transmitter presents a pleasing appearance by virtue of its very simplicity. The transmitter is very easy to construct and adjust, and is recommended for the newcomer interested in phone operation.

The 160-meter radiophone transmitter illustrated in the accompanying photographs and diagrammed in figure 3 was designed expressly for the newcomer whose license does not permit phone operation on the class-A bands. By confining operation to the one band, considerable saving in components is effected, and excellent efficiency and performance can be obtained at minimum cost.

After the amplifier is once neutralized, only one tuning adjustment is required. This makes correct adjustment a simple matter and facilitates changing of frequency within the band. The transmitter is crystal-controlled, delivers over 30 watts of fully-modulated carrier and incorporates an automatic overmodulation limiter of the peak compression type (a.m.c.).

A simple Pierce crystal oscillator, which has no tuned circuits, has suffi-

cient output to drive a pair of parallel 6L6G's, which are plate-screen modulated by a pair of push-pull 6L6's in class AB. The latter are driven by a 6K7 voltage amplifier and 6C5 driver, the combination having sufficient gain to work from a diaphragm type crystal microphone. A single heavy-duty 400-volt power supply handles the whole transmitter.

The automatic modulation control system allows the use of a higher gain setting without danger of overmodulation than would be the case if the device were not incorporated. This effectively increases the range of the transmitter, being equivalent to an increase in power.

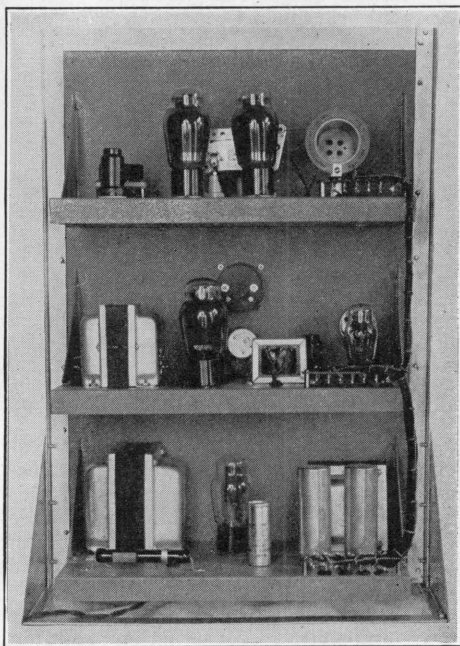

Figure 2. Back view of the 30-watt 160-meter phone transmitter. The r.f. unit, speech system and power supply are constructed on metal panels from which are supported metal chassis as illustrated. A hardwood rack can be used to support the panels if a suitable metal one cannot be obtained or if the required metal tools for construction of a metal rack are not available.

When the negative a.f. modulation peaks exceed the voltage of the plate supply, the 56 diode rectifies this voltage and feeds it as an a.v.c. voltage to the 6K7 suppressor grid. An increase in the negative suppressor voltage reduces the gain of the 6K7, thus effectively retarding overmodulation. A 22½-volt positive bias on the diode allows it to start operating before 100% modulation is reached.

The modulated amplifier stage uses a husky b.c.l. tuning condenser of the type manufactured some years ago and available from most radio service men or repair shops for about 25c if you do not have one in the junk box. The condenser should have at least .025" air gap and

good insulation. The center-tapped plate tank coil consists of 30 turns of no. 16 enamelled wire, spaced on a 2½"-diameter form to cover 3 inches. The neutralizing condenser consists of a small mica trimmer with the adjusting screw removed, as the correct adjustment will usually occur with the plates spaced approximately 3/32".

Oscillation of the crystal oscillator can be checked by touching a ¼- or ½-watt neon bulb against the plate terminal. The neutralizing condenser should be adjusted until tuning of the 6L6G plate tank condenser through resonance does not affect the brilliancy of the neon bulb when held against the plate terminal of the oscillator. This should be done with

FIGURE 3. SCHEMATIC DIAGRAM OF THE 30-WATT 160-M. PHONE TRANSMITTER.

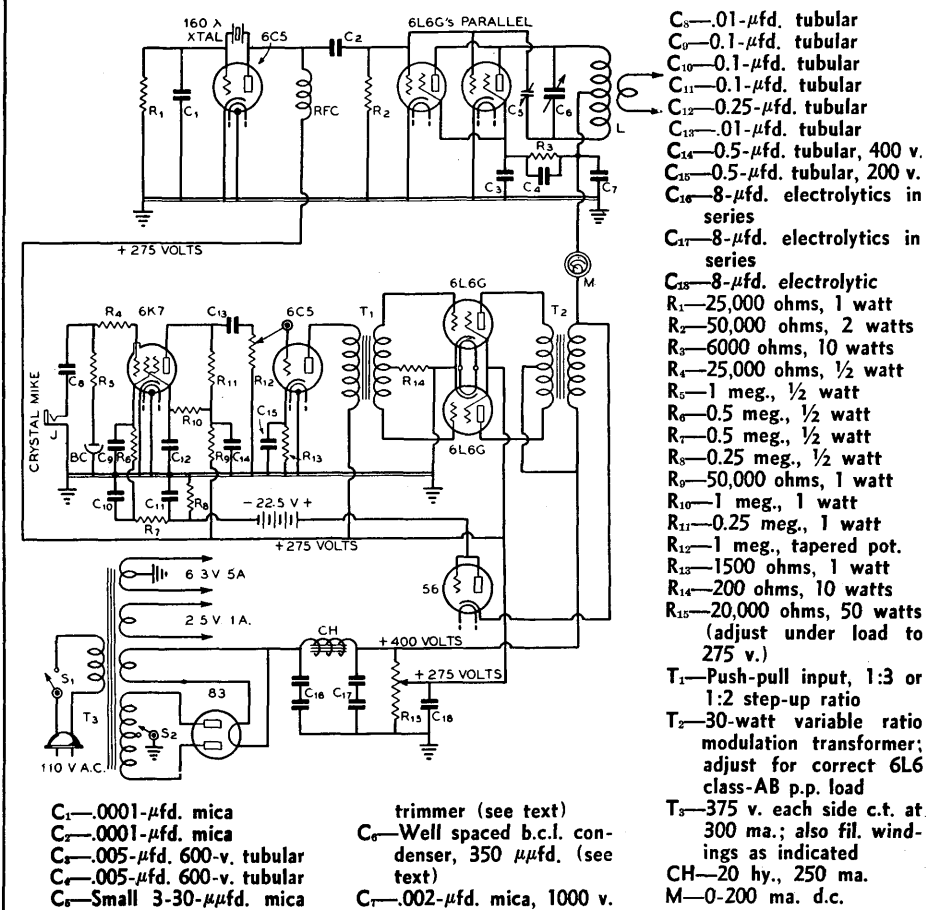

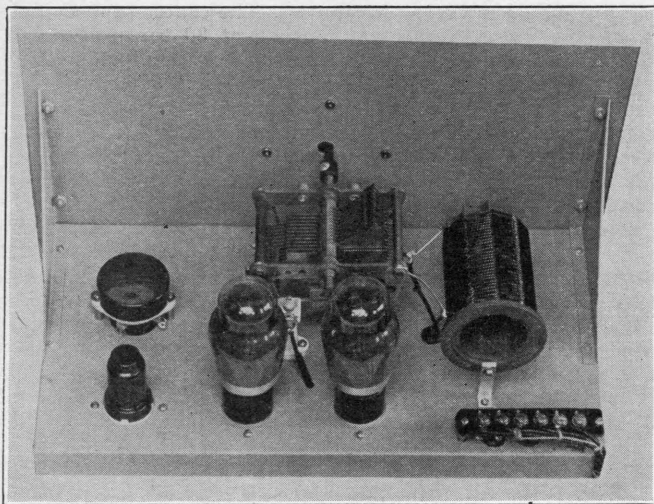

Figure 4. The complete r.f. section occupies one chassis.

the plate voltage removed from the 6L6G amplifier.

The antenna should be inductively coupled to the plate coil by means of sufficient turns of insulated wire wound over the center of the coil to result in a 130-ma. load at resonance, which is indicated by minimum plate current as the plate tank condenser is rotated. In other words, the amplifier should be loaded until it dips to 130 ma., and then

tuned to the bottom of the dip. This plate current will result in a carrier power of over 30 watts.

The whole transmitter can be built into a small, homemade rack with metal panels as illustrated, or contained in a metal cabinet of the type used for factory-built communications receivers. In either case, a coat of grey wrinkle-finish lacquer greatly enhances the appearance. Panels are 8"x17"; chassis, 8"x15"x1".

ECONOMICAL 10-160 M. GRID-MODULATED PHONE

The 50-watt grid-modulated phone transmitter illustrated in figures 5 and 6 will deliver over 50 watts of carrier for phone operation, with excellent voice quality and high percentage modulation. For c.w. operation, over 100 watts output is obtainable on any band. The complete r.f., a.f. and power units are all on one chassis, making the transmitter easily transportable.

A regenerative 6L6G harmonic oscillator drives a pair of T-40's in push pull, which are grid-modulated by a 6V6. A single power supply serves for the whole transmitter.

The harmonic oscillator is of the type discussed in detail in the exciter chapter. It works well with 10- to 160-meter crystals and can be used for second harmonic operation when regular cut crystals are used. Special harmonic-type

high-frequency crystals, which themselves oscillate on a harmonic, can be used only for fundamental operation in this particular exciter circuit. The oscillator is inductively coupled to the push-pull T-40 grids by means of an untuned, center-tapped coil. Excitation adjustment, essential for correct tuning of a grid-modulated transmitter, is accomplished by means of a five-point rheostat, consisting of a tapped dropping resistor and a selector switch.

In spite of the fact that no buffer stage is used, there seems to be little reaction of the modulating voltage upon the oscillator frequency, as no objectionable frequency modulation can be detected on any band.

The use of fixed inductive coupling between the two r.f. stages makes it necessary to change only two coils when changing bands. The T-40 plate coil is

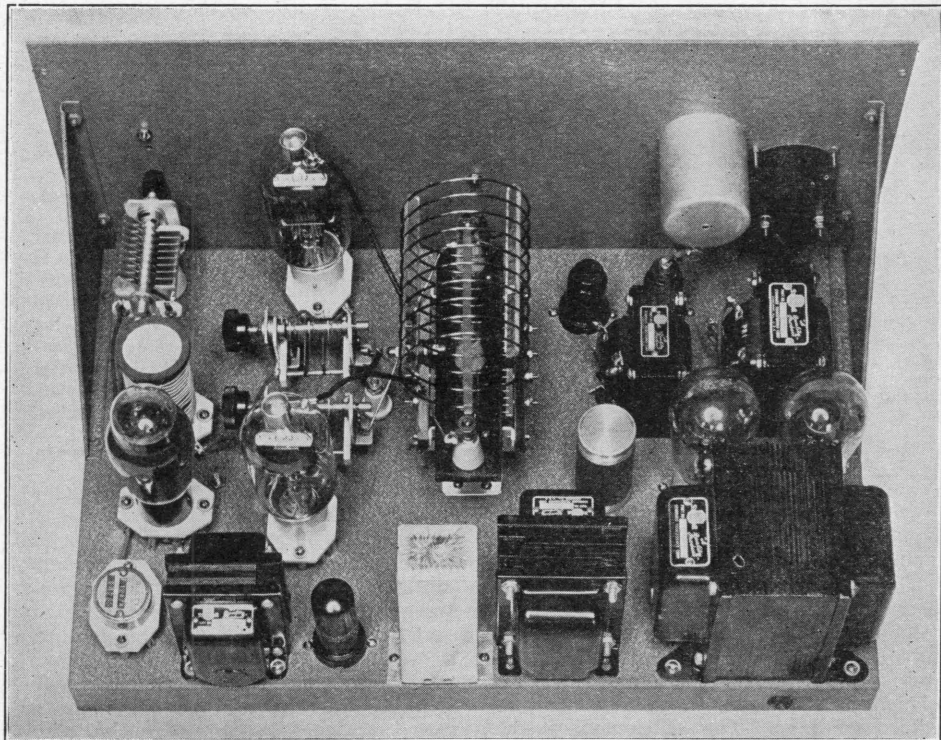

Figure 5. This 50-watt phone or 100-watt c.w. transmitter is entirely self-contained and works on all bands from 10 to 160 meters. A pair of push-pull T-40's are grid-modulated by a 6V6. One power supply feeds the whole transmitter.

always tuned to the frequency of the oscillator plate coil, regardless of whether the oscillator coil is tuned to the frequency of the crystal or to the second harmonic. With extremely active 40-meter crystals, it is possible to quadruple in the oscillator and obtain sufficient 10-meter drive for 10-meter operation of the amplifier. Likewise some 80-meter crystals can be used to quadruple to 20 meters. However, not all crystals are sufficiently active for quadrupling in the oscillator and can be used only for fundamental or second harmonic output.

The speech system consists of two voltage amplifier stages, designed to work from a diaphragm-type crystal microphone and a 6V6 output stage or modulator. Inverse feedback is used to lower the plate impedance of the 6V6 modulator and make it less sensitive to the variable load offered by the grids of the T-40's under modulation.

Because little voltage swing is required from the 6V6, a single-button

microphone has sufficient output to drive the 6V6 directly, through a suitable microphone transformer. Hence, for operation with a single-button microphone, the first two audio stages may be omitted. C_1 and R_{11} in the grid of the 6V6 should be left in the circuit when omitting the first two stages, unless it develops that sufficient gain is not obtainable with the particular single-button microphone used. In the latter event, the inverse feedback can be omitted, with an increase in gain. However, most single-button microphones have sufficient output when run from a 4½- or 6-volt battery that the inverse feedback may be left in the circuit, with an improvement in voice quality.

A single heavy-duty 800-volt power supply furnishes high voltage to the whole transmitter. This makes for compactness, simplicity and economy. Bleeders and dropping resistors lower the high voltage to values appropriate for the oscillator and speech stages. Used

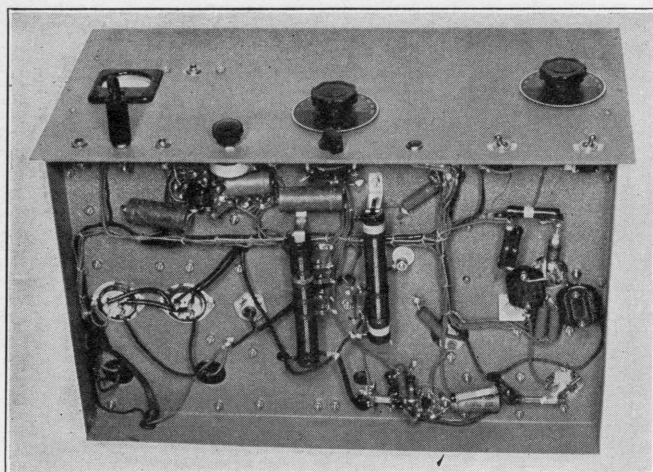

Figure 6. Showing front panel and underside of the T-40 phone-c.w. transmitter diagrammed in figure 7. Note the scarcity of tuning controls. The one meter reads both grid and plate current to the r.f. tubes.

in conjunction with filter condensers, the dropping resistors also provide hum filtering and decoupling.

The d.c. grid bias value for the T-40's is not critical; any value from 45 to 90 volts is satisfactory. More bias will require more r.f. and a.f. excitation. The quality is practically the same, but the efficiency is slightly higher with high values of bias. The efficiency of the modulated stage will run around 50% for any value of bias over 45 volts. This

efficiency permits a phone carrier of approximately 50 watts on 10 meters and 55 or 60 watts on the lower frequency bands. By using extremely heavy loading and running over 200-ma. plate current to the T-40's, it is possible to obtain 75 watts of fully modulated carrier with good voice quality. However, this value of plate current exceeds the manufacturer's rating on some of the power supply components, and they will overheat if allowed to run very long overloaded.

For normal operation, the 6L6G cathode current will run between 15 and 50 ma., depending upon the frequency and upon the setting of the excitation control rheostat. The grid current to the T-40's should be increased by means of the excitation control until about 4 ma. flows when the T-40's are drawing 175-ma. cathode current. About 3-ma. grid current will be found optimum for loading of the T-40's to 150 ma., and about 6-ma. grid current will be found correct for 200-ma. cathode current to the T-40's. To draw this much cathode current at such low values of grid current, quite close antenna coupling must be used, tighter than for c.w. operation. If too much excitation is supplied for a given loading of the T-40's, it will be impossible to obtain a high percentage of modulation without distortion. The heavier the T-40's are loaded, the more excitation can be run to them.

For c.w. operation the excitation control should be run wide open and the T-40's loaded to approximately 200- or 215-ma. cathode current. Keying can be

T-40 TRANSMITTER COIL DATA

BAND	OSCILLATOR PLATE	GRID	FINAL PLATE
10	4½ turns #18 d.c.c. 1½" diam. 1¼" long	5 turns #24 d.c.c. 1½" diam. center tap closewound at lower end of plate coil	4 turns #10 enam. 2¾" diam. 4" long center tap
20	10 turns #18 d.c.c. 1½" diam. 1¼" long	9 turns #24 d.c.c. 1½" diam. center tap closewound at lower end of plate coil	10 turns #14 enam. 2¾" diam. 4" long center tap
80	32 turns #22 d.c.c. 1½" diam. closewound	36 turns #26 d.c.c. 1½" diam. center tap closewound at lower end of plate coil	34 turns #14 enam. 2¾" diam. 4" long center tap
160	70 turns #26 enam. 1½" diam. closewound	70 turns #30 enam. 1½" diam. center tap closewound at lower end of plate coil	70 turns #18 d.c.c. on 2¾" diam. tubing 4" long center tap

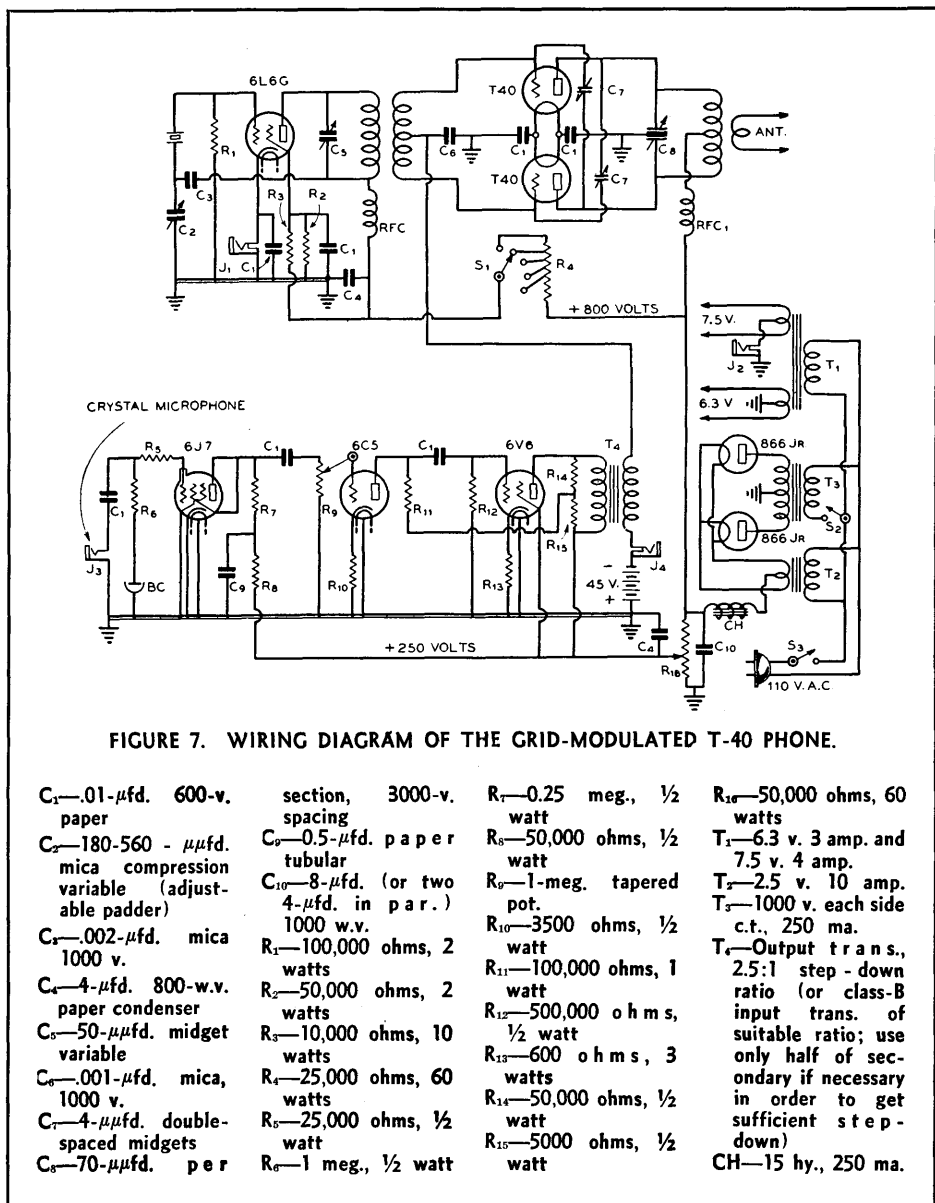

accomplished in the cathode of the 6L6G oscillator. Because of the intermittent input during keying, it is possible to exceed the power supply rating slightly in the interest of greater output; the power supply will not overheat unless the key is held down for long periods.

The transmitter illustrated was built on a chassis 19"x12"x1 3/4" with a front panel 10"x20". The transmitter could just as well be built into a commercially-manufactured cabinet if of suitable size. In any event, it is wise to follow the parts layout illustrated.

75-WATT 10-160 M. PLATE MODULATED PHONE

The radiophone transmitter illustrated in the accompanying photographs and diagrammed in figure 10 can be used either for phone or c.w. on any band from 10 to 160 meters with an output of at least 75 watts. It is constructed rack and panel style with the plate-modulated final amplifier occupying the top deck; the r.f. exciter, the second deck from the top; the speech system and a 325-volt power supply, the next deck, and a 400-volt and a 600-volt power supply, the bottom deck.

Output can be obtained on one, two or four times the crystal frequency. The

crystal oscillator is a conventional triode type, running at low voltage, and using cathode bias. This drives a 6L6G which can be used either as a link-neutralized straight buffer on 75 meters, or as a doubler on 160. The 6L6G excites a capacitively-neutralized 809 which can be run either as a doubler or straight neutralized amplifier. The 809 drives a pair of the same tubes in push-pull, which are plate-modulated at about 100-watts input. As the 809's are rated for zero-bias operation (static) at 600 volts, no fixed bias is required to protect them from oscillator failure or during keying of the oscillator or one of the buffers.

The speech system is designed to work from a diaphragm type crystal microphone or microphone of equivalent output level, and starts out with a 6D6 whose suppressor is connected to an automatic modulation control system in the manner of a delayed a.v.c. system. The 6D6 feeds another voltage amplifier, a 76 triode, which feeds a triode-connected 42 driver stage. The 6L6G's are run class AB₂ with fixed battery bias, and are used with a 1:1 ratio output transformer. Under these conditions they will deliver without distortion over

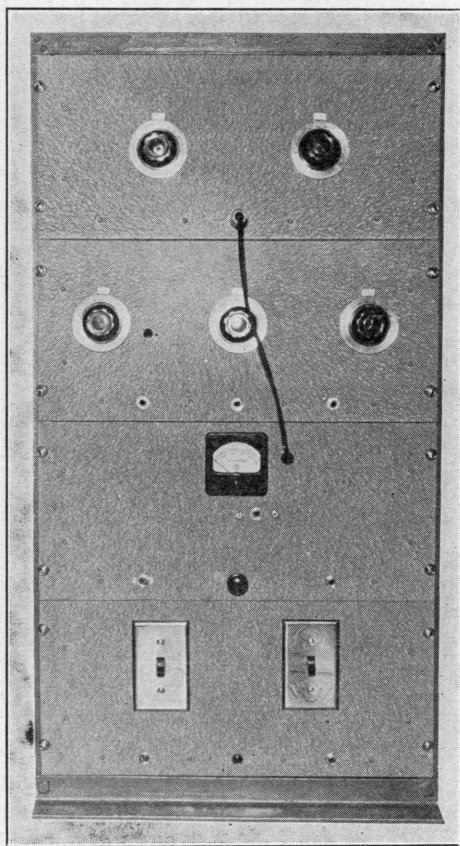

Figure 8. This neat rack-and-panel 75-watt phone uses a pair of 809's in the final amplifier, plate-modulated by a pair of 6L6G's in class AB.

809 PHONE TRANSMITTER COIL DATA

BAND	6J5G AND 6L6G	809 BUFFER & FINAL GRID	FINAL PLATE
160	65 turns #24 d.c.c. 1½" diam. closewound	68 turns #22 d.c.c. 2¼" diam. closewound center tap	44 turns #14 ¼" diam. 4" long center tap
80	34 turns #22 d.c.c. 1½" diam. 1½" long	38 turns #22 d.c.c. 1½" diam. 1½" long center tap	32 turns #14 2¾" diam. 4" long center tap
40	15 turns #16 enam. 1½" diam. 1¼" long	20 turns #16 enam. 1½" diam. 1½" long center tap	20 turns #14 2¾" diam. 4" long center tap
20	7 turns #16 enam. 1½" diam. 1" long	10 turns #16 enam. 1½" diam. 1¼" long center tap	10 turns #14 2½" diam. 4" long center tap
10		4 turns #16 enam. 1½" diam. 1" long center tap	6 turns #12 2" diam. 4" long center tap

50 watts of audio, more than sufficient for full modulation of the input to the class-C amplifier.

Any value of delay voltage may be applied to the 6H6 cathode by adjusting R_{2a} . The setting of this potentiometer determines the point (percentage modulation) at which the automatic modulation control begins to function. The a.m.c. system allows the use of a relatively high average level of modulation on speech without danger of over-modulation on occasional loud voice peaks. The system acts as a volume compressor, but does not work until the modulation reaches a certain level, depending upon the setting of the delay potentiometer.

Inspection of figure 10 shows all meter jacks in the cathode circuits rather than in the plate leads. This means that the grid current must be subtracted from the cathode current reading to determine the actual value of plate current for that stage. With this system, all meter jacks are at ground potential and there is no danger of shock when taking readings.

The 6L6G r.f. stage is neutralized on 160 meters by means of a one-turn loop around the cold ends of both oscillator and 6L6G plate coils. The position and orientation (polarity) of one of the loops is varied until the 6L6G shows no tendency to oscillate. This can be accomplished by removing the crystal and adjusting one of the neutralizing loops until no grid current flows to the 809 buffer. On other bands the 6L6G is ordinarily operated as a doubler, and hence requires no neutralization. However, it can be link-neutralized on 75 meters if fundamental operation with a 75-meter crystal is desired.

On 160 meters it is desirable not to load the modulated amplifier to more than about 150 or 175 ma. cathode current, in order to provide a more desirable value of Q . If a 150 $\mu\text{mfd.}$ per section tuning condenser is used rather than the one indicated and the 160-meter coil turns are reduced to resonate with the condenser nearly meshed, full input (rated plate current) can be run on 160 meters.

Construction

The transmitter utilizes four $8\frac{3}{4} \times 19$ " relay rack panels. The associated chas-

sis all measure $10 \times 17 \times 1\frac{3}{4}$ ", and have end brackets to provide sufficient strength for support from the front panels.

The final tank coil is mounted on plugs and jacks above the final tank condenser, thus providing very short leads. Either ceramic or low-loss bakelite forms may be used for the 809 plate coil. Regular ribbed bakelite forms are suitable for the oscillator and 6L6G plate coils.

Shield partitions measuring 6×8 " are placed on either side of the 6L6G stage as illustrated in order to insure stable operation when working "straight through"; the shields effectively elimin-

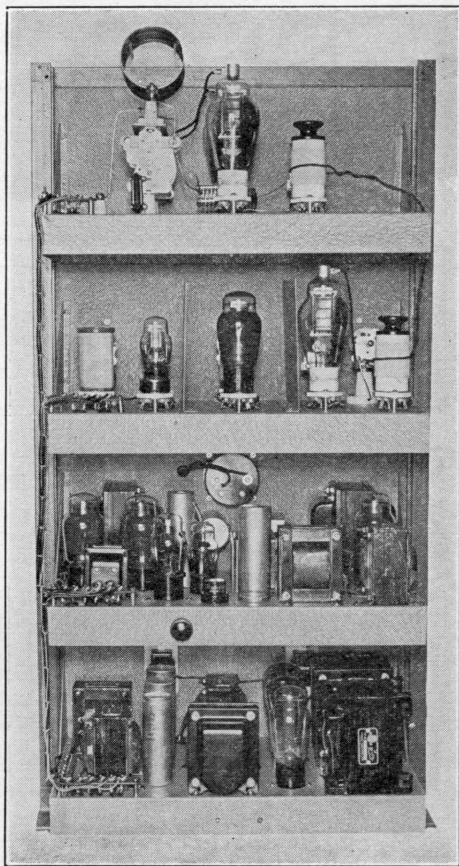

Figure 9. Back view of the 75-watt 809 transmitter. The four decks are, top to bottom: modulated push-pull amplifier, exciter, speech amplifier-modulator and 325-volt power supply, 400-volt and 600-volt power supplies.

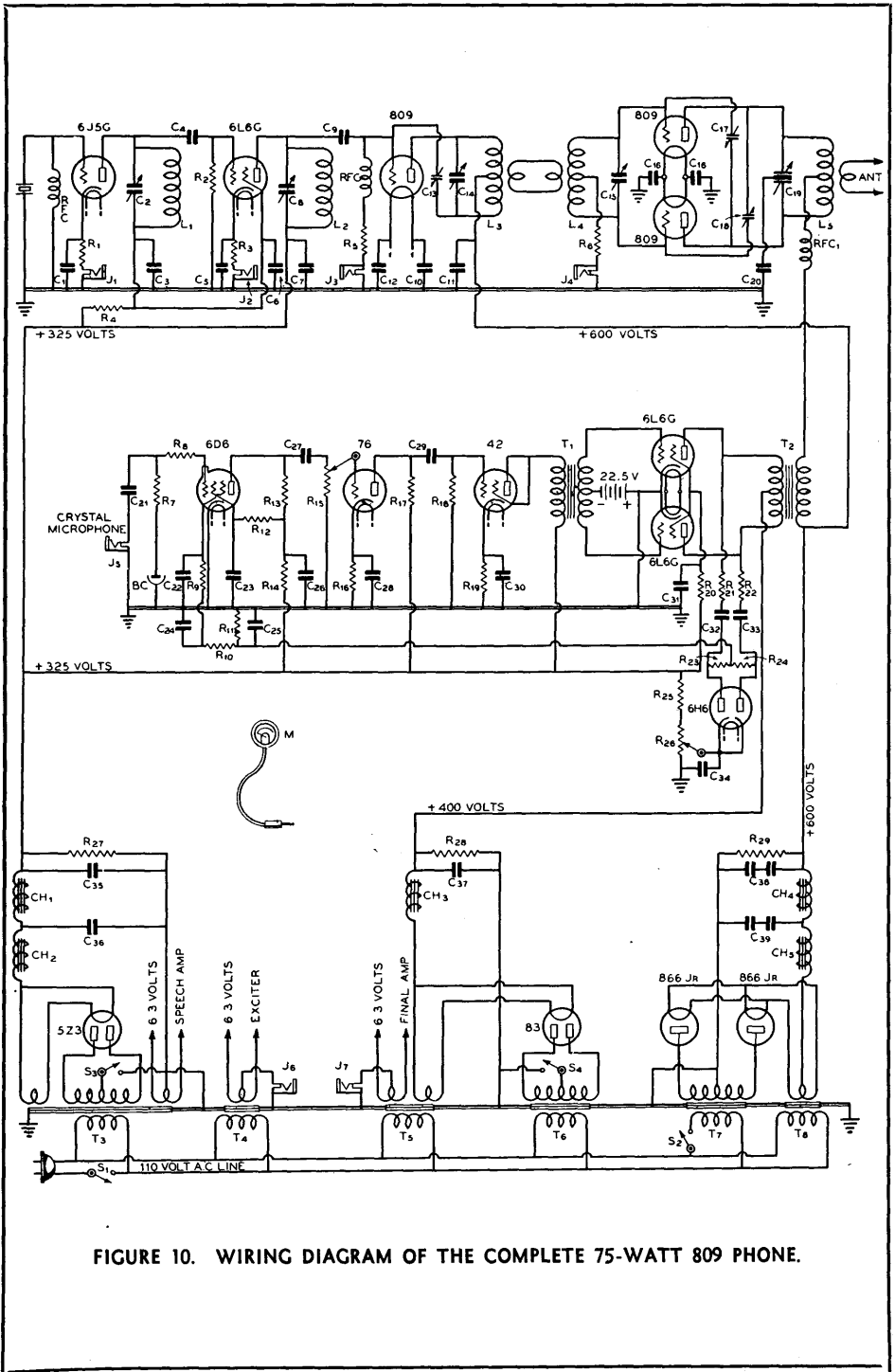

FIGURE 10. WIRING DIAGRAM OF THE COMPLETE 75-WATT 809 PHONE.

Figure 11. The push-pull 809 final amplifier is laid out for symmetry and short leads. The 809's run at 600 volts and are plate-modulated for phone.

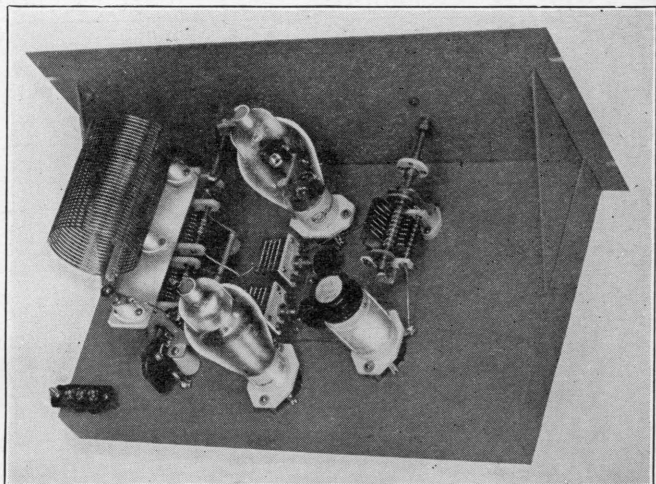

FIGURE 10. CONSTANTS FOR THE WIRING DIAGRAM OF THE 75-WATT 809 PHONE.

C ₁ —0.1- μ fd. tubular	C ₂₅ —0.1- μ fd. tubular, 400 v.	R ₁ —1 meg., 1/2 watt	RFC ₁ —2.5-mh. 250-ma. r.f. choke
C ₂ —100- μ fd. mid-get	C ₂₆ —0.25- μ fd. tubular, 400 v.	R ₂ —25,000 ohms, 1/2 watt	T ₁ —Class-AB input
C ₃ —0.1- μ fd. tubular	C ₂₇ —0.1- μ fd. tubular, 400 v.	R ₃ , R ₁₀ , R ₁₁ —250,000 ohms, 1/2 watt	T ₂ —Variable match 50-watt modulation trans. or class-AB 6L6 output trans. with 3500-ohm, 175-ma. sec.
C ₄ —50- μ fd. mica	C ₂₈ —0.5- μ fd. tubular, 200 v.	R ₁₂ —1 meg., 1 watt	T ₃ —400 v. each side c.t., 150 ma., and fil. windings indicated
C ₅ , C ₆ , C ₇ —0.1- μ fd. tubular	C ₂₉ —0.1- μ fd. tubular, 400 v.	R ₁₃ —250,000 ohms, 1/2 watt	T ₄ —6.3 v. 4 amp.
C ₈ —50- μ fd. midget	C ₃₀ —10- μ fd. 2.5 - v. electrolytic	R ₁₄ —50,000 ohms, 1/2 watt	T ₅ —6.3 v. 5 amp. and 5 v. 3 amp.
C ₉ —50- μ fd. mica	C ₃₁ —0.1- μ fd. tubular, 400 v.	R ₁₅ —1-meg. tapered pot.	T ₆ —500 v. each side c.t., 200 ma.
C ₁₀ —0.1- μ fd. tubular	C ₃₂ , C ₃₃ —0.1- μ fd. tubular, 1000 v.	R ₁₆ —2500 ohms, 2 watts	T ₇ —750 v. each side c.t., 200 ma.
C ₁₁ —0.002- μ fd. mica	C ₃₄ —0.5- μ fd. tubular, 200 v.	R ₁₇ —100,000 ohms 1 watt	T ₈ —2.5 v. 5 amp., 1500-v. insulation
C ₁₂ —0.1- μ fd. tubular	C ₃₅ , C ₃₆ —8- μ fd. electrolytics, 450 v.	R ₁₈ —1 meg., 1/2 watt	CH ₁ —8-30-hy. swinging choke, 250 ma.
C ₁₃ —8 μ fd. max., double spaced	C ₃₇ —8- μ fd. electrolytic, 600 v.	R ₁₉ —1000 ohms, 10 watts	CH ₂ —15 hy. 250 ma.
C ₁₄ —50- μ fd. double-spaced midget	C ₃₈ , C ₃₉ —8- μ fd. 600-v. electrolytics in series	R ₂₀ —2000 ohms, 2 watts	CH ₃ —8-30-hy. swinging choke, 250 ma.
C ₁₅ —50- μ fd. double-spaced midget	R ₁ —200 ohms, 2 watts	R ₂₁ , R ₂₂ —250,000 ohms, 1 watt	CH ₄ —15 hy. 250 ma.
C ₁₆ —0.1- μ fd. tubular	R ₂ —100,000 ohms, 2 watts	R ₂₃ , R ₂₄ —100,000 ohms, 1 watt	CH ₅ —8-30-hy. swinging choke, 250 ma.
C ₁₇ , C ₁₈ —8- μ fd. double-spaced midgets	R ₃ —300 ohms, 10 watts	R ₂₅ —100,000 ohms, 2 watts	CH ₆ —15 hy. 250 ma.
C ₁₉ —100 μ fd. per section, double spaced (.05" or greater air gap)	R ₄ —5000 ohms, 10 watts	R ₂₆ —50,000 ohms pot.	COILS—See coil table
C ₂₀ —0.02- μ fd. mica, 1000 v.	R ₅ —5000 ohms, 10 watts	R ₂₇ , R ₂₈ —25,000 ohms, 35 watts	
C ₂₁ —0.1- μ fd. tubular, 400 v.	R ₆ —2500 ohms, 35 watts	R ₂₉ —25,000 ohms, 50 watts	
C ₂₂ —0.1- μ fd. tubular, 200 v.		RFC—2.5-mh. 125-ma. midget chokes	
C ₂₃ —0.1- μ fd. tubular, 400 v.			
C ₂₄ —0.1- μ fd. tubular, 400 v.			

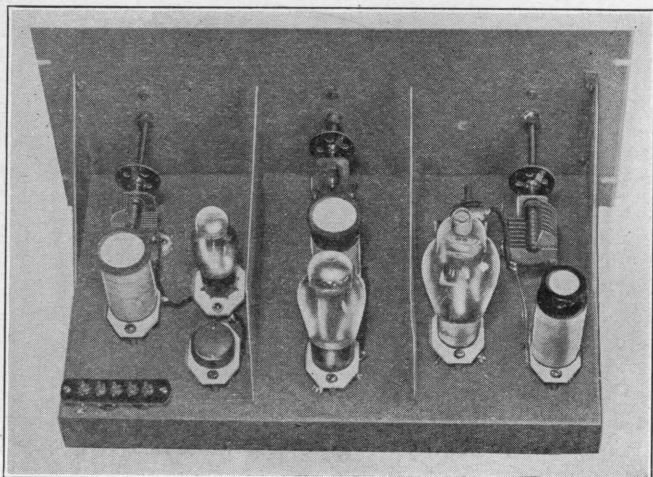
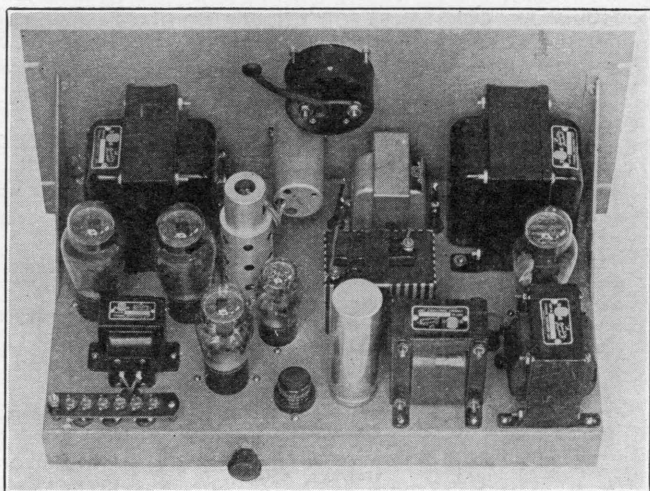

Figure 12. The exciter for the push-pull 809 phone consists of a 6J5G oscillator into a 6L6G buffer or doubler into an 809 buffer or doubler.

Figure 13. This deck contains the speech system, 6L6G modulators and 325-volt power supply. Note that the input jack and first audio tube are shielded, as is the input grid lead.



ate stray capacitive interstage coupling.

All variable condensers are mounted back from the front panels and are driven by means of extension shafts and flexible couplings.

Operation

If in doubt in regard to any of the initial tuning procedure (such as neutralizing the final amplifier), it is advisable to refer to the chapter on transmitter theory. The meter readings given in the adjacent column are typical of correct tuning and operation.

METER READINGS

6J5G cathode: 30 ma.
 6L6G cathode: 40 to 60 ma.
 809 buffer grid: 20 ma.
 809 buffer cathode: 50 to 120 ma., sufficient loading to give the final grids 50 ma.
 Final grids: 50 ma.
 Final cathode: 200 to 220 ma.

Figure 14. The 400-volt and 600-volt power supplies are contained in the bottom rack. The 600-volt supply uses 866-Jr. rectifiers and the 400-volt supply an 83 rectifier. All power supplies use choke input.

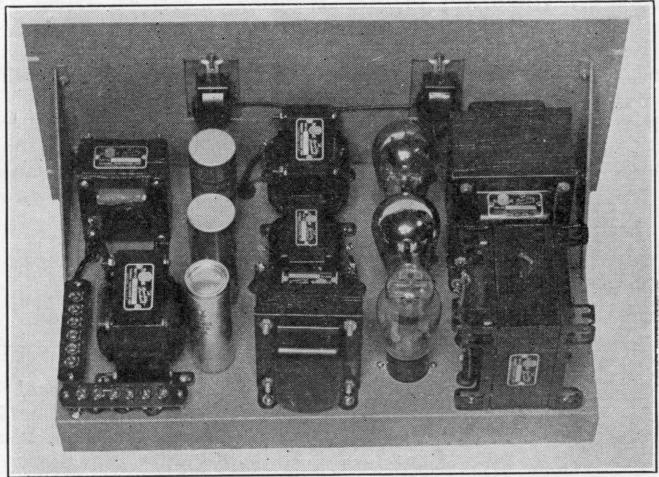

400-WATT 10-160 M. PLATE-MODULATED PHONE

While the amateur to whom price is no item will naturally want to run a full kilowatt input plate-modulated phone when interested in high power, the amateur who is interested in economy will do better to content himself with a transmitter running in the neighborhood of 600-watts input to the plate-modulated stage. Tubes and modulation transformers for this power are widely available and quite reasonably priced, but when one goes to a full kilowatt the price of these components goes up distressingly. As there is less than 3 db difference (just barely discernible) between a kilowatt and 600 watts input, the cost of the additional power will not be justified in the case of the majority of amateurs.

Hence, for a high-power phone transmitter, one delivering about 400 watts of carrier is shown—a very economical size. If one insists upon running a full kilowatt input, it is possible to do so with substantially the same circuit by replacing the 1250-volt power supply with a 1500-volt 400-ma. supply and the 1900-volt supply with a 2500-volt 400-ma. supply. This will permit the use of an HK254 or 100TH buffer and 250TH's or HK354D's in the modulated amplifier. Slightly greater spacing will be required for the plate tank condenser C_{18} .

The 203Z's can be replaced with 822's to deliver sufficient audio at 1500 volts to modulate fully a kilowatt input on speech waveforms.

400-WATT PHONE TRANSMITTER COIL DATA

BAND	6L6G PLATE	BUFFER & FINAL GRIDS	FINAL PLATE
160	66 turns #22 d.c.c. 1½" diam. closewound	80 turns #18 d.c.c. 2¾" diam. closewound center tap	Use 80-λ coil shunt- ed by fixed tank con- denser (see text)
80	30 turns #20 d.c.c. 1½" diam. 1½" long	36 turns #14 enam. 2¾" diam. 8 turns/in. center tap	28 turns #10 enam. 4½" diam. 4½ turns per in. center tap
40	15½ turns #18 d.c.c. 1½" diam. 1½" long	20 turns #14 enam. 2¾" diam. 5 turns/in. center tap	20 turns #10 enam. 3½" diam. 3 turns/in. center tap
20	7½ turns #16 enam. 1½" diam. 1¼" long	10 turns #14 enam. 2½" diam. 2½ turns per in. center tap	10 turns #10 enam. 3¼" diam. 1½ turns per in. center tap
10		6 turns #12 enam. 1¾" diam. 1½ turns per in. center tap	6 turns #10 enam. 2¼" diam. 1 turn/in. center tap

Construction of the 400-watt transmitter illustrated obviously is not for the newcomer. And the amateur who has had sufficient construction experience to warrant an attempt at the building of the transmitter will find the illustrations and wiring diagram largely self-explanatory.

The R. F. Exciter

A 6L6G harmonic oscillator, of the type previously discussed in connection with various other transmitters de-

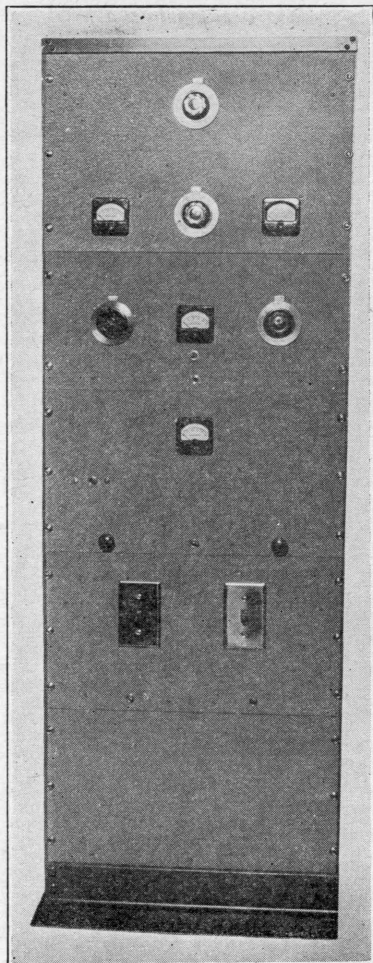

Figure 15. This five-foot relay rack contains a complete 400-watt (carrier) radiotelephone transmitter. A pair of class-B 203Z's plate-modulate a pair of push-pull 100TH's.

scribed, drives a 35-T or HK54 neutralized amplifier or doubler. This stage is link-coupled to the grid circuit of the modulated amplifier. The HK54 is first neutralized when working as a straight amplifier on 20 meters. The neutralization will then hold close enough and be sufficiently accurate for operation on all bands. The neutralizing condenser is not disturbed when the stage is used as a doubler.

The Modulated Amplifier

The tubes in the final amplifier "loaf" at between 550- and 600-watts input. While a pair of HK54's or 35-T's could be run at a half kilowatt input at the plate voltage specified, such input with plate modulation is rather severe and larger tubes will give longer life. HK254's or 100TH's can be run considerably under their rated maximum plate current rating and very long life can be expected.

Sufficient coupling between the buffer and modulated amplifier can usually be obtained with a single turn link around the center of buffer plate and final grid coils. If the grid current to the modulated amplifier runs over 80 ma., the grid tank condenser can be detuned slightly. If it is impossible to obtain 80-ma. grid current on the lower-frequency bands, two-turn links will be required for those coils.

To eliminate the need for a more bulky, higher capacity plate tank condenser for 160-meter operation, which would not be advisable for 10-meter operation due to the high minimum capacity, the following expedient is resorted to: the 75-meter amplifier plate coil is made slightly lower Q than optimum. The same coil is then used on 160 meters by shunting a fixed vacuum padding condenser of 50- $\mu\mu\text{fd}$. capacity across the tank tuning condenser. This results in a Q slightly higher than optimum for 160-meter operation, but the compromise design of the coil results in operation substantially as satisfactory as would be obtained with separate 75-meter and 160-meter coils.

The Speech System

The speech amplifier-driver and 300-watt modulator are conventional except for the incorporation of automatic peak

Figure 16. The plate-modulated 400-watt amplifier requires a tank condenser having wide spacing between plates.

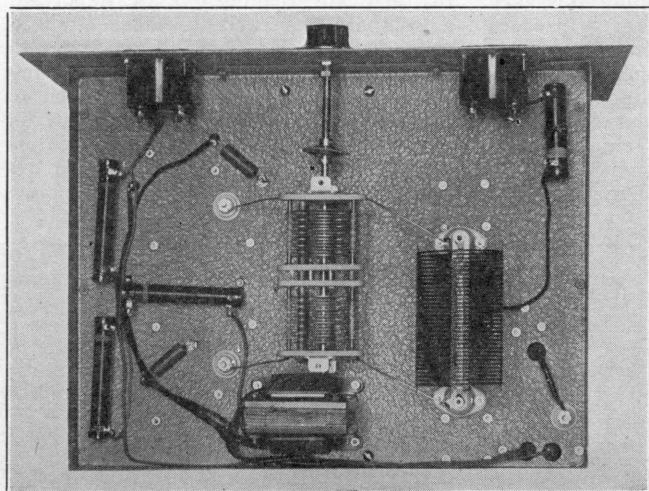
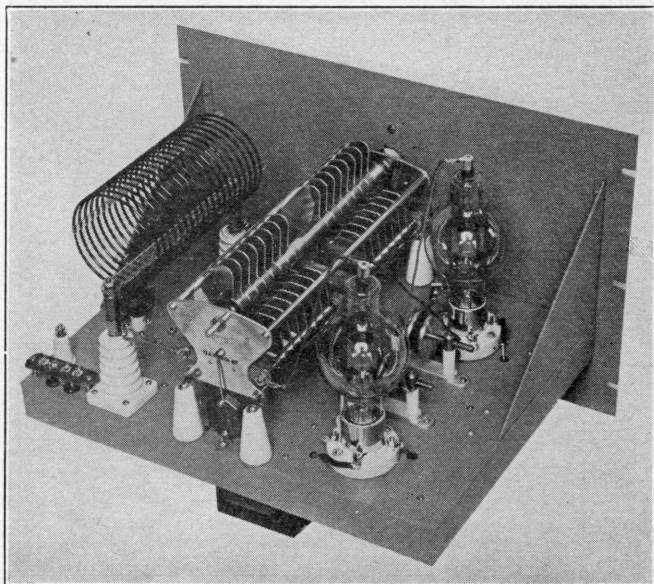

Figure 17. The modulated amplifier has its grid tank circuit and filament transformer mounted under the chassis.

compression to allow a higher average percentage of modulation without the danger of overmodulation on occasional loud voice peaks. The delay action (percentage modulation at which compression starts) can be adjusted by means of the potentiometer R_{21} . The modulators are fed from the same 1250-volt supply that furnishes plate voltage to the buffer amplifier.

All leads and components in the 6J7 first speech stage should be shielded to prevent grid hum and possible feed-

back. TZ40's can be substituted for the 203Z's by utilizing 9 volts of fixed battery bias. The tubes will supply sufficient output for complete modulation of 600 watts input when voice is used, though their life will not be as long as that of 203Z's.

The Power Supplies

The 350-volt and the 1250-volt power supplies are built on one chassis; the 1900-volt supply has a chassis all its

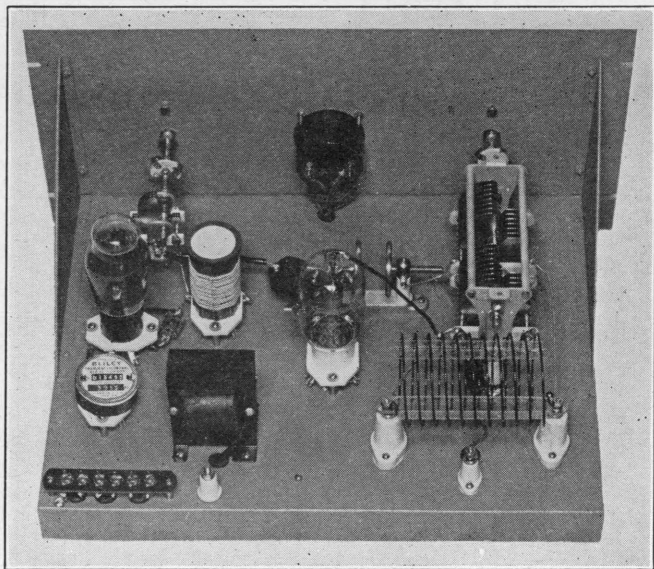

Figure 18. The r.f. exciter unit consists of a regenerative 6L6C harmonic oscillator driving an HK54 doubler or neutralized amplifier.

own. To keep the carrier hum at a very low level, a two-section filter is used in the 1900-volt supply feeding the modulated amplifier. As the push-pull modulators and the r.f. driver stage are relatively insensitive to a moderate amount of plate supply ripple, a single-section filter suffices for the 1250-volt supply.

While it is desirable to have six meters

to facilitate reading of all important grid and plate current values simultaneously, it is possible to get by with fewer meters by incorporating metering jacks. Such jacks should be placed in filament return leads rather than in plate leads when the plate potential is over 500 volts. Meters in filament return jacks read combined grid and plate

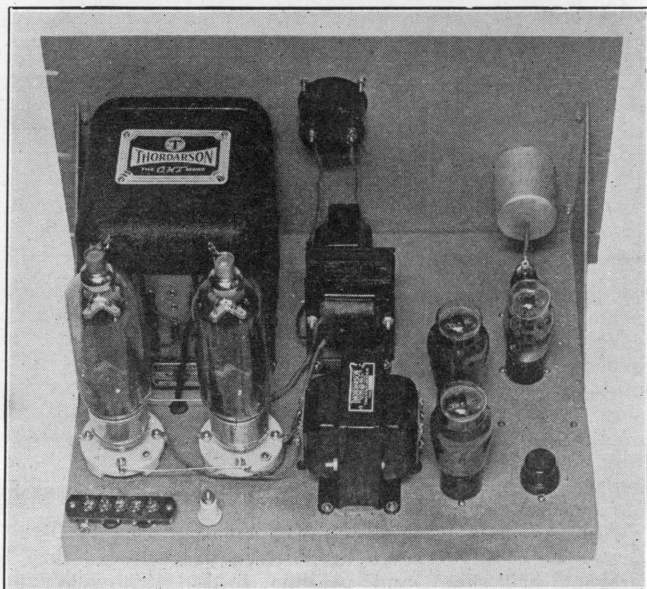
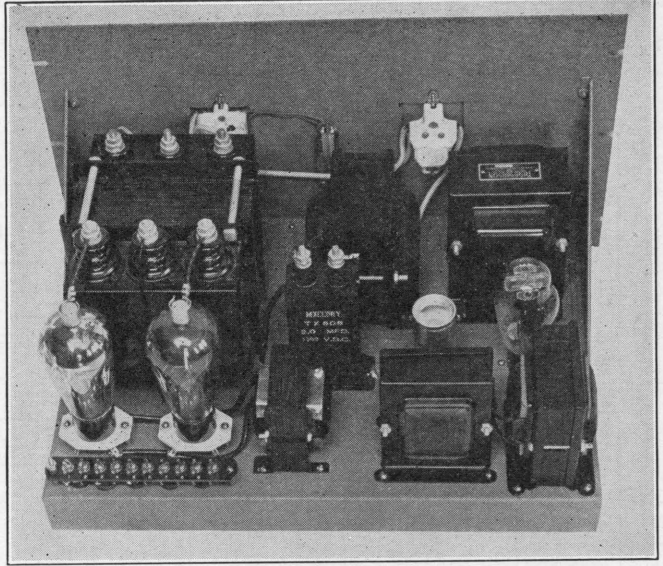

Figure 19. The speech amplifier and 300-watt modulator are contained in one rack unit. The shield on the back of the panel encloses the input jack, bias cell, grid resistor, etc.

Figure 20. This chassis contains a 350-volt power supply and a 1250-volt power supply. Low-voltage power supply components are to the right.



current, and the grid current should be subtracted from the meter reading to determine the actual value of plate current.

Construction

The mechanical construction and lay-

out of components can be observed in the various illustrations. All chassis measure 13"x17"x1½" and have end brackets to strengthen them. All panels are of standard 19" width, with heights as follows: Final amplifier 12¼", exciter 8¾", all others 10½". If all meters are placed on one panel at the top of the

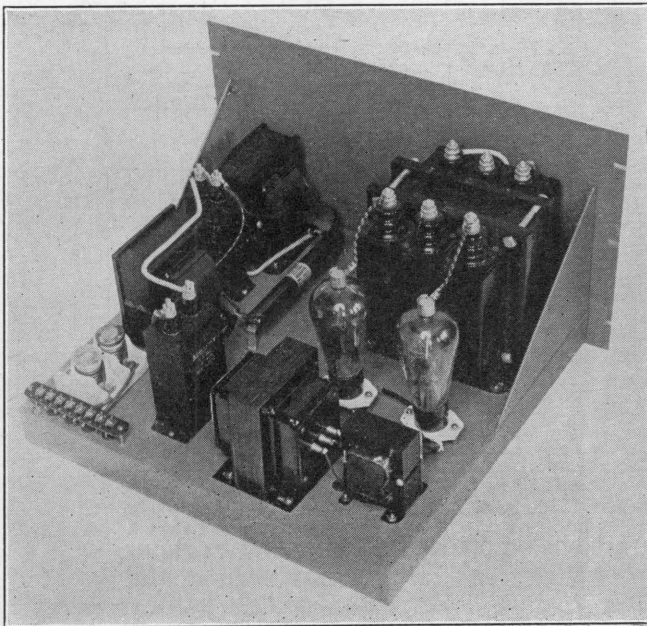

Figure 21. The 1900-volt heavy-duty power supply which feeds the modulated amplifier has a two-section filter to remove all trace of carrier hum.

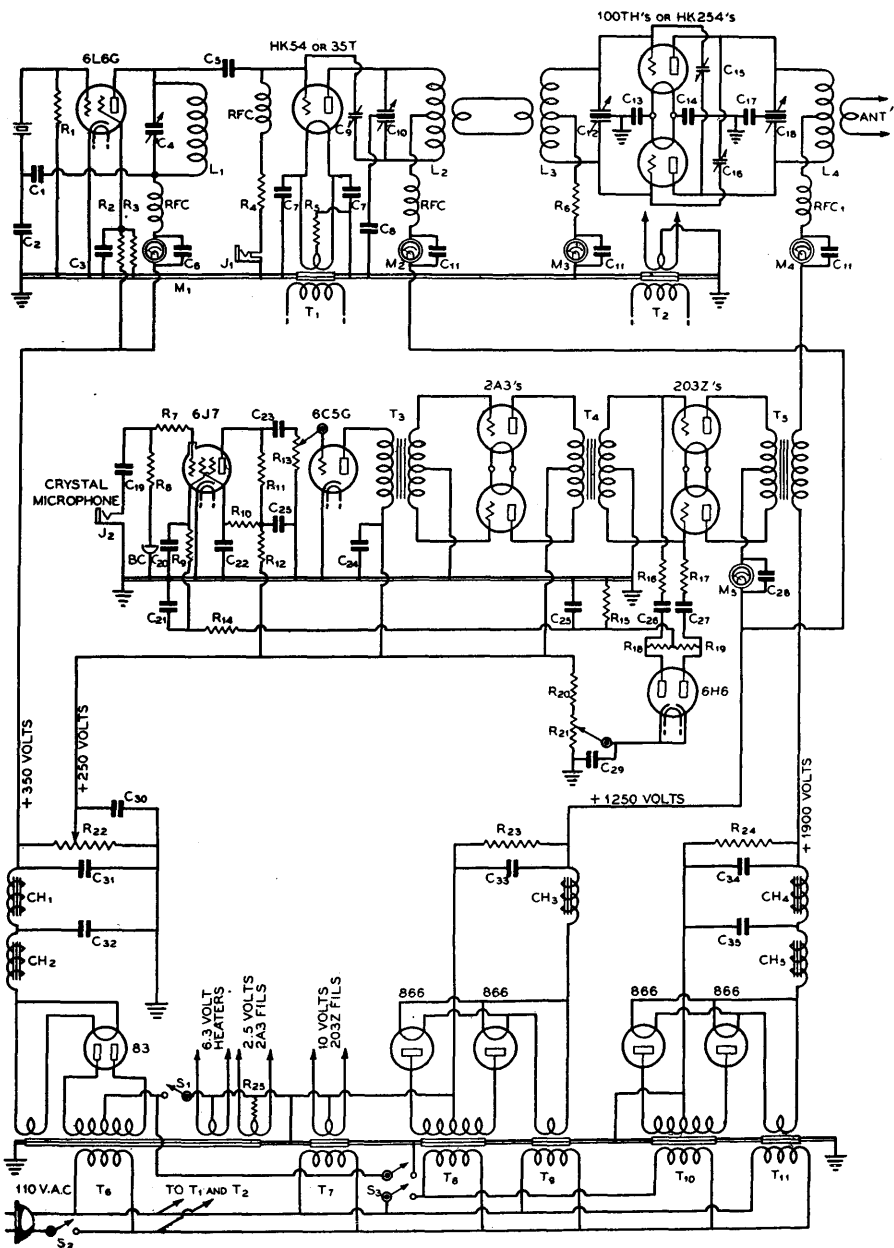

FIGURE 22. GENERAL WIRING DIAGRAM OF THE 400-WATT PHONE.

<p>C₁—.0004-μfd. mica C₂—.002-μfd. mica C₃—.01-μfd. tubular C₄—50-μfd. midget C₅—.0005-μfd. mica C₆—.002-μfd. mica C₇—.01-μfd. tubular C₈—.002-μfd. mica, 2500 volts C₉—Disc type neu- tralizing con- denser C₁₀—80-μfd. per section, 3000-v. spacing C₁₁—.002-μfd. mica C₁₂—80-μfd. per section, 3000-v. spacing C₁₃, C₁₄—.01-μfd. tubular C₁₅, C₁₆—Disc type neutralizing con- densers C₁₇—.002-μfd. mica, 5000 v. C₁₈—75 μfd. per section, 1/4" air gap C₁₉—.01-μfd. tubular C₂₀, C₂₁, C₂₂—0.1- μfd. tubular C₂₃—.01-μfd. tubular C₂₄—0.1-μfd. tubular C₂₅—0.5-μfd. tubular C₂₆, C₂₇—0.1-μfd. tubular C₂₈—.002-μfd. mica C₂₉—1-μfd. paper, 400 v. C₃₀, C₃₁, C₃₂—8-μfd. electrolytics, 450 volts C₃₃—2-μfd., 1500 v. v. C₃₄, C₃₅—2-μfd. 2000 v. v. R₁—100,000 ohms, 1 watt R₂—10,000 ohms, 10 watts R₃—50,000 ohms, 2 watts R₄—15,000 ohms, 10 watts R₅—300 ohms, 10 watts R₆—2000 ohms, 50 watts R₇—50,000 ohms, 1/2 watt R₈—1 meg., 1/2 watt R₉—250,000 ohms, 1/2 watt R₁₀—1 meg., 1/2 watt</p>	<p>R₁₁—250,000 ohms, 1 watt R₁₂—50,000 ohms, 1/2 watt R₁₃—1-meg. tapered pot. R₁₄—250,000 ohms, 1/2 watt R₁₅—100,000 ohms, 1 watt R₁₆, R₁₇—2 meg., 1/2 watt R₁₈, R₁₉, R₂₀—100,000 ohms, 1 watt R₂₁—50,000 ohms pot. R₂₂—25,000 ohms, 50 watts R₂₃—75,000 ohms, 100 watts R₂₄—100,000 ohms, 100 watts R₂₅—750 ohms, 10 watts RFC—2.5 mh., 125 ma. RFC₁—2.5 mh., 500 ma. M₁—0-100 ma. d.c. or meter jack M₂—0-200 ma. d.c. M₃—0-100 ma. d.c. or meter jack M₄—0-500 ma. d.c. M₅—0-500 ma. d.c. T₁—5 v. 6 amp. T₂—5 v. 15 amp. T₃—Push-pull input trans. T₄—Class-B input for 203Z T₅—300-watt variable ratio modu- lation trans- former T₆—440 v. each side c.t., 250 ma., and indicated fil. windings T₇—10 v. 7.5 amp. T₈—1500 v. each side c.t., 300 ma. T₉—2.5 v. 10 amp., h.v. insulation T₁₀—2200 v. each side c.t., 300 ma. T₁₁—2.5 v. 10 amp., h.v. insulation CH₁, CH₂—12 hy., 200 ma. CH₃—5-20 hy. 300 ma. CH₄—12 hy. 300 ma. CH₅—5-20 hy., 300 ma.</p>
---	--

rack as in figure 23, the .002- μ fd. by-pass condensers indicated in the wiring diagram are very necessary in order to protect the meters from radio-frequency current which may be picked up by the meter leads. The condensers should be placed directly at the meter terminals.

Operation

Initial tuning of as elaborate and ex-

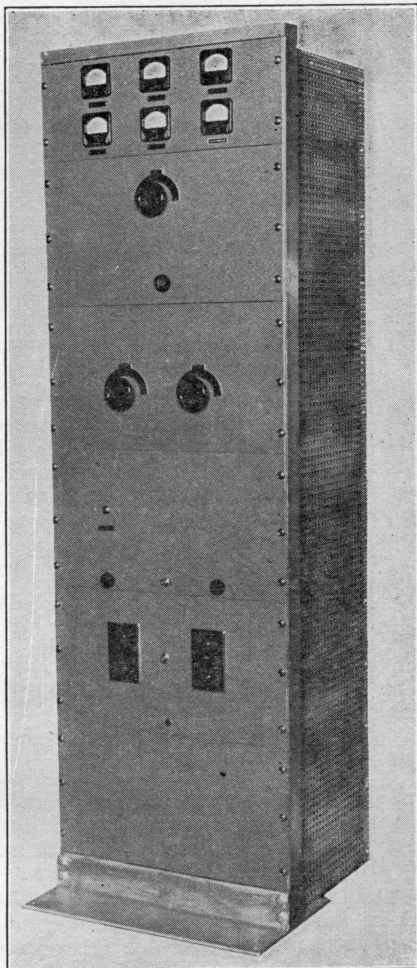

Figure 23. This model of the transmitter diagrammed in figure 22 uses HK254's in the final amplifier instead of 100TH's and contains meters for all circuits, eliminating the need for metering jacks. Except for mechanical considerations, the transmitter is the same as that of figure 15.

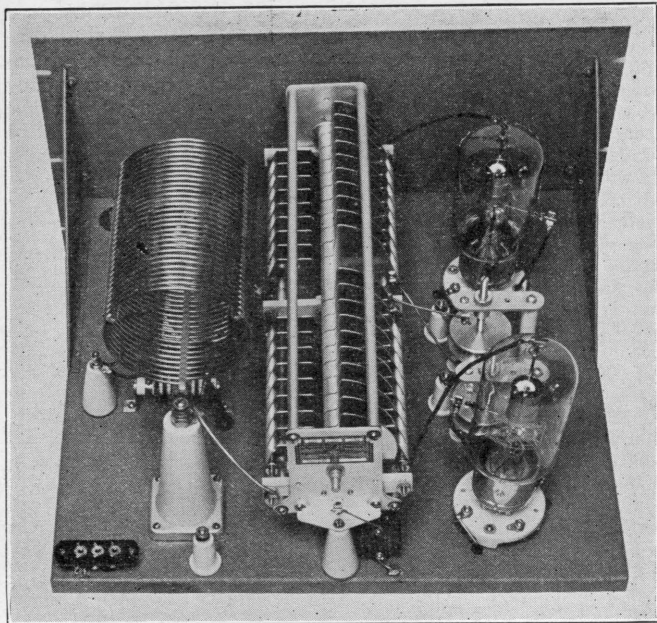

Figure 24. Final amplifier of the transmitter model illustrated in figure 23. The amplifier is similar to that of figure 16 except for tubes and make of components. The characteristics of HK254's and 100TH's are sufficiently alike that no changes in the circuit constants are required.

pensive a transmitter as this should preferably be done by an experienced amateur familiar with tuning and adjustment of high-power phone transmitters. General considerations regarding transmitter tuning and adjustments are covered in the transmitter theory chapter. The following meter readings are typical of normal operation:

6L6G cathode current: 35 to 60 ma.
 Buffer grid current: 10 to 15 ma.
 Buffer plate current: 50 to 75 ma. as buffer; 80 to 100 ma. as doubler.
 Final plate current: 300 to 325 ma.
 203Z plate current: 75 to 100 ma. static, swinging up to approximately 200 ma. on voice peaks.

1-KW. H.F. PHONE TRANSMITTER

The accompanying illustrations show a relay rack phone transmitter which is capable of operating with one kilowatt input to the final r.f. amplifier. The set was designed to fit entirely into one relay rack and to be used primarily on 10 and 20 meters. An adjustable type of audio automatic volume control system was incorporated in the set in order to prevent accidental overmodulation.

The carrier output runs about 800 watts at one kw. input. The power output can be varied from about 200 watts up to 1 kw. input by means of taps on the power transformer. Since this same power supply is connected to the class-B stage, the C-bias clip has to be changed

from $67\frac{1}{2}$ volts down to 45 and $22\frac{1}{2}$ volts for the different power transformer output voltages. Normally the set is operated at about 900 watts input in order to maintain a load of slightly less than full rating on the power supply, thus providing a safety factor.

The Harmonic Oscillator

The radio-frequency portion of the transmitter consists of a 6L6G harmonic oscillator, a 6L6G buffer-doubler, 35T buffer-doubler and push-pull 100-TH class-C amplifier. The 6L6G oscillator has a regenerative plate-cathode circuit in order to provide either fundamental

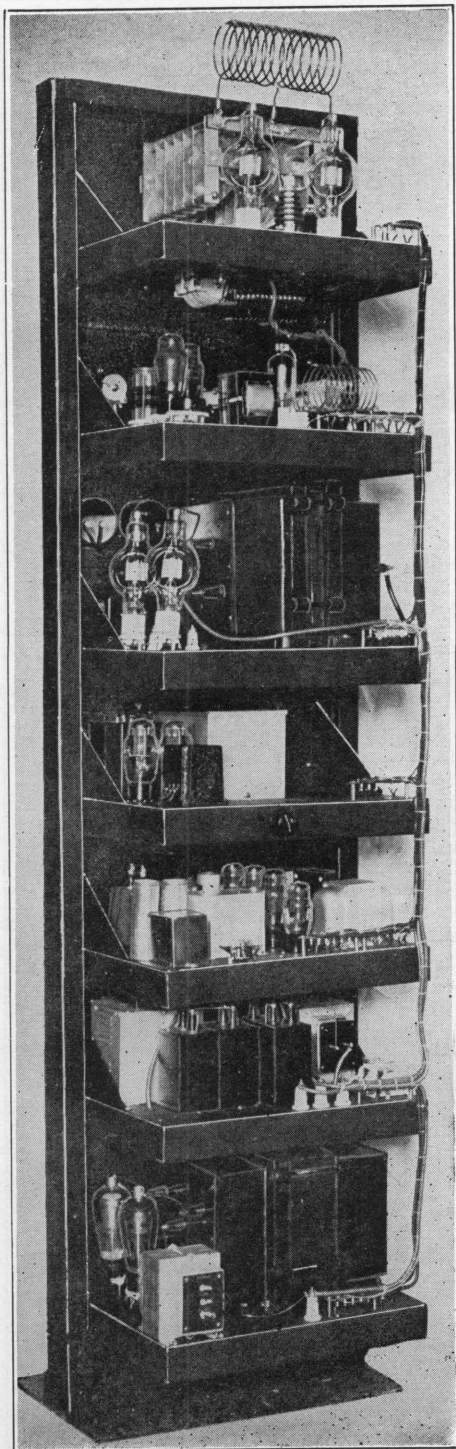

or second harmonic output from any crystal. One hundred and sixty- or 80-meter crystals can be used for operation in any band from 10 to 80 meters. The degree of regeneration is adjusted by means of a small 3-30- μ fd. mica trimmer condenser mounted between the plate and cathode terminals of the 6L6G socket.

The cathode bypass condenser of .0004 μ fd. is suitable for 160- and 80-meter crystals, but a smaller value, such as .00025 μ fd., is desirable with 40-meter crystals. This particular exciter does not require the use of 40-meter crystals for 10- or 20-meter operation.

The 6L6G First Buffer

The second 6L6G tube is neutralized to prevent self-oscillation when this tube is used as a buffer. Normally this tube is used as a doubler, in which case the plate neutralizing circuit is not needed but does no harm. A combination of grid leak and cathode bias is used with this tube in order to provide high bias for doubler operation and to protect the tube in case the crystal oscillator is not functioning. The two 6L6G cathodes connect to a d.p.d.t. toggle switch which connects either one through a milliammeter to ground. One meter measures the cathode current in either stage without disturbing the other.

The 35-T Buffer

The 6L6G doubler is capacitively coupled to a 35-T buffer or doubler stage. The 35-T is a neutralized buffer on 20 meters and is used as a doubler for 10-meter output.

The Modulated Final Amplifier

The 35-T stage is link-coupled to the 100-TH stage by means of a single turn of heavily insulated wire around the center of the two tank coils. The final amplifier uses a special "propeller-type" plate tank condenser which has the two neutralizing condensers built into the condenser frame. The two stators in this condenser are end to end directly across the rotor shaft and the two end plates serve as the plate neutralizing capaci-

Figure 25. The complete rack-mounted kilowatt phone transmitter.

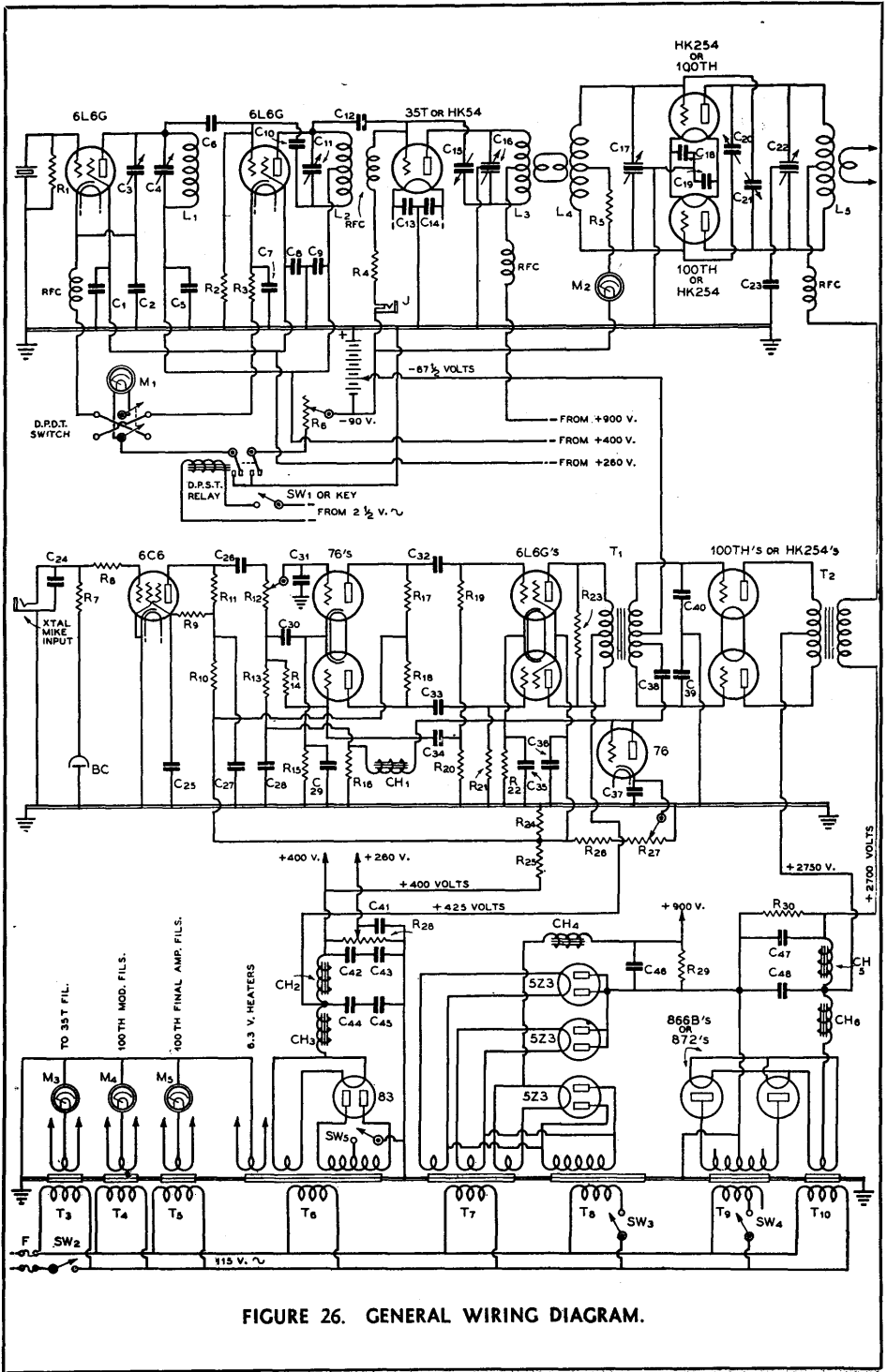

FIGURE 26. GENERAL WIRING DIAGRAM.

ties. Two circular plates mounted on screws through the Mycalex frame can be adjusted for neutralization. These two 2" diameter plates cross-connect to the two grids of the 100-TH tubes with the result that the neutralizing leads are very short.

The final tank coil mounts directly on the wing nut terminals of the tank con-

denser, which are close to the 100-TH plate cap leads. The net result is very effective operation even on 10 meters, and almost as high efficiency can be obtained at that frequency as on the lower frequency bands.

All grid bias voltages are taken from two medium-sized 45-volt B-battery blocks. Since the grid current is in the

FIGURE 26. CONSTANTS FOR THE WIRING DIAGRAM.

<p>C₁—.01-μfd. tubular C₂—.0004-μfd. mica C₃—3-30-μfd. mica trimmer C₄—50-μfd. midget C₅—.01-μfd. tubular C₆—50-μfd. mica C₇—.01-μfd. tubular C₈—.01-μfd. tubular or mica C₉—.01-μfd. tubular or mica C₁₀—3-30-μfd. trimmer with screw removed (see text) C₁₁—50-μfd. midget C₁₂—50-μfd. mica C₁₃—.01-μfd. tubular C₁₄—.01-μfd. tubular C₁₅—3-μfd. neutralizing condenser C₁₆—100-μfd. per section, 2000-volt spacing C₁₇—50-μfd. per section, 2000-volt spacing C₁₈—.01-μfd. mica C₁₉—.01-μfd. mica C₂₀, C₂₁—Neutralizing condensers (see text) C₂₂—50-μfd. per section, 16,000-volt spacing C₂₃—.002-μfd., 5000-volt mica C₂₄—.0001-μfd. mica C₂₅—.01-μfd. tubular, 400 volts C₂₆—.01-μfd. tubular, 400 volts C₂₇—.05-μfd. tubular, 400 volts C₂₈—.025-μfd. tubular, 400 volts C₂₉—.05-μfd. tubular, 200 volts C₃₀—.025-μfd. tubular, 400 volts</p>	<p>C₃₁—.00025-μfd. mica C₃₂, C₃₃—.01-μfd. tubular, 400 volts C₃₄—.02-μfd. tubular, 400 volts C₃₅—10-μfd. electrolytic, 50 volts C₃₆—8-μfd. electrolytic 450 volts C₃₇—.01-μfd. tubular, 400 volts C₃₈—.01-μfd. tubular, 400 volts C₃₉, C₄₀—.001-μfd. mica C₄₁ through C₄₅—8-μfd. electrolytics, 450 volts C₄₆—2 or 4 μfd., 1000 volts (working voltage) C₄₇—1 μfd., 4000 volts (working voltage) C₄₈—2 μfd., 4000 volts (working voltage) R₁—150,000 ohms, 1-watt carbon R₂—100,000 ohms, 1-watt carbon R₃—300 ohms, 10 watts R₄—1750 or 2000 ohms, 20 watts R₅—2000 ohms, 50 watts R₆—900 ohms adj., 20 watts R₇—.05 meg., 1-watt carbon R₈—25,000 ohms, 0.5-watt carbon R₉—2 meg., 1-watt carbon R₁₀—50,000 ohms, 1-watt carbon R₁₁—0.25 meg., 1-watt carbon</p>	<p>R₁₂—1-meg. tapered pot. a.f. vol. control R₁₃—0.25 meg., 1-watt carbon R₁₄—1 meg., 1-watt carbon R₁₅—2500 ohms, 1 watt R₁₆—0.25 meg., 1-watt carbon R₁₇, R₁₈—100,000 ohms, 1-watt carbon R₁₉—0.5 meg., 1-watt carbon R₂₀—35,000 ohms, 1-watt carbon R₂₁—0.5 meg., 1-watt carbon R₂₂—200 ohms, 10 watts R₂₃—20,000 ohms, 20 watts R₂₄—50,000 ohms, 2-watt carbon R₂₅—5000 ohms, 10 watts R₂₆—100,000 ohms, 2-watt carbon R₂₇—25,000-ohm pot. R₂₈—25,000 ohms, 50-watt adj. R₂₉—100,000 ohms, 50 watts R₃₀—100,000 ohms, 200 watts "multi-ratio") T₁—Tapped secondary class-B input transformer, with C₃₈ tapped down from one grid and ground (not particularly critical) T₂—500-watt (a.f.) variable tap class B output transformer, designed to carry class-C stage plate current</p>	<p>T₃—5.25 volts, 5 amp. T₄, T₅—5.25 volts, 14 amp. T₆—500 volts each side c.t., 75 watts. Also 5-v. and 6.3-v. filament windings T₇—Three 5-v. 3-amp. windings, insulated for 2000 volts T₈—500 volts each side c.t., 150 watts (c.t. not used) and 2.5-volt filament winding (used for relay) T₉—3000 volts each side c.t., 1500 watts (tapped primary) T₁₀—5 volts, 10,000-volt insulation, 10 amp. for 866-B or 20 amp. for 872 rectifiers CH₁—30-hy., 15 ma. or more CH₂—20-hy., 200-ma. smoothing choke CH₃—5-25-hy. 300-ma. swinging choke CH₄—5-25-hy. swinging choke, 200 ma. CH₅—20-hy. smoothing choke, 350 or 400 ma. CH₆—20-hy. smoothing choke, 500 or 550 ma. M₁—0-100 ma. d.c. M₂—0-100 ma. d.c. M₃—0-200 ma. d.c. M₄—0-300 ma. d.c. M₅—0-500 ma. d.c. BC—Bias cell (or pen flashlight cell)</p>
---	--	--	---

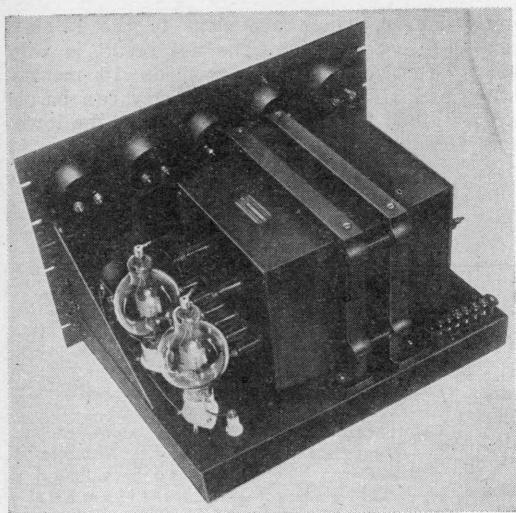

Figure 27. Here is the third deck down from the top of the transmitter. The class-B output transformer is necessarily a husky affair, taking up most of the space on the modulator chassis.

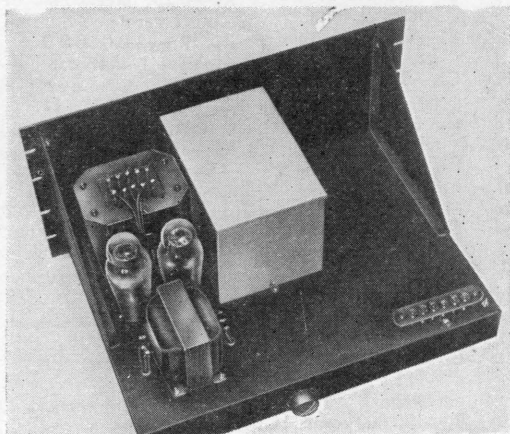

Figure 28. (Center) On the fourth deck from the top will be found the 6L6 drivers and the associated speech amplifier which is shielded.

Figure 29. The 400-volt and 900-volt power supplies are located on the fifth deck from the top.

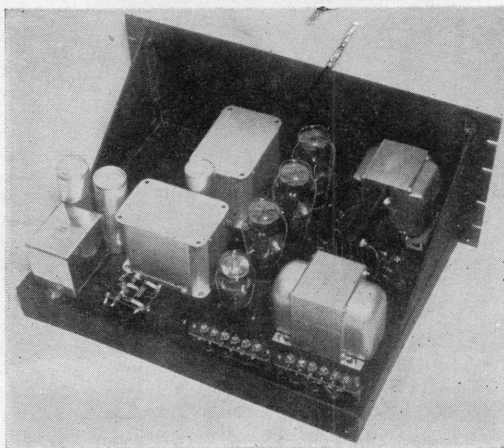
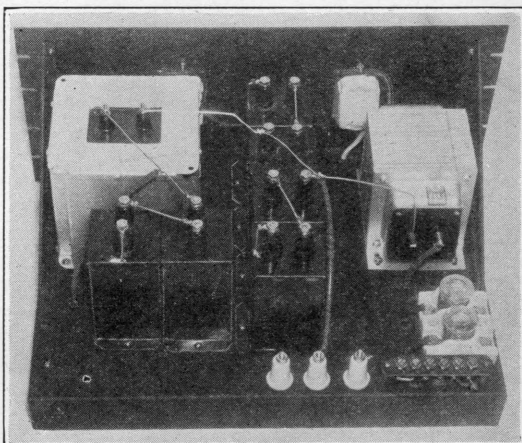

Figure 30. The high-voltage filter system takes up the entire sixth deck in the rack.



neighborhood of 100 ma., a 900-ohm resistor is connected across the 90-volt C battery in order to drain off this charging current. This resistor is connected across the battery only when r.f. excitation is applied, by means of extra contacts on the exciter cathode relay. This simple arrangement eliminates the need of a heavy-duty C bias supply and has much better voltage regulation for the class-B modulator grid circuit.

The Audio Channel

The audio channel consists of a 6C6 pentode high-gain audio amplifier for connection to a crystal microphone.

The class-B input transformer has one

side, or a tap part way up one side, connected back to a diode rectifier for a.v.c. The diode (a 76 triode with grid and plate tied together) has an adjustable bias in the cathode circuit in order to act as a delayed a.v.c. The amount of delay is adjusted to the point which will prevent overmodulation of the final amplifier.

This adjustment can be made with any overmodulation indicator or with an oscilloscope for detecting the presence of overmodulation.

The filter will follow the voice envelope and work satisfactorily on average speech. There is some audible distortion for high inputs with this and several

COIL TABLE FOR 1 KW. AMATEUR PHONE

Coil Tuning Band	6L6G Stages	35-T Plate	Final Grid	Final Plate
160	62 turns #22 d.s.c. 2" long 1½" diam.			
80	32 turns c.t. #22 d.s.c. 1½" long 1½" diam.	34 turns c.t. #14 4" long 2½" diam.	46 turns c.t. #14 4½" long 2½" diam.	24 turns c.t. #10 enam. 4" long 5" diam.
40	16 turns c.t. #16 enam. 1¼" long 1½" diam.			
20	8 turns c.t. #16 enam. ¾" long 1½" diam.	10 turns c.t. #10 3½" long 2½" diam.	14 turns c.t. #12 enam. 4" long 2½" diam.	12 turns c.t. ⅛" copper tubing 6" long 3" diam.
10		7 turns c.t. #10 4" long 2" diam.	8 turns c.t. #10 4" long 2" diam.	6 turns c.t. ⅛" diam. copper tubing 6" long 3" diam.



Figure 31. The heavy-duty high-voltage power transformer and the rectifiers are mounted on the bottom rack.

other a.v.c. systems tried, but it accomplishes the purpose of preventing accidental overmodulation and the voice quality is still understandable at very high input levels. At normal input level there is no distortion and the a.v.c. simply acts as a safety device.

The transmitter was built into a relay rack having $71\frac{3}{4}$ " of panel space. The chassis are all $17'' \times 13'' \times 2''$ of no. 18 and 16 gauge iron. The panels are standard sizes 19" long. The top final amplifier panel is $12\frac{1}{4}$ " wide as is the bottom high voltage power supply panel. All other panels are $8\frac{3}{4}$ " wide except the modulator, which has a $5\frac{1}{2}$ " wide meter panel and a 7" panel to complete the $12\frac{1}{4}$ "

space needed for the large modulation transformer.

The illustrations indicate the layout of parts for each chassis. Terminal strips were used for all medium- or low-voltage leads to each chassis.

The final tank condenser has a maximum capacity of $50 \mu\text{fd.}$ per section, which is a little low for 75-meter operation. Theoretically the plate current to the final amplifier should be reduced considerably for 75-meter band operation in order to maintain sufficient fly-wheel or Q in the tank circuit of this modulated stage. This should be done by decreasing the antenna load, not by lowering the plate voltage.

Amplifier and Modulator Units

PEAK COMPRESSING SPEECH AMPLIFIER

The speech amplifier to be described is one that is designed to feed the grids of a pair of high- μ class-B modulators such as TZ-40's, HK54's, 808's, ZB120's, 35-T's, etc., or to grid-modulate any transmitter requiring less than 10 watts of audio power. The input and output stages of the amplifier are conventional, the first designed to give sufficient gain to operate a crystal mike and the last

designed to give ample output power for the grids of the modulator stage. The balance of the amplifier is the unconventional part and comprises the phase inverter, the push-pull variable gain stage and the audio peak rectifier.

In this type of a volume compressing circuit, the compression tubes must operate in push-pull. The reason for this is obvious; since there is a control voltage being impressed upon these tubes,

and since it is varying at a syllabic rate, if we impress the voltage upon the grid of only one tube there will be a component in the plate circuit that is proportional to the *control* voltage variations. This will be amplified by succeeding stages and finally transmitted as a "hush-hush" noise every time an audio signal is impressed on the amplifier.

It has been found that the most effective way to cure the condition is to use a push-pull arrangement in the amplifier and to feed the control voltage *in parallel* to the two push-pull tubes. Thus the control-voltage variations will cancel out in the combined output of the plate circuits of the two tubes.

The particular phase inversion circuit used has a gain of one. In other words, there is no additional gain introduced by this stage. Ample gain is supplied by the combination of the single-ended 6J7 first stage and the push-pull 6J7 "variable-gain" stage.

Two push-pull 6J7's, pentode connected, are used in the variable-gain stage. The output of the phase inverter, the 6C5, is resistance-coupled to the input, and the plates are resistance-coupled into the succeeding amplifier. The stage itself is conventionally connected with the exception of the suppressor circuit. It is into the suppressor circuit that the control voltage is coupled.

With the amplifier operating below the point at which compression takes place, the suppressors are at ground potential but slightly negative with respect to the cathode. When a signal of sufficient amplitude to cause current to flow in the peak rectifier is encountered, a negative potential, proportional to the amplitude of this signal, is impressed on the suppressor grids of these two 6J7 tubes.

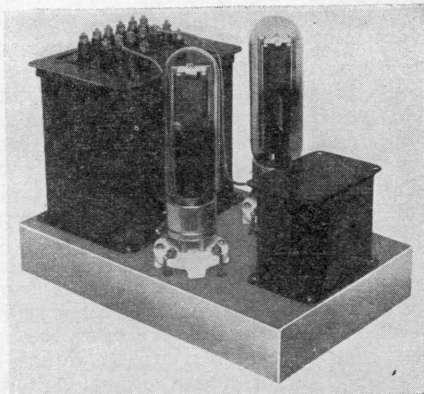

Typical 250-watt modulator utilizing ZB120 zero bias tubes in class-B and "Varimatch" output transformer. A 1250-volt power supply having good regulation and a 10- or 15-watt audio driver of low impedance are required. The latter may consist of 2A3's, or a pair of 6L6's with inverse feedback.

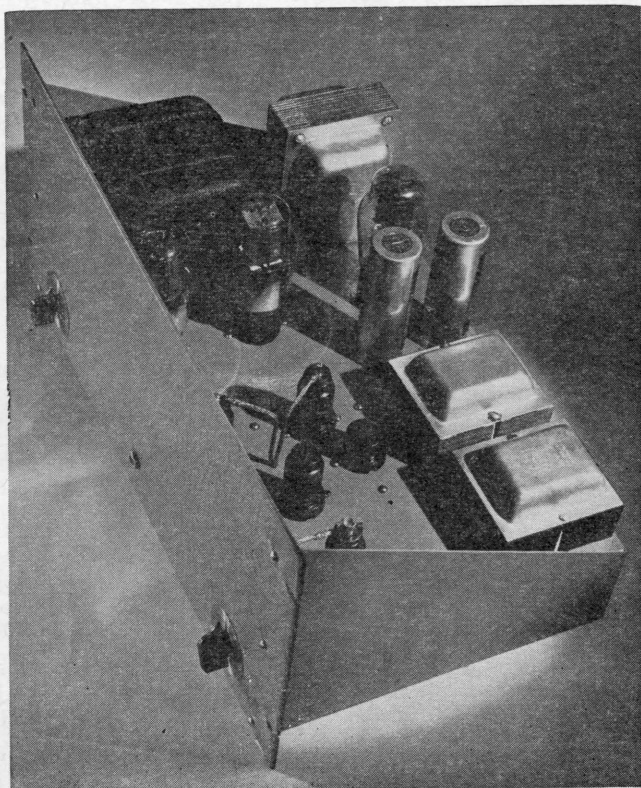

Figure 32. This peak compressing speech amplifier-driver or grid modulator allows the use of a higher average percentage of modulation, equivalent to an increase in carrier power.

This biasing potential on the suppressors reduces the transconductance of the stage. Since the gain-per-stage is directly proportional to the μ , the plate load resistance and the transconductance, and since the first two of these remain substantially constant as the suppressor voltage is varied, the gain will vary as does the transconductance.

If the 6H6 control rectifier were to begin to operate as soon as a signal came through the amplifier, continuous compression would be had and the peaks would go through, altered only to the extent that the balance of the signal is altered. This, of course, is not what we

desire. However, if a biasing voltage is placed upon the control tube, the point at which the rectifier begins to draw current and place bias upon the 6J7's can be manually adjusted. Potentiometer R_{24} serves this function.

By means of this potentiometer, a positive bias is placed upon the cathodes of the 6H6 control rectifier. Thus no rectification will take place until the instantaneous plate voltage exceeds the bias placed upon the rectifier cathodes.

By adjusting this bias to the point where current will not flow until the transmitter being fed by the amplifier is being modulated 70 to 80%, signals

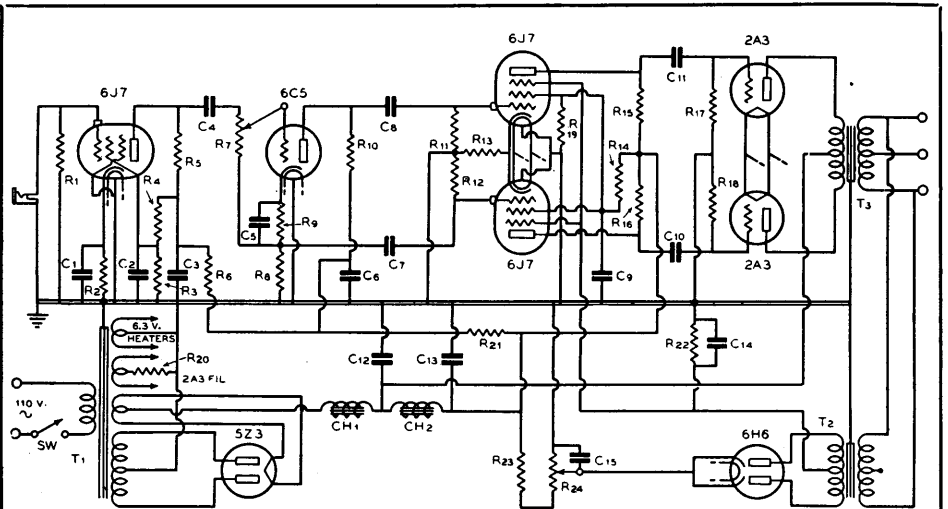

FIGURE 33. GENERAL WIRING DIAGRAM OF THE PEAK COMPRESSING AMPLIFIER.

- | | | | |
|---|---|--|---|
| C_1 —10- μ fd., 25-volt elect. | volt tubular | R_{10} —50,000 ohms, 1 watt | watt |
| C_2 —0.5- μ fd. 400-volt tubular | C_{15} —1.0- μ fd. 400-volt tubular | R_{11}, R_{12} —25 0, 000 ohms, 1 watt | R_{24} —15,000-ohm potentiometer |
| C_3 —8- μ fd. 450-volt elect. | R_1 —5 megohms, 1/2 watt | R_{13} —2,000 ohms, 1 watt | T_1 —Power transformer; 750 c.t., 5 volts 3 amps., 6.3 volts 3 amps., 2.5 volts 2 amps. |
| C_4 —0.1- μ fd. 400-volt tubular | R_2 —5,000 ohms, 1 watt | R_{14} —250,000 ohms, 1 watt | T_2 —1 1/2:1 ratio interstage transformer |
| C_5 —10- μ fd. 25 volt elect. | R_3 —50,000 ohms, 1 watt | R_{15}, R_{16} —250, 000 ohms, 1 watt | T_3 —Multiple-match driver transformer |
| C_6 —8- μ fd. 450-volt elect. | R_4 —250,000 ohms, 1 watt | R_{17}, R_{18} —250, 000 ohms, 1 watt | CH_1 —200 ma. swinging choke |
| C_7, C_8 —0.1- μ fd. 400-volt tubular | R_5 —250,000 ohms, 1 watt | R_{19} —50,000 ohms, 1 watt | CH_2 —20-hy., 100-200-ma. filter choke |
| C_9 —0.5- μ fd. 400-volt tubular | R_6 —10,000 ohms, 1 watt | R_{20} —750 ohms, 10 watt | SW—Optional a. c. line switch |
| C_{10}, C_{11} —0.1- μ fd. 400-volt tubular | R_7 —500,000-ohm potentiometer | R_{21} —20,000 ohms, 1 watt | |
| C_{12}, C_{13} —8- μ fd. 450-volt elect. | R_8 —50,000 ohms, 1 watt | R_{22} —250,000 ohms, 1 watt | |
| C_{14} —0.1- μ fd. 400- | R_9 —5,000 ohms, 1 watt | R_{23} —50,000 ohms, 1 watt | |

of greater amplitude will cause current to flow, with a consequent reduction in the gain of the amplifier.

Peaks which ordinarily would considerably overmodulate the transmitter will be compressed by the action of the speech amplifier. Also, due to this peak compressing action, all normal speech of amplitude great enough to modulate the transmitter more than 75% will be compressed in proportion to its amplitude. Thus, the gain control on the speech amplifier may be operated at a higher position (with a consequent increase in average side-band power) with this type of a speech amplifier than with one of the conventional type.

Push-Pull Power Amplifier

The power amplifier stage, using a

pair of 2A3's, is entirely conventional except that resistance coupling is used into the grid circuit. The plate circuits of the two tubes work into one of the new multiple-tap driver transformers. The taps on the secondary of the transformer may be varied to suit the particular tubes that are to be used in the succeeding stage.

The power supply also is conventional. A single 83 tube is used as rectifier and the various stages are filtered in accordance with the level at which they operate.

The amplifier has an undistorted output of about 8 watts at the plate voltage employed, more than ample to drive the previously mentioned tubes as class-B modulators or to modulate a grid-modulated amplifier running less than about 300 watts input.

SPEECH AMPLIFIER WITH A.M.C.

Figure 36 shows the circuit of a complete speech amplifier and driver incorporating such features as a.m.c., a two-channel audio mixer having four separate inputs, a voltage sensitivity of better than 0.002 peak volt, a push-pull output stage delivering about 10 watts of high-quality audio power and a self-contained power supply minus any hum difficulties. Figures 34 and 35 show two views of the amplifier. The circuit wiring is made with more attention to short leads than to appearance.

The two 6J7 mixer tubes have a common plate-load resistor, the resistance of which can readily be changed to increase or decrease the maximum gain of the amplifier. Values between 10,000 and 100,000 ohms can be used, the lower value providing just enough gain for close talking into a crystal microphone. The higher value increases the gain so that the operator can talk at a considerable distance from the microphone.

Four separate input jacks are provided—two for each mixer tube. J_1 and J_2 are high-impedance inputs for a crystal microphone or other high-impedance signal source. J_3 is for a 500-ohm line and J_4 is primarily intended for a double-button carbon microphone. Voltage for the latter is supplied by potentiometer

R_{28} , which should be set at its grounded end before the microphone is plugged in. J_4 can also be used for a low-impedance line, provided the movable arm of R_{28} is grounded. Either input of one 6J7 can be mixed with either input of the other 6J7, switches S_1 and S_2 being provided to select the inputs desired.

Manual volume control of the mixed output of the 6L7 is made by means of potentiometer R_{20} , at the input of the 6N7 phase inverter. Some of the circuit constants shown are somewhat critical. The values given in figure 36 are recommended as being the result of a considerable amount of testing in actual station operation.

The aluminum chassis employed measures 17"x12"x3 $\frac{3}{4}$ ". It is physically somewhat larger than necessary, but it is desirable to place the input transformer T_1 as far away as possible from the power transformer to lessen the possibility of hum pickup. The size of the input filter condenser C_{10} and the d.c. resistance of filter chokes L_1 and L_2 are important as regards obtaining the proper d.c. output voltages. Because the push-pull 2A3's are self-biased, there is not much shift in the d.c. load current between no-signal and full-signal conditions. For this reason, a filter of the

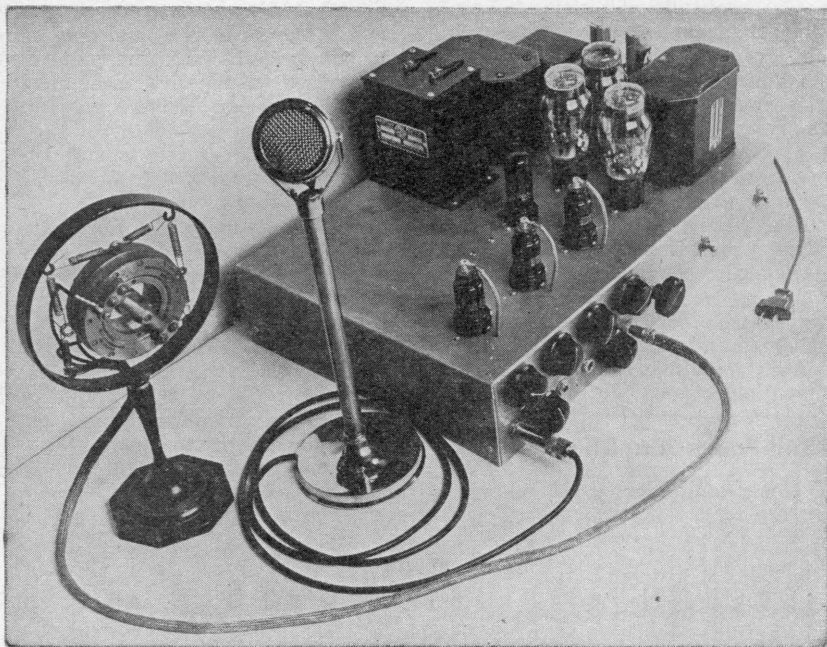

Figure 34. The complete a.m.c. amplifier shown with a crystal and a double button microphone attached to two of the amplifier's four input circuits. Electronic mixing is used to mix any of the four inputs. The peak rectifier unit is external (at the transmitter) and is not shown.

condenser-input type provides sufficiently good voltage regulation.

There is little need for the a.m.c. off-on switch (S_2) in actual station operation. It is useful, however, when the amplifier is being tested initially for the operation of the a.m.c. circuit. For this testing, a cathode-ray oscilloscope is useful. A pattern of either the trapezoidal or the modulated-envelope type is suitable for test purposes. If the latter type of pattern is used, the linear sweep-circuit oscillator should be synchronized with the speech amplifier.

The output transformer T_5 is designed with several secondary taps to match various voice-coil impedances as well as a 500-ohm line. The latter is used to connect the 2A3's to the class-B modulator tubes, through a line-to-push-pull-grid input transformer. Thus, the amplifier can readily be adapted to p.a. work provided a separate source of field excitation is available for the speaker field coils. The 2A3's can be coupled directly to the grids of the class-B modulator provided a suitable transformer is used at T_5 .

The audio rectifier tube (type 879) and its filament transformer should be mounted *in the modulator unit* and not on the speech-amplifier chassis, in order to keep all high-voltage leads away from the speech equipment. The lead from the 879 plate to the a.m.c. bias terminal on the speech amplifier is not at a dangerous potential. *This will be dangerous, however, if the 879 is connected incorrectly!* The secondary of the 879 filament transformer (T_3) should be insulated for twice the d.c. plate-supply voltage of the modulated r.f. amplifier, plus 1000 volts. For a final r.f. stage operating at 1250 volts, T_3 should be insulated for at least 3500 volts. The 879 can be used where the d.c. plate voltage of the modulated r.f. amplifier does not exceed about 3000 volts. Higher d.c. voltages will exceed the peak inverse voltage rating of this tube.

Performance

The advantages of the particular a.m.c. system used in this amplifier may be summarized as follows:

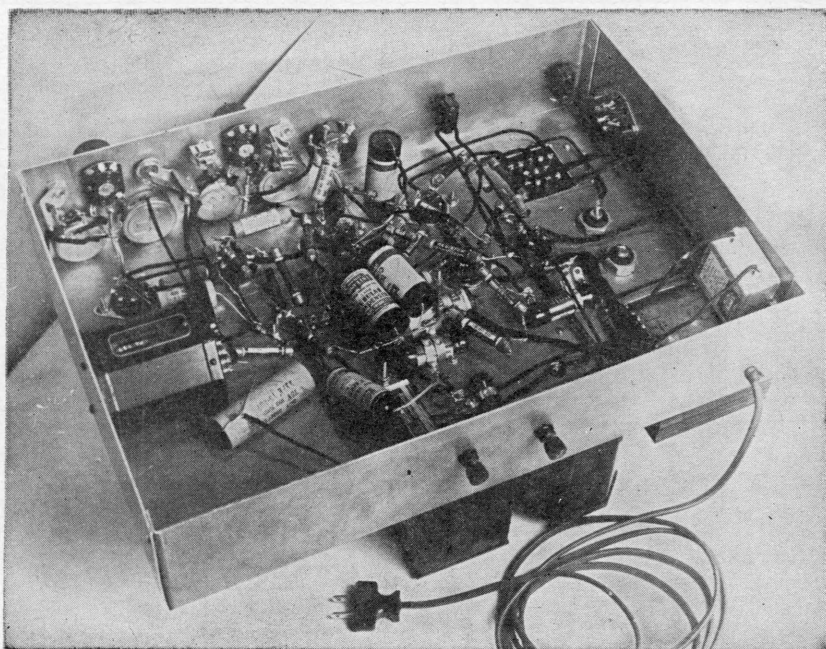

FIGURE 35. BOTTOM VIEW OF THE AMPLIFIER OF FIGURE 34.

1. Substantially eliminates all overmodulation.
2. Increases the *average* sideband power several db, thus providing an actual gain in the effective audio signal at the receiver.
3. Makes the modulated carrier clean and sharp, due to the elimination of side-splatter caused from carrier cutoff on excessive negative modulation peaks.
4. Operates entirely on the *negative* audio peaks, which are the ones that ordinarily cause the most trouble.
5. Can be adjusted to limit the percentage of modulation to any predetermined value, by means of the "advance" bias on the audio rectifier.
6. Reduces the chance of overloading the modulator, in a properly designed transmitter.
7. Eliminates the necessity of adjusting a manual gain control when the operator changes his voice level or his position slightly with respect to the microphone.
8. Eliminates the practical need (although perhaps not the legal necessity) for a modulation indicator, as well as the nuisance of continually watching such a device.
9. Greatly reduces broadcast interference, because of no. 3.
10. Is inexpensive, inasmuch as few extra parts are required other than those in an ordinary speech amplifier.
11. Causes substantially no audio waveform distortion.
12. Causes no "hush-hush" effects.
13. Obtains the negative control voltage directly from the *modulator*, rather than from the driver stage, so that the controlling action depends on the actual relation between the d.c.

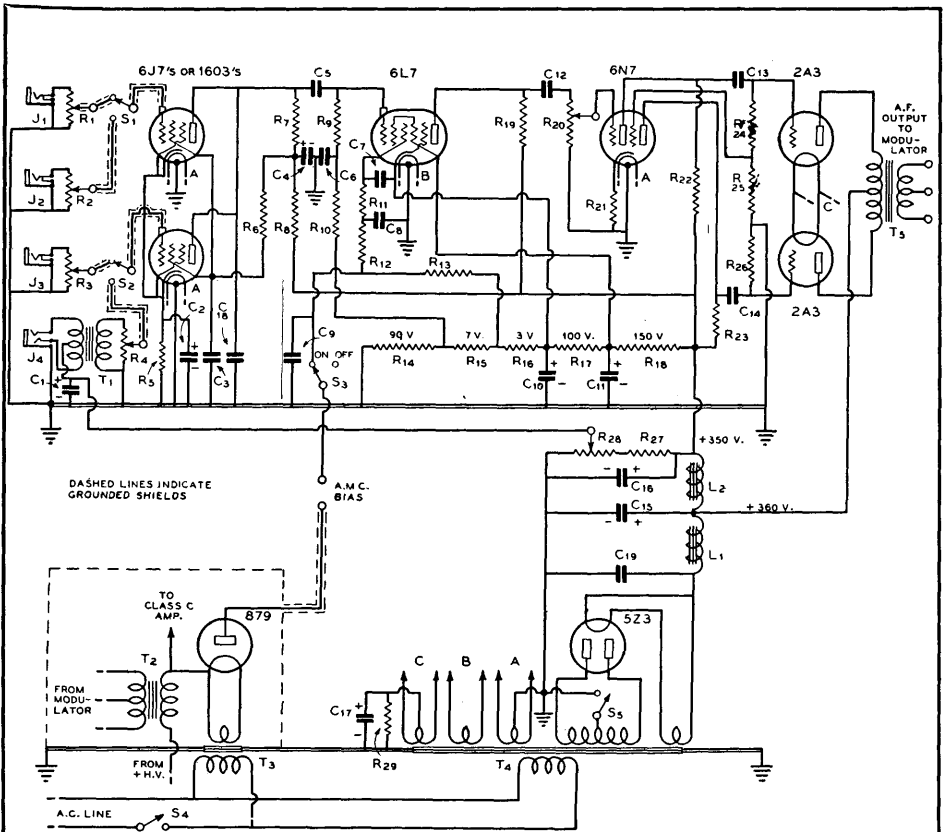

FIGURE 36. GENERAL WIRING DIAGRAM OF THE A.M.C. SPEECH AMPLIFIER-DRIVER.

- | | | | |
|--|--|--|--|
| C ₁ —25- μ f. 50 - volt elect. | C ₁₆ —8- μ f. 450-volt electrolytic | R ₁₀ —500,000 ohms, 1/2 watt | R ₂₂ , R ₂₃ —100,000 ohms, 1 watt |
| C ₂ —25- μ f. 25 - volt elect. | C ₁₇ —50- μ f. 100 - volt electrolytic | R ₁₁ —1.0 megohm, 1 watt | R ₂₄ —250,000 ohms, 1/2 watt |
| C ₃ —0.1- μ f. 400 - volt tubular | C ₁₈ —.0002- μ f. mica | R ₁₂ —100,000 ohms, 1/2 watt | R ₂₅ —12,000 ohms, 1/2 watt |
| C ₄ —8- μ f. 450-volt elec. | C ₁₉ —1.0- μ f. 750 - volt tubular | R ₁₃ —500,000 ohms, 1 watt | R ₂₆ —250,000 ohms, 1/2 watt, |
| C ₅ —.02- μ f. 400 - volt tubular | R ₁ —1 - megohm potentiometer | R ₁₄ —4500 ohms, 5 watts | R ₂₇ —15,000 ohms, 20 watts |
| C ₆ , C ₇ —0.5 - μ f. 200-volt tubular | R ₂ —500-ohm potentiometer | R ₁₅ —350 ohms, 1/2 watt | R ₂₈ —1500-ohm potentiometer |
| C ₈ , C ₉ —.002 - μ f. d. mica | R ₃ —1-megohm potentiometer | R ₁₆ —150 ohms, 1/2 watt | R ₂₉ —780 ohms, 25 watts |
| C ₁₀ , C ₁₁ —8- μ f. 250-450-volt electrolytic | R ₄ —500-ohm potentiometer | R ₁₇ —5000 ohms, 5 watts | S ₁ , S ₂ —S.p.d.t. switches |
| C ₁₂ —.02- μ f. 400 - volt tubular | R ₅ —500 ohms, 1/2 watt | R ₁₈ —7500 ohms, 5 watts | S ₃ , S ₄ , S ₅ —S.p.s.t. switches |
| C ₁₃ , C ₁₄ —.015- μ f. 400-volt tubular | R ₆ —250,000 ohms, 1/2 watt | R ₁₉ —100,000 ohms, 1/2 watt | J ₁ , J ₂ , J ₃ —Shielded, closed-circuit jacks |
| C ₁₅ —16- μ f. 500 - volt electrolytic | R ₇ , R ₈ —50,000 ohms, 1/2 watt | R ₂₀ —100,000 - ohm potentiometer | |
| | R ₉ —100,000 ohms, 1/2 watt | R ₂₁ —1500 ohms, 1/2 watt | (See next page) |

(Continued from page 404)

<p>J₁—Shielded, 3-circuit jack for double - button microphone</p> <p>T₁—Microphone-to - 500-ohm line transformer</p>	<p>T₂—Modulation transformer</p> <p>T₃—2.5-volt filament transformer, insulated for 5000 volts</p>	<p>T₄—Power trans - former</p> <p>T₅—Output trans - former; 5000-ohm plate-to-plate impedance</p> <p>L₁—12-henry, 120-</p>	<p>ma. filter choke; d.c. resistance, 80 ohms</p> <p>L₂—40-henry, 50-ma. filter choke; d.c. resistance, 250 ohms</p>
--	--	---	---

plate and the peak modulating voltage applied to the modulated r.f. amplifier—a basic advantage not obtained with ordinary audio a.v.c. or peak-limiting circuits where the control-

ling voltage is taken from the driver stage.

14. Is in no way tricky to adjust or to operate, provided the 6L7 is supplied with the proper voltages from the bleeder circuit.

MODERN SPEECH AMPLIFIER-MODULATOR

Illustrated in figures 37 and 38 and diagrammed in figure 39 is a complete speech channel capable of plate-modulating an input of between 500 and 600 watts on voice. It incorporates a.m.c., inverse feedback and other desirable modern features.

The combined speech amplifier-class-B modulator, with the associated power supply for the speech amplifier, is built upon one 24"x10"x3" metal chassis. The under side of the chassis is not painted; the plated cadmium finish on this side facilitates the grounding of the various components.

The power supply for the speech stages is mounted along the left hand side of the chassis. Then there are mounted, in a row, the 6J7 first audio stage, the 6L7 a.m.c. amplifier and the 6F6 last audio. Then, in the next row, in front is the multitap driver transformer for the class-B stage, then the two 6V6 drivers and, in back, the coupling transformer between the 6F6 and the two 6V6G's. On the right hand end of the chassis are mounted the two TZ40 modulators and their associated class-B output transformer.

Looking at the front of the chassis can be seen at the extreme right, the on-off switch for all filaments and for the plate supply for the speech amplifier. The plate supply for the TZ40's is controlled at the transmitter proper. The

next switch is the on-off switch for the a.m.c. circuit. Then comes the gain control, the microphone input jack and the binding post for connection to the a.m.c. peak rectifier.

The under-chassis view is practically self-explanatory. At the extreme right end of the chassis is the 7.5-volt filament transformer for the TZ40's and to the left of the center of the chassis are mounted the resistor plates. Only the upper one can be seen as the two are mounted one above the other.

Electrical Design

The speech amplifier uses a 6J7 metal tube connected as a high-gain pentode in the input. The circuit is conventional and the tube is designed to operate from a diaphragm-type crystal microphone. The closed circuit jack on the input of the amplifier is shielded by a small metal can to eliminate any possibility of coupling between the output of the amplifier and the input circuit. Since the large metal spring of the jack is at grid potential, it is desirable to shield it from the output circuit of the 6V6G's and from the a.m.c. lead which runs very close to the jack.

The 6L7 A.M.C. Stage

The second stage of the amplifier—the a.m.c. stage—utilizes a 6L7 tube and

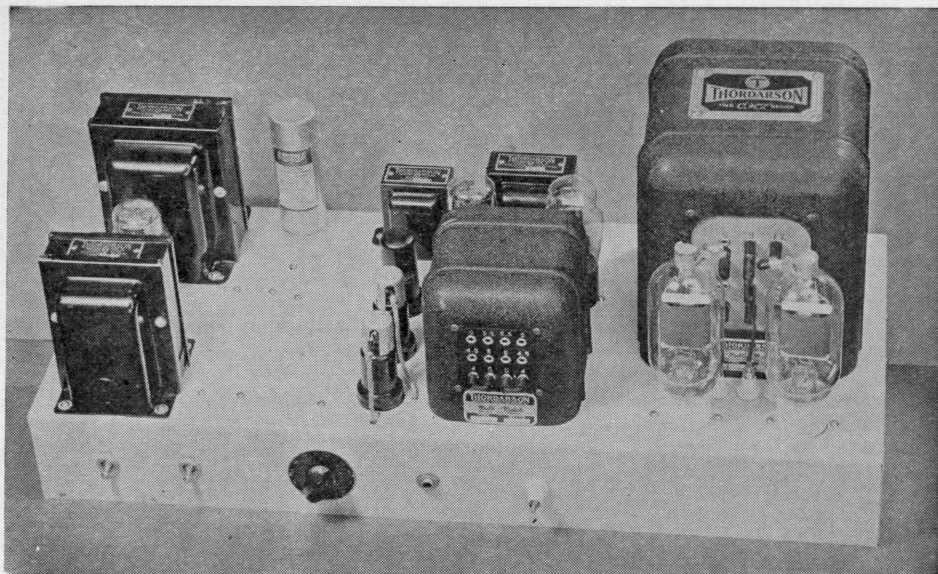

Figure 37. This combined speech amplifier and class-B modulator will plate modulate a half-kilowatt input on voice. It incorporates inverse feedback, a.m.c., and other modern features.

is connected essentially the same as the analogous stage in the amplifier previously described. The 500,000-ohm volume control is placed between the plate circuit of the 6J7 and the control grid of the 6L7. It is important that this potentiometer be of the insulated-shaft type since the entire 6L7 circuit operates considerably above ground potential.

The 879 reverse peak rectifier should be connected as follows: the plate of the tube should be connected directly to the a.m.c. binding post on the amplifier, and the filament of the tube should be connected to the lead that goes to the plates of the modulated class-C amplifier. The filament should be lighted from a 2.5-volt filament transformer that is adequately insulated for twice the average plate voltage of the modulated amplifier plus 1000 volts. Also, it is often a good idea to remove the negative peak rectifier as far as conveniently possible from both the speech amplifier and the class-C final.

Since the injection grid of the 6L7 a.m.c. amplifier is 70 to 90 volts above ground potential (the whole a.m.c. stage is, as mentioned before, at this potential above ground), the 879 peak recti-

fier will begin to operate when the plate voltage on the class-C amplifier becomes less than 70 or 90 volts, whatever the case may be. Then, as the modulator tends to drive the plate voltage lower than this, the gain on the speech amplifier will be reduced as the injector-grid bias on the 6L7 becomes negative. As this negative bias is increased, the signal output of the modulator is reduced. The final result: the output voltage of the modulator is reduced to an amount that will not cut the negative-peak plate voltage on the class-C stage to zero; consequently, there is no overmodulation.

The gain on the speech amplifier may be run up to an amount which will permit a higher average voice level from the transmitter without any chance of overmodulation under any case. When the resulting signal is heard over the air, the transmitter seems to be modulated at a much higher percentage although there is no tendency toward overmodulation splatter or hash.

The 6V6G Drivers

A pair of 6V6's or 6V6G's are connected as tetrodes with degenerative feedback coupled into their screen cir-

cuits. This method of connection for the 6V6G's adapts them very well as drivers for the TZ40's since the plate impedance of the tubes is very considerably lowered by this method of connection.

Beam tetrodes when connected in the conventional manner are not particularly well-suited as drivers for a class-B stage unless a considerable amount of swamping is used. The high plate resistance of the tubes in the conventional method of connection causes a large drop in output voltage when any increase in load is placed upon them.

When first placing the amplifier in operation, it is very important that the screens be connected to the proper side of the class-B modulation transformer secondary. The only way of finding out which side is the proper one is to connect up the amplifier and try it out. It is best not to have the plate voltage on the TZ40's when this test is made—something may flash over. If the 6V6G's do oscillate, reverse the connections between the screen grid coupling condensers and the class-B grids, and the correct phase relation between the screen and plate voltages will be obtained.

The TZ40's operate with zero bias under the conditions recommended by the manufacturers. The standing plate current on the two tubes is approximately 45 ma. with an applied plate voltage of 1000 volts. It will be somewhat higher, in the vicinity of 60 ma., if the full rated plate voltage of 1250 volts is used. Since this value of standing plate current results in an appreciable amount of plate dissipation, a small amount of grid bias is desirable in order to lower the plate current under no-signal

conditions. A pair of 4½-volt batteries in series to give 9 volts are suitable for bias for 1250-volt operation.

For maximum peak power output from the TZ40's (for the adjustment which will modulate the greatest class-C input with voice) the plate-to-plate load impedance for the 1000-volt conditions would be 5100 ohms. Under these conditions of operation, the modulator would be capable of 100% voice-modulating an input of 500 watts to the class-C stage; the plate current on the TZ40's should kick up to 200 to 250 ma. under normal modulation.

For maximum peak modulating capa-

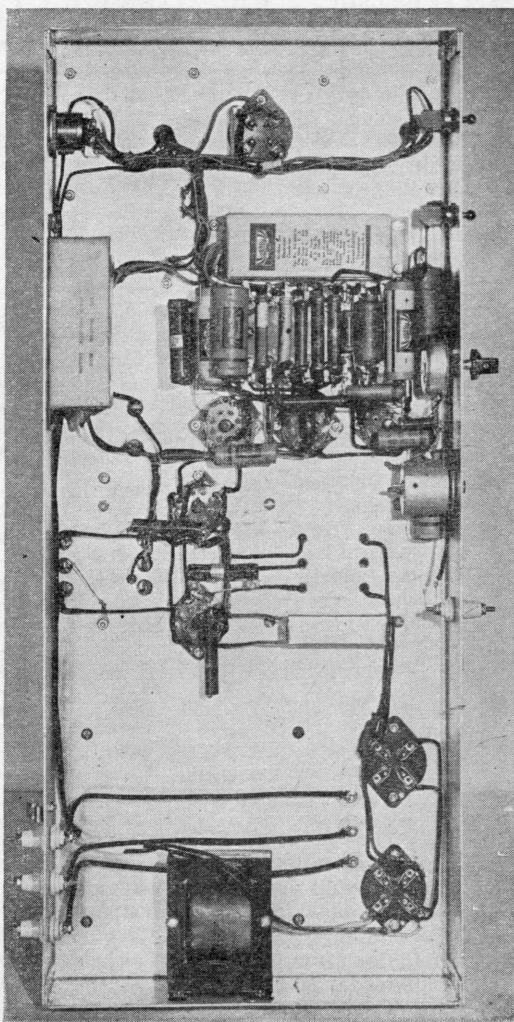
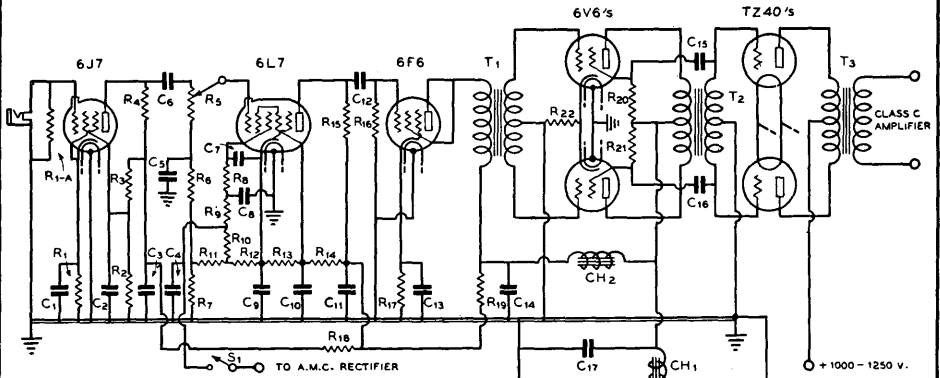
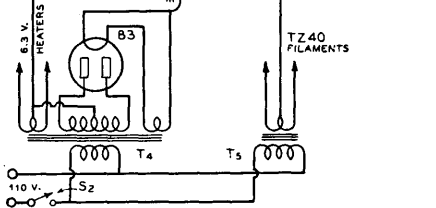

FIGURE 38. THE TZ40 MODULATOR TIPPED UP ON EDGE TO SHOW THE POSITION OF THE COMPONENTS UNDER THE CHASSIS.

FIGURE 39. GENERAL WIRING DIAGRAM OF THE TZ40 MODULATOR AND ASSOCIATED A.M.C. SPEECH AMPLIFIER.



- C₁—10- μ fd. 25-volt tubular
- C₂—25- μ fd. 400-volt tubular
- C₃—4- μ fd. 450-volt electrolytic
- C₄, C₅—0.5- μ fd. 400-volt tubular
- C₆—0.2- μ fd. 400-volt tubular
- C₇—0.1- μ fd. 400-volt tubular
- C₈—0.02- μ fd. 400-volt tubular
- C₉—8- μ fd. 450-volt electrolytic
- C₁₀—0.5- μ fd. 400-volt tubular
- C₁₁—8- μ fd. 450-volt electrolytic
- C₁₂—0.5- μ fd. 400-volt tubular
- C₁₃—10- μ fd. 25-volt tubular
- C₁₄—8- μ fd. 450-volt electrolytic
- C₁₅, C₁₆—8- μ fd. 450-volt electrolytic
- C₁₇—8- μ fd. 450-volt electrolytic
- R₁—1000 ohms, 1 watt
- R_{1A}—5 megohms, 1/2 watt
- R₂—50,000 ohms, 1 watt
- R₃—500,000 ohms, 1 watt
- R₄—250,000 ohms, 1 watt
- R₅—500,000-ohm potentiometer
- R₆—500,000 ohms, 1 watt
- R₇—4500 ohms, 5 watts
- R₈—1 megohm, 1 watt
- R₉—100,000 ohms, 1 watt
- R₁₀—500,000 ohms, 1 watt
- R₁₁—350 ohms, 1 watt
- R₁₂—150 ohms, 1 watt
- R₁₃—5000 ohms, 5 watts
- R₁₄—7500 ohms, 5 watts
- R₁₅—100,000 ohms, 1 watt
- R₁₆—100,000 ohms, 1 watt
- R₁₇—750 ohms, 10 watts
- R₁₈—10,000 ohms, 5 watts
- R₁₉—2000 ohms, 5 watts
- R₂₀, R₂₁—5000 ohms, 3 watts
- R₂₂—300 ohms, 10 watts
- T₁—Triode power tube to p.p. power tube driver trans-
- T₂—former
- T₃—Multi-match class-B input transformer.
- T₄—Multi-match class-B output (300 watt)
- T₅—745 c.t., 145 ma.; 5 v. 3 a.; 6.3 v., 4.5 a.
- T₆—7.5 volts, 4 amperes
- CH₁—10-hy., 150-ma. filter choke
- CH₂—10-hy., 65-ma. filter choke
- S₁—A.m.c. on-off switch
- S₂—110-v. a.c. switch



- T₂—former
- T₃—Multi-match class-B input transformer.
- T₄—Multi-match class-B output (300 watt)
- T₅—745 c.t., 145 ma.; 5 v. 3 a.; 6.3 v., 4.5 a.
- T₆—7.5 volts, 4 amperes
- CH₁—10-hy., 150-ma. filter choke
- CH₂—10-hy., 65-ma. filter choke
- S₁—A.m.c. on-off switch
- S₂—110-v. a.c. switch

bilities at 1250 volts, the plate-to-plate load value should be 7400 ohms; the unit would be capable of fully modulating 600-watts input and the plate current would kick up to 175 to 225 ma. under full modulation.

If it is desired to operate the class-B

stage under the conventional conditions for maximum *sine-wave* audio output, the plate-to-plate load resistance would be 6800 ohms under the 1000-volt conditions; the power output would be 175 rated watts and the plate current would kick up to 250 to 275 ma. on peaks.

CHAPTER 16

U. H. F. Communication

Construction of Transmitters and Receivers—Designing and Building Stabilized Oscillators — Microwaves — Crystal Control—U. H. F. Measurements

THE very-high frequency or *ultra-high frequency* range may be said to extend from 30 megacycles (10 meters) to infinity. Frequencies higher than 300 Mc. (1 meter in wavelength) are usually classed as *microwaves*. The microwaves extend into the region of heat wavelengths, thence into the wavelengths of light. Amateur operation is permissible for both voice and c.w. communication in the ranges 56 to 60 Mc., 112 to 118 Mc., 224 to 230 Mc., 400 to 401 Mc. and 401 Mc. and beyond. The limits of the 112- and 224-Mc. bands become effective April 13, 1939.

The speed of light and radio waves is approximately 300,000,000 meters per second. In order to show the relation between frequency and wavelength of radio waves, the following formulas are given:

$$F = \frac{300,000,000}{\lambda}$$

or—

$$\lambda = \frac{300,000,000}{F}$$

where F is the frequency in cycles per second,

λ is the wavelength in meters,
or—

$$\lambda = \frac{300}{f}$$

where f is megacycles per second.

Very short radio waves behave very much like light waves and are not often reflected or refracted by the Heaviside layer. These radio waves are most useful over quasi-optical paths, i.e., between points which are nearly in visual range

with one another. The wavelength used for radio communication in the u.h.f. range, however, is thousands of times greater than that of light; there is a greater curvature of the paths of the radio waves. For this reason the range is somewhat greater than can be obtained by means of light rays, and signals can, therefore, be received from points beyond the horizon. The range of transmission is governed by the height of the transmitting and receiving antennas. Objects that lie in the path of the transmitted wave introduce a *shadow effect*, which often prevents reception of the transmitted signal. This shadow effect can be overcome to some extent by using higher power in the transmitter.

Occasionally, the radio waves in the range of 56 to 60 Mc. are reflected back to earth by the Heaviside layer with the result that these signals can be heard over distances of a few hundred, or even a few thousand, miles. This type of long-distance communication is extremely erratic, and the practical service of the ultra-high frequencies lies in the short-distance visual range. The occasional reflection of 5-meter signals from the Heaviside layer seems to depend upon sun spot activity and the season of the year, as well as the time of day. At distances somewhat beyond the horizon, reception is often erratic because the atmosphere changes its temperature in layers close to the earth which, in turn, may change the amount of refraction of the 5-meter signals. Refraction bends the radio waves into a curve along the earth's circumference and, therefore, increases the range of the radio wave beyond the optical distance.

Very little transmitter power is re-

quired for communication in the u.h.f. range over optical distances. The following formula can be used for calculating the optical range of transmission and reception:

$$X = \frac{2 d^2}{3}$$

where

X = height of the u.h.f. antenna in feet,

d = distance in miles.

This empirical formula can be used to calculate the height of an antenna in order to obtain any given distance of transmission to the optical horizon (in level country). If the receiving antenna is also located at some height above ground, the range will be increased and the same formula can again be used. For example, if the transmitting antenna is located at a height of 75 feet above ground, the transmission range

will be found as follows:

$$75 = \frac{2}{3} \times d^2,$$

thus $d = 10.5$ miles.

If the receiving antenna is 30 feet high, the optical range can be found from the same formula, i.e., $30 = \frac{2}{3} \times d^2$ or $d = 6.7$ miles. The receiving station could, therefore, be located $6.7 + 10.5$ or 17.2 miles from the transmitter and still be within the optical range. In this case, the radio wave will just graze the surface of the earth in reaching the receiving location and would tend to be cancelled at the earth so that the signal at the receiving station would be considerably attenuated. The tendency of u.h.f. waves to be curved along the surface of the earth by refraction compensates for the tendency to be reflected upward from the surface of the earth, so that this range can be maintained, provided that no large objects lie between the transmitter and receiver locations.

U. H. F. TRANSMITTER CONSIDERATIONS

Self-excited modulated oscillators of the type shown in figure 1 are still used for short-range 56-Mc. mobile operation. This type of circuit is typical of those used in low-power transmitters and receivers.

Standard tubes cannot be used in this circuit for wavelengths below 2.5 meters. Special tubes of the acorn type, or those in which the element spacing is very small, can be used in this same type of circuit for wavelengths as low as 0.4 meters (40 centimeters).

Transmitters for fixed station 5-meter service should preferably have a stabilized source of frequency control. The simple modulated oscillator shown in figure 1 is subject to a high degree of frequency modulation and its signals cannot be received on a selective radio receiver. This means that relatively few transmitters of this type can be used simultaneously in the 5-meter band. For this reason, it is suggested that in the general interest the use of such oscillators be confined to 2.5 meters and lower wavelengths where stabilization is not yet practicable.

Stabilized oscillator circuits, such as those described later in this chapter, can be modulated without causing excessive frequency modulation. Crystal control by means of a crystal oscillator and frequency-doubling or tripling stages is the most perfect method of stabilized frequency control for the very-short-wave bands. The relative cost and complexity of circuits of this type have retarded their general use, but the advantages to be obtained more than justify their use, even for mobile operation. Twenty-eight-Mc. crystals have greatly

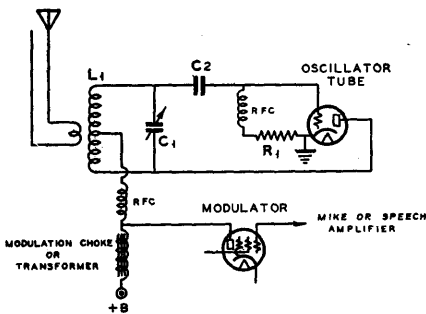

Figure 1. Self-excited modulated oscillator.

simplified the problem of 56-Mc. crystal control.

Transmitters for portable operation can operate successfully with power outputs of one watt or less. Those for mobile operation usually have an output of from 5 to 10 watts; fixed amateur

stations commonly use power outputs varying from 5 to 30 watts. Experimental and commercial stations require higher outputs; values of several kilowatts are desirable for reliable general coverage over a radius of 25 or 30 miles.

U. H. F. RECEIVER CONSIDERATIONS

Radio and television receivers for the u.h.f. region vary in design from simple one-tube radio receivers up to as many as 25 or 30 tubes in a television receiver. In the more complex types of u.h.f. radio receivers, the superheterodyne circuits are quite similar to those used in the short-wave and broadcast ranges. The design of tuning coils and inductances is somewhat different if they are to function successfully in the u.h.f. range. U.h.f. receivers of several types are described in *Chapter 8* and later in this chapter.

Superregeneration

Regeneration carried beyond the point of oscillation, called *superregeneration*, is used extensively for reception of radio waves in the range of from 10 down to ½-meter. Superregeneration is accomplished by allowing the detector to oscillate, then damping out the oscillations a great many times per second (at a rate above audibility). This increases the sensitivity of the detector to an enormous degree for weak signal reception. Superregeneration becomes more effective at higher frequencies, and since the selectivity of a superregenerative receiver is very poor in comparison with ordinary regeneration, this type of receiver can be used successfully to receive the simple modulated oscillator transmitter signals which are so common in the u.h.f. range.

Superregeneration can be obtained by means of a blocking-grid-leak action, as shown in figure 2, or by means of a separate low-frequency oscillation applied to the grid or plate of the detector, as shown in figure 3. The circuit in figure 2 can be used as a blocking-grid-leak type of superregenerator by choosing the values of C_a , R_1 and C_1 in such a manner that the u.h.f. oscillation is started and stopped at a rate above audibility. This circuit functions as an

IMPORTANT NOTE

A few broad signals from unstabilized oscillators can clutter up the entire 56-Mc. band. While simple, unstabilized oscillators are the least expensive and easiest to get going, the use of such oscillators on 56 Mc. is obviously unfair to those amateurs who have spent considerably more time and money to construct stable transmitters for this band.

It is suggested that for the common good the use of both unstabilized transmitters and superregenerative receivers not having an r.f. stage to suppress receiver radiation be confined to the 112-Mc. (2.5 meter) band. Communication on this band is substantially as satisfactory as on 56 Mc., and as most receiving tubes can be made to work on 112 Mc. without resorting to special circuits, it is merely a matter of popularizing the use of this band. The only objection in the past to the use of the 112-Mc. band has been that there are no amateurs on that band with whom to work. This in itself is a good reason for encouraging occupancy of this band, as it is to the interest of amateurs to make use of all frequencies delegated to their use.

Most of the simple 56-Mc. mobile transceivers now in use utilizing superregenerative receivers with no r.f. stage and an unstabilized oscillator as the transmitter can be made to work on 112 Mc. simply by cutting down the coils. By using a 112-Mc. half-wave vertical radiator, which is no longer physically than the popular 56-Mc. Marconi ordinarily used for mobile work, it is possible to cover approximately the same distances on the higher frequency as on 56 Mc.

In the construction portion of this chapter is shown a simple transceiver that works very well on either 56 or 112 Mc. It is strongly advised that the transceiver be used only on 112 Mc. except in locations far removed from large centers of population.

Figure 2. Fundamental u.h.f. receiver circuit.

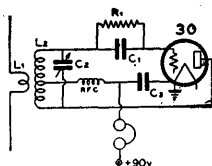

ordinary oscillator in which the resistance of the grid leak is too high to permit the electrons on the grid to leak off at a rate that will give constant value of grid-bias voltage. This blocking action causes a change in the average grid bias and stops the u.h.f. oscillation because the plate current is decreased and the mutual conductance of the tube also decreases during the blocking action. If the circuit constants are correct, this blocking action takes place at an inaudible high-frequency rate and superregeneration is accomplished.

Damping or Quenching Action

Damping or quenching action can be obtained by means of a separate oscillator which functions at some inaudible frequency, such as 100,000 cycles per second, as shown in figure 3. The interruption-frequency circuit consists of an oscillator tuned to about 100,000 cycles per second, connected so that this oscillation modulates the d.c. plate supply to the u.h.f. detector. The latter is an ordinary oscillator which is made superregenerative by means of the interruption-frequency oscillator. The in-

terruption-frequency voltage varies the detector plate voltage to such an extent that the detector goes in and out of oscillation at a rate determined by the interruption-frequency oscillator circuits,

Fairly heavy antenna loading or coupling is required in either circuit in order to obtain good audio quality and sensitivity. Too much antenna coupling will pull the detector out of superregeneration. The antenna system can be either inductively or capacitively coupled to the detector tuned circuit or to an r.f. amplifier preceding the detector. Superregenerative detectors connected directly to an antenna radiate a signal fully modulated by the quenching frequency and thereby cause bad interference in other receivers for a radius of several miles. The blocking-grid-leak detector is more troublesome in this respect, and, in either case, a radio-frequency amplifier should be connected ahead of the superregenerative detector in order to eliminate or minimize receiver radiation into the antenna system.

A. V. C. Effect

A superregenerative detector has an automatic volume control effect, in that it has high sensitivity to weak signals and low sensitivity to strong signals. This action greatly reduces automobile ignition interference, since the latter is usually of very strong intensity, but fortunately of short time amplitude. The detector sensitivity automatically drops down during the small fraction of a second in which this noise impulse is present, and, although the desired signal is also reduced, the human ear will not respond to changes of such short duration. The ignition interference, therefore, does not cause an excessively loud signal in the audio output as compared with the strength of the desired phone signal. The high sensitivity of a superregenerative detector, when no carrier signal is present, results in a loud audible hiss or rushing sound in the output circuit and is due to thermal and contact noise in the detector circuit. A fairly strong carrier signal automatically reduces the sensitivity of the detector and, consequently, reduces the background noise or hiss; a strong signal will completely eliminate the background noise.

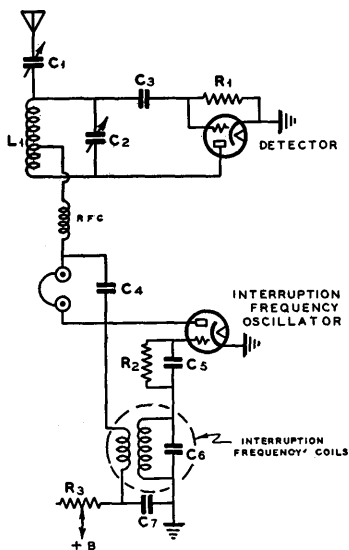

Figure 3. U.h.f. receiver circuit with separate quench oscillator.

ANTENNA SYSTEMS

Many types of antenna systems can be used for u.h.f. communication. Simple, non-directive half-wave vertical antennas are desirable for general transmission and reception in all directions. Point-to-point communication is most economically accomplished by means of directional antennas which confine the energy to a narrow beam in the desired direction. If the power is concentrated into a narrow beam, the *apparent* power of the transmitter is increased a great many times.

The useful portion of a signal in the u.h.f. region for short-range communication is that which is radiated in a direction parallel to the surface of the earth. A vertical antenna transmits a wave of low-angle radiation which is vertically polarized. For best results, vertical receiving antennas should be used to receive signals from a vertical transmitting antenna.

Vertically-polarized radio waves are not easily reflected upward by the surface of the earth as are horizontally-polarized waves. Horizontal antennas can be used to advantage during the occasional periods in which the 5-meter signals are reflected from the Heaviside layer.

The antenna system for either transmitting or receiving should be as high above earth as possible and clear of nearby objects. Transmission lines, consisting of concentric-line or spaced two-wire lines, can be used to couple the antenna system to the transmitter or receiver. Nonresonant transmission lines are more efficient at these frequencies than those of the resonant type.

Antenna design data, charts, tables and graphs for simple and complex antennas and arrays are covered in the chapter on *Antennas*.

WAVELENGTH OR FREQUENCY DETERMINATION

Transmitter and receiver frequency or wavelength checking can be accomplished by means of parallel-wire measurements (Lecher wire system), by wavemeters or by means of harmonics from a crystal or calibrated low-frequency oscillator. The parallel wire or Lecher wire system is very easily applied to wavelength measurements in the microwave region.

Lecher Wire Systems

A Lecher wire measuring system consists of a pair of parallel wires, short-circuited at one end in order to provide a pickup loop which can be coupled to the tuned circuit of the transmitter or receiver. The energy induced into the parallel wires establishes standing waves of voltage and current along the wire, and these standing waves can be located with a sliding bar or copper wire, as shown in figure 4.

A single sliding bar can be moved along the parallel wires until two successive points are located which produce

a change in the oscillator plate or grid current, or in the receiver noise level when the pickup loop of the parallel wire system is inductively coupled to the circuit under test. The distance between these two points is a half wavelength, and this value can be converted from feet or inches into the wavelength in meters by multiplying the number of feet by 0.656 or the number of inches by 0.0547.

For microwave measurements, the distance between half-wave points is usually measured in inches and converted to wavelength in centimeters by multiplying the number of inches by

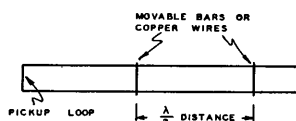

LECHER WIRE SYSTEM

FIGURE 4.

5.47. This conversion factor takes into consideration the conversion into the metric system and the fact that the distances are a half-wave apart. The result is the actual wavelength of the oscillator. An accuracy of approximately 1 per cent can be expected; for more accurate frequency or wavelength determination, the harmonic method should supplement these measurements.

A Lecher wire system suitable for measurement of wavelengths below one meter can be made by stretching two no. 12 bare copper wires approximately 1-inch apart. Each wire has a length of about 50 inches; this length will depend upon the wavelength being measured. Lengths of 35 to 40 feet will be necessary for 10-meter measurements. The spacing between wires can be as much as 3 or 4 inches for wavelength measurements above 10 meters.

A Lecher wire system can consist of a long wooden framework and some means of clamping or stretching the two parallel wires to prevent sag or change in wire spacing. No supports or insulators should be connected to the parallel wires in the actual measuring range between the two half-wave points over which the sliding bar is moved.

range of from 4 to 14 meters can be made with a 150- μ fd. variable condenser connected across a 2-turn coil, 2 inches in diameter. The coil should be supported on bakelite spacers. Hand-capacity effects can be eliminated by tuning the condenser with a bakelite extension shaft. A two-turn coil, approximately $\frac{5}{8}$ -inch diameter, tuned with a 15- μ fd. condenser, will cover the range of 2 to 3 meters. These absorption-type

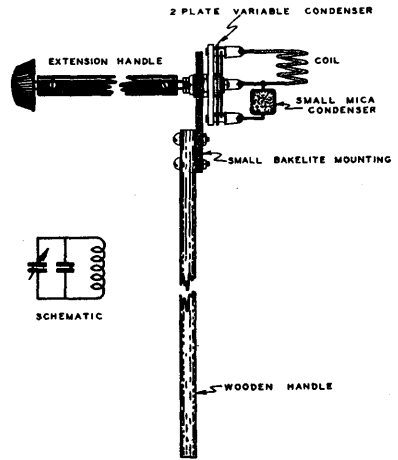

FIGURE 5.

U. H. F. Wavemeters

Absorption-type wavemeters are easily constructed and considerable time can be saved in making oscillator wavelength measurements by this means rather than by Lecher wires. These wavemeters can be calibrated by means of a superregenerative receiver and harmonics from a calibrated low-frequency oscillator or by means of Lecher wire comparative measurements. A simple absorption-type wavemeter which has a range of about 4.5 to 7 meters can be constructed by connecting a 5-turn coil of wire across a 25- μ fd. midget variable condenser which is in parallel with a 20- μ fd. midget fixed condenser as shown in figure 5.

The turns can be squeezed in and out to spot the 5-meter band on the center of the condenser dial and the device then calibrated from known frequencies or Lecher wires. The coil can be wound with no. 10 wire in a winding length of 1-inch and with a diameter of about $\frac{1}{2}$ -inch.

A similar type of wavemeter with a

wavemeters are inductively coupled to the tuned circuit in the transmitter or receiver under measurement. When the wavemeter is tuned to the same frequency or wavelength as that of the oscillator under measurement, a change in plate or grid current will be noted.

The absorption-type wavemeter with a diode indicator, shown in figure 6, is quite useful in the range of 3 to 10 meters. A type-30 tube with a single

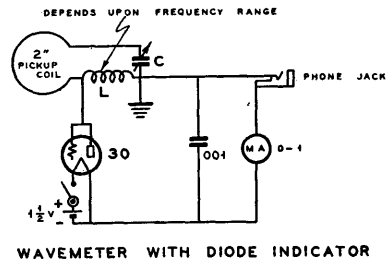

WAVEMETER WITH DIODE INDICATOR

FIGURE 6.

1½-volt flashlight cell for filament supply serves as a diode to rectify the radio-frequency. A 0-1 d.c. milliammeter is connected in series with the diode so as to act as a resonance indicator; a closed-circuit telephone jack enables the device to be used as a monitor for checking the quality of a phone transmitter.

The coil L consists of from 3 to 10 turns, ½-inch diameter, no. 12 wire, spacewound, depending upon the desired range of the wavemeter. The tuning condenser C can have any maximum capacity of from 25 to 50 $\mu\text{pfd.}$, depending upon the desired range of the wavemeter.

Harmonic Frequency Determination

A calibrated low-frequency oscillator, such as a quartz crystal, will provide

an accurate means of frequency determination in the range of from 2 to 10 meters. An oscillating quartz crystal in the 160- or 80-meter amateur bands will produce strong harmonics in the u.h.f. region between 2 and 10 meters. A superregenerative receiver, when tuned to this region (while very loosely coupled to the oscillator), will indicate the harmonics by sharp reductions in hiss level in the receiver output. An absorption wavemeter can be coupled to this receiver and calibrated by this means. More accurate measurements can be made by using an oscillating regenerative receiver or a superheterodyne receiver equipped with a beat-frequency oscillator. Such receivers can be tuned to zero-beat with the harmonics, and then to the u.h.f. oscillator or transmitter for accurate frequency determination.

MICROWAVE TRANSMITTERS, RECEIVERS

Microwaves, as previously related, are those whose length is less than one meter. Microwaves are generated by means of *magnetrons*, *electron-orbit oscillators* and *regenerative oscillators*. Microwaves are used by broadcast stations for remote pickup, by amateurs and experimenters and for occasional telegraph and telephone communication such as the British channel-spanning system. The technical problems encountered in this field are numerous, yet new tubes designed for microwaves have simplified many of these problems and have been instrumental in increasing the usefulness of the band.

The Magnetron Oscillator

The magnetron is a specially designed tube for very-short-wave operation. It consists of a filament or cathode between a split plate, as shown in figure 7.

A magnetic field is produced at the filament by means of a large external field coil which is energized by several hundred watts of d.c. power. Ultra-high-frequency oscillations are produced in the split-plate circuit when this magnetic field is in the correct direction and of the proper intensity. A parallel-

wire tuned circuit can be used for wavelengths below one meter or instead of ordinary tuned circuits for wavelengths above one meter. This type is available for experimental purposes and will produce outputs of several watts. The frequency stability is not very good and it is difficult to obtain satisfactory voice modulation from magnetron oscillators.

Electron Orbit Oscillator

The range of oscillation in ordinary circuits is limited by time required for electrons to travel from cathode to anode. This transit time is negligible at low frequencies, but becomes an im-

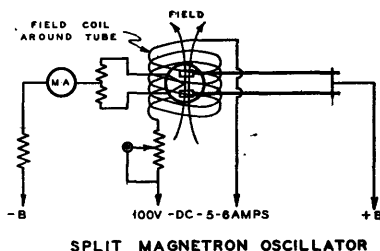

FIGURE 7.

portant factor below 5 meters. With ordinary tubes, oscillation cannot be secured below 1 meter, but by means of *electron orbit oscillators*, in which the grid is made positive and the plate is kept at zero or slightly negative potential, oscillation can be obtained on wavelengths very much below 1 meter.

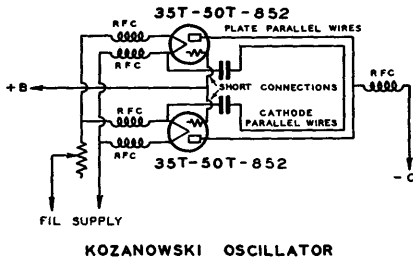

FIGURE 8.

Parallel-wire tuning circuits can be connected to these tube oscillators in order to increase the power output and efficiency. The tubes most suitable for this type of operation have cylindrical plates and grids, and their output is limited by the amount of power which can be dissipated by the grids. For transmitting, tubes such as the 35-T, 50-T or 852 can be used in the circuit shown in figure 8, which is a modification of the *Gill-Morrell oscillator*. More output is obtained by using a tuned-cathode circuit instead of tuned-grid circuit. Modulation can be applied to either the plate or grid. The frequency stability is very poor. The circuit in figure 8 is an early

MICROWAVE TUBE CHARACTERISTICS

RCA 954 PENTODE	
Heater voltage	6.3
Heater current	0.15 amp.
Grid-to-plate capacitance	0.007 μ fd.
Input capacitance	3 μ fd.
Output capacitance	3 μ fd.
Max. plate voltage	250 volts
Max. screen voltage	100 volts
Grid voltage	-3 volts
Suppressor	tied to cathode
Amplification factor	over 2000
Plate resistance	over 1.5 megohm
Mutual conductance	1400 μ hos.
Plate current	2 ma.
Screen current	0.7 ma.
RCA 955 TRIODE	
Heater voltage	6.3
Heater current	0.15 amp.
Max. plate voltage	180 volts
Max. plate current	7 ma.
Amp. factor	25
Plate resistance	12,500 ohms
Mutual conductance	2,000 μ hos.

type oscillator of this general classification.

Regenerative Oscillators

The introduction of the RCA Acorn 955 and Western Electric 316-A tubes made $\frac{1}{2}$ -meter regenerative oscillators practical. These tubes are more efficient than ordinary types for ultra-high-frequency work. Figure 10 illustrates the RCA acorn triode. It is satisfactory for low-power transmitter and superregenerative receivers. The 955 acorn can be used as an oscillator in superheterodyne receiver circuits with its companion tube, RCA 954 (or its variable- μ version, the 956) acorn pentode, in the r.f. portions of the circuit. The regenerative circuits are quite similar to those for longer wavelengths, except for the phys-

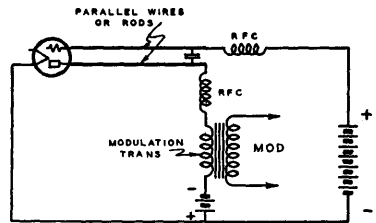

B-K OR G-M OSCILLATOR

FIGURE 9.

ical size of condensers and coils. The tube element spacing in these acorn tubes is made so small that electron transit time becomes a negligible factor for wavelengths above 0.6 meter.

W. E. 316-A Microwave Oscillator

The W. E. 316-A is a microwave triode which delivers from 5- to 10-watts output on wavelengths as low as $\frac{1}{2}$ meter. The element spacing is so close that the

W. E. 316-A CHARACTERISTICS	
Filament voltage	2 volts a.c. or d.c.
Filament current	3.65 amps.
Average thermionic emission	0.45 amp.
Amplification factor	6.5
Plate-to-grid capacitance	1.6 μ fd.
Grid-to-filament capacitance	1.2 μ fd.
Plate-to-filament capacitance	0.8 μ fd.
Max. plate dissipation	30 watts
Max. d.c. plate voltage	450 volts
Max. d.c. plate current	80 ma.
Max. d.c. grid current	12 ma.

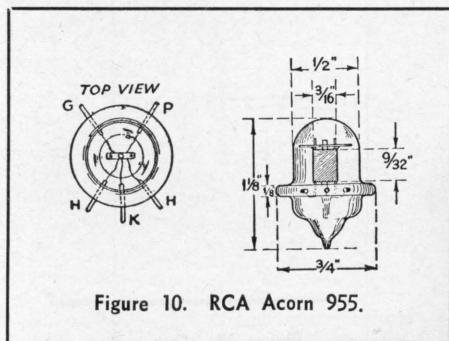

Figure 10. RCA Acorn 955.

tube operates efficiently as a regenerative oscillator with negative grid and positive plate for frequencies as high as 750 Mc. The maximum plate dissipation is 30 watts.

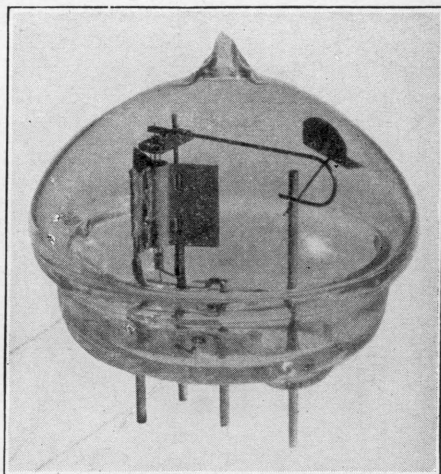

Figure 11. W. E. 316-A u.h.f. triode.

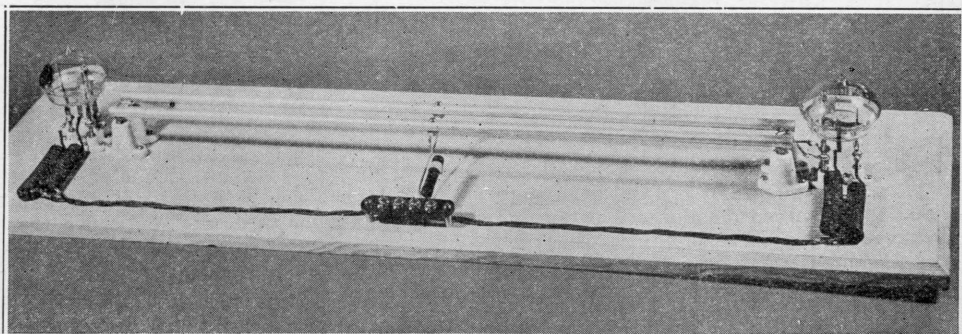

Figure 12. Typical 1/4-Meter Parallel Rod Push-Pull Oscillator Using W.E.316-A's.

Constructing Microwave Equipment

(See also Chapter 8)

1-10 M. SUPERREGENERATIVE RECEIVER

Figures 13 and 14 illustrate a practical u.h.f. and microwave receiver which gives moderate loudspeaker volume with either 135- or 180-volt plate supply. A type 955 acorn triode serves as a super-regenerative detector which is transformer-coupled to a high-gain 6V6G beam power pentode. The latter is similar to the 6L6G, except for its smaller size; it also requires less heater and plate current.

Five self-supporting coils of no. 14

enameled wire cover the range of from 1 to 11.8 meters by means of a 15- μ fd. tuning condenser. The coils plug into pin-jacks mounted in a strip of Victron, 1 1/4"x2". This strip is fastened to the 2"x4" bakelite subpanel by means of a pair of 2-inch 6-32 machine screws. This method of support brings the ends of the tip-jacks directly against the terminals of the u.h.f. variable condenser. The stator lead connects to the plate terminal of the acorn tube socket by means

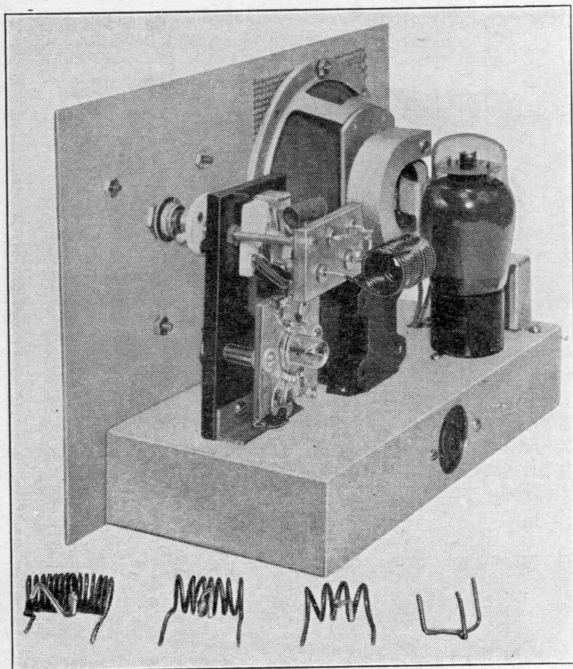

Figure 13. One-to-ten-meter superregenerative receiver with loud-speaker output. A feature of this receiver is the almost complete absence of r.f. connecting leads. Note arrangement and assembly of tube socket and coil holder.

of a wire approximately $\frac{1}{4}$ -inch long. The grid condenser is an extremely small mica fixed condenser, connected between the grid terminal of the tube socket and the rotor lead of the tuning condenser.

The tuning condenser is driven by a vernier dial through an insulated coupling and extension shaft to the front panel. The tube socket is mounted on standard socket bushings, secured to the same bakelite panel that supports the tuning condenser and coil. The cathode and one side of the heater of the 955 tube connect directly to the metal chassis by means of a soldering lug attached to one of the mounting screws on the subpanel.

A .006- μ fd. mica condenser connects to one of the pin-jacks and to the same ground point on the chassis, so as to provide a short r.f. lead between the tap on the coil and the cathode terminal on the tube socket. This tap is used only on the two coils which cover the longer wavelengths. The coils which tune from 1 to 4.4 meters are center-tapped and plug into the other pin-jacks in order to connect the small r.f. choke into the circuit. This choke consists of 25 turns of no. 24 d.c.c. wire, closewound and self-

supporting, $\frac{1}{4}$ -inch in diameter. The choke is soldered directly to the two pin-jacks which are used only for the coil taps. The two lower pin-jacks connect to the tuning condenser and to the outer leads of the coils.

The r.f. choke has a natural period of about 7 meters and must be short-circuited when the large coil (6.5 to 11.8 meters) is plugged in. This is accomplished by soldering a length of no. 14 wire to the cathode tap of the coil, so that the coil plugs into all four pin-jacks. The illustration in figure 13 shows how this method of connection is made.

An audio volume control regulates the gain of the beam-power amplifier and a 100,000-ohm potentiometer controls the superregeneration for the type 955 tube. A small 20- or 30-henry choke is shunted across the magnetic loudspeaker terminals in order to provide a path for most of the d.c. plate current through the 6V6G tube.

This receiver will not superregenerate over the entire tuning range with the one-turn coil for 1-meter reception because the capacitance-to-inductance ratio becomes too great for condenser settings of more than approximately half scale.

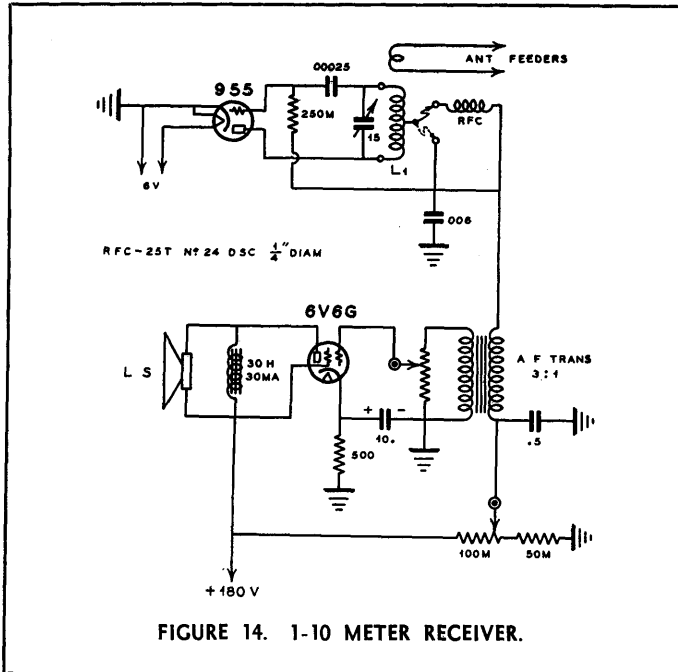

However, the coils are designed so that ample overlap is obtained in order to secure superregeneration over the complete range of from 1 to 10 meters.

Coil Data

The coil which covers the range of from 1 to 1.7 meters consists of slightly less than one full turn of no. 14 enameled wire. The actual wire length is approximately one inch from tip-jack to tip-jack and is *not* plugged all the way into the tip-jacks. If this coil is pushed clear into the pin-jacks, so that the cathode tap to the r.f. choke coil is flush with the tip-jack, the range is from 0.9 to approximately 1.6 meters. The range of from 1.7 meters to 2 meters is covered with a 4-turn coil, with a tap near the center for connection to the r.f. choke coil. This coil is spacewound to one inch length and has an inside diameter of $\frac{3}{8}$ in.

A 7-turn coil of the same diameter and length covers the range of from 2.5 meters to 4.4 meters. This coil is tapped near the center and the tap plugs into the r.f. choke pin-jack. A 14-turn coil, $\frac{3}{8}$ -in.-dia., $1\frac{1}{4}$ in. long, tunes from 4 meters up to 6.8 meters. This coil is

tapped at the 6th turn from the grid end of the coil, and the tap plugs into the cathode by-pass pin-jack. The largest coil consists of 14 turns, $\frac{3}{8}$ in. inside diameter, $1\frac{1}{8}$ in. long, tapped at 5 turns from the plate end and 6 turns from the grid end. The upper jacks are connected in such a manner as to short-circuit the r.f. choke. The tuning range of this coil is from 6.5 to 11.8 meters. The exact dimensions of the coils and locations of the taps will depend upon the physical layout of the r.f. circuit components. Enameled or bare no. 14 copper wire should be used in preference to tinned wire because of the lower r.f. resistance at the higher frequencies. Tinned wire has a much greater *skin effect* loss and should be avoided in all ultra-high-frequency receivers and transmitters.

Chassis

The chassis is 5"x9"x1 $\frac{1}{2}$ ", of no. 14 gauge aluminum, with a 12-gauge aluminum front panel 7"x11". The cathode by-pass condenser, cathode resistor for the 6V6G tube and the regeneration control by-pass condenser and 50,000-

ohm resistor are mounted under the chassis.

It is recommended that the receiver not be used below 60 Mc. (above 4

meters) when in the vicinity of other amateurs, as the receiver radiates sufficiently to cause bad QRM in the 5- and 10-meter bands over a radius of about one mile.

STABILIZED SELF-EXCITED 5-M. TRANSMITTER

The 5-meter stabilized transmitter illustrated in figures 15 and 16 affords a degree of frequency stability vastly better than that of conventional 5-meter self-excited oscillators using solenoid inductances. While the stability is of course not comparable to that provided by crystal control, it is sufficiently good for phone operation* except in crowded districts where there are a large number of 56-Mc. amateurs in a small area. While the use of crystal control is strongly advised for 56-Mc. operation regardless of location, because of the advantages other than the interference reduction that it affords, it is realized that a certain number of amateurs will continue to use self-excited oscillators. It is for these amateurs who insist upon using self-excited 5-meter transmitters that this transmitter is presented.

Frequency stability is obtained by means of a high-Q tuned circuit, in conjunction with a variable grid coupling condenser. These two factors minimize the effect of changes in plate voltage in the oscillator during the process of modulation. Proper adjustment of the grid-control condenser results in an oscillator which has a frequency stability comparable to that of a high-Q parallel-rod oscillator. An increase in d.c. plate voltage of from 225 up to 350 volts caused a frequency change of less than 5,000 cycles when this oscillator was under test; the usual 5-meter oscillator has a frequency change of from 60 to 100 kc. under these test conditions. The tests were made by listening to the beat note in a 5-meter c.w. superheterodyne receiver. A d.c. plate voltage drop from the 225-volt value down to 100 volts caused a frequency change of approximately 7 kc.

The oscillator in the transmitter illus-

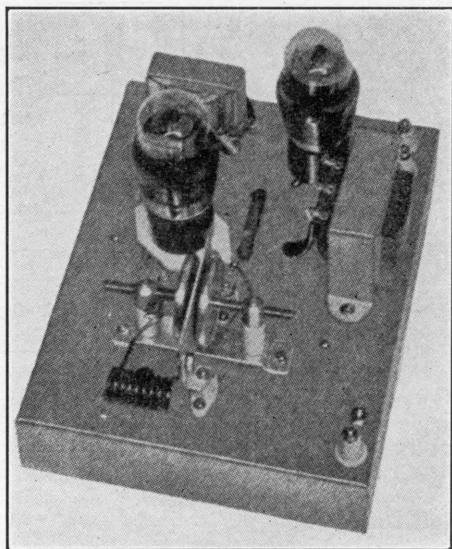

Figure 15. Stabilized u.h.f. oscillator diagrammed in figure 16. Note center plate between adjustable rotors of a standard, small size neutralizing-type condenser. It is of importance that the components be placed precisely as shown.

trated in figures 15 and 16 can be modulated up to 75 per cent without appreciable frequency modulation. The signal can be received with excellent quality on most superheterodyne receivers.

A carrier output of 3 to 5 watts is obtained from this transmitter. A 6L6G tube serves as a modulator, in conjunction with a single-button carbon microphone. A separate 4.5-volt microphone battery allows the use of either a.c. or d.c. heater supply and a.c. or dynamotor plate supply. The total plate current drain is approximately 85 ma. at 300 volts and approximately 120 ma. at 400 volts.

*As we go to press we are informed that the U.S.A. amateur regulations will prohibit the use of modulated oscillators after Dec. 1, 1938.

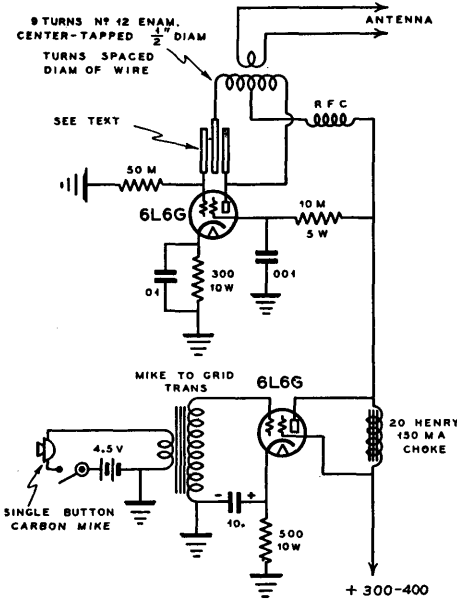

Figure 16. Stabilized 5-meter phone transmitter wiring diagram.

The heart of the transmitter is a special variable condenser made from a standard disc-type neutralizing condenser, to which is added a small rectangular aluminum plate. The disc-type condenser must be of the type having both discs adjustable. One end of the coil connects to the fixed aluminum plate, which is fastened to the chassis by means of small, porcelain, stand-off insulators at either end of the plate; the other end of the coil connects to one of the adjustable plates of the neutralizing condenser. This same lead is also connected to the plate terminal of the 6L6G tube.

The grid of the tube connects to the remaining circular plate of the disc-type condenser. A 50,000-ohm grid leak connects from the grid to the chassis ground. The coil consists of 9 turns of no. 12 enameled wire, center-tapped; this coil is self-supporting and has an inside diameter of slightly more than 1/2 inch. The turns are spaced approximately one wire diameter.

The r.f. choke consists of 80 turns of no. 34 d.s.c. wire, close-wound on a 3/8-inch diameter bakelite rod. This choke is mounted vertically under the coil, the lower end of the coil rod being supported to the chassis by means of a 6-32 machine screw. The .01- μ fd. and .001- μ fd. r.f. by-pass condensers in the oscillator circuit are connected directly from the tube socket terminals to the chassis ground; these condensers are of the mica type. A combination of grid leak and cathode bias provides better frequency stability than grid leak bias alone. The screen and plate circuits of the oscillator are both modulated.

In operation, the circular condenser plate at the plate side of the coil is spaced approximately 1/16 inch from the fixed aluminum plate; the circular plate in the grid circuit should be spaced 1/16 to 1/8 inch from the center fixed plate, depending upon the degree of antenna loading. This plate must be close enough to the stator to supply just sufficient grid excitation for stable oscillation. The position of this condenser plate affects the frequency of operation, so that both condenser plates should be simultaneously adjusted in order to tune the circuit to the desired portion of the 5-meter band. The position of the grid coupling condenser plate is not critical. If resonance is not obtained at approximately the condenser settings noted, the coil turns should be spread or squeezed together slightly as necessary.

5-M. HK54 STABILIZED SELF-EXCITED OSCILLATOR

The stabilized oscillator shown in the photograph and figure 17 is similar to the one used in the transmitter above except that it is designed for higher power. The same considerations dis-

cussed in connection with the oscillator just described also apply to the HK54 oscillator of figure 17.

The tuning condenser is made from a disc-type neutralizing condenser as in

the 6L6G oscillator, but the neutralizing condenser is of a larger size, designed for neutralizing T-200's, 250TH's, etc. The disc plates are approximately 3 inches in diameter.

The coil consists of 7 turns of no. 10 enameled wire, $\frac{3}{4}$ " in diameter and spaced to about $1\frac{1}{2}$ ". It is center-tapped for connection of the r.f. choke.

The combination of grid leak and cathode bias contributes to the frequency stability, which is comparable to that obtained with a parallel rod oscillator.

Rather light antenna loading should be used to keep the plate current down to about 80 ma. at 1000 plate volts. The grid excitation is adjusted for most stable operation by means of the movable disc connected to the grid.

A modulator delivering 25 to 35 watts of audio power can be used with a suitable coupling or modulation transformer for plate modulation of the oscillator. No attempt should be made to modulate the oscillator more than approximately 85 per cent.

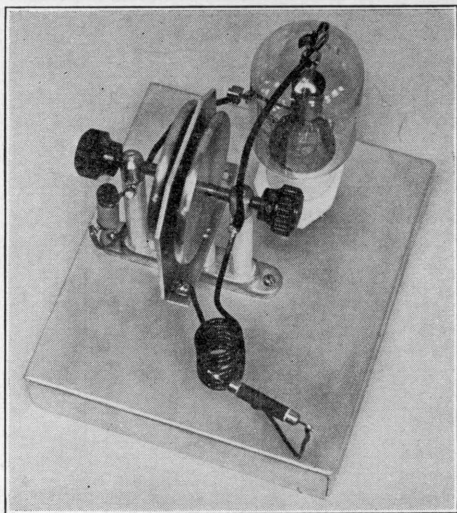

This HK54 stabilized self-excited oscillator delivers over 30 watts output on 5 meters with a 1000-volt plate supply.

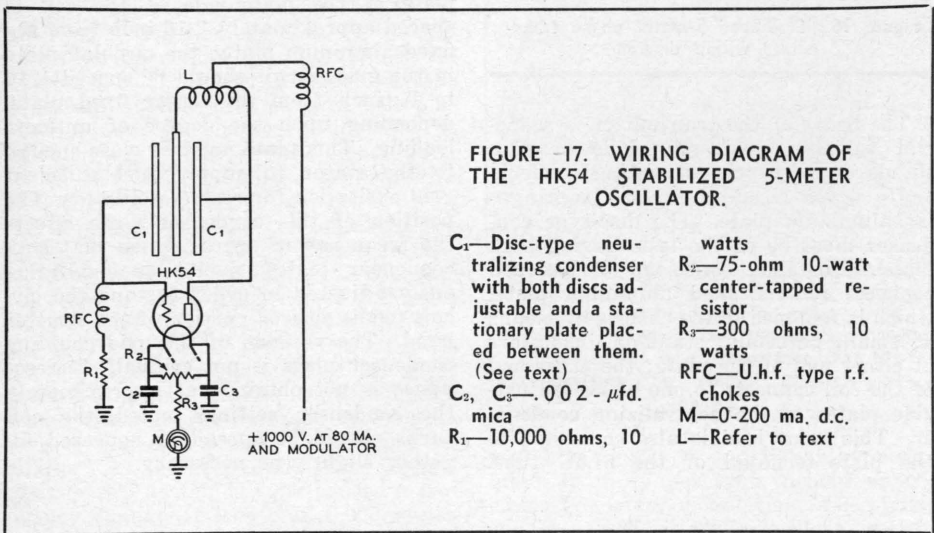

FIGURE 17. WIRING DIAGRAM OF THE HK54 STABILIZED 5-METER OSCILLATOR.

- C₁—Disc-type neutralizing condenser with both discs adjustable and a stationary plate placed between them. (See text)
- C₂, C₃—0.02- μ fd. mica
- R₁—10,000 ohms, 10 watts
- R₂—75-ohm 10-watt center-tapped resistor
- R₃—300 ohms, 10 watts
- RFC—U.h.f. type r.f. chokes
- M—0-200 ma. d.c. L—Refer to text

SIMPLE CRYSTAL-CONTROLLED 5-M. TRANSMITTER

The use of a 10-meter crystal makes it possible to construct a very simple, but highly effective, 5-meter crystal-controlled transmitter using only two stages.

The r.f. unit illustrated in figures 18 and 19 delivers between 3 and 5 watts output when fed from a 300-volt supply. A regenerative 10-meter triode crystal

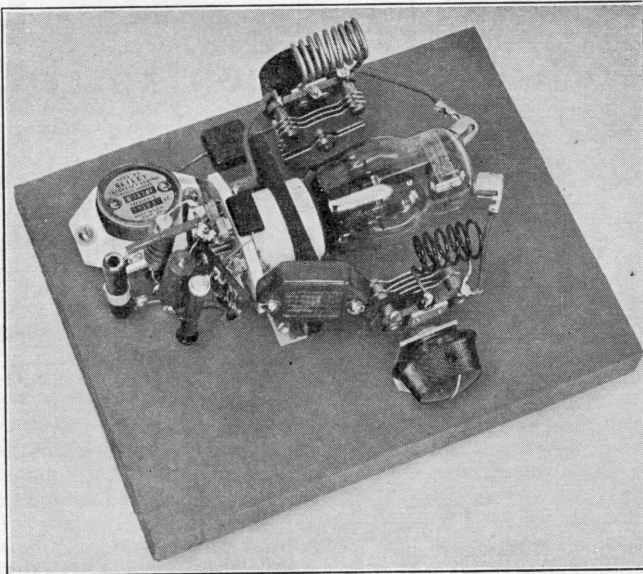

Figure 18. This r.f. unit delivers from 3 to 5 watts on 5 meters when fed from a 300-volt supply. It may be modulated by a single 6V6 or 6L6 for either mobile use or operation at the home station.

oscillator drives a triode doubler, which may be plate-modulated for phone by a single 6V6 or 6L6 (or glass equivalent).

An RK34 dual triode permits a physical layout resulting in very short r.f. leads. This and the high output of the regenerative oscillator largely contribute to the high overall efficiency. The regenerative oscillator is of the type described and discussed in detail in the exciter chapter. It gives very good output with less than 100-ma. r.f. crystal current, which is well within the maximum allowable value for 10-meter crystals.

This unit can be used in conjunction with a modulator for either mobile or stationary operation, or it may be used as an exciter to drive a higher-powered

5-meter amplifier, such as a pair of push-pull 807's.

Both tank circuits are tuned for maximum output. If the total plate current to both sections exceeds 75 ma., the loading on the doubler section is too heavy and should be reduced by using looser coupling.

As the oscillator is fool proof and works well with any 10-meter crystal that will oscillate at all, and as no neutralization of the amplifier is required, the unit is very easy to get working.

The oscillator coil L_1 consists of 9 turns of no. 14 enamelled, $\frac{3}{4}$ " in diameter and spaced $1\frac{1}{4}$ " long. The doubler amplifier coil L_2 consists of 6 turns of the same wire-wound the same diameter, spaced $\frac{3}{4}$ " long.

FIGURE 19. WIRING DIAGRAM OF THE 5-METER TWO-STAGE CRYSTAL-CONTROLLED TRANSMITTER PICTURED IN FIGURE 18.

- | | |
|--|----------------------------------|
| C_1 —0.001- μ fd. midget mica | ceramic insulation |
| C_2 —0.0001- μ fd. mid-get mica | C_6 —0.005- μ fd. mica |
| C_3 —25- μ fd. midget variable | R_1 —25,000 ohms, 1 watt |
| C_4 —0.0005- μ fd. mid-get mica | R_2 —50,000 ohms, 2 watts |
| C_5 —15- μ fd. midget variable, preferably | RFC — Midget 2.5-m.h. r.f. choke |
| | M—0-100 ma. d.c. |
| | L_1, L_2 —Refer to text |

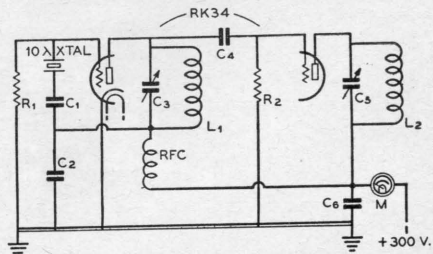

200-WATT 5-10-20-M. CRYSTAL-CONTROLLED TRANSMITTER

While it is practical to construct a transmitter covering from 160 meters down to 10 meters, the tank condenser required for sufficient Q for proper 160-meter operation or even 80-meter operation is too large physically to permit short enough leads for efficient 5-meter operation. For this reason a transmitter that is to be operated on 5 meters should be designed expressly for ultra-high-frequency use.

The crystal-controlled transmitter illustrated in figures 20, 21 and 22 was designed primarily for 5-meter operation, and delivers over 175 watts output as a plate-modulated phone or 225 watts as a c.w. transmitter on 5 meters. By using suitable coils, it is possible to operate the transmitter on 10 and 20 meters, with slightly more output than is obtainable on 5 meters. The tank condensers do not have sufficient capacity to provide enough Q for satisfactory operation on wavelengths longer than 20 meters.

Because the power supply and modulator requirements are the same for a 5-meter transmitter as for a similar transmitter operating on the lower frequency bands, only the r.f. section of the transmitter is described. The final amplifier may be plate-modulated by any

modulator delivering 100 to 125 watts of audio power. A pair of 809's running at 900 volts with 9 volts of battery bias or a pair of TZ40's running zero bias at 900 volts can be used as class-B modulators to deliver the required audio power for complete modulation.

A 400-volt power supply with a divider tapped at 250 volts will serve for the low-power stages. A 1250-volt 350-ma. power supply should be used for the driver and final amplifier. Both power supplies should be well filtered by means of two-section filters.

The crystal oscillator uses a 6C5 in a Pierce circuit. This drives a 6L6G regenerative quadrupler, which derives its regeneration from a skimpy (.0001 μ fd.) cathode by-pass condenser. These two stages always operate on the same frequency: the oscillator on 80 meters and the 6L6G on 20 meters. The latter feeds a neutralized 6L6G which may be used either as a straight amplifier on 20 meters or as a doubler to 10 meters. As it is possible to hit both bands with one coil, no coil changing is required in this stage. The neutralizing condenser consists of a small 3-30 μ fd. mica trimmer having ceramic insulation. The adjusting screw is removed and the movable plate bent in and out until neutral-

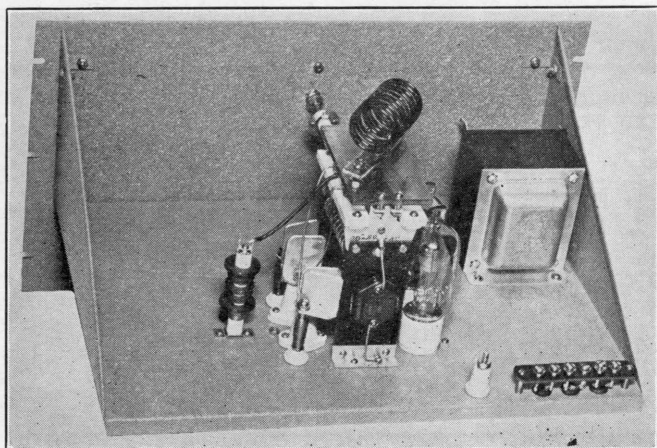
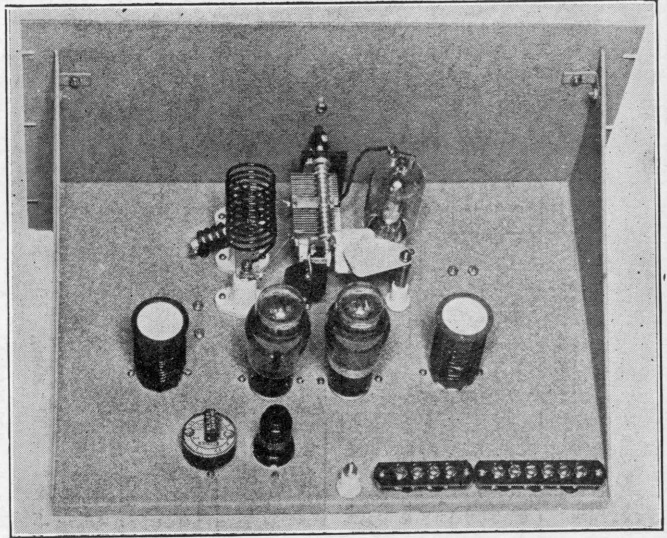

Figure 20. Push-pull final amplifier for the high-power u.h.f. transmitter diagrammed in figure 22. A pair of 35-T's operate with almost uniform efficiency on 5, 10 and 20 meters. The relatively small tank tuning condenser does not have sufficient capacity for operation on lower frequency bands, but permits very short r.f. leads, a necessity for efficient 5-meter operation.

Figure 21. The exciter-driver portion of the high power u.h.f. transmitter consists of an 80-meter Pierce oscillator, a 6L6G regenerative quadrupler, a 6L6G doubler or amplifier and a 35-T doubler or amplifier. The latter is link-coupled to the push-pull final amplifier.



zation is obtained. (Refer to theory chapter for procedure.)

We are now up to the 35-T, which we can excite either on 20 or 10 meters merely by tuning the condenser C_m . The 35-T can be used either as a straight neutralized amplifier on 10 or 20 meters or as a doubler to 5 meters by choosing the corresponding plate coil.

The push-pull 35-T's operate as a straight, cross-neutralized amplifier on any of these bands. The efficiency on 5 meters is practically as good as on the 10- and 20-meter bands. The grid tank coil of the final amplifier is coupled to the driver by means of a one-turn loop at either end of the coupling link. The neutralizing condensers for the final amplifier, as well as the one used for the driver, are homemade; each consists of two, 1-inch square aluminum plates, one plate being made movable by fastening it to a $\frac{1}{4}$ " coil plug, which is plugged into a jack-type feed-through insulator. The jack terminals are wired to the 35-T grids under the shelf, making a very neat installation with very short connecting leads.

The grid tank circuit of the final amplifier is mounted below deck to shield it from the plate tank and to provide short connecting leads to the 35-T grids. The plate tank condenser, a special u.h.f. type that looks like an overgrown mid-gut and is especially efficient at ultra-high frequencies, is raised from the

chassis by means of insulating pillars in order to shorten the leads to the 35-T plate terminals. Because of the short leads, the amplifier neutralizes and operates as well as any 40-meter amplifier.

Both grid and plate tank condensers in the final amplifier stage have Victron strips fastened to them to hold the coil jacks. The construction can best be understood by referring to the photograph of the final amplifier, figure 20. The plug-in coil assembly and method of mounting is the same for the grid tank below chassis as for the plate tank illustrated.

The filament transformer mounted on the final amplifier chassis supplies both the 35-T's in the final amplifier and the 35-T in the exciter portion.

The Coils

The coil problem is greatly simplified because only the 35-T driver and final amplifier coils are changed when changing bands, and because the driver plate, final grid and final plate coils for any one band all have the same number of turns and are interchangeable.

The first 6L6G plate coil consists of 8 turns of no. 16 enamelled wire, $1\frac{1}{2}$ " diameter and $1\frac{1}{4}$ " long.

The second 6L6G plate coil consists of $6\frac{1}{2}$ turns of the same wire, wound $1\frac{1}{2}$ " diameter and $1\frac{3}{4}$ " long, center tapped.

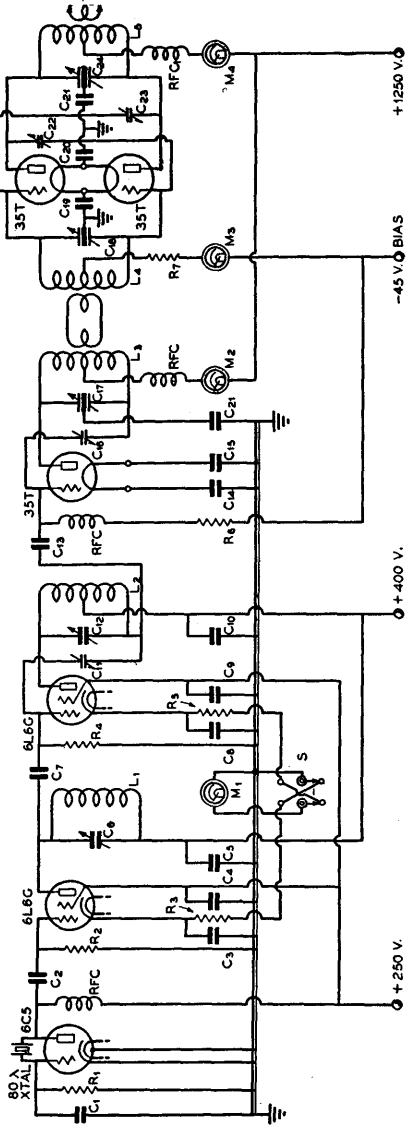

FIGURE 22. GENERAL WIRING DIAGRAM OF THE HIGH-POWER U.H.F. TRANSMITTER.

- C₁, C₂, C₃—0001- μ fd. mica
- C₄, C₅—01- μ fd. tubular
- C₆—50- μ fd. midget variable
- C₇—50- μ fd. mica
- C₈, C₉—01- μ fd. tubular
- C₁₀—002- μ fd. mica
- C₁₁—3-30- μ fd. mica trimmer with screw removed
- C₁₂—100- μ fd. midget variable
- C₁₃—50- μ fd. mica
- C₁₄, C₁₅—001- μ fd. mica
- C₁₆—Homemade neutralizer; refer to figure 21 and text
- C₁₇, C₁₈—35- μ fd. per section, 4200-v. spacing, special u.h.f. condensers
- C₁₉, C₂₀—001- μ fd. mica
- C₂₁—002- μ fd. mica, 2500 v.
- C₂₂, C₂₃—Homemade neutralizing condensers; refer to figure 22 and text
- C₂₄—Same as C₂₁
- R₁—25,000 ohms, 1 watt
- R₂—250,000 ohms, 1 watt
- R₃—300 ohms, 10 watts
- R₄—100,000 ohms, 2 watts
- R₅—300 ohms, 10 watts
- R₆—3000 ohms, 20 watts
- R₇—1500 ohms, 20 watts
- M₁, M₂—0-100 ma. d.c.
- M₃—0-100 ma. d.c.
- M₄—0-500 ma. d.c.
- S—D.p.d.t. switch
- COILS—Refer to text
- RFC—2.5-mh. 125-ma. r.f. chokes
- RFC₁—2.5-mh. 250-ma. r.f. chokes

As already mentioned, the 35-T buffer plate, final grid and final plate coils are identical for any one band, and have the following dimensions:

All coils are wound with no. 10 enamelled wire, are center-tapped, and spaced to 2½" long. 5 meters, 8 turns ⅞" diameter; 10 meters, 10 turns 1½" diameter; 20 meters, 18 turns 1¾" diameter.

The following meter readings are typ-

ical of correct tuning and normal operation:

First 6L6G: 30 ma.

Second 6L6G: 45 ma. (both circuits read with one meter by means of switch S)

35-T buffer: 85 ma.

Final grid: 55 ma. on 5 meters, 65 ma. on 10 and 20 meters

Final plate: 225 ma. phone, 275 ma. c.w.

PARALLEL ROD OSCILLATORS

Push-pull HK-354C U. H. F. High-Q Oscillator

A parallel rod oscillator utilizing two sets of quarter-wave parallel rod tuned circuits is shown in figures 23 and 24. The parallel grid rods act as a high-Q circuit, giving a high degree of frequency stability. These rods are approximately 2¼ feet long for the 2.5-meter band and 4½ feet long for the 5-meter band. The lower ends of the grid rods are connected to a short-circuiting copper plate, and the two grid leads are tapped to the rods a few inches above the copper plate. The plate tuning rods are nearly as long as the grid rods, and a sliding shorting-bar, or connection, tunes this circuit to resonance as indicated by minimum plate current. The oscillator is a tuned-grid-tuned-plate circuit in

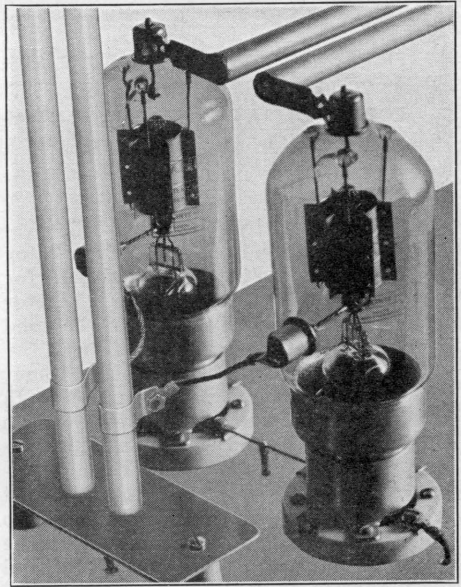
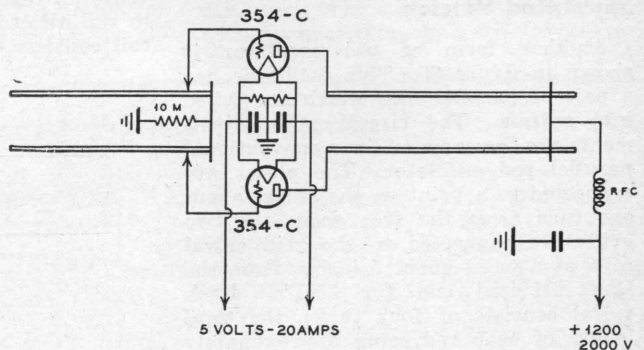

Figure 23. Parallel rod u.h.f. oscillator with HK-354C gammatrons in push-pull.

Figure 24. 2.5 meter oscillator using 354-C gammatrons.



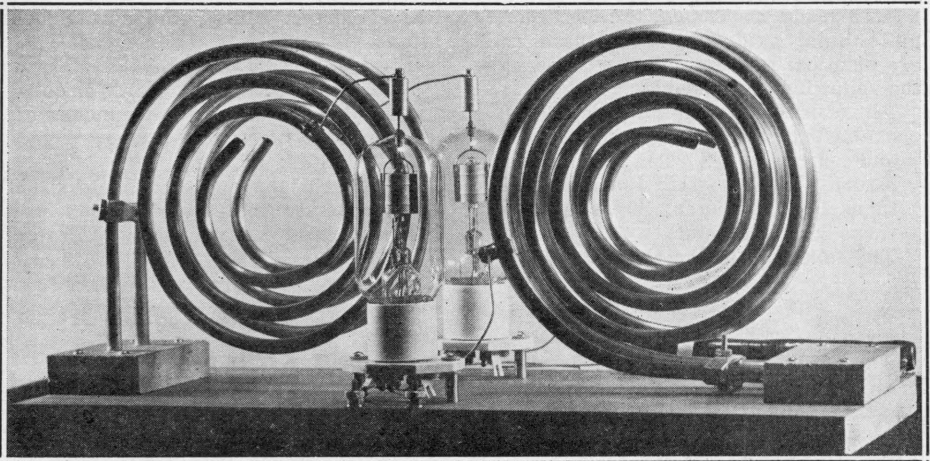

FIGURE 25. THE RODS OF A PARALLEL ROD HIGH-Q U.H.F. TRANSMITTER MAY BE COILED AS IN THIS PUSH-PULL 35-T TRANSMITTER IN ORDER TO OCCUPY LESS ROOM. OPERATION IS SUBSTANTIALLY THE SAME AS IF THE RODS WERE STRETCHED OUT IN A STRAIGHT LINE.

which the grid circuit controls the frequency of operation. The oscillator shown in the illustration is suitable for high-power amateur 2.5- or 5-meter transmitters; smaller tubes can be used if lower power operation is desired.

Plate modulation can be used without excessive frequency modulation, though it is suggested such use be confined to 2½ meters. The antenna can be inductively coupled to the plate rods or directly coupled to the rods through fixed mica condensers which are connected to the rods near the shorting bar. The coupling can be adjusted so that normal plate current is drawn.

Spiral Rod Version

Another form of rod oscillator is shown in figure 25. This oscillator has a pair of parallel rods which are coiled into spirals. The circuit and adjustments are the same as for a conventional parallel rod oscillator. The plates are connected to a point on the spiral about one turn from the free ends; the two grids are connected to the grid spiral coils at a point about 5 inches from the short-circuited end for 35-T's. Each spiral consists of four turns, the total length of each rod being approximately 4.5 feet for 5-meter operation.

2½-Meter RK-34 Parallel Rod Transmitter

An RK-34 twin-triode tube is connected in a tuned-grid-tuned-plate circuit for 2½-meter operation in the transmitter illustrated in figure 27. A parallel rod or wire tuned-plate circuit gives good efficiency on 2½ meters, proved by tests where efficiencies of approximately 50 per cent were realized. A carrier power output of 10 to 15 watts is easily obtainable on 2½ meters. The circuit is shown in figure 26.

A 15,000-ohm grid leak and 300-ohm cathode resistor give stable grid bias for the oscillator. The cathode resistor prevents all tendency for the plate current to run away during operation. The grid coil consists of 5 turns of no. 18 wire,

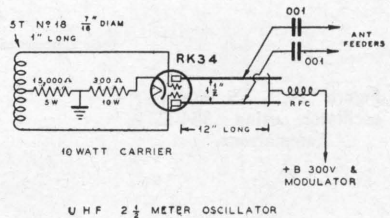
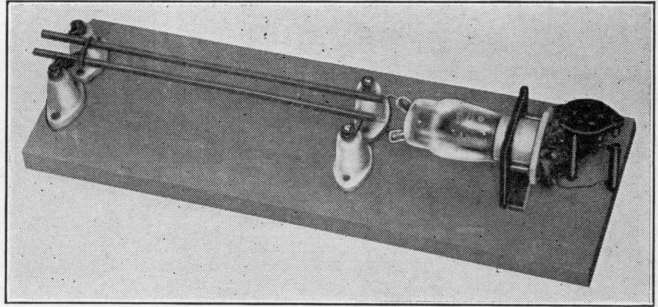

FIGURE 26.

Figure 27. Showing construction of the low-power 2.5-meter oscillator of figure 26. Parallel rods are used to provide a low-loss, high-Q plate tank for the RK-34 dual triode.



wound to cover a length of one inch, with an inside diameter of 7/16 inch. This coil is soldered directly to the tube socket terminals. The antenna feeders can be capacitively coupled to the plate circuit through a pair of .001- μ fd. mica condensers. If a two-wire spaced feeder is used, these wires tap across the plate rods about two inches from the shorting bar.

The plate circuit is tuned to the desired frequency by sliding the shorting-bar along the rods. Antenna coupling is adjusted by sliding the antenna taps along these rods until normal plate current is drawn. The inductance in the grid circuit can be varied by squeezing turns together and apart in order to obtain the best amount of feedback for high output with good stability.

1 1/4-Meter Transmitter with RCA 934

The Western Electric 304-B and RCA 834 are equally suitable for use in the transmitter shown in figures 28 and 29. The characteristics of both tubes are similar.

The circuit in figure 28 is suitable for oscillation between 1 and 3 meters, de-

pending upon the length of the parallel rods or pipes.

A slight variation of frequency is possible if two condenser plates each 3/4-in. square are connected across the pipes near the tube leads. This type of circuit works more efficiently than a conventional coil and condenser oscillator circuit. The tube leads fit into the ends of copper pipes, and small set screws provide good electrical contact between pipe and tube leads. This type of mounting must be used with care in order to avoid breakage of the tube envelope. The tube socket mounting strip should have slotted holes in order to make correct alignment with the copper pipes.

Filament r.f. chokes are necessary below 3 meters in order to secure oscillation. At 1 1/4 meters, the metal shell of the tube socket, and the metal support that holds the socket, introduce excessive capacity to the filament circuit of the tube, resulting in nonoscillation if either of these metal surfaces is grounded. A nonmetallic socket and socket support would be preferable if operation in the neighborhood of 1 meter is wanted. A tuned filament circuit, somewhat similar to the type used with filament tubes in a *tritnet*, will work

FIGURE 28. 834 U.H.F. TRANSMITTER.

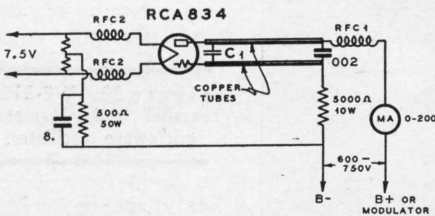

- C₁—Aluminum plates, 3/4-in. square
- Copper tubes—3 in. long for 1 1/4 meters
- Copper tubes—9 in. long for 2 1/2 meters

- RFC₁—40 turns no. 28 d.s.c., 1/4 - in. diam.
- RFC₂—25 turns no. 14 enam., 1/2-in. diam.

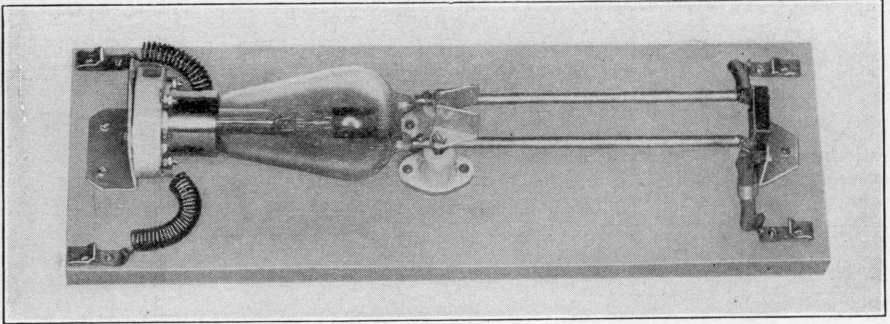

FIGURE 29. 2½-METER TRANSMITTER WITH RCA 834 U.H.F. TRIODE.

more effectively than r.f. chokes for wavelengths below 1½ meters.

The antenna feeder is coupled to the parallel pipes or tubes by means of a coupling loop. A half- or quarter-wave antenna can be capacitively coupled through a very small variable condenser to the plate rod at a point approximately one to two inches from the plate blocking condenser.

¾-Meter Parallel Rod WE-316A Transmitter

A large variety of circuits could be suggested for micro-wave operation, but the most simple of these is the one shown in figure 31. It consists of two parallel half-wave rods, spaced about ¼-inch apart, to provide a ¾-meter tuned circuit of fairly-high Q. The grid and plate of the tube are connected to the copper rods; this capacity causes

the physical length to be less than a half wavelength. As can be seen from the photograph, the plate r.f. choke and the grid leak do not connect to the center of the rods, but rather across the voltage node. The distance between this point and the free ends of the rods is a quarter wavelength. The other distance is shortened by the tube capacity.

Filament r.f. chokes, or tuned filament leads, are desirable for operation below one meter because the filament is not strictly at a point of ground potential in the oscillating circuit. These filament chokes consist of 30 turns of no. 16 enameled wire, wound on a ¼-inch rod, then removed from the rod and air-supported, as the picture shows. The length of these chokes is approximately 3 inches. A 200-ohm resistor is placed in series with the 110-volt a.c. line to the filament transformer in order to reduce the transformer secondary voltage from 2½ to 2 volts, because the filament of

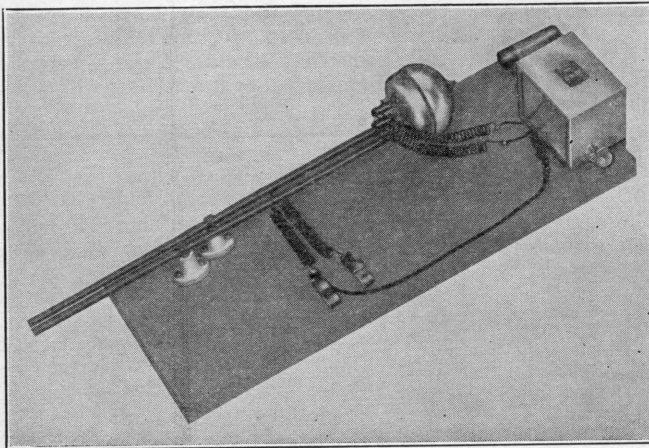

Figure 30. WE-316A parallel rod ¾-meter microwave oscillator.

the tube operates on 2 volts at 3.65 amperes. This particular oscillator gave outputs in excess of 5 watts on $\frac{3}{4}$ meter, even when no filament r.f. chokes were used.

This oscillator, when loaded by an antenna, draws from 70 to 80 milliamperes at 400 volts plate supply. The oscillator should be tested at reduced plate voltage, preferably by means of a 1000- to 2000-ohm resistor in series with the positive B lead, until oscillation has been checked. A flashlight globe and loop of wire can be coupled to the parallel rods at a point near the voltage node, in order to indicate oscillation. A thermo-galvanometer coupled to a loop of wire makes

a more sensitive indicator, but the high cost of this meter prohibits its use in most cases.

A 15-inch antenna rod or wire can be fed by a one- or two-wire feeder of the nonresonant type. A single-wire feeder can be capacitively coupled to the plate rod, either side of the voltage node, through a small blocking condenser. If a two-wire feeder is employed, a small coupling loop, placed parallel to the oscillator rods, with the closed end of the loop near the voltage node of the oscillator, will provide a satisfactory means of coupling to the antenna. The power output is high enough so that tuning is as simple as any 40-meter c.w. transmitter.

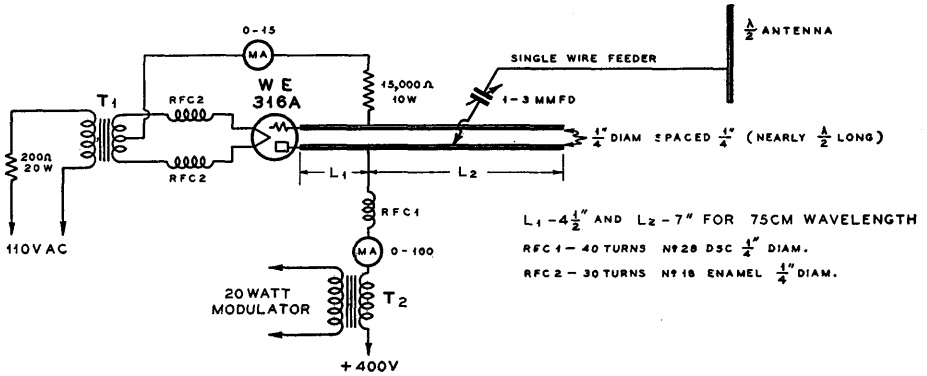

FIGURE 31. W.E.-316A $\frac{3}{4}$ -METER OSCILLATOR CIRCUIT.

PARALLEL ROD POWER AMPLIFIERS

Parallel rods can be used in place of the conventional solenoid and shunt condenser for plate tank circuits in u.h.f. power amplifiers. It is rather difficult to get a high-impedance, high-Q tank circuit at 56 Mc. and higher frequencies with the conventional coil and condenser tank. Linear (parallel rod) tank circuits are advantageous at these frequencies in power amplifiers not for reasons

of frequency stability but to provide a high-impedance, low-loss tank circuit.

The push-pull 5-meter amplifier of figure 32 is more efficient than a 5-meter amplifier using a conventional coil and tuning condenser for the plate tank. The circuit is resonated by adjusting the position of the shorting bar for minimum plate current.

LOW POWER-FACTOR LINE OSCILLATOR

A concentric-pipe oscillator suitable for the amateur 2.5-meter band can be made as shown in the illustrations, figures 33 and 34.

The grid of a 35-T tube is connected to the inner pipe at a point about 6 inches from the short-circuited end. The outer pipe is 30 inches long and is sol-

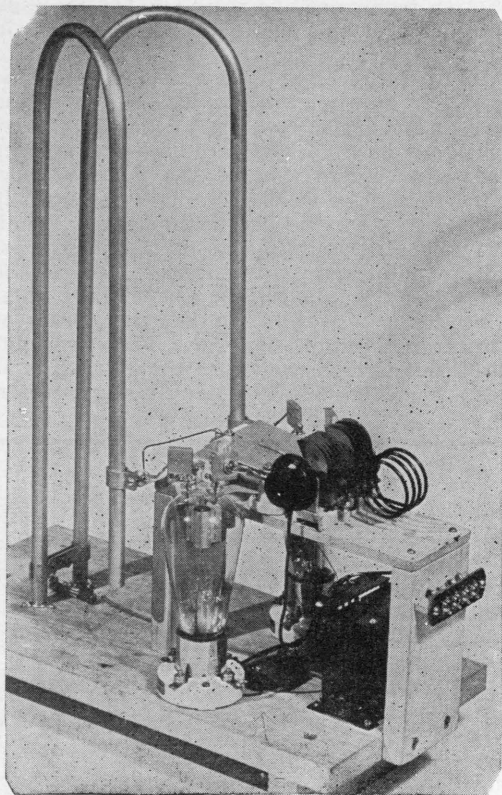

Figure 32. Highly efficient 5-meter push-pull amplifier stage utilizing a linear tank in the plate circuit instead of coil and condensers.

of the pipe extend into the larger pipe (for 2.5-meter operation). Waxed linen cords are wrapped around the inner pipe in order to center its position with respect to the outer pipe. The quarter-wave pipe tuned circuit controls the frequency of operation and results in a highly stable self-excited oscillator.

The entire transmitter should be suspended by a shock absorbing system in order to prevent vibration, which would impair the frequency stability. An efficiency of about 50 per cent can be obtained with this oscillator. At a plate potential of 500 volts, the plate current was 25 ma., at 700 volts 35 to 40 ma., and at 1,000 volts from 75 to 90 ma. under load, in laboratory tests.

This oscillator can be plate modulated, or it can be used as a driver for a class-C amplifier.

dered to a copper sheet through which the inner pipe slides; this inner pipe is 27 inches long and from 24 to 25 inches

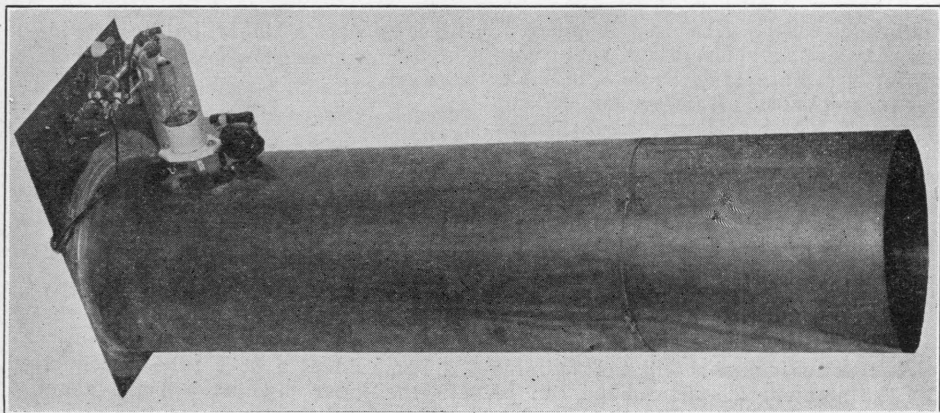

FIGURE 33. LOW POWER-FACTOR LINE OSCILLATOR USING CONCENTRIC PIPES.

C_1 —0.001- μ fd. mica
 C_2, C_3, C_4 —0.001- μ fd. mica
 C_5 —4- μ fd. double-spaced midget (neutralizing condenser)
 R —15,000 ohms, 10 watts

P_1 — 2"-dia. copper pipe 27" long slides inside P_2 through 2" hole in copper end plate
 P_2 —30" x 24" piece 16-oz. copper sheet formed into a pipe 30" long by 7 1/4" dia.

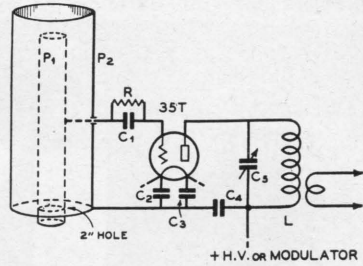

FIGURE 34. WIRING DIAGRAM FOR THE 2.5-METER 35-T CONCENTRIC PIPE LOW POWER-FACTOR LINE OSCILLATOR.

2 1/2-5-M. METAL TUBE TRANSCEIVER

Metal tubes fit readily into the design of a very compact and powerful transceiver for 5- and 2 1/2-meter operation. This unit here illustrated transmits more power than most transceivers because heavy antenna loading is permissible for both transmitting and receiving. It is quite sensitive and the hiss level is low. While radiated interference is much less than from most transceivers while receiving, due to the separate

interruption frequency coil circuit, it is recommended that in urban areas the transceiver be used only on 2 1/2 meters.

The r.f. chokes must be wound to the correct inductance so that no resonant absorption dips occur in either band. About 75 turns of no. 34 d.s.c. wire, closewound on a piece of 3/8-in. bakelite rod, serves the purpose. The terminals of these r.f. chokes are made by drilling small holes through the ends of the bakelite rod and then soldering the fine wire to a piece of no. 22 wire twisted through and around the ends of the rod.

The interruption frequency coil provides superregeneration in the 6C5 tube when receiving; thus heavy antenna loading and low plate voltage can be used on 5 meters. On 2 1/2 meters, the plate voltage should be 200 volts, preferably 250 if available. The transmitter output with 135 volts supply on 5 meters will be approximately 1/2 watt, and 1 1/4 watts at 200 volts, which is greater than the output obtainable from most other transceivers. A 6F6 power pentode acts as modulator when transmitting and as an audio amplifier when receiving. The output in the latter condition is sufficient to drive a small magnetic loudspeaker to moderate volume. The detector regeneration control can be set to a point of very low hiss level and high sensitivity.

A separate 4 1/2-volt microphone battery allows the use of either a.c. or d.c. supply for the heaters of the two tubes. Either an a.c. power supply or batteries can be used for home or portable opera-

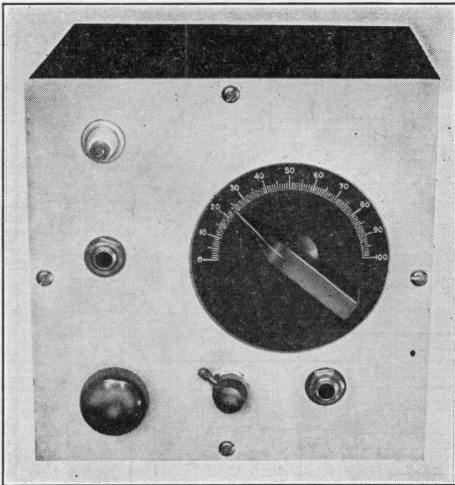

Figure 35. This 2.5- and 5-meter transceiver has more power than most similar transceivers. The whole unit is housed in a metal cabinet 6" square. It is especially recommended for 2.5-meter mobile operation.

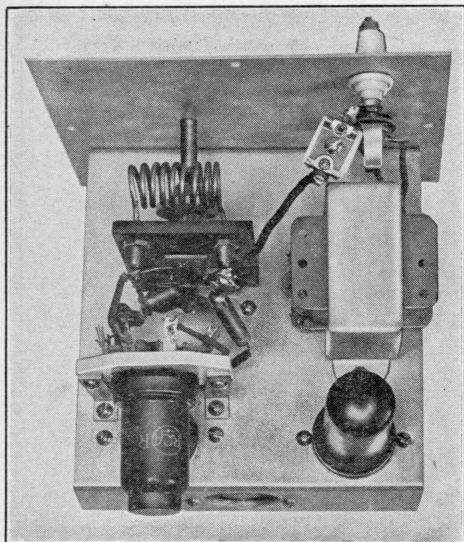

Figure 36. Inside view of the transceiver. Horizontal mounting of the oscillator tube permits very short r.f. leads. If the unit is to be used only on 2.5 meters, one turn may be added to the tuning coil and the coil soldered directly to the tuning condenser. This will result in increased 2.5-meter output.

or 2½-meter antenna. The coupling condenser can be adjusted through a hole in the front panel by means of a bakelite screw driver. The shield of the 6C5 tube should "float," i.e., it is not connected to ground as is the usual practice.

The 5-meter coil consists of 9 turns no. 14 wire, ½-in. diameter and 1½ in. long. The 2½-meter coil has 3 turns, ½-in. diameter, wound to a length of between 1 in. and 1½ in., depending upon the length of r.f. leads in the r.f. tuning assembly. Pin-jacks serve as terminal plug receptacles for the little plug-in coils. The send-receive switch in its center position opens the heater supply circuit, but does not disconnect the B battery; consequently, if dry cells are used, the regeneration control will absorb a small amount of current even when the set is turned off unless the B-plus lead is opened by means of a switch or else disconnected.

The 6C5G and 6F6G large glass tube equivalents of the little 6C5 and 6F6 metal tubes can be substituted without change in circuit constants. Operation on 2½ meters should be slightly more efficient when using the glass 6C5G tube. These glass tubes have octal bases, but they require more space.

The same arrangement of horizontal r.f. tube mounting, very close to the tuning condenser and coil, is recommended

tion. Variable antenna coupling capacity will permit the use of any type of 5-

FIGURE 37. METAL TUBE 2½-5 METER CIRCUIT DIAGRAM.

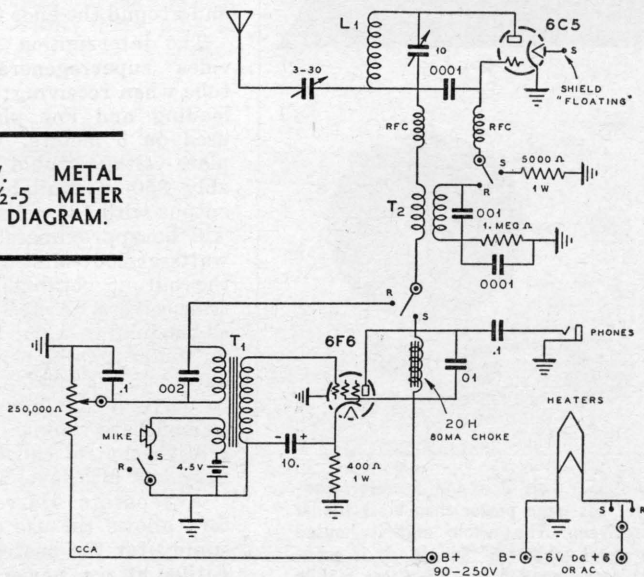

for a 6C5G if 2½-meter operation is desired. The tuning condenser has two plates. An insulated shaft connects the condenser rotor to the dial.

The three-winding midget audio transformer is manufactured by several con-

cerns. Any small 20-henry, 50-ma. filter choke is suitable for the modulation choke.

The performance of this unit is superior to most other transceivers and it is highly recommended for 2½-meter mobile work.

A 90-CM. TRANSCEIVER

A Self-Contained 90-Cm. Battery-Powered Transceiver

This unit was designed with one outstanding purpose in mind—to make as small as possible, and still to have it work. The cabinet measures 5½"x6"x5½". The circuit used is a form of the Lecher oscillator modified so that it can be worked as a self-quenching detector in receiving position. About the best way to place the parts in the box is shown in figure 39, although they could be arranged differently to suit one's own needs. Since most of the oscillator circuit is isolated by the radio-frequency chokes, it doesn't matter if the d.c. leads are a trifle long.

Looking down into the box, one should have little difficulty in discerning the various parts. Near the tuning condenser may be seen the r.f. chokes, wound on ¼-inch fibre shafting. They consist of 25 turns of no. 22 enameled wire (closewound). These chokes are extremely critical and may require alteration to be adapted for the specific transceiver.

The wires forming the Lecher system are directly underneath the tuning condenser and consist of two lengths of no. 12 bus wire, seven inches long, and bent into the shape of the letter "S," one end being soldered onto the acorn tube socket, while the other is soldered to the tuning condenser. They are spaced between ⅛- and ¼-inch apart and varied so that the transceivers may be lined up, both tuning to the same frequency at a given setting of capacity. The farther these two wires are separated, the lower the frequency at which they will oscillate.

The nut shown extending from the cabinet is fastened to the jack of the insulator when the cover is placed onto the cabinet. The antenna illustrated is a half-wave long, tapped onto the plate wire, close to the tuning condenser. One-half wave at this frequency is approxi-

mately eighteen inches. Care should be taken to see to it that the part of the

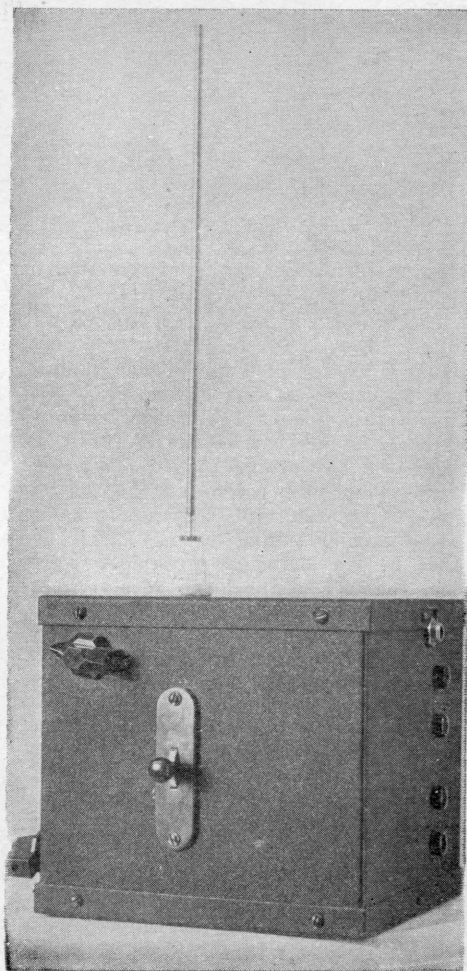

FIGURE 38. THIS BATTERY-POWERED 90-CM. TRANSCEIVER IS COMPLETELY SELF-CONTAINED.

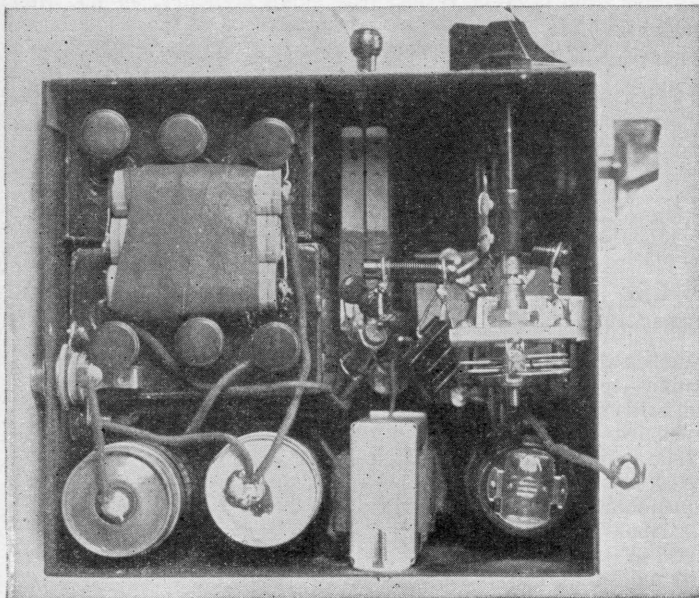

Figure 39. Looking down on the top of the unit. The two 45-volt plate batteries fit into the left section of the box with the 4½-volt modulator bias battery on top of them. The 6-volt flashlight-cell filament battery is behind them and the 4-p.d.t. transmit-receive switch is alongside.

antenna inside the cabinet is counted in making up the eighteen inches.

The tuning condenser used is a rebuilt midget 15- μ fd. Trim-air. The two stator plates were removed and sliced in half, then replaced on the condenser. With this arrangement, the rotor remains neutral and just varies the coupling between the two stator plates. With this arrangement, the rotor can only be varied 90 degrees, but it does add much to the vernier tuning action. Condenser C_2 is in the circuit to provide a short path for r.f. feedback, in receiving especially. For this reason, the leads to C_2 should be as short as possible. Without this condenser, very unstable regeneration will result.

Two Z30P B batteries comprise the plate supply. Long B-battery life is largely accounted for by the fact that the current consumption of the combined modulator and oscillator is only 6 ma. on transmitting and about 3 ma. on receiving.

The filament battery life is not quite so promising when using flashlight cells. For this reason, a jack arrangement is provided whereby a "Hot-Shot" battery, or four dry cells, may be plugged in for home use. In this way, the flashlight cells are saved and just used for real portability. The jack is so arranged that it cuts the flashlight cells out of the

circuit when the external battery is plugged in and then reconnects them when the plug is withdrawn. It may be seen on the right side of the cabinet. Since the 30 needs 4½-volts grid bias, when run at 90 volts plate, three pen-size flashlight cells are used for this purpose. These may be seen lying flush on top of the two B batteries.

Operation

In the receiving position, if working properly, the usual hiss found in all superregenerative receivers should be present. For best reception, the regeneration control should be turned back until just on the verge of the point of hiss. Here will be found a spot where the modulation will come through with comparatively little hiss. If the regeneration control is advanced further, signals may still be received, but the sensitivity drops off.

One will find that the outfit will more than likely transmit best on one frequency. This may be due to the antenna radiating best on this frequency, or because the oscillator works better here.

In actual operation, communication was maintained a distance of six miles. This was between two hills which were not high but were in an optical line. Signal strength was R7 over this distance.

FIGURE 40. GENERAL WIRING DIAGRAM OF THE 90-CM. TRANSCIVER.

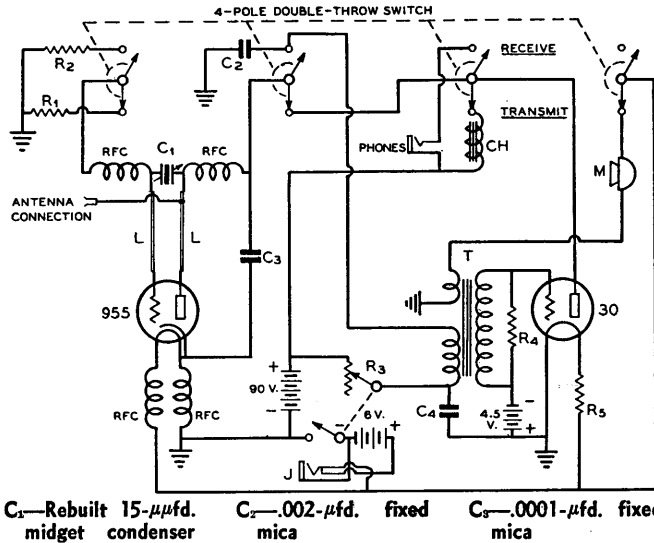

- C₁—25- μ fd. 400-volt tubular
- R₁—25,000 ohms, $\frac{1}{2}$ watt
- R₂—5 megohms, $\frac{1}{2}$ watt
- R₃—200,000-ohm potentiometer with switch
- R₄—500,000 ohms, $\frac{1}{2}$ watt
- R₅—50-ohms, 5-watt filament resistor
- CH—11-hy. midget choke, low current
- T—Midget mike and audio plate to grid
- RFC—25 t. no. 22 enam. on $\frac{1}{4}$ " fiber rod
- L—Lecher wire plate circuit (see text)
- J—Midget closed circuit jack

$\frac{3}{4}$ - METER RECEIVER

Lack of stability and difficulty of tuning a microwave receiver have been the two principal obstacles in the past. Stable operation can be obtained by confining the radio frequencies to certain portions of the circuit of a parallel-wire oscillator, as shown in figure 42.

In the receiver described here, the quarter-wave parallel-wire tuning section can be tuned over a range of nearly 10 centimeters by means of a relatively large series tuning condenser. This condenser, when set to maximum capacity, acts as a short-circuit across the parallel wires. Settings of lower capacity tend to decrease the effective length of the parallel wires by means of series tuning. This is more satisfactory than the use of parallel tuning across the grid and plate terminals of the type 955 acorn tube.

The acorn tube and tuning condenser are mounted on a small panel above the aluminum chassis. Small r.f. chokes are placed in series with the heater and ca-

thode leads of the 955 tube. These r.f. chokes consist of 25 turns of no. 24 d.c.c. wire, in the form of a self-supported winding, $\frac{1}{4}$ inch in diameter. The plate choke is similar in construction, and with the same number of turns as the other chokes.

A quarter-wave tuned circuit of two parallel wires, terminated with a small fixed mica condenser, can be used in place of the heater and cathode chokes for wavelengths of less than $\frac{3}{4}$ meter. One side of the heater connects to the cathode at the acorn tube socket. The plate and grid terminals to the 955 tube connect to two parallel wires, each approximately $1\frac{1}{2}$ -in. long for $\frac{3}{4}$ -meter operation. These two wires are soldered directly to the leads of the submidget 100- μ fd. tuning condenser, which is designed for u.h.f. operation.

The rotor of this condenser is connected through an insulated flexible coupling for front-panel dial tuning; a cable drive connects the tuning dial to

Figure 41. Practical microwave receiver with acorn triode detector and '76 audio stage. This design must be rigidly adhered to, and all specifications closely followed.

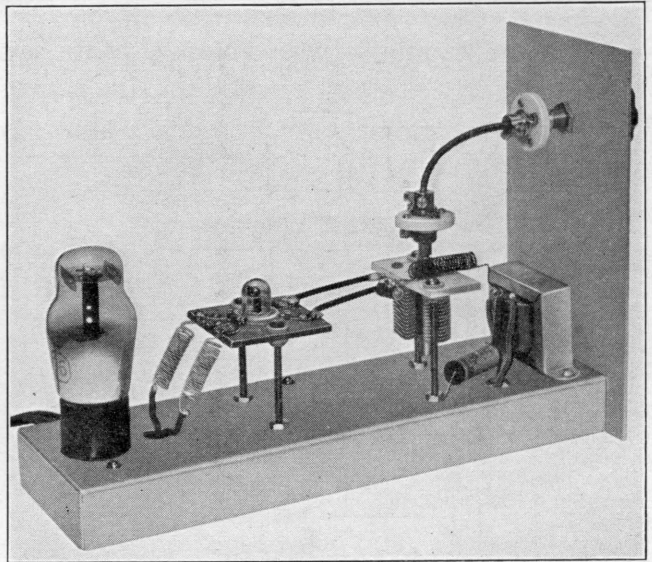

the condenser coupling. The tuning range is approximately 70 to 80 centimeters. Superregeneration can be obtained with a 90-volt plate supply over a range of approximately 75 to 80 centimeters. The higher plate potential of

135 volts will allow superregeneration at lower capacity settings of the series tuning condenser, and thus permit higher frequency operation.

Superregeneration is obtained by means of a blocking grid action, with a 1-megohm grid leak connected across the parallel wire circuit. The output of the detector can be amplified by means of an audio transformer coupled stage or by impedance coupling; the latter is used in the circuit shown.

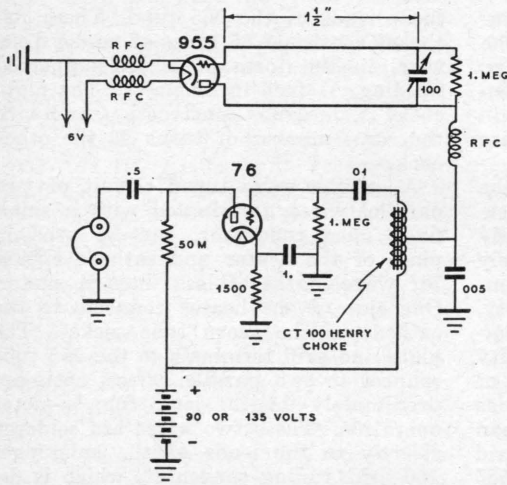

RFC — ALL 25 TURNS № 24 D.S.C. $\frac{1}{4}$ " IN DIAMETER

FIGURE 42. WIRING DIAGRAM OF THE MICRO-WAVE SUPERREGENERATIVE RECEIVER.

Chassis for Receiver

The chassis for this receiver is 3"x10"x1", and the front panel is 4"x8". The $\frac{3}{4}$ -meter tuned circuit is mounted high enough above the chassis so that there will be no effect from the metal chassis. Three resistors and the two larger fixed condensers are mounted under the chassis. A condenser and resistor in the plate circuit of the audio amplifier prevents d.c. from flowing through the headphones and allows grounding one side of the headphone jack. Either batteries or an a.c. power supply can be used to operate this receiver, provided that the plate potential is not more than 180 volts.

CHAPTER 17

Power Supplies

Construction of Modern Power Supply Units—Transformer and Filter Choke Design—A. C. and D. C. Tests and Measurements

ANY DEVICE which incorporates vacuum tubes requires a power supply for the filament and plate circuits of the tube or tubes. The filaments of the tubes must be heated in order to produce a source of electrons within the vacuum tubes; direct-current voltages are needed for the other electrodes in order to obtain detection, amplification, oscillation and rectification.

Either a.c. or d.c. voltage may be used for filament power supply in most applications; however, the a.c. power supply is the more economical and can be used with most tubes without introduction of hum in the output of the vacuum tube device. The plate potential must be secured from a d.c. source, such as from batteries or a rectified and filtered a.c. power supply.

The a.c. first must be converted into a unidirectional current; this is accomplished by means of vacuum tube *rectifiers*, of either the *full-* or *half-wave* type.

A half-wave rectifier passes one half of the wave of each alternation of the a.c. current and blocks the other half. The output current is of a *pulsating* nature, which can be smoothed into pure, direct current by means of *filter* circuits. Half-wave rectifiers produce a pulsating current which has zero output during one half of each a.c. cycle; this makes it difficult to filter the output properly into d.c. and also to secure good voltage regulation for varying loads.

A full-wave rectifier consists of two half-wave rectifiers working on opposite halves of the cycle, connected in such a manner that each half of the rectified a.c. wave is combined in the output as

shown in figure 1. This pulsating unidirectional current can be filtered to any desired degree, depending upon the particular application for which the power supply is designed.

A full-wave rectifier consists of two plates and a filament, either in a single glass or metal envelope for low-voltage rectification or in the form of two separate tubes, each having a single plate and filament for high-voltage rectification. The plates are connected across the high-voltage a.c. power transformer winding, as shown in figure 2. The power transformer is for the purpose of transforming the 110-volt a.c. line supply to the desired secondary a.c. voltages for filament and plate supplies. The transformer delivers alternating current to the two plates of the rectifier tube; one of these plates is positive at

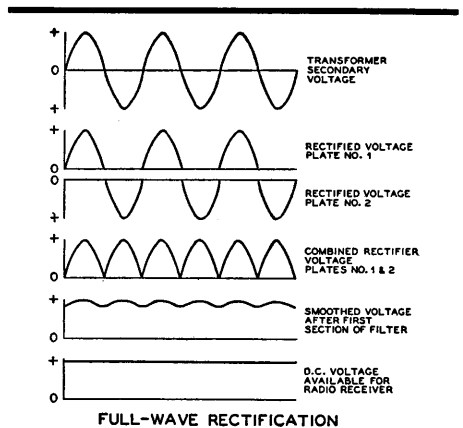

Figure 1. Showing effects of rectification and filtering of an alternating current.

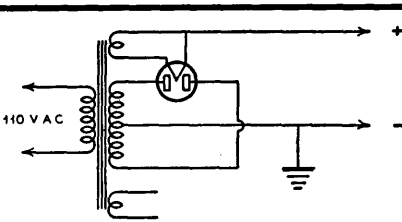

Figure 2. Full-wave single-phase rectifier circuit.

any instant during which the other is negative. The center point of the high-voltage transformer winding is usually grounded and is, therefore, at zero voltage, thereby constituting the *negative B connection*.

When one plate of the rectifier tube is conducting, the other is inoperative, and vice versa. The output voltages from the rectifier are connected together through a common rectifier filament cir-

cuit, and thus the plates alternately supply pulsating current to the output circuit. The rectifier tube filaments are always positive in polarity with respect to the output.

The output current pulsates 120 times per second for a full-wave rectifier connected to a 60-cycle a.c. line supply, and the output from the rectifier must connect to a *filter*, which will smooth the pulsations into direct current. Filters are designed to select or reject alternating currents; those most commonly used in a.c. power supplies are of the *low-pass* type. This means that pulsating currents which have a frequency below the cutoff frequency of the filter will pass through the filter to the load. Direct current can be considered as alternating current of zero frequency; this passes through the low-pass filter. The 120-cycle pulsations are similar to alternating current in characteristic, so that the filter must be designed to have a *cutoff* at a frequency *lower than 120 cycles*.

FILTER CIRCUITS

A low-pass filter consists of combinations of inductance and capacitance. An inductance or *choke coil* offers an impedance to any change in the current that flows through it. A high-inductance choke coil offers a relatively high resistance to the flow of pulsating current, with the result that the *a.c. component* or *ripple* passes from the rectifier tube through the load only with the greatest of difficulty. A capacitance has exactly the opposite action to that of an inductance. It offers a low impedance path to the flow of alternating or pulsating current, but presents practically infinite resistance to the flow of direct current. Inductance coils are usually connected in series with the rectifier outputs, while condensers are connected across the positive and negative leads of the output circuit. A simple filter circuit is shown in figure 3.

Electricity always follows the path of least resistance or impedance. The direct current will travel through the choke and back to the ground (negative B) connection through the *external load*, which normally consists of the plate

circuits of vacuum tubes. The a.c. component, or ripple, tends to be impeded by the choke and short-circuited by the condensers across the filter, which offer a lower reactance to the pulsating voltage than that offered by the load. The *load impedance* across the output of most filter systems is generally high, usually from 5,000 to 10,000 ohms. This load resistance can be calculated by dividing the output voltage by the total load current; this value is necessary in making calculations for low-pass resonant types of filter circuits.

A resonant type filter is shown in figure 4, in which the condenser C_1 tunes the choke coil inductance to series resonance at the ripple frequency. Series

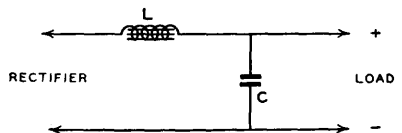

Figure 3. Simple, single-section choke-input filter.

resonance provides a very low impedance to the resonant frequency limited only by the actual resistance of the choke coil (since the reactance of both the condenser C_1 and the choke coil cancel each other).

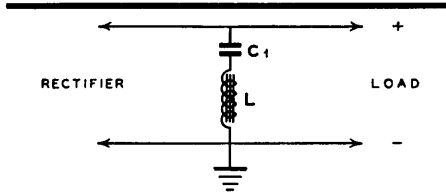

Figure 4. Series resonant filter circuit.

The filter circuit in figure 4 accomplishes the same purpose as a large shunt condenser at the ripple frequency, but is not effective in short-circuiting the higher harmonics in the output of the rectifier system. Additional low-pass filter circuits are needed to remove these harmonic components, which are of great enough magnitude to produce objectionable high-pitched hum in the vacuum tube amplifier circuits.

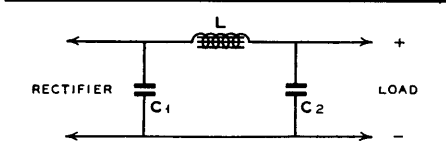

Figure 5. Single-section condenser input or π -type filter, also known as low-pass or "brute force" filter.

A typical low-pass filter is diagrammed in figure 5. The combination of C_1 , C_2 and L should give a cutoff frequency below that of the rectified output pulsation frequency.

This type of filter is very effective because the circuit can be designed with any cutoff frequency, as long as the attenuation or rejection at the 120-cycle-and-higher harmonic frequencies is great. This type of filter is sometimes called a "brute force" filter, because large values of inductance and capacitance are normally used without much attention being paid to the actual cutoff frequency. Inductance values of 10 to 30 henrys are used for filter chokes, and shunt capacities of from 2 to 16 microfarads are used for C_1 and C_2 in figure 5.

A resonant trap circuit, such as shown

in figure 6, is sometimes used to increase the impedance of the choke L at some particular frequency, such as 120 cycles per second.

Parallel resonance of C_2 and L provides a very high impedance at the resonant frequency. The condenser C_2 tends to by-pass the higher ripple harmonics that get through the trap circuit. This type of filter is often used in conjunction with an additional section of filter of the type shown in figure 3.

The single-section, low-pass filter in figure 5 is often combined with an additional choke coil as shown in figure 7. The additional choke coil L_1 is an aid in filtering and also provides better voltage regulation for varying d.c. loads, such as presented by a class-B audio amplifier.

A two-section, low-pass filter with condenser input is shown in figure 8. In some cases, additional sections of choke coils and condensers are added for the purpose of obtaining very pure direct current.

Resistors may be used in place of inductances in circuits where the load cur-

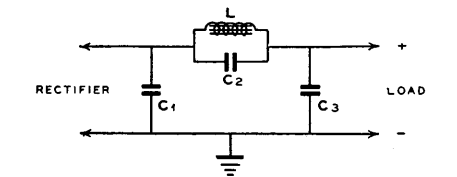

Figure 6. "Brute force" filter with choke resonated to ripple frequency to increase impedance.

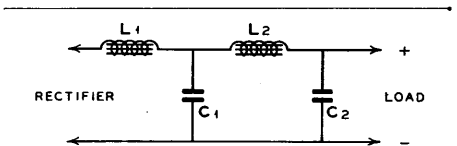

Figure 7. Adding an input choke to the "brute force" filter improves both regulation and filtering at a sacrifice in output voltage.

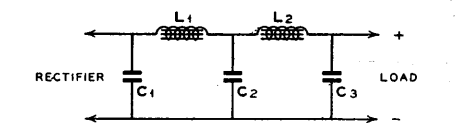

Figure 8. Two-section low-pass filter for use where very pure d.c. is required, as in low-level speech amplifiers.

rent is of low value, or where the applied d.c. voltage must be reduced to some desired value.

The ripple in the output of a filter circuit can be measured with an oscilloscope or by means of the simple circuit in figure 9. A high-voltage condenser C_3 , having a capacity of from $\frac{1}{4}$ to 1 μfd ,

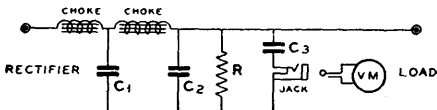

Figure 9. Circuit for measuring a.c. ripple.

and a high-resistance copper-oxide a.c. voltmeter provides a method of measuring the actual ripple voltage.

The voltmeter should be plugged into the measuring jack after the power supply and external load circuit are in normal operating condition, and the meter should be removed from the shorting type jack before turning off the power supply or removing the load. The charging current through condenser C_3 would tend to burn out the meter if it were left in the circuit at all times.

Filter Circuit Considerations

The shunt condensers in a filter system serve a dual purpose. They provide: (1) a low impedance path for ripple, (2) an energy-storing system for maintaining constant power output from the power supply. The condensers are charged when the peak voltage is applied across them from the output of the rectifier; during the time in which the rectifier output decreases to zero, the filter condensers supply output current to the load. This action provides a constant output voltage.

In an a.c. circuit, the maximum peak voltage or current is the square root of 2 or 1.41 times that indicated by the a.c. meters in the circuit. The meters read the root-mean-square (r.m.s.) values, which are the peak values divided by 1.41 for a sine wave.

If a potential of 1,000 r.m.s. volts is obtained from a high-voltage secondary winding of a transformer, there will be 1,410-volts peak potential from the rectifier plate to ground. The rectifier tube

has this voltage impressed on it, either positively when the current flows or "inverse" when the current is blocked on the other half-cycle. The inverse peak voltage which the tube will stand safely is used as a rating for rectifier tubes. At higher voltages the tube is liable to arc back, thereby destroying it. The relations between peak inverse voltage, total transformer voltage and filter output voltage depend upon the characteristics of the filter and rectifier circuits (whether full- or half-wave, bridge, etc.).

Rectifier tubes are also rated in terms of peak current load. The actual direct load current which can be drawn from a given rectifier tube or tubes depends

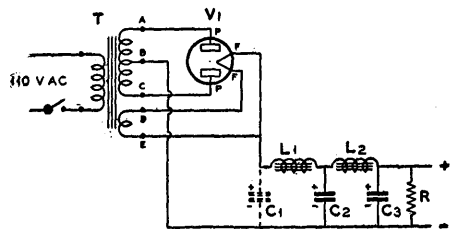

Figure 10. When C_1 is connected in the circuit, the filter is termed "condenser input." If C_1 is omitted, the filter is called "choke input."

upon the type of filter circuit. A full-wave rectifier with condenser input may be called upon to deliver a peak current several times the direct load current.

In a filter with choke input, the peak current is not much greater than the load current if the inductance of the choke is fairly high.

A full-wave rectifier with two rectifier elements requires a transformer which delivers twice as much a.c. voltage as would be the case with a half-wave rectifier or bridge rectifier. The bridge rectifier is another type of full-wave circuit in which four rectifier elements or tubes are operated from a single high-voltage winding on the power transformer.

While twice as much output voltage can be obtained from a bridge rectifier as from a center-tapped circuit, the permissible output current is only one half as great for a given power transformer. In the bridge circuit, four rectifier and three filament heating transformer

windings are needed, as against two rectifiers and one filament winding in the center-tapped full-wave circuit. In a bridge rectifier circuit, the inverse peak voltage impressed on any one rectifier tube is halved, which means that tubes of lower peak voltage rating can be used for a given voltage output.

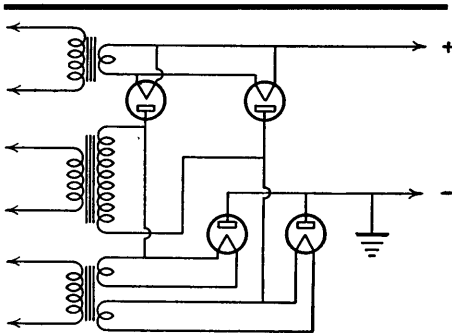

Figure 11. Bridge rectifier circuit.

The output voltage across the filter circuit depends upon the design of the filter, resistance of rectifier, power transformer and load resistance. A low-resistance rectifier, such as the mercury-vapor type 83 or 866, has very low voltage drop in comparison with most *high-vacuum* (not mercury-filled) rectifiers. The filter circuit with *condenser input*, i.e., a condenser across the rectifier output, will deliver a higher d.c. voltage than one with *choke input*, but with a sacrifice both in voltage regulation and the amount of available load current.

The d.c. voltage across the load circuit of a condenser-input filter may be as high as 1.4 times the a.c. input voltage (r.m.s.) across one of the rectifier tubes if the input condenser capacity is large and the current drain small. Low values of load resistance (heavy current drain) will cause this type of power supply to have a d.c. voltage output as low or even lower than the a.c. input to the rectifier. The maximum permissible load current in this same circuit is less for a given transformer-secondary wire size and rectifier tube peak current rating than would be the case for a choke-input filter.

A choke-input filter will reduce the d.c. voltage to a value of 0.9 the a.c. r.m.s. value, but the output voltage with

choke input is fairly constant over a wide range of load resistances, and the allowable load current is greater than with condenser input for a given rectifier tube and power transformer.

Types of Chokes

A *filter choke coil* consists of a coil of wire wound on a laminated iron or steel core. The size of wire is determined by the amount of direct current which is to flow through the choke coil. This direct current magnetizes the core and reduces the inductance of the choke coil; therefore, filter choke coils of the "smoothing" type are built with an air gap, a small fraction of an inch in the iron core, for the purpose of preventing saturation when maximum d.c. flows through the coil winding. This "air gap" is usually in the form of a piece of fiber inserted between the ends of the laminations. The air gap reduces the initial inductance of the choke coil, but keeps it at a higher value under maximum load conditions. The coil must have a great many more turns for the same initial inductance when an air gap is used.

As explained earlier in this chapter, choke input tends to keep the output voltage of the filter at approximately 0.9 of the r.m.s. voltage impressed upon the filter from the rectifiers. However, this effect does not take place until the load current exceeds a certain minimum value. In other words, as the load current is decreased, at a certain critical point the output voltage begins to soar. This point is determined by the inductance of the input choke. If it has high inductance, the current can be reduced to a very low value before the output voltage begins to soar. Under these conditions, a low-drain bleeder resistor will keep the current in excess of the critical point and the voltage will not soar even if the external load is removed. For this purpose, chokes are made with little or no air gap in order to give them more inductance at low values of current. Their filtering effectiveness at maximum current is impaired somewhat, but it permits use of a smaller bleeder to keep the current in excess of the critical value. Such chokes are called *swinging chokes* because, while they have high initial inductance, the inductance rapidly falls to a comparatively low value as the current through the choke is increased.

The d.c. resistance of any filter choke should be as low as possible in conjunction with the desired value of inductance. Small filter chokes, such as those used in radio receivers, usually have an inductance of from 20 to 30 henrys, and a d.c. resistance of from 200 to 400 ohms. A high d.c. resistance will reduce the output voltage, due to the voltage drop across each choke coil. Filter choke coils for radio transmitters and class-B amplifiers usually have less than 100-ohms d.c. resistance.

Types of Filter Condensers

There are two types of filter condensers: (1) paper dielectric type, (2) electrolytic type.

Paper condensers consist of two strips of metal foil separated by several layers of waxed paper. Some types of paper condensers are wax-impregnated; others, especially the high-voltage types, are oil-impregnated. High voltage filter condensers which are oil-impregnated will withstand a greater peak voltage than those impregnated with wax, but they are more expensive to manufacture. Condensers are rated both for *flash* test and normal operating voltages; the latter is the important rating and is the maximum voltage which the condenser should be required to withstand in service.

The condenser across the rectifier circuit in a condenser-input filter should have a working voltage rating equal to at least 1.41 times the r.m.s. voltage output of the rectifier. The remaining condensers may be rated more nearly in accordance with the d.c. voltage.

Electrolytic condensers are of two types: (1) wet, (2) dry. The wet electrolytic condenser consists of two aluminum electrodes immersed in a solution called an *electrolyte*. A very thin film of oxide is formed on the surface of the metal; this acts as the dielectric. The electrolytic condenser must be correctly connected in the circuit because it has positive and negative electrodes, and a reversal of the polarity will ruin the condenser. The dry type of electrolytic condenser uses aluminum electrodes with an electrolyte in the form of paste. The dielectric in both kinds of electrolytic condensers is not perfect; these condensers have a much higher direct current leakage than the paper type. The leak-

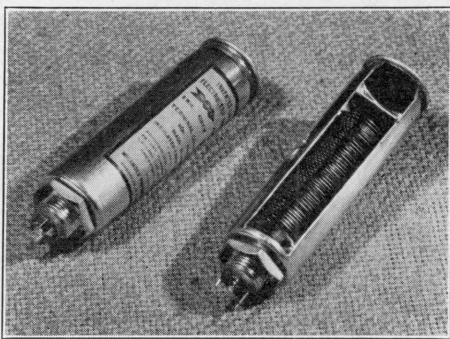

Figure 12. Newer form of electrolytic condenser with a bank of electrodes, rather than a foil-coated layer.

age current is greater in the wet electrolytic than in the dry types.

The high capacitance of electrolytic condensers results from the thinness of the film which is formed on the plates. The maximum voltage that can be safely impressed across the average electrolytic filter condenser is between 450 and 600 volts; the working voltage is usually rated at 450. When electrolytic condensers are used in filter circuits of high-voltage supplies, the condensers should be connected in series, as shown in figure 13. The positive terminal of one condenser must connect to the negative terminal of the other, in the same manner as dry batteries are connected in series. Grid leak resistors of equal value should be connected across each condenser in order to equalize the leakage and to provide a more uniform d.c. voltage drop across each condenser section.

The capacity of two condensers in series is only one half that of a single con-

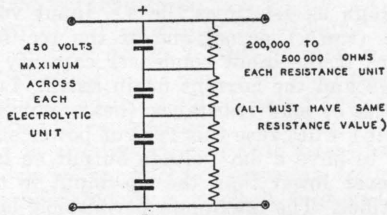

Figure 13. Electrolytic condensers connected in series plus to minus, with 500,000-ohm, 1-watt, resistor connected across each condenser in order to equalize the leakage. The resistors are not required if the electrolytic condensers are all of the same make, type and capacity.

OUTPUT VOLTAGE	RESISTANCE IN OHMS	ACTUAL DISSIPATED POWER IN WATTS	RECOMMENDED RESISTOR WATTAGE RATING
500	25,000	10	25
1,000	50,000	20	50
1,500	75,000	25	50
2,000	100,000	40	100
2,500	150,000	42	100
3,000	200,000	45	100

denser, but the voltage breakdown rating is doubled. Four condensers in series give only one fourth as much capacity as a single condenser, but the voltage breakdown rating is approximately four times as high. There is very little economy in using electrolytic condensers in series in circuits where more than two of these condensers would be required to prevent voltage breakdown.

Bleeder Resistors

A heavy-duty resistor should be connected across the output of a filter in order to draw some load current at all times. This resistor avoids soaring at no load when swinging choke input is

used and also provides a means for discharging the filter condensers when no external vacuum-tube circuit load is connected to the filter. This *bleeder* resistor should normally draw approximately 10 per cent of the full load current. The power dissipated in the bleeder resistor can be calculated by dividing the square of the d.c. voltage by the resistance. This power is dissipated in the form of heat, and, if the resistor is not in a well-ventilated position, the wattage rating should be higher than the actual wattage being dissipated. The above table gives suitable values of bleeder resistors for power supply systems with from 500 to 3,000 volts output.

RECTIFIER CIRCUIT

The three types of rectifier circuits for single-phase a.c. line supply consist of a half-wave rectifier, as shown in figure 14, a full-wave rectifier as shown in figure 15 and a bridge rectifier circuit as shown in figure 16.

Three-phase circuits can be connected for half-wave rectification, as shown in figure 17, or for full-wave rectification as shown in figure 18.

The most popular circuits are those shown in figures 15 and 16. The maxi-

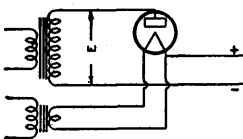

SINGLE PHASE HALF WAVE

FIGURE 14.

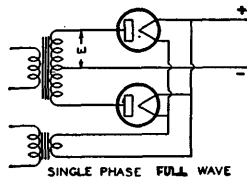

SINGLE PHASE FULL WAVE

FIGURE 15.

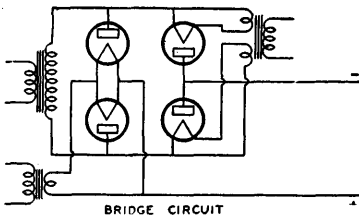

BRIDGE CIRCUIT

FIGURE 16.

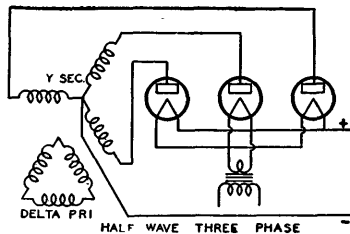

DELTA PRI HALF WAVE THREE PHASE

FIGURE 17.

FIGURE NO.	TRANSFORMER VOLTS MAX. "E"	D.C. OUTPUT VOLTS AT INPUT TO FILTER	D.C. OUTPUT CURRENT IN AMPERES
18	.35 x Inv. Pk. Vtg.	.9 x E	.66 x Pk. Plate
19	.7 x Inv. Pk. Vtg.	.9 x E	.66 x Pk. Plate
20	.43 x Inv. Pk. Vtg.	1.12 x E	.83 x Pk. Plate
21	.43 x Inv. Pk. Vtg.	2.25 x E	1.0 x Pk. Plate

imum transformer voltage of the high-voltage secondary, d.c. output voltage for choke-input filter, and maximum direct load current are shown in the accompanying table in terms of rectifier tube peak ratings. These peak ratings are listed in a separate table for a few commonly used rectifier tubes.

An example for applying the figures in the table, if type 866 A rectifier tubes are used as in figure 15, is given here: The maximum transformer voltage E across each side of the center tap is 0.35 times 10,000 or 3,500 volts. The d.c. voltage at the input to the filter (choke input) is 3,500 times 0.9 or 3,150 volts. The maximum advisable d.c. output current is 0.66 times the peak plate current of 0.6 ampere or 396 milliamperes.

These are the maximum voltages and currents which can be used without exceeding the ratings of the rectifier tubes. The actual d.c. voltage at the output of the filter will depend upon the d.c. resistance of the filter, and can be found by subtracting the IR drop across the filter chokes from the value of 0.9 times the transformer voltage E. This does not take into consideration the voltage drop in the power transformer and rectifier tubes. The voltage drop across a mercury vapor rectifier tube is always between 10 and 15 volts. However, the

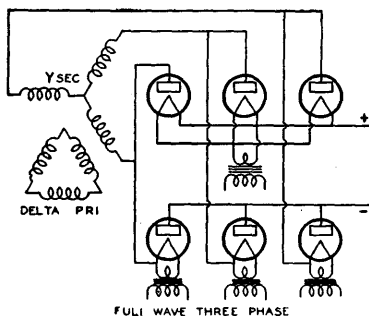

FIGURE 18.

TUBE TYPE	PEAK INV. VOLTS	PEAK PLATE CURRENT (AMP.)
66 Jr.	2,500	.25
82	1,400	.40
83	1,400	.80
66	7,500	.6
66A	10,000	.6
66B	8,500	1
72	7,500	2.5
72A	10,000	2.5
869	20,000	5.0
KY-21	11,000	3.0
KY-21	11,000	grid controlled

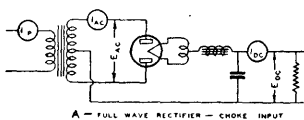

FIGURE 19.

E_{DC} -435 v.
 I_{DC} -100 ma.
 E_{AC} -1100 v.
 I_{AC} -71 ma.
 I_{PRI} -6 a.

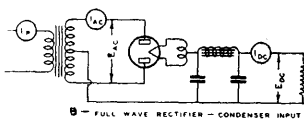

FIGURE 20.

E_{DC} -675 v.
 I_{DC} -100 ma.
 E_{AC} -1100 v.
 I_{AC} -103 ma.
 I_{PRI} -9 a.

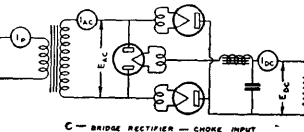

FIGURE 21.

E_{DC} -860 v.
 I_{DC} -100 ma.
 E_{AC} -1100 v.
 I_{AC} -96 ma.
 I_{PRI} -1.1 a.

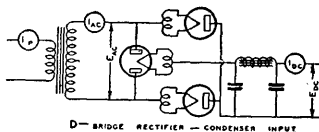

FIGURE 22.

E_{DC} -1200 v.
 I_{DC} -100 ma.
 E_{AC} -1100 v.
 I_{AC} -148 ma.
 I_{PRI} -1.65 a.

Typical voltage and current readings in various types of power supplies.

voltage drop across high-vacuum rectifier tubes can be many times greater.

The power supply circuits illustrated in figures 19 to 22 represent commonly-used connections for power transformers. The values of d.c. output voltage are indicated in each case for a load current of 100 ma. The transformer secondary potential is 1,100 volts. The interesting figures in connection with each circuit are those of the primary winding current.

The circuit in figure 22 should never be used unless the load current is very low. Manufacturers generally rate their transformers in terms of secondary r.m.s. voltage and the maximum d.c. load current which can be taken from a choke input filter circuit such as shown in figure 19. In order to prevent overload of the power transformer, the load current must be reduced to less than one third of the value which can be drawn from the circuit in figure 19. The load which can be drawn from the circuit in figure 21 without overload to the power transformer is approximately 50 per cent of that for the circuit in figure 19. The permissible direct load current in figure 20 would only be two-thirds as much as for figure 19, for a given transformer size.

Mercury Vapor Rectifier Tubes

When new or long-unused high-voltage

mercury-vapor rectifier tubes are first placed in service, the filaments should be operated at normal temperature for approximately 20 minutes before plate voltage is applied, in order to remove all traces of mercury from the cathode. After this preliminary operation, plate voltage can be applied within 20 to 30 seconds of the time the filaments are turned on each time the power supply is again used. If plate voltage is applied before the filament is brought to full temperature, active material may be knocked off the oxide-coated filament and the life of the tube will be greatly shortened.

Small r.f. chokes must sometimes be connected in series with the plate leads of mercury vapor rectifier tubes in order to prevent the generation of radio-frequency hash. These r.f. chokes must have sufficiently heavy wire to carry the load current and enough inductance to attenuate the r.f. parasitic noise current from flowing into the filter supply leads and thereby radiating into nearby radio receivers.

Small resistors or small iron-core choke coils should be connected in series with each plate lead of a mercury-vapor rectifier tube when used in circuits such as those shown in figures 23 and 24.

These resistors tend to prevent one plate from carrying the major portion of the current. *High-vacuum* type rectifiers which are connected in parallel do not require these resistors or chokes.

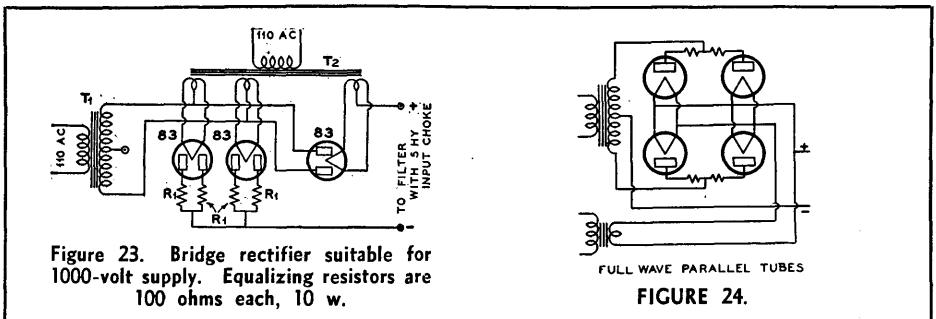

Figure 23. Bridge rectifier suitable for 1000-volt supply. Equalizing resistors are 100 ohms each, 10 w.

FIGURE 24.

BIAS VOLTAGE POWER SUPPLIES

Power supplies to supply negative grid voltage for radio or audio amplifiers differ from plate supplies only in that the positive and negative connec-

tions are reversed; the positive terminal of a C-bias supply is connected to ground. The filter chokes are usually connected in series with the hot (un-

grounded) lead, which in this case is the *negative* lead. A simple C-bias power supply for negative grid bias for a class-A audio amplifier is shown in figure 25.

The value of C bias depends upon the secondary voltage of the transformer and whether condenser or choke input to the filter is used.

The bias voltage supply for a linear r.f. amplifier or class-B audio amplifier must have a very low resistance bleeder; a circuit such as the one in figure 27 is satisfactory. The power transformer must be rated to carry a d.c. load current of approximately 250 ma., which is dissipated in the low-resistance bleeder.

The exact required voltage for a class-B audio amplifier can be obtained by means of a slider on the bleeder resistor, provided the latter has a very low resistance such as 800 to 2,000 ohms. The transformer secondary voltage should preferably be chosen in such a manner that the correct bias voltage is obtained at the output terminals of the filter.

A bias power supply for providing "protective bias" to the r.f. stages of a medium-power radio transmitter is shown in figure 26.

Two bleeder resistors with slider adjustments provide any desired value of

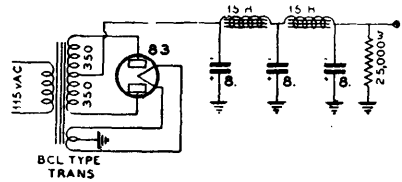
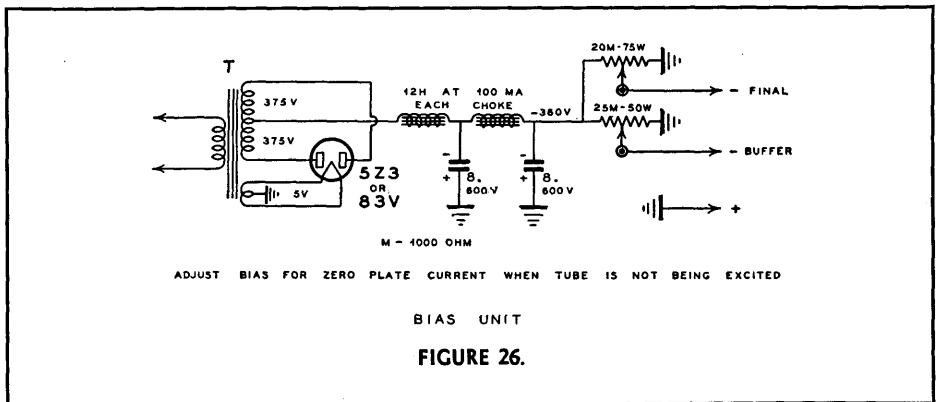

Figure 25. Here is a bias pack which uses a medium-to-high-resistance bleeder. Voltage regulation is usually unimportant in biasing a class-A modulator and very little bleeder is used.

negative grid bias for the r.f. amplifiers. The location of the slider on the resistors should be determined experimentally with the amplifier in operation, since the direct grid current of the r.f. amplifier itself will affect the voltage across the bias supply taps. If the final r.f. amplifier or buffer-amplifier operates with high- μ tubes, the values of bleeder resistance shown in figure 26 may have to be reduced as much as 50 per cent. The total resistance in series with the grid to ground acts as a grid leak resistance. The circuit illustrated is practically free from reaction between buffer and final amplifier bias.



TRANSMITTER POWER INPUT CONTROL

In the interests of interference reduction, one should run only sufficient power input to a radio transmitter to maintain satisfactory communication. The power input to the final r.f. amplifier of

a c.w. transmitter can be controlled over a very wide range by means of an *auto-transformer*, connected as shown in figure 30.

The a.c. voltage can be varied from a

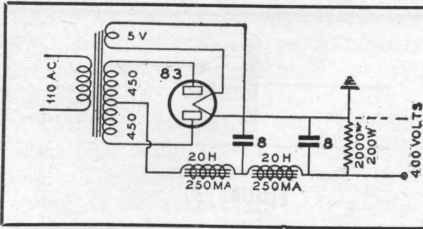

Figure 27. In the 350-volt bias pack shown here, a low-resistance bleeder is used to provide a constant voltage output. A bias pack of this type is suitable for class-B audio or class-BC linear amplifier operation. The ungrounded side is the negative terminal. The transformer should be rated at 200 ma.

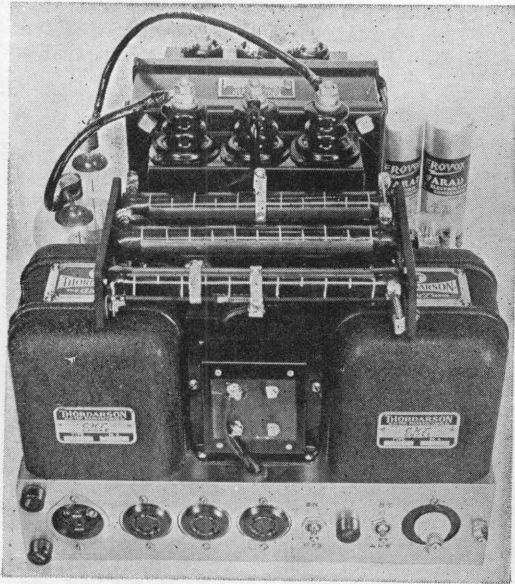
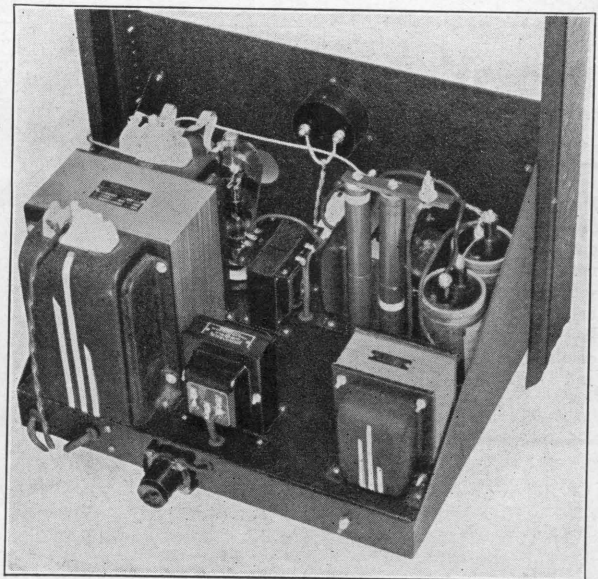

Figure 28. This dual power supply illustrates what can be crowded on a chassis when space is at a premium. Note how the heavy bleeders, which also act as voltage dividers, are mounted so as to provide free circulation of air. A pair of 866's serve as rectifier in a conventional circuit for the high-voltage supply; an 83 rectifier is used in the low-voltage supply.

Figure 29. A neat, well-constructed high-voltage supply delivering 1750 volts of well-filtered current, suitable for a medium-power phone transmitter.



few volts up to 130 volts, by means of a relatively small autotransformer. This a.c. voltage should be applied only to the high-voltage power transformer which supplies plate power to the final r.f. amplifier.

Convenient adjustment of input to a phone transmitter other than of the plate modulated type is a more difficult problem. Input to a plate-modulated transmitter can be varied the same as for a c.w. transmitter without danger of overmodulating the reduced input if the

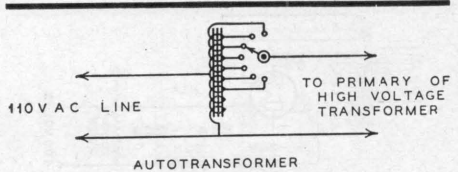

FIGURE 30.

primary voltage for the plate transformer that feeds the modulators is fed from the same tap on the autotrans-

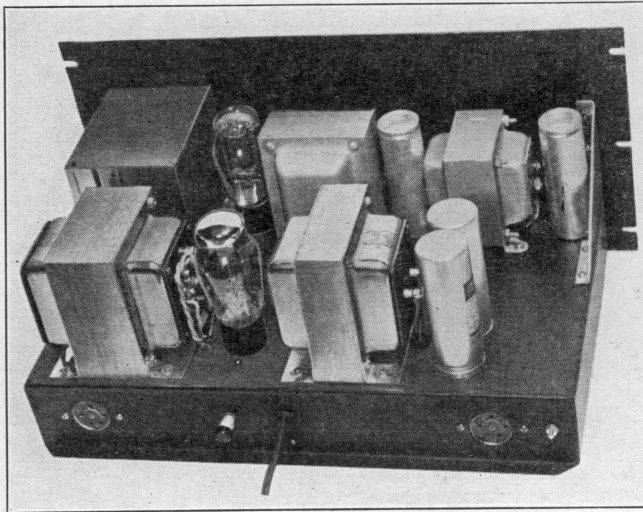
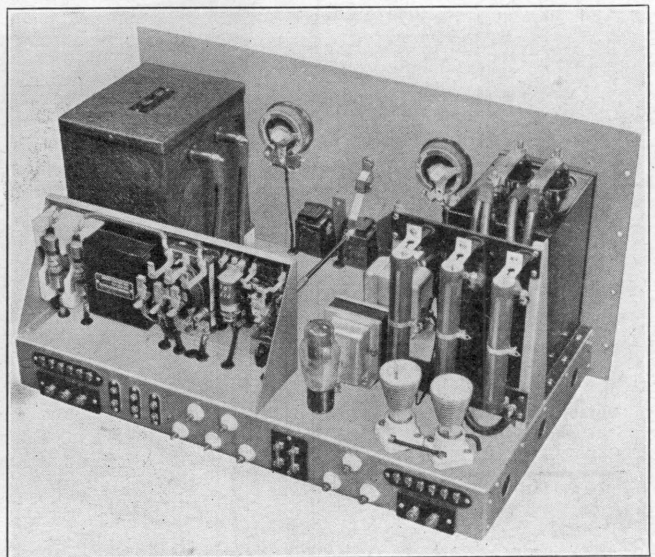

Figure 31. A dual power supply designed for supplying r.f. exciter and speech amplifier and driver stages. The smaller supply delivers 350 volts and is very well-filtered. The larger supply delivers 600 volts and is moderately well-filtered.

Figure 32. Relays for push-to-talk or break-in c.w. operation can be mounted on the power supply chassis, the logical place for them, as illustrated here in this combined high-voltage and low-voltage power supply.



former as the plate transformer for the final amplifier. If one power supply is used for both, the problem is further simplified.

Reducing the power of a grid-modulated final amplifier is more of a problem. The best method for reducing power is to reduce the r.f. excitation and audio gain together, without dis-

turbing the bias or plate voltage or antenna coupling adjustment.

Those using linear r.f. amplifiers can either incorporate a switching arrangement for throwing the antenna over to the low-level modulated stage and thus reduce power about 10 db, or else merely reduce excitation to the linear amplifier *without* disturbing the a.f. gain control.

Figure 33. In a rack-mounted power supply, which is supported from the front panel, it is advisable to place the heavy components close to the front panel to minimize the strain on the panel and chassis. Note the position of the heavy plate transformer in this 1800-volt 300-ma. supply designed to feed a plate-modulated class-C stage.

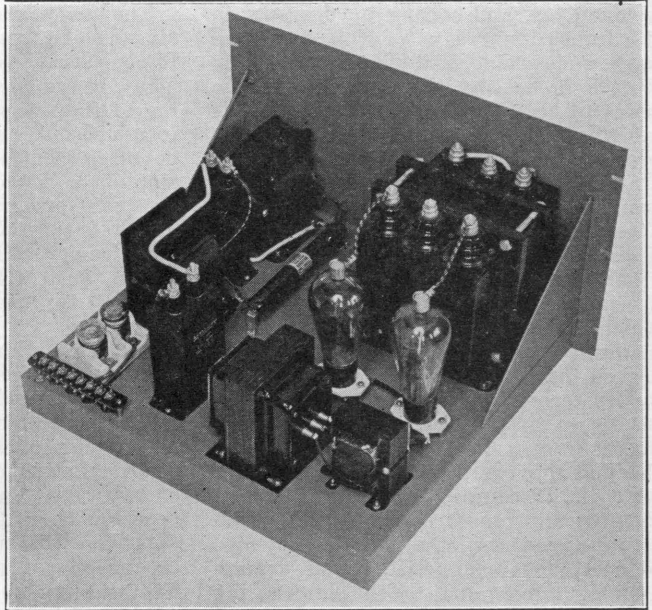

TRANSFORMER DESIGN

A common problem in radio and allied work is to determine how a transformer can be built to supply certain power requirements for a particular application, or how to calculate the windings needed to fit a certain transformer core which is already on hand. These problems can be solved by a small amount of calculation.

The most important factor in determining the size of any transformer is the amount of core material available. The electrical rating, as well as the physical size, is determined almost entirely by the size of the core. The core material is also important. The present practice is to use high-grade silicon-steel sheet. It will be assumed that this type

of material is to be employed in all construction herein described. Soft sheet-iron or stovepipe iron is sometimes substituted, but transformers made from such materials will have about 50 to 60 per cent of the power rating, pound for pound of core, as those made from silicon-steel.

The core size determines the performance of a transformer because the entire energy circulating in the transformer (except small amounts of energy dissipated in resistance losses in the primary) must be transformed from electrical energy in the primary winding to magnetic energy in the core, and reconverted into electrical energy in the secondary. The amount of core material

determines quite definitely the power that any transformer will handle.

Transformer cores are often designed so that if the losses per cubic inch of core material are determined, these losses can be used as a basis for calculating the rating of the transformer. These losses exist in watts, and are divided between the eddy current loss and the hysteresis loss. The eddy current loss is the loss due to the lines of force moving across the core, just as if it were a conductor, and setting up currents in it. Induced currents of this type are very undesirable and they are merely wasted in heating the core, which then tends to heat the windings, increase the resistance of the coils and reduce the overall power handling ability of the transformer. To reduce such losses, transformer cores are made of thin sheets, usually about no. 29 gauge. These sheets are insulated from each other by a coat of thin varnish, shellac or japan, or by the iron-oxide scale which forms on the sheets during the manufacturing process and which forms a good insulator between sheets.

"Hysteresis" means "to lag," and hysteresis in an iron-core means that the magnetic flux in the core lags behind the magnetizing force that produces it, which is, of course, the primary supply. Because all transformers operate on alternating current, the core is subjected to continuous magnetizing and demagnetizing force, due to the alternating effect of the a.c. field. This force heats the iron, due to molecular friction caused by the iron molecules re-orienting themselves as the direction of the magnetizing flux changes.

The higher the field strength, the greater the heat produced. A condition can be reached where a further increase in magnetizing flux does not produce a corresponding increase in the flux density. This is called "saturation" and is a condition which would cause considerable heat in a core. In practice, it has been found that all core material must be operated with the magnetic flux well below the limit of saturation.

Core losses manifest themselves as heat and these losses are the determining factor in transformer rating. They are spoken of as "total core loss," generally used as a single figure, and for common use a core loss of from .75 watt to 2.5 watts per pound of core material can be

assumed for 60 cycles. The lower figure is for the better grades of thin sheet, while the higher loss is for heavier grades.

About 1 watt per pound is a very satisfactory rating for common grades of material. This rating is also dependent on the manner in which the transformer is built and mounted and in the ease with which the heat is radiated from the core. Transformers with higher losses may be used for intermittent service.

The transformer core loss can be assumed to be from 5 to 10 per cent of the total rating for small transformers. Thus, if the core loss is known, the rating of the transformer can be easily determined. If the figure of 1 watt per pound is assumed, the problem is further simplified. To determine the rating of the transformer, weigh the core. If, for example, the core weighs 10 pounds, the transformer will handle from 100 to 200 watts. Such a transformer core can be assumed to have about 150 watts nominal rating.

If the weighing of the core is inconvenient, the weight can be calculated from the cubic content or volume. Sheet-steel core laminations weigh approximately one-fourth pound per cubic inch.

Transformer cores are generally made of two types, shell and core. The shell-type has a center leg which accommodates the windings, and this is twice the cross-sectional areas of the side legs. The core-type is made from strips built-up into a hollow-like affair of uniform cross section. For the shell-type core, the area is taken as the square section of the center leg, in this case $2\frac{1}{4} \times 4\frac{1}{2}$ " and in the core-type, this area is taken as the section of 1 leg, and is also $2\frac{1}{4} \times 4\frac{1}{2}$ ", or an actual core area in both cases of 10.1 square inches, which is large enough for a comparatively large transformer.

To determine the number of turns for a given voltage, apply the following formula:

$$E = \frac{4.44 N B A T}{10^8}$$

Where E equals the volts of the circuit; N, the cycles of the circuit; B, the number of magnetic lines per square inch of the magnetic circuit; A, the number of square inches of the magnetic circuit, and T, the number of turns.

The proper value for B, for small transformers and for ordinary grades of sheet-iron, such as are now being considered, is 75,000 for 25 cycles and 50,000 for 50 or 60 cycles.

Rewriting the above formula:

$$T = \frac{E \times 10^8}{4.44 N B A}$$

and since N and B are known

$$T = \frac{E}{4.44 \times 60 \times 50,000} \times \frac{10^8}{A}$$

from which

$$T = 7.5 \times \frac{E}{A}$$

That is, for a transformer to be used on a 60-cycle circuit, the proper number of turns for the primary coil is obtained by multiplying the line voltage by 7.5 and dividing this product by the number of square inches cross section of the magnetic circuit.

On a 25-cycle circuit, the 7.5 becomes 12, and on 50 cycles it becomes 9.

Tentative Design

Assume a transformer core that is to be used on a 115-volt, 60-cycle circuit for supplying power to two rectifier tubes, each of which takes 1,000 volts on the plate. The rectifier is of the full-wave type. The core measures 2½ inches x 4½ inches; hence,

$$T = \frac{7.5 \times 115}{2.25 \times 4.5} = 85 \text{ (to the nearest turn), and the volts per turn equals}$$

$\frac{115}{85} = 1.353$ which is the same for all coils.

Now, the secondary coil must have two windings in series, each to give 1,000 volts, and with a middle tap. The secondary turns will be

$$\frac{1,000}{1.353} = 1478 \text{ with a tap taken out at the 739th turn.}$$

Allowing 1,500 circular mils per ampere, the primary wire should be no. 12. The size of the wire on the plate coils may be no. 22 or 24 for a 400 to 300 ma. rating.

To determine the quantity of iron to

pile up for a core, it is well to consider 1 to 1.5 volts per turn as a conservative range. For trial, assume 1.25 volts. Then by transforming the first equation:

$$A = 7.5 \times \frac{E}{T} \text{ or, the area required}$$

is 7.5 times the volts per turn; in this case, $7.5 \times 1.25 = 938$ sq. in.

The magnetic cross section must be measured at right angles to the laminations that are enclosed by the coil, the center leg when the core is built up around the coil and either leg where the core is built up inside the coil, that is, between the arrows in the sketches shown below.

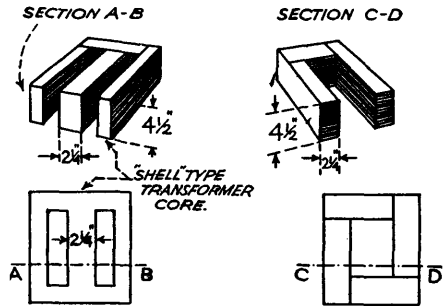

Figure 34. Types of transformer cores.

It should be kept in mind that there is a copper or resistance loss in all transformers. This is caused by the passage of the current through the windings and is commonly spoken of as the "IR" loss. It manifests itself directly as heat and varies as the load is varied; the heavier the load, the more heat is developed.

This heat, as well as other heat losses, must be removed or the transformer will burn up. Most transformers are so arranged that both the core and windings can radiate heat into the surrounding air and thus cool themselves. Large transformers are mounted in oil for cooling and also for the purpose of increasing the insulation factor.

In any transformer, the voltage ratio is directly proportional to the turns ratio. This means that if the transformer is to have 110-volts input and 250 turns for the primary, and if the output is to be 1,100 volts, 2,500 turns

SECONDARY WINDINGS (Turns for Voltages Given)

HIGH-VOLTAGE WINDING

WATTS	Section of Core (inches)	Area of Core (Square inches)	Primary Turns	Primary Wire Size	Turns per Volt	2.5 volts	5.0 volts	6.3 volts	7.5 volts	10 volts	250 volts	300 volts	350 volts	400 volts	450 volts	500 volts	600 volts	700 volts	800 volts	900 volts	1000 volts	1250 volts	1500 volts	
						250 volts	300 volts	350 volts	400 volts	450 volts	500 volts	600 volts	700 volts	800 volts	900 volts	1000 volts	1250 volts	1500 volts						
10	1/2 x 1/2	.25	3500	31	32	80	160	205	240	320														
10	1/2 x 5/8	.31	2800	31	24.2	61	122	147	182	242														
12	1/2 x 3/4	.37	2300	30	20.0	50	100	126	150	200														
12	5/8 x 5/8	.38	2280	30	19.6	48	96	124	147	196														
15	5/8 x 3/4	.46	1875	29	16.1	42	84	105	124	161														
22	5/8 x 1	.62	1400	28	12.2	31	61	77	92	122														
20	3/4 x 3/4	.55	1570	28	13.6	34	68	86	102	136														
25	3/4 x 1	.75	1150	27	10.9	25	50	63	75	100	2620	3150	3700	4200	4750	5250								
30	3/4 x 1 1/4	.93	930	26	8.1	21	42	52	62	81	2100	1500	3140	3400	3800	4200								
50	5/8 x 1 1/2	1.12	770	24	6.7	17	34	43	50	67	1860	2100	2500	2840	3150	3500	4200	5000						
50	1 x 1	1.0	860	24	7.5	19	38	48	57	75	1950	2400	2700	3150	3600	3900	4700	5500						
60	1 x 1 1/4	1.25	690	23	6.0	15	30	38	45	60	1600	1900	2200	2500	2800	3150	3800	4400						
65	1 x 1 1/2	1.50	575	23	5.0	13	25	32	38	50	1300	1575	1850	2100	2400	2650	3150	3700						
75	1 x 1 3/4	1.75	490	22	4.2	11	21	27	31	42	1100	1320	1550	1750	2000	2200	2650	3150	3800	4000	4400			
110	1 x 2	2.0	430	21	3.7	9	18	23	28	37	980	1170	1370	1650	1750	1960	2300	2750	3100	3500	3900			
105	1 1/4 x 1 1/4	1.56	550	21	4.8	12	24	31	36	48	1260	1510	1770	2050	2240	2510	3050	3500	4100	4500	5020			
100	1 1/4 x 1 1/2	1.87	460	21	3.8	9	19	25	29	38	1000	1200	1400	1600	1800	2000	2400	2720	3200	3560	4000			
120	1 1/4 x 1 3/4	2.18	400	20	3.5	9	18	21	26	35	920	1108	1315	1470	1650	1840	2200	2560	2940	3300	3700	4620	5500	
140	1 1/2 x 2	2.5	350	19	3.2	8	16	20	24	32	840	1028	1180	1340	1510	1680	2050	2350	2680	3000	3380	4200	5050	
125	1 1/2 x 1 1/2	2.25	380	20	3.3	8	16	21	25	33	870	1040	1210	1400	1580	1730	2100	2420	2880	3120	3500	4400	5250	
150	1 1/2 x 1 3/4	2.64	330	18	2.9	7	14	19	22	29	760	910	1130	1220	1360	1530	1840	2100	2450	2750	3050	3800	4650	
200	1 1/2 x 2	3.0	290	17	2.42	6	12	15	18	24	630	765	890	1020	1150	1265	1522	1780	2050	2380	2850	3200	3640	
300	2 x 2	4.0	215	15	1.87	5	9	12	14	19	490	590	690	780	880	980	1180	1360	1570	1760	1950	2350	2940	
400	2 x 2 1/2	5.0	175	14	1.62	4	8	10	12	15	395	470	550	640	710	790	950	1110	1265	1420	1590	1980	2400	
500	2 x 3	6.0	145	13	1.26	3	6	8	9	12	330	395	455	530	595	660	790	920	1060	1200	1330	1650	2000	

will be needed. This may be expressed as:

$$\frac{E_p}{E_s} = \frac{T_p}{T_s}$$

It is often more convenient to take the figure obtained for the primary winding and, by dividing by the supply voltage, the number of turns per volt is calculated. This accomplished, the number of turns for any given voltage can be calculated by simple multiplication.

Radio transformers are generally of small size. The matter of power factor can therefore be disregarded, more especially because they work into an almost purely resistive load. In the design of radio transformers, the power factor can be safely assumed as unity, in which case the apparent watts and the actual watts are the same. Admittedly, this is not always a correct assumption, but it will suffice for common applications.

The size of the wire to be used in any transformer depends upon the amperage to be carried. For a current of 1 ampere as a continuous load, at least 1,000 circular mils per ampere must be allowed. For transformers which have poor ventilation, or continuous heavy load service, or where price is not the first consideration, 1,500 circular mils per ampere is a preferable figure. If, for example, a transformer is rated at 100-watts primary load on 110 volts, the current will be

$$I = \frac{W}{V} = \frac{100}{110} = 0.90 \text{ amperes}$$

and if the assumption is 1,000 circular mils per ampere, it will be found that this will require $1,000 \times .90$, or 900 circular mils. The wire table on page 455 shows that no. 20 wire for 1,200 mils is entirely satisfactory. If it is desired to use 1,500 circular mils, instead of 1,000, this will require $1,500 \times .90$ or 1350 mils, which corresponds to approximately no. 19 wire. The difference seems to be small, yet it is large enough to reduce heating and to improve overall performance. Assume, for tentative design, a 600-volt, 100-ma. high-voltage secondary; a 3-ampere 5-volt secondary, and 2.5-volt 7.5-ampere secondary. Simple calculation will show a 60-watt load on the high-voltage secondary; 15 watts on the 5-volt winding, and 16 watts on

the 2.5-volt winding, a total of 91 watts. The core and copper loss is 10 watts. The wire sizes for the secondaries will be for 100-ma. current, no. 30 wire; 3 amperes at 5 volts, no. 15 wire; no. 11 wire for the 7.5-ampere secondary.

For high-voltage secondary windings, a small percentage of turns should be added to overcome the resistance of the small wire used, so that the output voltage will be as high as anticipated. The figures given in the table include this percentage which is added to the theoretical ratio and, consequently, the number of turns shown in the table can be accepted as the actual number to be wound on the core of any given transformer.

Allowance should always be made for the insulation and size of the windings. Good insulation should be provided between the core and the windings and also between each winding and between turns. Numerous materials are satisfactory for this purpose; varnished paper or cloth, called empire, is satisfactory, although costly. Good bond paper will serve well as an insulating medium for small transformer windings.

Insulation between primary and secondary and to the core must be exceptionally good, as well as the insulation between windings. Thin mica or mica-nite sheet is very good. Thin fibre, commonly called fish paper, is also a good insulator; bristol board, or strong, thin cardboard may also be used. In all cases, the completed coil should be impregnated with insulating varnish, and either dried in air or baked in an oven. Common varnishes or shellac are unsatisfactory on account of the moisture content of these materials. Air-drying insulating varnish is practical for all-around purposes; baking varnish may be substituted, but the fumes given off are inflammable and often explosive. Care must be exercised in the handling of this type of material. Collodion and banana oil lacquer are positively dangerous, and in the event of a short circuit or transformer burn-out, a serious fire may result.

If it is desired to wind a transformer on a given core, it is much better to calculate the actual space required for the windings, then determine whether there is enough available space on the core. If this precaution is not observed, the designer may find that only about half

the turns can actually be wound on the core, when the work is about three-fourths finished. From 15 to 40 per cent more space than calculated must be allowed. The winding of transformers by hand is a space consuming process. Unless the builder is an experienced coil-winder, there is every chance that a siz-

able portion of the space will be used up by insulation, etc., not sufficient space remaining for the winding. Calculate the cubical space needed for the total number of turns, and allow from 15 to 40 per cent additional space in the core window. Thereby much time and labor will be saved.

FILTER CHOKE CONSIDERATIONS

A choke is a coil of high inductance. It offers an extremely high impedance to alternating current, or to current which is substantially alternating, such as pulsating d.c. delivered at the output of a rectifier.

Choke coils are used in power supplies as part of the complete filter system in order to produce an effectively-pure direct current from the pulsating current source, that is, from the rectifier. The wire size of the choke must be such that the current flowing through it does not cause an appreciable voltage drop due to the ohmic resistance of the choke; at the same time, sufficient inductance must be maintained to provide ample smoothing of the rectified current.

Smoothing Chokes

The function of a smoothing choke is to discriminate as much as possible between the a.c. ripple which is present and the desired d.c. that is to be delivered to the output. Its air gap should

be large enough so that the inductance of the choke does not vary materially over the normal range of load current drawn from the power supply, but no larger than necessary to give maximum inductance at full current rating.

Swinging Chokes

In certain radio circuits the power drawn by a vacuum tube amplifier can vary widely. Class-B audio amplifiers are good examples of this type of amplifier. The plate current drawn by a class-B audio amplifier can vary 1000 per cent or more. It is desirable to keep the d.c. output voltage applied to the plate of the amplifier as constant as possible and the voltage should be independent of the current drawn from the power supply. The output voltage from a given power supply is always higher with a condenser input filter than with a choke-type input filter. When the input choke is of the *swinging* variety, it means that the inductance of the choke varies widely with the load current drawn from the

CHOKE TABLE FOR TRANSMITTER POWER SUPPLY UNITS

CURRENT M.A.	WIRE SIZE	NO. TURNS	LBS. WIRE	APPROX. CORE (Area)	AIR GAP	WT. CORE
200	No. 27	2000	1.5	1 1/2" x 1 1/2"	3/32"	4 lbs.
250	No. 26	2000	1.75	1 1/2" x 2"	3/32"	5 lbs.
300	No. 25	2250	2	2" x 2"	1/8"	6 lbs.
400	No. 24	2250	3	2" x 2 1/2"	1/8"	7 lbs.
500	No. 23	2500	4	2 1/2" x 2 1/2"	1/8"	10 lbs.
750	No. 21	3000	6	2 1/2" x 3"	1/8"	14 lbs.
1000	No. 20	3000	7.5	3" x 3"	1/8"	18 lbs.

NOTES: These are approximately based on high-grade silicon steel cores, with total air gaps as given. Air gaps indicated are total of all gaps.

The use of standard "E" and "I" laminations is recommended. If strips are used, and if an ordinary square core is used, the number of turns should be increased about 25%. Choke coils built as per the above table will have an approximate inductance of 10 to 15 henrys. Because considerable differences occur due to winding variations, allowable flux densities of cores, etc., the exact inductance cannot be stated; these chokes will, however, give satisfactory service in radio transmitter power supply systems.

The wire used is based on 1000 circular mils per ampere; this will cause some heating on long runs, and if the chokes are to be used continuously, as in a radiotelephone station in continuous service, it is good practice to use the next size larger choke shown for such loads.

power supply, due to the fact that high initial inductance is obtained by utilizing a "butt" gap, or none at all as in a transformer core.

Choke Design and Construction

A choke is made up from a silicon-steel core which consists of a number of thin sheets of steel, similar to a transformer core, but wound with only a single winding. The size of the core and the number of turns of wire, together with the air gap which must be provided to prevent the core from saturating, are

factors which determine the inductance of a choke. The relative sizes of the core and coil determine the amount of d.c. which can flow through the choke without reducing the inductance to an undesirable low value due to magnetization.

The same core material which is used in ordinary radio power transformers or from those which are burned out, is satisfactory for all general purposes.

In construction, the choke winding must be insulated from the core with a sufficient quantity of insulating material so that the highest peak voltages which are to be experienced in service will not rupture the insulation.

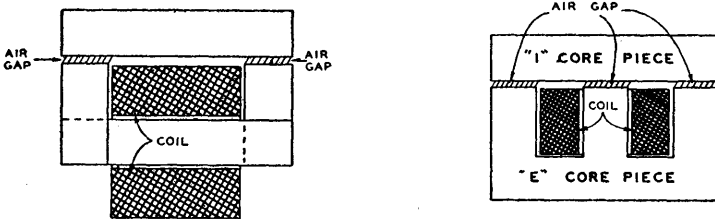

Figure 35. Two types of choke coil construction. The air gap is approximately 1/32-inch. The gap may be filled with non-magnetic material, such as brass, bakelite, etc.



DANGER—HIGH VOLTAGE

The high voltage power supplies even in a low-power transmitter are potentially lethal. They are also potential fire hazards. Pages could be written on "don'ts" and precautionary measures, but the important thing is to *use your head*; don't fool with any part of your transmitter or power supply unless you know exactly what you are doing and have your mind on what you are doing.

Not only should your transmitter installation be so arranged to minimize the danger of accidental shock for your own safety, but also because "haywire" installations that do not pass the underwriters' rules will invalidate your fire insurance. You have no claim against the insurance company if they can prove that the installation did not meet underwriters' specifications.

Some of the most important things to remember in regard to the high voltage danger are the following:

Do not rely upon bleeders to discharge your filter condensers; short the condenser with an insulated-handle screwdriver before handling any of the associated circuits. Bleeders occasionally blow out, and good filter condensers hold a charge a long time.

Beware of "zero adjuster" devices on meters placed in positive high-voltage leads. Also be careful of dial set screws if the rotor shaft of the condenser is "hot." Both of these situations represent poor practice to begin with.

Don't touch any transmitter components without first turning off all switches. If you do insist on making coupling adjustments, etc., with the transmitter on (very bad practice), keep ONE HAND BEHIND YOU.

Do not work on the high-voltage circuits or make adjustments where it is necessary to reach inside the transmitter UNLESS SOMEONE ELSE IS PRESENT. Ninety per cent of the deaths of amateurs due to electrocution could have been prevented if someone had been present to kill the high voltage or remove the victim and to call the doctor and administer first aid before he arrived.

High-voltage gear should be so fixed that small children cannot manipulate the switches or come in contact with any of the wires or components. Either keep the radio room or gear under lock and key or else provide an "interlock" system whereby all primary circuits are broken when the transmitter cabinet is opened.

Familiarize yourself with the latest approved methods of first aid treatment for electrical shock. It may enable you to save a life some time.

Don't attempt to hurry too much if a companion comes in contact with high voltage and cannot extricate himself. Act quickly but do not act without deliberation or you may be in as bad a fix as the person you are trying to help. Do not touch the victim with your bare hands if things are wet. Otherwise, it is safe to grab him by a loose fold of clothing to pull him free, first making sure that you are well-insulated from anything grounded. Turning off the voltage is simpler, when possible. However, do not waste precious moments dashing around trying to discover how to open the circuit. If you do not already know, try to remove the victim if it can be done safely.

A main primary switch at the entrance to the radio room, killing all primary circuits, will reduce the fire hazard and help your peace of mind, provided you make it an iron-clad rule always to throw the switch when leaving the room.

Beware of strange equipment. It may contain unconventional wiring or circuits. Do not take for granted that it is wired the way you would do it.

(Also refer to F. C. C. Standards of Good Engineering Practice in Appendix.)

CHAPTER 18

Test Equipment

Frequency Meters—C. W. and Phone Monitors—Volt-Ohm-meters—V. T. Voltmeters—Signal Generators—Modulation Checkers—Oscilloscopes and Sweep Circuits—Construction and Calibration

CERTAIN pieces of test equipment should be a part of every radio station and laboratory, in order to insure proper operation of radio receivers, transmitters, amplifiers, antenna systems, etc., and to diagnose trouble when it occurs. Other pieces of test equipment, while very handy and undoubtedly desirable, are not absolutely necessary and may be considered somewhat of a luxury. Every amateur should possess a simple ohmmeter, absorption wavemeter and monitor. The last can be designed and calibrated to act as a frequency meter. How much additional test equipment an amateur is justified in acquiring depends upon the condition of his pocketbook, the amount of money otherwise invested in his station and his ingenuity and resourcefulness. Some amateurs can

diagnose trouble and determine whether their equipment is operating properly by means of a single meter, a few resistors and various parts from the junk box, though the job would undoubtedly be facilitated by a more extensive array of test equipment. Other amateurs, particularly those less technically inclined, will find more need for various special-purpose test instruments when trouble hunting or tuning up a transmitter; in fact, they will be helpless without such instruments.

Practically everything in the way of test equipment of use to the amateur is described in this chapter. The units have been designed with simplicity and economy in mind, but not at the expense of reasonable accuracy or versatility.

ABSORPTION-TYPE WAVEMETER

The wavelength of any oscillator, doubler or amplifier stage can be roughly determined with the aid of a simple absorption wavemeter. It is particularly useful for determining the correct harmonic from a harmonic crystal oscillator or frequency doubler or quadrupler. It consists of a simple tuned circuit which is coupled to the tank circuit under measurement. The wavemeter absorbs a small amount of energy from the transmitter tank circuit; this produces a change in reading of the milliammeter in the plate or grid circuit. A sharp rise or dip in the milliammeter current reading will take place when the wavemeter is tuned to the

same wavelength or frequency as that of the circuit under measurement.

The coil socket is bolted to the back mounting flange of the 140- μ fd. midget variable condenser. One coil covers from 8 to 30 meters, another from 30 to 95 meters. The coil turns should be held in place with duco cement.

The wavemeter can be calibrated by holding it near the secondary coil of an ordinary regenerative receiver which tunes to the known amateur bands. As the wavemeter condenser is rotated through its range, a point will be found where the receiver is pulled out of oscillation, as indicated by a sharp click in the

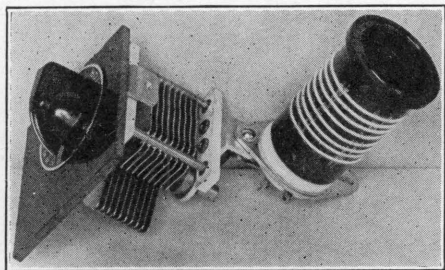

Figure 1. Simple absorption type wavemeter, useful for identifying harmonics. Two plug-in coils cover from 8 to 95 meters. The meter is merely a calibrated tank circuit.

headphones of the receiver. This point is then marked on the scale of the wavemeter dial. This calibration is sufficiently accurate to insure transmitter operation in the 10-meter band rather than 13-meter operation, which can be easily mistaken for 10-meter output when tuning a transmitter.

DIODE-TYPE FIELD-STRENGTH METER

The most practical method of tuning any antenna system, such as a half-wave antenna or a directional array, is by means of a field-strength meter. This instrument gives a direct indication of the actual field strength of a transmitted signal in the vicinity of the antenna. The

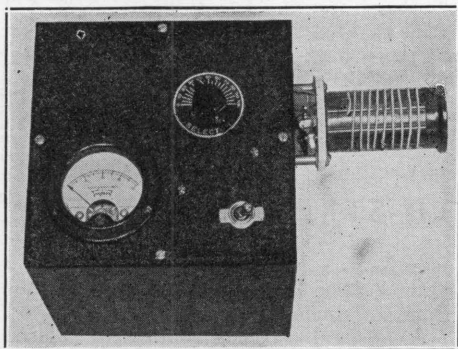

Figure 3. This simple field-strength meter uses a type 30 connected as a diode; a 0-200 microammeter provides good sensitivity. The unit can be used as an absorption wavemeter if calibrated. It can also be used as a neutralizing indicator.

The wavemeter can also be calibrated by holding it near the plate coil of a crystal oscillator. A change in oscillator plate current or even a cessation of oscillation will occur when the wavemeter is tuned to the same frequency as that of the oscillator.

One can either make a continuous calibration curve for the two coils or make notes of the dial settings for the various amateur bands.

Figure 2. Nothing could be simpler than the circuit of an absorption type wavemeter. For the range of from 8 to 30 meters, L should consist of 8 turns 1" long on a 1 1/4"-diameter form. For 30 to 95 meters, L should consist of 27 turns 1" long on a 1 1/4"-diameter form.



device consists of a tuned circuit and a diode rectifier which is connected in series with a microammeter so that the meter will read the carrier signal strength.

A 0-200 microammeter as an indicator provides higher sensitivity than can be obtained with the more common 0-1 ma. meter ordinarily used for this purpose.

The unit is very inexpensive and requires but a single 1 1/2-volt cell for power. Besides serving as a field-strength meter, it can be used as a neutralizing indicator or calibrated for use as an absorption wavemeter. A type 30 tube may be used. The 30 filament is rated at 2 volts, but in actual practice works

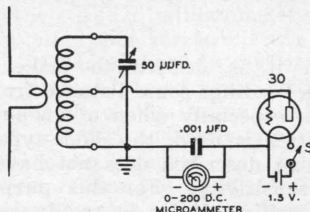

Figure 4. Wiring diagram of the simple field-strength meter.

well at 1½ volts. The entire unit, except coils and coil socket, is housed in a metal can 6" square. The externally mounted coil facilitates coil changing and better adapts the unit for use as a wavemeter, no antenna or pick-up wire being necessary in this application.

For service as a field-strength meter, the coil can be coupled to a small doublet by means of two or three turns of insulated wire wound around the coil. The instrument will be most sensitive if the pickup doublet is made resonant; but such a resonant doublet may, if it is closer than two or three wavelengths, upset the operation of the antenna being adjusted.

DIODE FIELD-STRENGTH METER

160 λ	88 turns #26 d.c.c. 1½" diam. closewound center tap
80 λ	38 turns #22 d.c.c. 1½" diam. closewound center tap
40 λ	24 turns #22 d.c.c. 1½" diam. 1½" long center tap
20 λ	10 turns #22 d.c.c. 1½" diam. 1½" long center tap
10 λ	6 turns #22 d.c.c. 1½" diam. 1" long center tap
5 λ	2 turns #18 enam. 1½" diam. ¾" long center tap

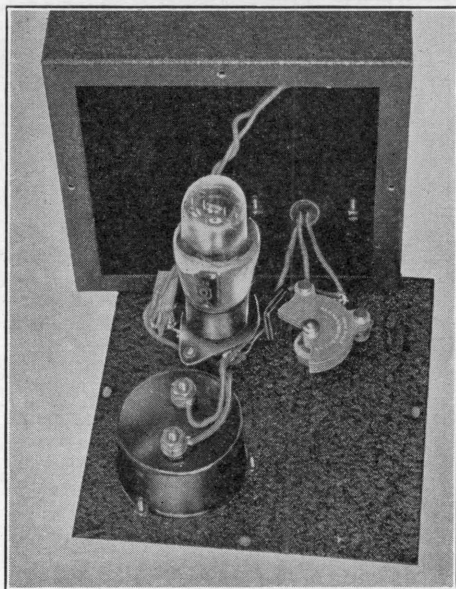

Figure 5. There are few components inside can housing the diode-type field-strength meter. A single "little six" dry cell is strapped inside the cabinet and supplies 1½ volts to the filament of the type-30 tube, used as a diode rectifier.

The meter illustrated was checked against a signal generator. With a type-30 tube in the meter, the following calibration in terms of decibels was obtained, using 12½ μa. as an arbitrary zero db reference level:

12½ μa.— 0 db	100 μa.—15 db
25 μa.— 5 db	150 μa.—18 db
50 μa.—10 db	200 μa.—20 db

HIGH-SENSITIVITY FIELD-STRENGTH METER

When it is desired to make field-strength readings some distance from the antenna, especially when a low-powered transmitter is used, the diode-type field meter just described does not have sufficient sensitivity. For this purpose a more sensitive device is required. The field-strength meter illustrated in figure 6 and diagrammed in figure 7 is considerably more sensitive, but requires a

plate battery and a more expensive tube than the diode type previously described.

A 1B4 tube, triode connected, is used as a detector. Two small batteries are required for the plate, filament and bias supplies. The plate voltage is 22½ volts, the bias about 2½ volts and the rated filament voltage, 2 volts. In normal use, the batteries shown with the unit should give a useful life of several months. As

Figure 6. This field-strength meter is more sensitive than the one pictured in figures 3 and 5, but requires more batteries.

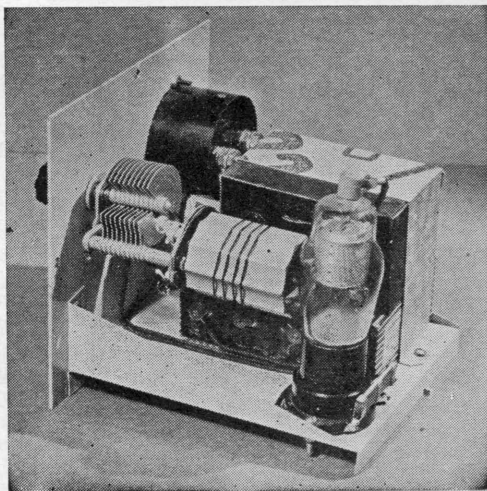

the batteries become aged, the calibration will change.

The one tuned circuit in the meter is designed to cover any two consecutive amateur bands. A single 140- μfd . condenser is used across the plug-in coil, and since the minimum-to-maximum variation in capacity across the coil (the sum of the condenser capacities plus the distributed circuit capacities) is from about 35 to 150 μfd ., it is possible to tune through any two consecutive bands. (A capacity variation of four-to-one is necessary to tune across two consecutive bands with a single coil.)

In the unit shown, one coil is used to

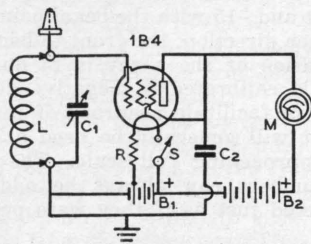

Figure 7. Wiring diagram of the sensitive f.s. meter.

- | | |
|---|---|
| C_1 —140- μfd . mid-gate variable | B_1 —4½-volt C battery. Filament leads connected to + and —3, ground connected to —4½ |
| C_2 —0.02- μfd . mica | B_2 —22½-volt C battery |
| R —15-ohm resistor | L —Coils—see text |
| S —On-off switch, s.p.s.t. toggle | |
| M —0-1 d.c. milliammeter (2" size to use chart given) | |

cover 10 and 20, another to cover 40 and 80, and still another coil to cover the 160-meter band. All coils are wound on 1½"-diameter coil forms with the tops sawed off to make the forms themselves (exclusive of their plugs) about 1¾" in length. It is necessary to shorten the coil forms since they are mounted horizontally on the back of the tuning condenser between the condenser and the 1B4 tube. The 10-20-m. coil contains 4 turns spaced to about ¾"; the 40-80-m. coil is of 15 turns closewound, and the 160-m. coil is of 40 turns, closewound. All coils are wound with no. 20 wire; the 10-20 one is wound with enamelled and the other two with d.c.c. Both of the two-band coils (10-20 and 40-80) will hit the lower-frequency band with the condenser plates almost completely meshed, and the higher-frequency band with them almost separated. Enough range is left, however, so that the bands may easily be covered from one end to the other.

When the unit is first turned on, if the batteries and the tube are in good condition, the 0-1 d.c. milliammeter in the common plate and screen circuit of the 1B4 will indicate about 50 microamperes of plate current. In an r.m.s. voltage indicator (of which this meter is a special type), it is always advisable to have some no-signal plate current.

Now, to return the meter to the zero position with this .05 ma. flow going through it, it is only necessary to turn the zero-adjustment screw until the needle points to zero with the meter in

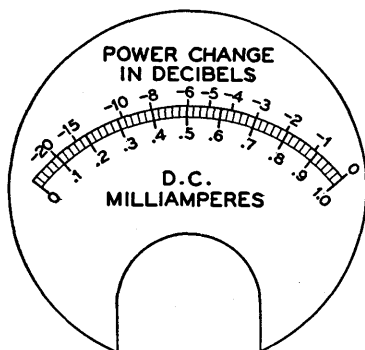

Figure 8. This scale can be used for converting current readings to decibels, or it may be pasted directly on the face of a two-inch meter.

operation. Then, the fact that the meter will always point to zero when all components are in adjustment will serve as a check on the calibration and condition of the batteries. However, as soon as the meter is turned off, the pointer of the milliammeter will fall below the zero on the scale—actually it will rest upon the pin on the zero side of the meter.

If this instrument is duplicated accurately, the meter will be practically linear, and readings on the 1-ma. meter can be converted to decibels by referring to figure 8. Or, if a 2-inch 1-ma. Triplett meter is used, the scale in figure 8 may be cut out and pasted directly on the meter face.

If a short length of wire is used for pickup, it may be connected directly to the antenna post, which is a standoff insulator on the top of the cabinet, wired directly to the 1B4 grid. If it is impossible to get a substantial deflection with a short length of wire, the case of the instrument should be grounded and a longer piece of wire connected to the an-

tenna post through a 3-30 μ fd. mica trimmer used as a pickup. If the trimmer is not used, a long pickup antenna will detune the meter appreciably.

The tuning condenser C_1 can be detuned from resonance if too great a deflection is obtained. It is not necessary that the tank be tuned to resonance for field-strength measurements, though the meter will be most sensitive when C_1 is tuned to exact resonance.

If the instrument is used as a wave-meter, the calibration should be made with a short, rigid piece of wire as a pickup. The same wire should then be used whenever subsequent wavelength measurements are made. This wire or rod need not be over a few inches long, as it will receive sufficient pickup when brought near the tank circuit whose frequency is to be determined.

The meter is almost indispensable in the adjustment of certain types of antennas. Consider the tuning-up of a rotatable array of the close-spaced type. The meter is placed in a vacant lot some distance from the antenna (two or three wavelengths is usually ample distance), tuned to resonance with its small pickup antenna in place, and the array is pointed toward the f.s. meter. The reading in decibels is noted. The meter should be near enough to the array to give a reading close to full scale. Then the array is rotated and the new reading in decibels noted. The front-to-back ratio of the array is then the difference between the two readings on the meter. If the meter reads -1 db with the array pointed toward it and -15 with the beam pointed in the other direction, the front-to-back discrimination of the array is 14 db. The meter is calibrated in negative decibels simply to facilitate accuracy of reading, since it will generally be used at readings approaching full scale. The negative numbers can always be added or subtracted just as if they were positive.

A. C. FREQUENCY METER-MONITOR

An accurate means for determining the frequency of a radio transmitter is essential when the circuit is of the self-excited oscillator type. The same device is useful for checking quartz crystal transmitters in order to make certain

that the crystal frequency falls within the desired amateur band. It is also a great help in finding a station whose exact frequency is known. "Sorry QRM is so bad; look for me on — kc."

The frequency meter consists of a very

stable electron-coupled oscillator which is accurately calibrated. This same unit can serve as a c.w. *monitor* by adding an audio amplifier stage to the plate circuit of the electron-coupled oscillator. The oscillator can be designed to cover either the 80- or 160-meter amateur bands, and harmonics of these frequencies can then be used for measurements in the shorter wave bands. The oscillator has a small tuning condenser shunted by a larger, bandsetting condenser; the latter is adjusted only when the frequency meter is calibrated from standard frequency transmissions or broadcast station harmonics in conjunction with a calibration oscillator. The condenser used is one particularly designed for such use. It is in reality two condensers built in a single frame, each rotor being individually adjustable. A good, finely-graduated vernier dial is essential for reading the setting of the smaller condenser for accurate determination of frequency. The instrument must be housed in a metal cabinet or can to prevent excessive pick-up from the transmitter under test. The electron-coupled oscillator functions as a beat-note detector similar to the one in a short-wave regenerative receiver.

Calibration

Standard frequency transmissions are broadcast in the amateur bands at regular intervals; schedules of the standard-frequency stations can be found in current issues of monthly amateur radio periodicals. These signals can be tuned in on a short-wave receiver and the frequency meter tuned to the zero beat-note in the output of the radio receiver. External coupling can be provided from the frequency meter oscillator, if necessary for sufficient pickup, by connecting a short piece of wire to the pin-jack provided for the purpose on the front panel, and running it close to the receiver antenna lead-in in order to pick up r.f. energy from the frequency meter.

If a superheterodyne is used for calibration purposes, care must be taken that the frequency meter is *not tuned to the image frequency response* of the radio receiver, but to the same frequency as that of the standard signal transmission. A calibration chart can be plotted so that a frequency range of 3,500 to 4,000 kc. is obtained. Harmonics of the oscillator can be determined accurately by multiplying the frequency readings

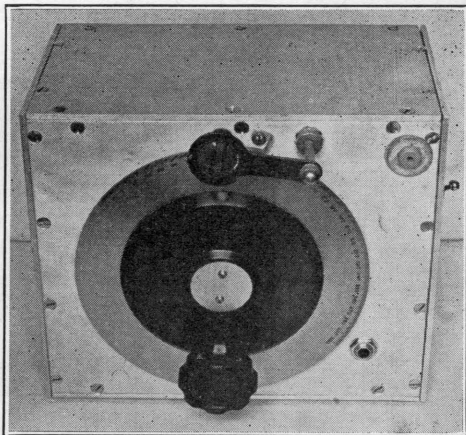

Figure 9. This heterodyne frequency meter has an audio amplifier stage following the electron-coupled oscillator so that it can be used as an effective c.w. monitor. A heavy, rigid cabinet and a large, vernier dial are necessary for accuracy when it is used as a frequency meter. The pin-jack at the upper right is wired to the output circuit of the oscillator and is used to connect an external "antenna" when sufficient pickup or radiation is not otherwise obtained.

from the chart by the number of the harmonic.

A typical calibration chart is shown in figure 14. Here it is seen that the dial reading 60 indicates frequencies of 3600, 7200, 14,400 and 28,800 kc., the latter three being the second, fourth and eighth harmonics of the generated signal if an 80-meter coil is used. If the frequency meter has a 160-meter coil, this same reading will also show a frequency of 1,800 kc. If the frequency meter is calibrated in the range of 3,500 to 4,000 kc., it does not matter whether a 160- or 80-meter coil is used in the electron-coupled oscillator circuit.

The frequency meter can be calibrated by means of a calibration oscillator and a broadcast receiver. The calibration oscillator is tuned to zero beat in the broadcast receiver with carrier signals from broadcast stations of known frequency. The harmonics of the calibration oscillator are coupled into the frequency meter and the latter is tuned to zero beat, as heard through headphones in the output of the monitor. An example would be where the local oscillator is tuned to zero beat with a broadcast station signal of 880 kc.; the fourth harmonic of the

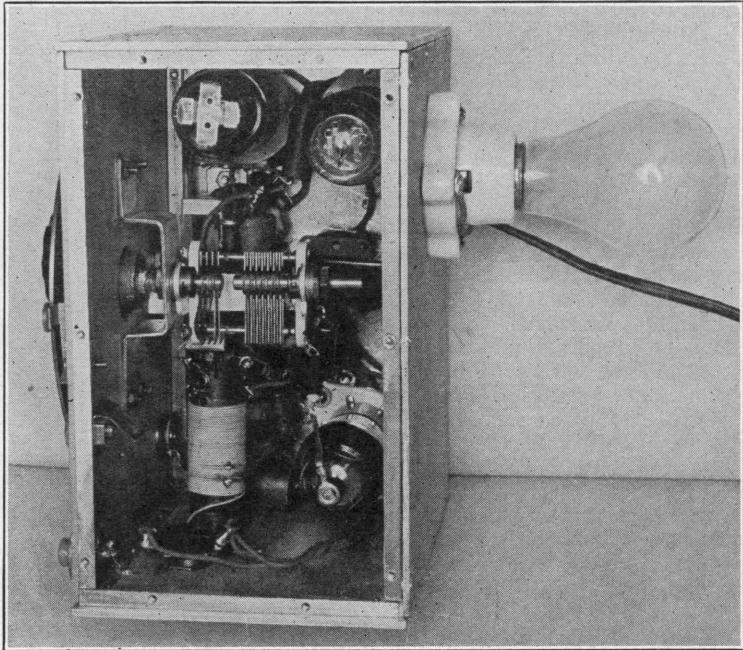

Figure 10. Looking down into the heterodyne frequency meter. A special bandspread condenser with lock nut on the bandset section is used. If desired, a line cord with built-in 320-ohm resistor, of the type used with a.c.-d.c. midgets, can be used in place of the Mazda lamp to drop the line voltage to a suitable value for the three series-connected tube heaters.

local oscillator would be four times 880 or 3520 kc. This value can be used to obtain a calibration point on the frequency meter. Zero-beating with broadcast stations is recommended as an accurate means of calibrating frequency

meters and monitors, since these stations always operate well within the allowed frequency tolerance of plus or minus fifty cycles.

Suggested circuits for calibration oscillators are shown in figures 12 and 13.

FIGURE 11. WIRING DIAGRAM OF THE COMBINED FREQUENCY METER AND MONITOR.

- C₁ C₂—special bandspread condenser, 50- μ mf. and 100- μ mf. sections with individually adjustable rotors and lock nut on bandset section
- C₃—100- μ mf. mica
- C₄—50- μ mf. mica
- C₅—0.1- μ mf. tubular
- C₆, C₇—0.005- μ mf. mica
- C₈—0.01- μ mf. tubular
- C₉, C₁₀—0.1- μ mf. tubular
- C₁₁, C₁₂—8- μ mf. 200-v. electrolytics
- C₁₃—0.01- μ mf. tubular
- R₁—500 ohms, 1 watt
- R₂—100,000 ohms 1/2 watt
- R₃, R₄—25,000 ohms, 1 watt
- R₅—100,000 ohms, 1 watt
- R₆—1 meg., 1/2 watt
- R₇, R₈—50,000 ohms, 1 watt
- B—40 watt Mazda bulb
- CH—30-hy. 30-ma. choke
- COIL—See text

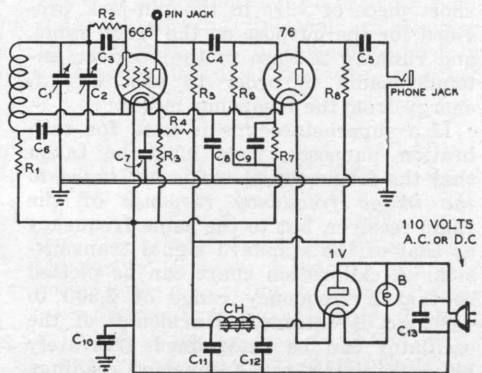

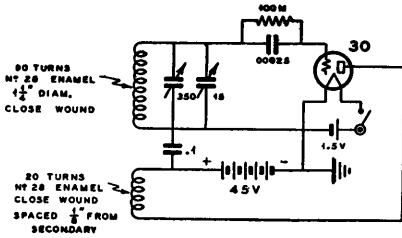

Figure 12. Calibration oscillator for battery operation. It generates a very stable carrier over the broadcast range.

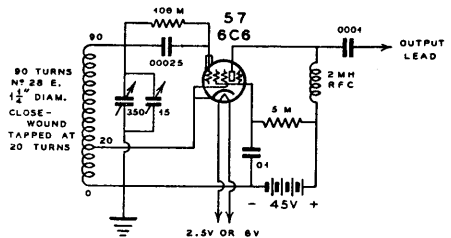

Figure 13. With heater type tubes, battery plate supply is still used with the calibration oscillator for the sake of stability.

Calibration oscillators can be built on small breadboards; they do not require shielding.

Before calibration is attempted, the bandsetting condenser C_2 is adjusted so that the 75-85-meter band is "centered" on the dial. If the coil specifications are followed carefully, it will be possible to cover the 3500-4000-kc. range with a little overlap at either end. The lock nut on the bandset portion of the condenser should then be tightened to insure permanency of the adjustment. The shield cover (cabinet) should be bolted in place before calibration is attempted, as its presence has an appreciable effect upon the frequency.

The calibration of the meter should be checked every few weeks, as aging of the components will affect the accuracy. Also,

while the meter is sufficiently accurate for most amateur purposes, one should not put faith in it to the extent of arguing with the Grand Island monitoring station as to whether you are just in or just out of the band.

The metal cabinet in which the meter is housed *must* be rigid and well built. The one illustrated is of 1/8" sheet aluminum and measures 7" high x 8" long x 5" deep. It is held together by a generous number of angle brackets and screws.

Because only 90- or 100-volts plate supply is required for operation of the frequency meter, it is possible to dispense with a power transformer in the manner of the popular "a.c.-d.c." midgets. The three 0.3-ampere tube heaters and a 40-watt Mazda lamp are connected in

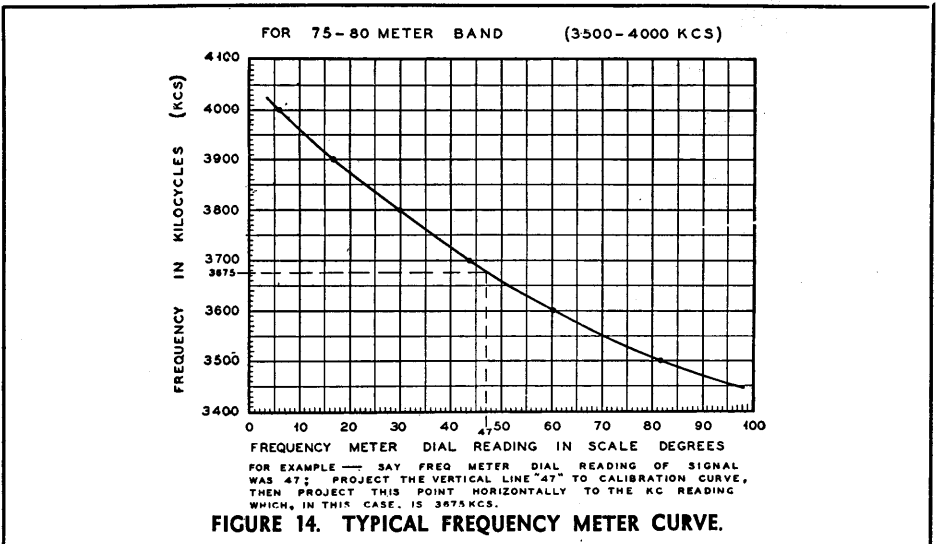

series to work directly from either 110 volts a.c. or d.c. The lamp is mounted outside the cabinet to prevent heating of the components which would affect the calibration. The heat transmitted to the components inside the cabinet by the lamp is less than a power transformer mounted inside the cabinet would generate.

The meter should always be allowed

to warm up a few minutes before calibrating it or taking a frequency measurement.

The oscillator coil consists of 37 turns of no. 22 d.c.c. spacewound on a $\frac{7}{8}$ "-diameter bakelite or ceramic form to cover $1\frac{1}{2}$ " of winding space. It is tapped at the 9th turn for the cathode connection. Duco cement should be applied to hold the turns firmly in place.

BANDSWITCHING C. W. MONITOR

A c.w. monitor is a useful adjunct to a c.w. station as a means of checking the emitted signals for chirps, excessive ripple, key clicks, tails and other undesirable characteristics. A shielded monitor enables the operator to tell from within the station how the radiated signal sounds at a distance.

The c.w. monitor illustrated in figures 15 and 16 incorporates a battery-type dual triode, one-half of which acts as an oscillating detector and the other half as an audio amplifier. To make plug-in coils unnecessary, bandswitching is employed. Three coils and a selector switch allow choice of 20-, 40- or 80-meter

operation at the flip of a switch.

A standard "Little Six" $1\frac{1}{2}$ -volt compact dry cell and a midget $22\frac{1}{2}$ -volt C battery are used for power supply. The filament battery will give well over 100 hours operation before requiring replacement, and the $22\frac{1}{2}$ -volt plate battery will outlast several filament batteries. Both filament and plate batteries are enclosed in the cabinet, but are not fastened to the front panel as the other components are. The shield can measures $5" \times 5" \times 9"$ and has just enough inherent leakage to allow pickup of a comfortable signal from a nearby transmitter. To prevent excessive pickup and blocking of the detector, the a.f. plate lead to the phones contains an r.f. choke to forestall pickup by way of the phone cords. If the transmitter is of low power giving insufficient signal strength for monitoring purposes, the r.f. choke can be left out of the phone cord circuit. This will raise the signal strength noticeably.

All three coils are wound on $1\frac{1}{2}"$ lengths of 1-inch bakelite tubing as illustrated in figure 16. All windings are of no. 24 d.c.c. except the 80-meter grid

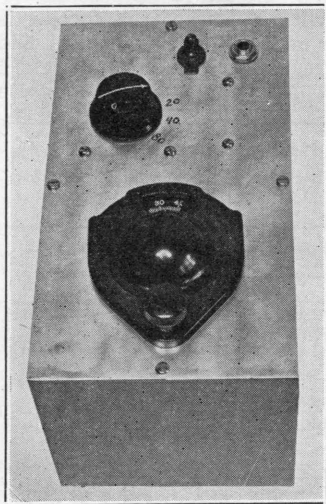

Figure 15. Bandswitching 20-40-80-meter c.w. monitor. It is powered by self-contained batteries. Because the drain on the batteries is low, the cost of operation per hour is very slight.

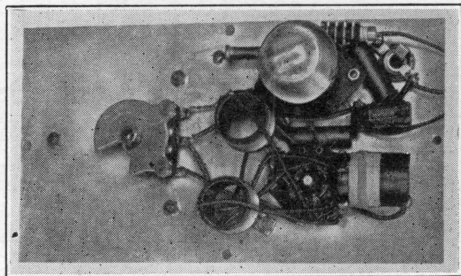

Figure 16. Back view of the c.w. monitor panel; all components except the batteries are supported by the panel.

coil, which consists of no. 26 enamelled.

The 20-meter coil consists of 9 turns spaced $\frac{1}{2}$ " for the grid winding and 6 turns closewound for the tickler. The latter is wound at the ground end of the grid coil, with very little spacing between the windings.

The 40-meter coil consists of 22 turns spaced 1" for the grid winding and 7 turns closewound for the tickler which is wound at the ground end of the grid

coil with very little spacing between the windings.

The 80-meter grid coil consists of 55 turns, closewound. The tickler is wound directly over the grid coil, near the grounded end of the latter, and is insulated from the grid winding by a layer of paper.

It should be borne in mind that unless the polarity of the tickler coils is correct, the detector will not oscillate.

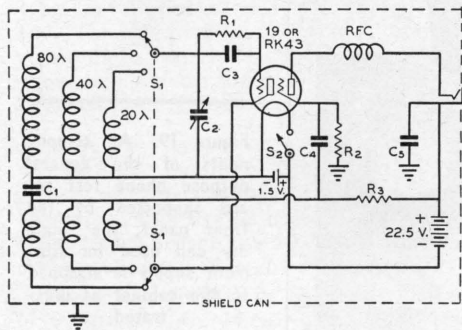

Figure 17. Wiring diagram of the band-switching c.w. monitor.

- | | |
|---|---|
| C ₁ —0.002- μ fd. mica | R ₅ —20,000 ohms, $\frac{1}{2}$ watt |
| C ₂ —50- μ fd. midget variable | S ₁ —Two-pole, three-position rotary switch |
| C ₃ —100- μ fd. mica | RFC—2 $\frac{1}{2}$ -mh. midget choke (omit if signal is not sufficiently strong with choke in circuit) |
| C ₄ , C ₅ —.01- μ fd. tubular | |
| R ₁ —0.5 meg., $\frac{1}{2}$ watt | |
| R ₂ —1 meg., $\frac{1}{2}$ watt | |

GENERAL PURPOSE PHONE TEST SET

A phone test set is quite similar to a field-strength meter, yet it lends itself to making additional measurements. It can be used as an overmodulation indicator, phone monitor, field-strength meter, neutralizing indicator and wavemeter.

This test set enables the operator to check for overmodulation of a phone transmitter. When the tuned circuit of the test set is coupled to the modulated amplifier or antenna system in such a manner as to obtain half-scale deflection of the milliammeter, any flicker of the meter reading will then be an indication of overmodulation. A change in meter reading during modulation is an indication of *carrier shift*, which will produce illegal interference in adjacent radio-phone channels.

Figure 18. This versatile instrument can be used as a phone monitor, an absorption wavemeter, field-strength meter overmodulation (carrier shift) indicator, or neutralizing indicator.

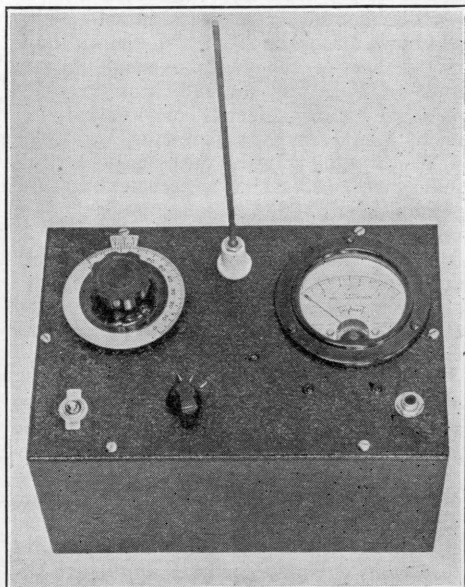

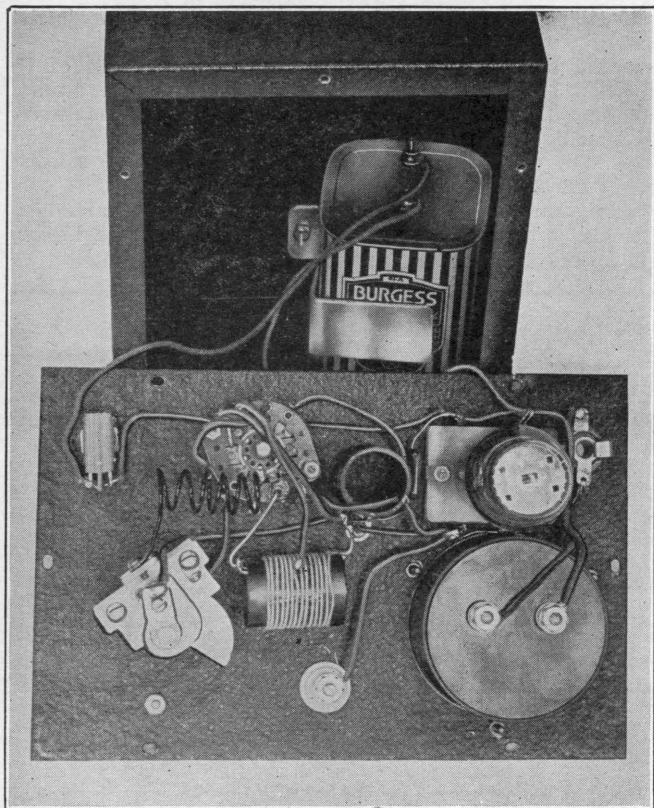

Figure 19. All components of the general purpose phone test set are supported by the front panel; the single dry cell used for filament supply is strapped to the cabinet as illustrated.

The phone test set consists of a diode rectifier connected across a tuned circuit, as shown in figure 20. A 0-1 d.c. milliammeter serves to check overmodulation, and is useful as an indicator in field-strength measurements or neutralizing adjustments in a transmitter.

The audio volume with half to full scale meter indication is sufficient to give normal headphone response. A 5,000-ohm resistor is connected into the jack circuit for use when the test set functions as an overmodulation indicator. This resistor is in series with the diode and tends to produce a more linear rectification of the carrier wave.

For neutralizing or field-strength measurements, a short-circuiting plug or brass rod should be inserted into the phone jack to short-circuit the 5,000-ohm resistor and thereby increase the sensitivity of the meter. Neutralizing adjustments are made by coupling the test set's tuned circuit to the transmitter stage under test (without plate voltage applied to the

stage). When the stage is completely neutralized, there will be either a minimum or zero deflection of the meter needle.

A short piece of brass rod, about 10 inches long, protrudes from the chassis as may be seen in figure 18; this rod acts as a pickup. For most purposes the signal pickup with this rod will be sufficient, but when the instrument is used for measuring field strength and there is insufficient meter deflection for an accurate reading, an auxiliary antenna consisting of several feet of insulated wire may be coupled to the pickup rod by wrapping one end of the insulated wire around the pickup rod a few times. The small amount of capacity coupling provided will be sufficient to give a higher meter reading but will not be enough to disturb the frequency of the tank circuit appreciably.

When using the instrument in the neutralization of an r.f. amplifier, a short piece of flexible wire, about 18 inches

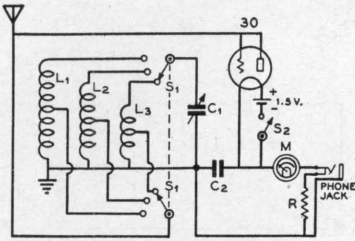

Figure 20. Wiring diagram of the phone test set.

- C₁—140- μ fd. mid-g et
- C₂—.001- μ fd. mica
- L₁, L₂, L₃—See text
- R—5000 ohms, 1/2 watt
- S₁—Two-pole, three-position rotary switch
- S₂—Toggle switch
- M—0-1 ma. d.c. 3" meter

long, is clipped directly to the pickup rod. The other end of the wire is brought closer and closer to the plate lead of the stage being neutralized until a substantial deflection is obtained.

Coil Data

The use of a 140- μ fd. tuning condenser permits use of one coil for 5 and 10 meters, another for 20 and 40 meters and another for 80 and 160 meters.

For 5 and 10 meters the coil consists of 5 turns of no. 14 wire, 1/2" diameter and spaced to occupy a length of 1 inch. This coil is self-supporting and is soldered directly to the coil switch and tuning condenser rotor.

The 20-40-meter coil consists of 14 turns of no. 22 d.c.c. spaced to 1 inch on a 1 1/8"-diameter form.

The 80-160-meter coil has 55 turns of no. 26 enamelled, closewound on a 1 3/8"-diameter form.

Calibration

If the instrument illustrated is duplicated carefully, there will be no need for plotting a calibration curve or table for the individual meter in terms of decibels. The following table will be sufficiently accurate (arbitrary zero db reference level taken as .05 ma. deflection).

0.05 ma.—0 db	0.60 ma.—16 db
0.10 ma.—4 1/2 db	0.70 ma.—17 db
0.20 ma.—8 1/2 db	0.80 ma.—18 db
0.30 ma.—11 db	0.90 ma.—19 db
0.40 ma.—13 db	1.00 ma.—20 db
0.50 ma.—14 1/2 db	

An individual frequency calibration must be made to cover use of the instrument as an absorption wavemeter. As a wavemeter, the instrument should be used only for rough measurements, such as determining the order of a harmonic.

A MULTIRANGE VOLT-OHMMETER

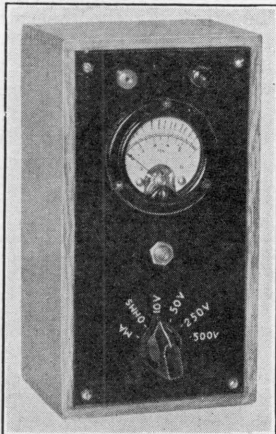

One of the most useful instruments is a simple ohmmeter for making continuity tests and for measuring the values of resistors. The same instrument can be combined into a multirange voltmeter by means of a rotary switch and a few resistors, as shown in the circuit, figure 23.

A 0-1 ma. d.c. milliammeter of the 2-inch size can be used in this test set by cutting out or reproducing the scale in figure 24 and pasting it over the existing meter scale.

The unit can be built into a small box,

Figure 21. This volt-ohmmeter is inexpensive, easy to construct, has many uses.

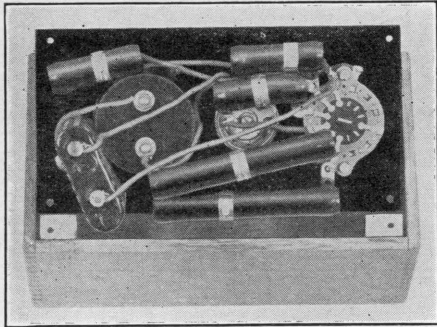

Figure 22. Interior view of ohmmeter, showing battery, rotary switch and precision (wirewound) resistors.

4" x 8" x 3 1/2", as shown in figures 21 and 22.

Continuity tests can be made by turning the switch to position 2; the device then acts as an ohmmeter which has a range from zero to approximately 100,000 ohms. The needle should be set to zero by means of the 1,000-ohm resistor, with the output leads short-circuited.

Resistance values may be obtained by reading the values directly on the uppermost scale. The ohmmeter proper consists only of the 0-1 d.c. milliammeter, a 4,000-ohm fixed resistor, a 1,000-ohm variable resistor and a 4.5-volt C battery. The unknown resistance is connected in series with this combination. The additional components shown in the photograph and circuit diagram are necessary only when the meter is used as a multirange voltmeter and 0-1 d.c. milliammeter.

The accuracy of the instrument as a voltmeter will be determined by the accuracy both of the meter itself and the series resistors.

With the tap switch on position 1, the meter movement will be burned out if the pin jacks are connected to a source of voltage greater than about 1 volt. For this reason, the position of the tap

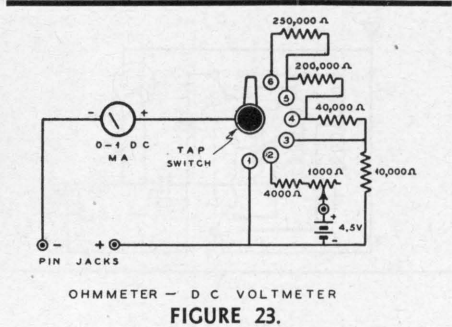

OHMMETER - D C VOLT METER
FIGURE 23.

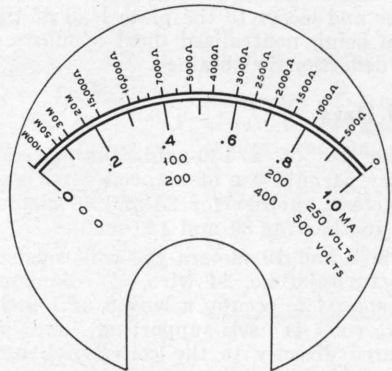

FIGURE 24.

- Position 1 of Switch.....0-1 ma.
- Position 2 of Switch.....0-100,000 Ohms
- Position 3 of Switch.....0-10 Volts
- Position 4 of Switch.....0-50 Volts
- Position 5 of Switch.....0-250 Volts
- Position 6 of Switch.....0-500 Volts

switch pointer should always be checked carefully before using the instrument as a voltmeter.

When measuring a voltage the general order of which is not known, the switch should be thrown to the 500-volt position and then switched to progressively lower scales until a readable deflection is obtained.

MEDIUM- AND LOW-RANGE OHMMETER

Most ohmmeters, including the one just described, are not adapted for accurate measurement of low resistances—in the neighborhood of 100 ohms, for instance.

The ohmmeter illustrated in figure 25 was especially designed for the reason-

ably accurate reading of resistances all the way down to one ohm. Two scales are provided, one going in one direction and the other scale going in the other direction because of the different manner in which the milliammeter is used in

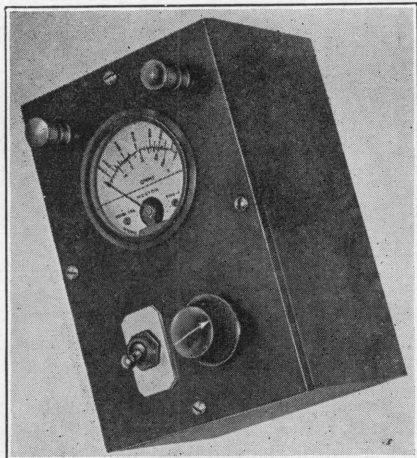

Figure 25. This ohmmeter is particularly useful for measuring resistances too low to be read accurately on an ohmmeter of the type illustrated in figures 21, 22 and 23.

each case. The low scale covers from 1 to 100 ohms and the high scale from 100 ohms to 10,000 ohms. The high scale is in reality a medium-range scale. For accurate reading of resistances over 10,000 ohms, the circuit of the ohmmeter previously described should be used.

The 1-100-ohm scale is useful for checking transformers, chokes, r.f. coils, etc. which often have a resistance of only a few ohms.

The calibration scale will depend upon the internal resistance of the particular make of 1.5-ma. meter used. The instrument can be calibrated by means of a Wheatstone bridge or a few resistors of known accuracy. The latter can be series-connected and parallel-connected to give sufficient calibration points. A hand-drawn scale can be pasted over the regular meter scale to give a direct reading in ohms.

Before calibrating the instrument or using it for measurement, the test prods should always be touched together and the zero adjuster set accurately.

Figure 26. Diagram of the low-range ohmmeter illustrated in figure 25.

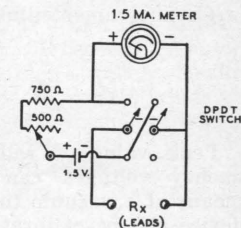

DIODE V. T. VOLTMETER

A d.c. voltmeter can be used for measuring peak a.c. voltages if a suitable rectifier and condenser are used in conjunction with the d.c. meter. The device illustrated in figure 28 and diagrammed in figure 27 can be used with any 1000-ohms-per-volt d.c. voltmeter to read peak a.c. volts. The 1-v tube acts as a peak-type diode rectifier.

Peak a.c. voltages up to 600 volts can

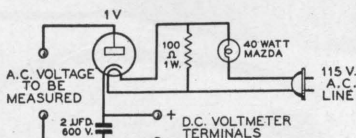

Figure 27. Wiring diagram of the diode peak rectifier.

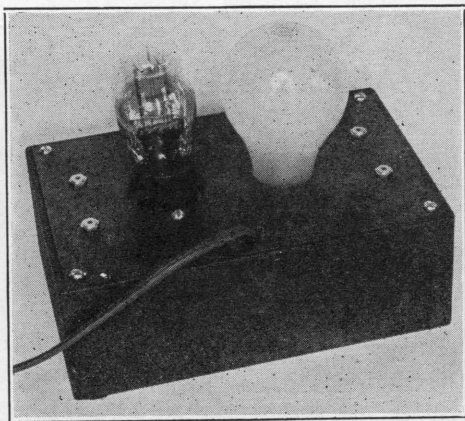

Figure 28. Diode rectifier for converting a d.c. voltmeter into an a.c. peak voltmeter.

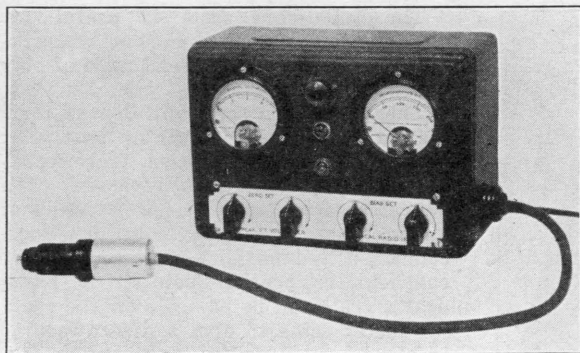

Figure 29. Front view of the peak v.t. voltmeter.

be applied safely to the instrument. The r.m.s. value of the a.c. voltage under measurement can be determined with good accuracy by multiplying the peak value as read on the meter by 0.71.

The instrument illustrated can be used

in conjunction with a d.c. voltmeter of suitable range to measure peak voltages across filter condensers and to check turns ratios of transformers, etc. It can also be used as an a.f. output meter when such a meter is required for checking a receiver or audio amplifier.

A. C.-TYPE V. T. VOLTMETER

Peak value of radio- and audio-frequency voltages can be measured by means of a vacuum tube voltmeter. This device can be calibrated from a 60-cycle source, and the same calibration curve will be satisfactory for radio-frequency measurements except at very high frequencies. A vacuum tube voltmeter is also very useful for aligning the circuits of a radio receiver. The device has nearly infinite input resistance. It con-

sists of a vacuum tube, operated with high grid bias. The tube acts as a rectifier or detector, and the change in plate current produced by the application of an external grid voltage is indicated by means of a microammeter. There are many types of vacuum tube voltmeters, one of which is shown in figures 29 to 32. The outstanding features of this device are: (1) a.c. operation, (2) good calibration stability, very nearly inde-

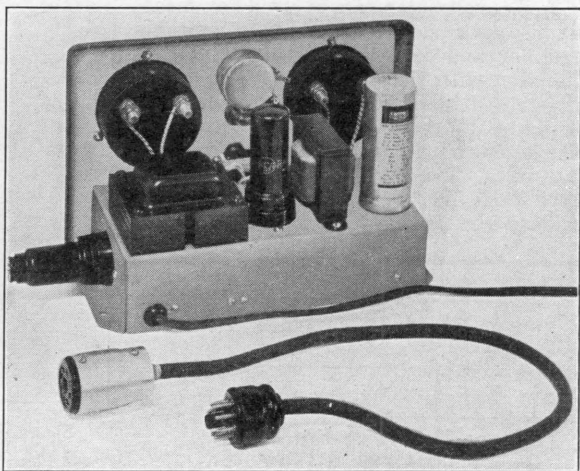
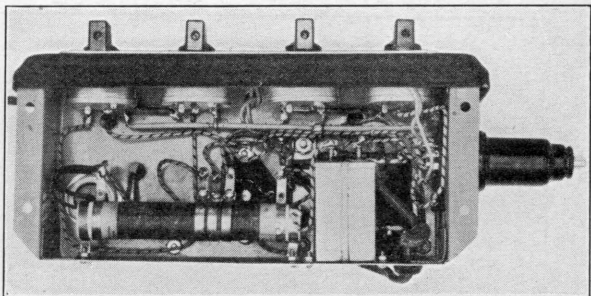

Figure 30. Showing layout of components.

Figure 31. Subchassis view of peak v.t. voltmeter.



pendent of moderate changes in line voltage, (3) high- μ 6F5 tube which can be plugged into the side of the metal cabinet for voltage measurements on the workbench or plugged into an extension cable for making r.f. tests where the length of grid and ground leads is of extreme importance, as in lining up r.f. amplifiers in radio receivers.

A 0-200 microammeter is operated at an initial deflection of approximately 10 microamperes or it can be used as a "slide-back" type of voltmeter with practically zero initial deflection. The input voltage should be balanced out by a change in the setting of the 6F5 grid bias potentiometers. The d.c. voltmeter

reading at this point is the actual peak input voltage. This type of measurement depends upon maintaining the microammeter reading at some fixed, low indication.

When this device is in operation, care must be taken to provide a d.c. path from the grid of the 6F5 to the chassis ground. If this is not done, there will be no bias on the 6F5 and the resulting high plate current will damage the microammeter. Most circuits under measurement will complete this path, which can be as high as several megohms without damage to the microammeter. The complete test set is housed in a commercially available metal cabinet of standard size.

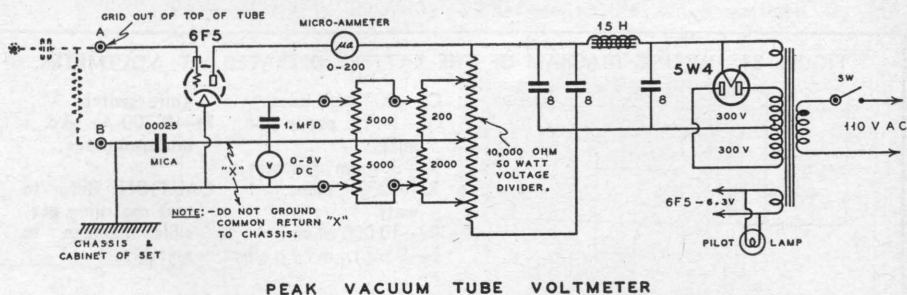

FIGURE 32.

BATTERY-TYPE V. T. VOLTMETER

A very simple battery-operated vacuum tube voltmeter is shown in figures 33 and 34. This type of meter can be calibrated by means of a potentiometer and low-reading a.c. voltmeter connected across a transformer filament winding. The a.c. voltmeter reads r.m.s. values which may

be converted arithmetically to peak values. For example, 1.2 volts r.m.s. equals 1.68 volts peak. The maximum peak voltage which can be measured by this instrument is not over 2 volts; the useful range is from about 0.5 to 1.8 peak volts.

The steady direct plate current

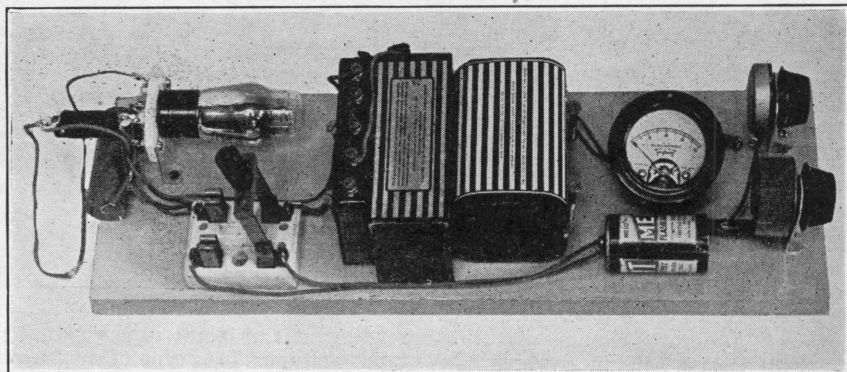

Figure 33. This battery-operated v.t. voltmeter is considerably less elaborate than the one previously illustrated, but has many useful applications around an amateur station.

through the meter to the 30 tube is balanced out by a bridge arrangement of resistors and a small flashlight cell. The 30-ohm rheostat R_1 has an off position and is turned on to protect the meter when the switch or the grid circuit is open. The same danger and considerations concerning an open grid circuit apply to this v.t. voltmeter as to the instrument previously described.

The range of the meter is from about 0.5 volt to 1.8 volts peak, and the accuracy is good on a.c. or on r.f. voltages

(except when the frequency is in the u.h.f. region). While greatest accuracy will be obtained by calibrating the individual instrument by means of known a.c. voltages, accuracy sufficient for all practical purposes may be obtained by using the following calibration, provided of course that the instrument is an exact duplicate of the one described.

30 μ a.—0.7 volts peak
 60 μ a.—1 volt peak
 120 μ a.—1.4 volts peak
 200 μ a.—1.8 volts peak

FIGURE 34. WIRING DIAGRAM OF THE BATTERY-OPERATED V.T. VOLTMETER.

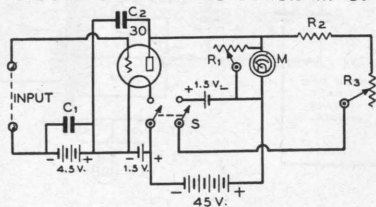

C_1 —.002- μ fd. mica
 C_2 —1- μ fd. paper tubular
 R_1 —30-ohm rheostat
 R_2 —5000 ohms, 1 watt
 R_3 —10,000 ohms
 S —D.p.s.t. mid gate

knife switch
 M —0-200- μ a. d.c. microammeter

CAUTION: Refer to text regarding possible damage to meter

BANDSWITCHING TEST OSCILLATOR

(Or Signal Generator)

A modulated test signal is required for lining up a superheterodyne receiver in order to simplify the procedure. The intermediate and tuned-radio-frequency circuits in the receiver must be properly aligned; a signal generator produces a signal similar to that of a weak radio signal, yet it is instantly available at any desired frequency.

The simple, one-tube modulated oscillator illustrated in figures 35 and 36 and diagrammed in figure 37 covers the range of 75 to 1500 kc. by means of bandswitching. Its harmonics can be used for work at still higher frequencies.

The oscillator circuit is a standard *Hartley* with a type RK-42 tube. A variable grid leak is controlled from the

front panel; this gives a means for obtaining either unmodulated or self-modulated carrier signals. High values of grid leak cause a blocking grid action, and the result is a test r.f. signal modulated at some audio frequency of 500 or 1,000 cycles. This grid leak resistor at low resistance values produces an unmodulated signal which simulates that of a c.w. signal.

A single 1.5-volt dry cell and a 22.5-v. C-battery furnish filament and plate potentials for the oscillator. The entire instrument, including the batteries, is contained in a metal can measuring 5"x5"x9". Any 350- or 375- μ fd. b.c.l. type variable condenser and dial may be used. The one used in the model illustrated is an old Remler b.c. condenser.

Level Control

A small portion of the r.f. voltage across the plate side of the tuned circuit is applied across a condenser type voltage divider consisting of a 3-30- μ fd. mica trimmer and a .0005- μ fd. fixed mica condenser. The trimmer is set near maximum capacity to give the optimum capacity ratio, a compromise between stability and maximum available output signal voltage. Across the .0005- μ fd. mica condenser is a 200-ohm poten-

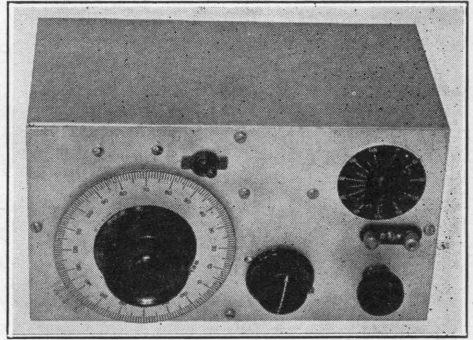
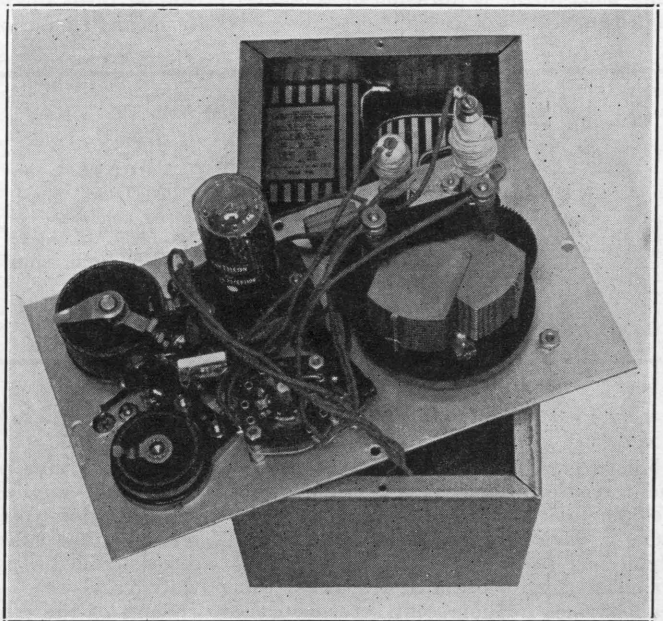

Figure 35. This test signal generator covers the range of from 75 kc. to 1500 kc. by means of bandswitching. It is important that the instrument be built in a metal can which shields it thoroughly.

tiometer, which is used as an attenuator to regulate the amplitude of the test signal. Variation in output level is obtained by this method without appreciably affecting the frequency of the oscillator. The effect of the potentiometer setting on the oscillator frequency can be further reduced by unscrewing the trimmer C_3 until the capacity is only about 5 μ fd. However, this reduces the amplitude of the maximum test signal voltage available.

The modulated wave emitted by the

Figure 36. Interior of the battery-powered test signal generator. Either a pure unmodulated or a modulated carrier wave can be obtained from the instrument. A continuously variable attenuator is provided for adjusting the output signal voltage to the desired level.



oscillator is rather broad but is suitable for most receiver alignment work.

Coil Data

All three coils are jumblewound on 1/2"-diameter porcelain insulator rods or wooden dowels, and are center-tapped. The number of turns for the various frequency ranges follow:

- 75-220 kc.—1100 turns no. 34 d.s.c. about 3/4" long.
- 200-500 kc.—450 turns no. 32 d.s.c. about 1/2" long.
- 500-1500 kc.—175 turns no. 26 d.c.c. about 1/2" long.

Calibration

The instrument is calibrated by coupling it into a radio receiver which can be tuned to broadcast stations in the frequency range of from 550 to 1,500 kc. The oscillator is tuned to zero beat with broadcast station signals of a known frequency.

The range of from 200 to 500 kc. can be calibrated in a similar manner by using the harmonics of the signal generator to produce zero beat. When a calibration scale is to be plotted, the frequency of the receiver can be divided by 2 or 3, depending upon whether the second or third harmonic of the oscillator is being used in the calibration of the long-wave range.

Operation

The long-wave ranges of this test oscillator are used to line up the i.f. circuits in superheterodyne receivers. The majority of receivers have an intermediate frequency of approximately 465 kc. The output terminals of the test oscillator can be connected to each stage of the i.f. amplifier in the radio receiver while that stage is being lined up. The last i.f. stage should be aligned first. The signal generator produces a steady tone-modulated signal which can be heard in the output of the radio receiver. The short-wave ranges of the oscillator are useful for lining up the h.f. oscillator, first detector and r.f. stages, so as to make them track properly. More details are given in the chapter on *Receiver Theory*.

The frequency of a quartz crystal, such as that used in a single signal receiver, can be determined very closely by setting the quartz plate on, or leaning it against, the grid of the oscillator tube. The oscillator frequency will suddenly change at resonance with the crystal, as will be heard in a broadcast receiver tuned to the second harmonic of the oscillator. This test requires a manipulation of both oscillator and broadcast receiver, but once the crystal frequency is found, the i.f. amplifier in the short-wave receiver can be lined up to this same frequency by means of the oscillator.

FIGURE 37. WIRING DIAGRAM OF THE TEST SIGNAL GENERATOR.

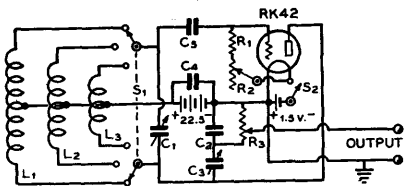

- C₁—0.0035 - or .00037-μfd. b. c. l. type condenser
- C₂—0.005-μfd. mica
- C₃—3-30-μμfd. mica trimmer
- C₄—0.01-μfd. tubular
- C₅—0.02-μfd. mica
- R₁—5000 ohms, 1 watt
- R₂—5-meg. pot.
- R₃—200-ohm pot.
- L₁, L₂, L₃—Refer to text

CATHODE-RAY OSCILLOSCOPES

Measurements of r.f. and a.f. voltage and wave form can easily be made with the aid of a cathode-ray oscilloscope. Such a device includes a vacuum tube which has two sets of deflecting plates for controlling a beam of electrons; this beam strikes a fluorescent screen on the

face of the tube and traces a pattern of the signal applied to the control grid or deflection plates. The fluorescent screen in the tube produces a visual indication of the pattern of r.f. or audio voltages.

Some of the many uses of the cathode

ray oscilloscope in its various forms are as follows:

- Measurement of d.c. voltage or current.
- Measurement of peak a.c. and r.f. voltage.
- Trouble-shooting in receivers.
- Adjustment of i.f. stages (including bandpass).
- Measurement of audio amplifier distortion, overload and gain.
- Adjustment phase-inversion circuits.
- Checking of power supplies.
- Checking of harmonic content.
- Measurement of phase angle and phase distortion.
- Measurements for dynamic tube characteristic curves.
- Checking of phone signals and per cent modulation by:
 - Modulation envelope
 - Trapezoidal pattern
 - Cat's eye pattern
- Making condenser power factor tests.
- Making overall frequency response tests.

Determining unknown frequencies.
 Adjusting auto vibrators.
 Studying surges and transients.
 Cathode-ray oscilloscopes are extremely useful for measuring percentage modulation and analyzing distortion in a radiophone transmitter.

While constructional data is given for two oscilloscopes, one a simple instrument for checking modulation in a radiophone transmitter and the other a more elaborate instrument possessing greater versatility, anyone contemplating construction of an oscilloscope should invest in one of the many excellent books on the subject, available very reasonably from *Rider, RCA Manufacturing Co., Dumont* and others. Because of space limitations, a comprehensive treatise on the theory, construction and use of oscilloscopes is not within the scope of this book. This will be appreciated when it is realized that there appear books on oscilloscopes which contain over 100 pages devoted to applications of the instrument alone.

C. R. MODULATION CHECKER

A very simple oscilloscope, such as the one shown in figures 38 and 39, is entirely satisfactory for modulation checking. It consists of an RCA-913 cathode-ray tube which has a fluorescent screen approximately one inch in diameter. This tube, and a suitable power supply, are built into a small metal cabinet measuring 5"x6"x9".

A dime magnifying glass obtainable at any five-and-ten-cent store gives a trapezoidal figure comparable in size to that of a 2" cathode-ray tube. The magnifying glass is held about 2 inches from the screen of the 913 by a piece of bakelite tubing which is slipped over the 913 and allowed to project slightly beyond the magnifying glass in order to keep out external light.

Three a.f. binding posts allow connection of the 'scope to the modulator of any phone transmitter with 5- to 1000-watts carrier power. No external coupling condenser is required; a lead may be connected directly to the class-C amplifier plate return circuit at the modulation transformer terminals. *Be-ware of the high voltage.* Connections

for a grid-modulated transmitter are similar, except that the modulation transformer connection is in the grid-return

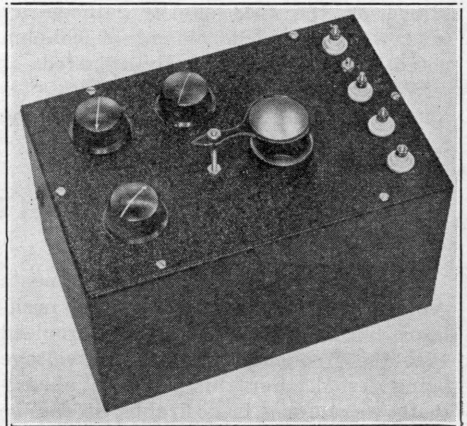
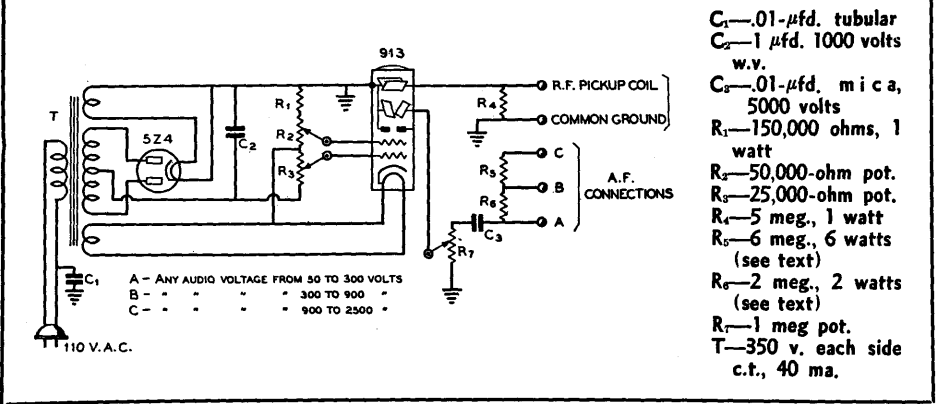

Figure 38. This inexpensive oscilloscope is useful for obtaining trapezoidal modulation patterns. A cheap magnifying glass and tubular shade to keep out external light give a pattern comparable to that obtained with a 2-inch c.r. tube.

FIGURE 39. WIRING DIAGRAM OF THE CATHODE-RAY MODULATION CHECKER.



instead of the plate return circuit of the r.f. amplifier. The resistor network adapts the instrument for use on any transmitter at a moment's notice; no trouble will be experienced in getting just the right amount of audio deflecting voltage.

The network resistors **R₅** and **R₆** are not standard items; each is made up of 1-megohm 1-watt carbon resistors in series, **R₅** requiring six such resistors and **R₆** two. The 1-watt resistors are mounted on terminal strips.

When a voltage is applied to only one set of plates, a thin straight line is obtained on the face of the cathode-ray tube when the 25,000- and 50,000-ohm potentiometers are correctly adjusted.

When a modulated carrier voltage is applied to one set of plates, and the

audio modulating voltage applied to the other, a *trapezoidal figure* will be produced during modulation. With 100 per cent modulation this pattern should be a straight-sided triangle, sharply pointed. Typical patterns are shown for plate and grid modulation in the accompanying sketches, figure 40.

The audio- or radio-frequency voltage should have an amplitude of at least 50 volts in order to cause good deflection on the screen. The amplitude should be sufficient to give a large pattern on the face of the tube. The 25,000- and 50,000-ohm potentiometers are adjusted to give sharp definition and a reasonable amount of illumination on the screen. The r.f. voltage can be secured by coupling a few turns of wire to the center of the modulated amplifier tank coil or to the antenna coupler.

C. R. 'SCOPE WITH SWEEP CIRCUIT

Most audio-frequency measurements require a variable frequency sweep oscillator circuit which can be synchronized with the frequency of the audio voltage being tested. For this purpose, a saw-tooth wave form is desirable; it can be obtained from a condenser-charge-and-discharge-circuit. The condenser is slowly charged, then rapidly discharged by means of a gas-filled type 885 triode which ionizes at a certain peak voltage

and short-circuits the condenser in the plate circuit.

The sweep circuit oscillation can be synchronized with that of the audio-frequency signal by applying a small portion of the latter to the grid circuit of the type 885 tube. The approximate frequency of the saw-tooth oscillator is adjusted by means of the capacity in the plate circuit of the tube and the value of the resistance in series with the B-plus lead from this tube. The output of this

oscillator must be amplified by a high-gain audio stage in order to provide sufficient voltage to produce a sweep across the screen of the cathode-ray tube.

The oscilloscope diagrammed in figure 41 contains vertical and horizontal deflection plate amplifiers, linear sweep and most of the adjuncts found in the most expensive oscilloscopes. The only differ-

ence is in the use of a small 913 one-inch c.r. tube for the sake of economy. A magnifying glass can be placed in front of the screen in conjunction with a tubular shade as explained in the constructional data on the oscilloscope previously described, to give a pattern equivalent in size to that obtainable with a 2-inch screen without the glass.

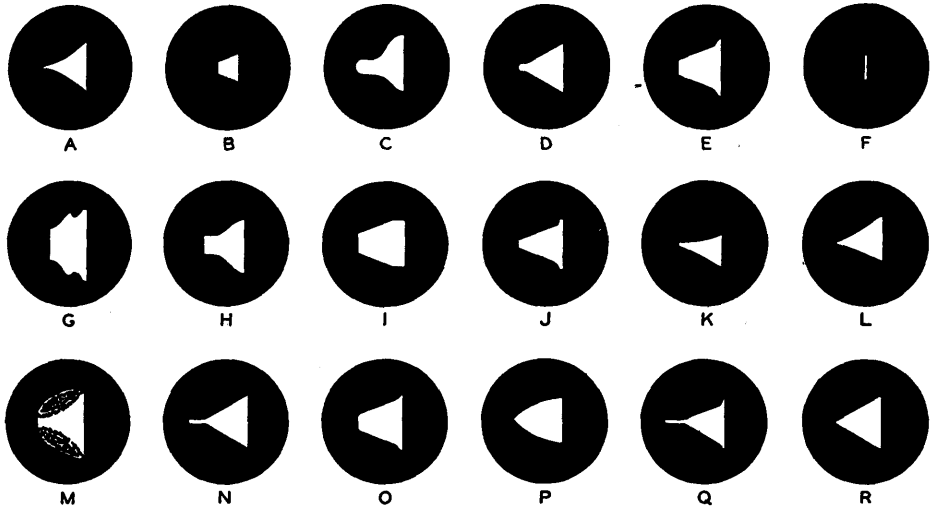

FIGURE 40. OSCILLOSCOPIC PATTERNS, PLATE AND GRID MODULATION.

- A: Plate-Modulated. Excessive Bias or Regeneration.
- B: Undistorted Plate or Grid Modulation. Less Than 100%.
- C: Suppressor-Modulated 802 or 814 Phone with Crystal in Grid Circuit.
- D: Suppressor-Modulated Phone with Separate R. F. Driver Tube, Modulated Approximately 100%.
- E: Maximum Plate Modulation of 6L6, 865 or 860 Screen-Grid Tubes without Screen Modulation (or Insufficient Screen Modulation).
- F: Unmodulated Carrier Signal.
- G: Plate-Modulated. Regeneration and Modulator Overload or Mismatch.
- H: Plate Overmodulation with Bad Mismatch of Class-B Modulator Impedance.
- I: Plate-Modulated. Insufficient R. F. Grid Drive to Allow Over 50% Modulation.
- J: Grid-Modulation. Excessive R. F. Grid Drive.
- K: Grid- or Plate-Modulated Phone with Improper Neutralization or Detuned Final Amplifier.
- L: 100% Grid Modulation. Normal Adjustments of $1\frac{1}{2}$ Times Cut-Off Bias. Curvature Due to High Bias.
- M: Phase Shift Through Speech Amplifier. Approximately 60% Modulation. No Distortion in Output.
- N: Plate or Grid Overmodulation. Too Much Audio Input.
- O: Class-B Mismatched or Underpowered. Corners or Pattern Indicate Overmodulation. May be due to Excessive Antenna Load for Transmitter.
- P: Insufficient R. F. Grid Drive with Plate Modulation.
- Q: Overmodulation. Too Much Audio Input (Audio Distortion) with Plate Modulation.
- R: 100% Modulation. Grid or Plate. No Distortion.

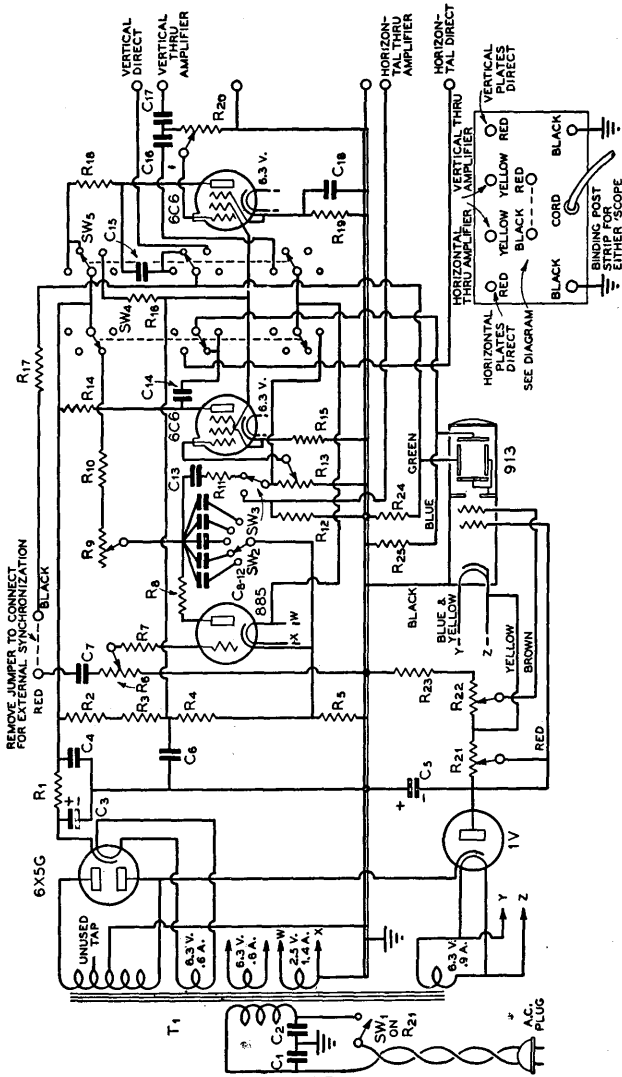

FIGURE 41. VERSATILE CATHODE RAY OSCILLOSCOPE INCORPORATING DEFLECTION PLATE AMPLIFIERS AND LINEAR SWEEP.

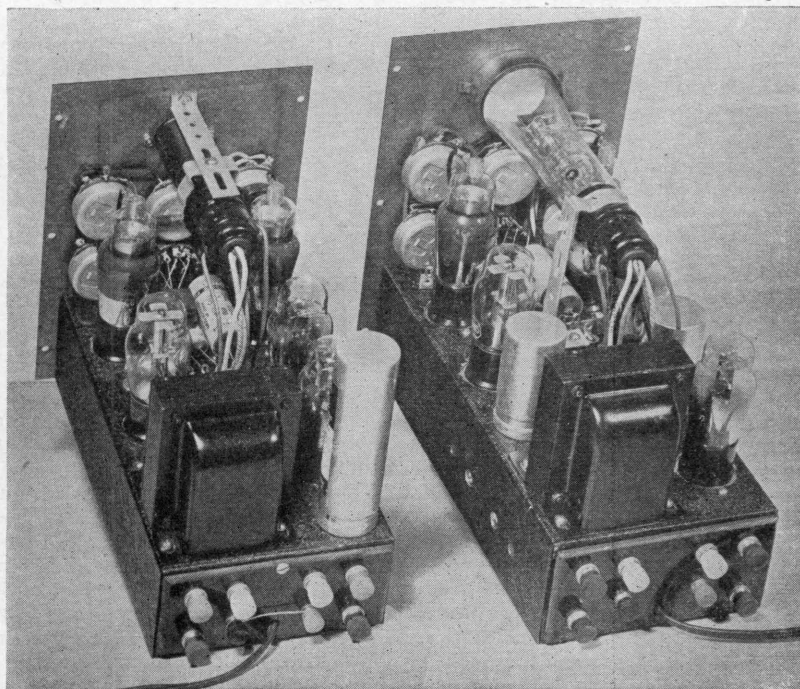

Figure 42. The oscilloscope to the left is a model of the one diagrammed in figure 41. The right-hand instrument is similar except that a 2-inch c.r. tube is used.

FIGURE 41. CONSTANTS OF THE VERSATILE CATHODE-RAY OSCILLOSCOPE.

R ₁ —5000 ohms, 1 watt	R ₂₀ —500,000-ohm potentiometer	C ₁₀ —0.02 μ fd., 400-volt tubular
R ₂ , R ₃ , R ₄ —40,000 ohms, 1 watt	R ₂₁ —25,000-ohm potentiometer with a.c. line switch	C ₁₁ —0.005- μ fd., mica
R ₅ —1500 ohms, 1/2 watt	R ₂₂ —50,000 ohm pot.	C ₁₂ —0.001- μ fd., mica
R ₆ —50,000-ohm potentiometer	R ₂₃ —150,000 ohms, 1 watt	C ₁₃ , C ₁₄ , C ₁₅ , C ₁₆ , C ₁₇ —0.1- μ fd., 400-volt tubulars
R ₇ —25,000 ohms, 1/2 watt	R ₂₄ —2 megohms, 1/2 watt	C ₁₈ —0.05- μ fd., 400-volt tubular
R ₈ —200 ohms, 1/2 watt	R ₂₅ —4 megohms, 1/2 watt	T ₁ —Cathode ray oscilloscope transformer
R ₉ —5-megohm potentiometer	C ₁ , C ₂ —0.1- μ fd., 400-volt tubular	SW ₁ —Line switch on R ₂₁
R ₁₀ —750,000 ohms, 1/2 watt	C ₃ , C ₄ , C ₅ —8- μ fd., 450-volt electrolytics	SW ₂ —5-position, single-pole switch
R ₁₁ , R ₁₂ —1 megohm, 1/2 watt	C ₆ —2- μ fd., 200-volt electrolytic	SW ₃ —S. p. d. t. toggle switch
R ₁₃ —3-megohm potentiometer	C ₇ —0.1- μ fd., 400-volt tubular	SW ₄ , SW ₅ —3-circuit 4-position, non-shorting switch
R ₁₄ —100,000 ohms, 1 watt	C ₈ —0.5- μ fd., 400-volt tubular	C.r. tube mounting—Amphenol 913 plug and bracket assembly
R ₁₅ —1000 ohms, 1/2 watt	C ₉ —0.1- μ fd., 400-volt tubular	
R ₁₆ —200,000 ohms, 1 watt		
R ₁₇ —2 megohms, 1/2 watt		
R ₁₈ —100,000 ohms, 1 watt		
R ₁₉ —1000 ohms, 1/2 watt		

CHAPTER 19

Radio Therapy

Treatment—Construction of Diathermy Machines— Rectifier Time Delays

RADIO-FREQUENCY energy can be applied to various parts of the human anatomy in order to produce a localized fever or temperature. The increase in temperature is effective for increasing circulation and for destroying certain kinds of germ diseases. The radio-frequencies involved in radio therapy normally range from 6 to 16 meters in wavelength, although there has not yet been an accepted standard of frequencies for the treatment of any particular ailment. The muscular cartilage, fatty and bone tissues all respond differently to applied radio waves. Some of these tissues are dielectrics while others are conductors, yet most of them have an intermediate characteristic, that of a leaky dielectric shunted by a capacitance. The radio energy is dissipated in the form of a dielectric loss which increases the temperature of that portion of the body under treatment. This form of treatment is known as *radio therapy*, and the apparatus used for administering the radio-frequency current is called a *diathermy machine*.

Treatment

The correct application of radio therapy depends upon the ailment and should, therefore, be under the supervision of a skilled physician. The diathermy machine usually has a means of controlling the power output and often has a frequency control in the form of plug-in coils. The radio energy is normally applied by means of a pair of rubber-covered metal electrodes which are placed on opposite sides of the portion of the body under treatment.

Radio therapy is used to kill certain

bacteria in the body, much in the same manner as artificially-induced typhoid fever. It must be emphasized that the ramifications of radio therapy are still highly problematical. The entire subject must be handled with discretion, because careless use of radio therapy can and has caused extremely serious damage. Self-treatment or the treatment of others by means of a home-built diathermy machine should never be attempted unless the operator is thoroughly familiar with this branch of physio-therapy.

Construction

A diathermy machine consists of an oscillator with a normal output of from 100 to 200 watts. The load impedance connected across the oscillator varies greatly; this requires special design of the oscillator circuit. The variation in load impedance is caused by the variation in size and in spacing between the electrodes required for various forms of treatment.

A circuit for an excellent diathermy machine is shown in figure 1. This circuit has certain features not found in most commercially-made machines. The oscillator circuit proper is a push-pull *Hartley* system in which the grid excitation is more constant than in most u.h.f. oscillator circuits for various load impedances. A full-wave rectifier system with sufficient filter capacity is needed to reduce radio interference caused by the more common form of self-rectified power supply circuit.

The waveform of the r.f. output power is less sharply peaked when a full-wave rectifying system is used, with the result that there is less danger to body

tissues. The ratio of peak-to-average r.f. voltage should be as low as possible in any diathermy machine. The only virtue of a self-rectified oscillator is its cheapness, and even though offered by many manufacturers, it should not be given consideration.

A 6E5 electron-ray tube is used as a "ready" indicator by having its 6.3-volt heater connected across the 5-volt filament supply. Its "active" elements are supplied with 150 to 200 volts of a.c. directly from the secondary of a midget a.f. output transformer, the primary winding of which is connected to the 110-v. input circuit. (See circuit diagram.) The 866 rectifier tubes should be allowed to reach normal temperature before the high voltage power supply switch is thrown to the *on* position. By the time the 6E5 tube first glows at full brilliancy, the 866's will have reached operating temperature and plate voltage may be applied.

Many of the older machines, and some of the newer ones as well, do not use either a lumped or adjustable capacity across the output tank coil; the tank circuit therefore has insufficient Q, especially when a single-ended oscillator is

used. The well-designed diathermy machine uses a pair of fixed condenser plates which act as a lumped capacity across the plate tank circuit. The pads are tuned to resonance by means of a variable condenser in the output circuit.

The system shown in the schematic diagram has many advantages over the aforementioned types in that the *oscillator* is tuned to the *output circuit*, instead of the pads being tuned to the frequency of the oscillator. When the plates of the tank condenser in figure 1 are entirely *out*, the "minimum" capacity of the condenser is high enough to offer sufficient Q for proper operation of a push-pull circuit below 16 meters; at the same time, it allows a frequency range of almost two-to-one to be covered merely by using pads that resonate at different frequencies.

If a still greater frequency range is to be covered, this can be accomplished by means of plug-in coils. A five-connection jack and plug transmitter assembly is suitable for use with such coils, and by this means it will then be possible to cover a range of from approximately 5 to 19 meters. Pads with long leads sometimes can be resonated after a *fash-*

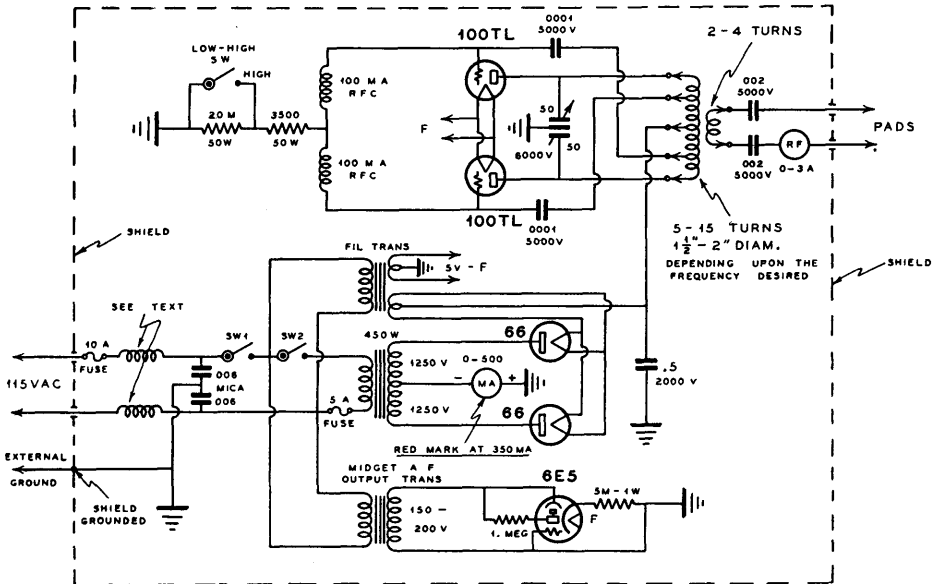

FIGURE 1. VARIABLE-HIGH-FREQUENCY DIATHERMY MACHINE CAPABLE OF DELIVERING 250-WATTS OUTPUT.

ion at the higher frequencies (5 or 6 meters) by resonating them on the third harmonic.

The disadvantage of the customary fixed-tuned plate tank and series-tuned pad circuit lies in the high capacity series variable condenser which is required; also, it is often difficult to resonate the pads when they are placed in some unusual position on the body of the patient. In addition to its high capacity, the series condenser must have wider plate spacing than would ordinarily be assumed, because the pads will sometimes resonate when the condenser plates are almost entirely unmeshed. Under the latter condition, there is a high r.f. potential across the condenser.

The r.f. potential in a condenser which is placed across a plate tank is much more uniform under the varying conditions encountered with the pad circuit. In addition, the capacity of the condenser need be only a fraction of that ordinarily required where the condenser is used to resonate the pad circuit.

All insulation that is either in contact with r.f. leads or in an r.f. field should be of high-grade ceramic material. The tank and antenna coils can be wound with no. 8 wire, self-supported by end and center-tap connections.

A push-pull *Hartley* circuit is used in the machine described because its frequency can be varied by a single tuning condenser without affecting the excitation. In addition to being superior in this respect, the circuit performs equally well in all other respects; then, too, if plug-in coils are used, it is only necessary to change a single coil.

An approximate adjustment of the output is secured by means of a *high-low* switch. The output decreases considerably when the switch is opened, thereby adding a 20,000-ohm grid leak into the circuit. Minute adjustment of the output is obtained by simply detuning the tank condenser, a crude but entirely satisfactory method. This means that the operator need manipulate only one switch and one knob for output adjustment.

At the point where the 110-volt a.c. supply leads enter the cabinet housing the diathermy machine, 20 turns of no. 12 wire are wound on a diameter of $\frac{3}{4}$ inch and connected in series with the transformer primaries and the two a.c. supply leads. These coils constitute an

effective pair of line chokes, one in each lead of the 110-volt line. They are as effective as any commercially-made choke, the latter normally being designed to operate at lower frequencies than those at which the diathermy machine operates. These homemade u.h.f. chokes, in connection with the .006- μ fd. condensers shown in the circuit diagram, constitute as effective a filter as it is possible to secure.

The grid taps on each tank coil are made exactly the same distance from each side of center. If one tube heats more than the other, the taps are not made symmetrically. To adjust the taps to their proper position, disconnect the pads from the circuit, place a 0-150 or 0-250 ma. a.c. milliammeter across the 20,000-ohm grid leak with the *high-low* switch in the *low* (open) position, and move the taps outwardly toward the ends of the coil until the meter gives an indication of 100 ma. This is greater than the maximum grid current rating of the tubes (35 ma. per tube), but with the pads connected to the circuit this value will decrease slightly, and when the pads are loaded (resonated) there will be another decrease. Normally, the grid current will be somewhat less than 70 ma. for the two tubes. When the grid meter is removed, and with the switch in the *low* position (with the additional grid leak in the circuit) the grid current will be still lower.

A grid meter can be permanently incorporated in this diathermy machine, if desired, in which event it would be wired in *series* with the grid resistor. It is absolutely necessary, however, only for this initial adjustment.

A red ink "warning" marker should be drawn on the scale of the plate meter at the point of 350 ma., to make certain that this value of plate current will not be exceeded. The plate meter is the only essential meter in the machine, although some physicians insist upon an r.f. meter in the pad circuit. Neither plate current nor r.f. output are more than an approximate index of the degree of heating; they are not relied upon except as a relative check when the pads are in any *given position* on a *certain patient*. When the pads are placed in different positions, the r.f. meter may read either higher or lower for a given heating effect. The actual temperature of that portion of the patient's body under treat-

ment is the only safe barometer of the amount of heating effect being supplied.

The mica condensers in series with the pads have no effect on the performance of the circuit; they are used merely to safeguard the patient against high d.c. voltages in the event of breakdown of the ceramic coil supports.

It is very difficult to stop oscillation by means of excessive output loading; nothing other than an abnormal value of plate current will result when the machine is too heavily loaded, as will be indicated when the meter needle passes the red "danger" mark. Should the circuit accidentally stop oscillating, excessive plate current will flow just long enough to blow the 5-ampere primary fuse. For this reason, the fuses should be readily accessible from the outside of the machine.

It is important that the center-tap connection, rather than one leg, of the rectifier filament winding be used for the high voltage connection. This prevents r.f. from finding its way back into the tubes through the high voltage lead, because the capacity of the transformer to ground is sufficiently high to by-pass practically all r.f. to ground. The r.f. current in the high voltage lead is very small (theoretically zero at the fundamental frequency), but is sufficient to cause erratic operation of the rectifiers if this current finds its way back into them. The 0.5- μ fd. filter condenser is not very effective at radio frequencies and it is, therefore, possible to draw small sparks from the high voltage lead.

The small filter condenser (0.5 μ fd.) provides sufficient filtration to prevent the oscillator tubes from going out of oscillation instantaneously 120 times per second. "Hash" on the lower frequencies, including the broadcast band will result from such momentary cessation of oscillation. The ripple voltage will still be quite high, with the small filter, but interference on frequencies other than the operating frequency will be eliminated.

It is not advisable to use higher capacity values than those shown in figure 1; otherwise the plate voltage will rise to excessive values when the pads are not loaded and when the plate current is relatively low. This, in turn, results in excessive grid current. The grid current normally tends to rise badly anyway when an oscillator is not loaded.

Radio Interference

Diathermy machines are essentially radio transmitters, and they can cause serious interference to radio reception. The diathermy machine should be housed in a shielded cabinet; the 110-volt line should include an r.f. filter in order to prevent the r.f. energy from being fed back into the line and thereby being radiated into space. The output electrode pads and the patient act as an antenna system, therefore both machine and patient should be placed in a metal-screened room. This room can be made of ordinary galvanized iron screen, provided that all seams are carefully soldered and especial care taken to prevent r.f. leakage around the doorway. This type of room construction is similar to that used for receiver testing in radio manufacturing plants.

If this diathermy machine causes interference to nearby amateurs on the 5-, 10- and 20-meter bands, the cure lies in the installation of a heavy duty *choke-input filter*, consisting of a 30-henry 350-ma. swinging choke and a 4- μ fd. 2,000-volt condenser. This permits a high degree of filtering without sacrificing voltage regulation. The interference will then be confined to a very narrow range of frequencies. If a choke input filter is used, a higher voltage plate transformer will be required (1500 v.).

Rectifier Time Delay

In order to prolong the life of rectifier and oscillator tubes, it is important that they be permitted to warm up for a period of 20 or 30 seconds before plate voltage is applied. Switch SW₂ should never be thrown to the *on* position, until switch SW₁ has first been turned on. This means that switch SW₂ is turned on last, and turned off first. The 6E5 electron-ray indicator tube can be mounted directly above switch SW₂ with the following inscribed on the panel: SW₂ *Should Never Be Turned ON Except When Green Light Shows*. This rule will make it necessary for the user to wait for about thirty seconds before the plate voltage is turned on. SW₂, however, must always be turned *off* before SW₁ is turned *on*; otherwise SW₂ will remain *on* when the electron-ray indicator light is not glowing.

To avoid this possibility the following

should also be inscribed conspicuously on the control panel: *When Through with Machine, Be Sure All Switches Are Turned Off.* A red pilot light connected across the primary of one of the filament transformers will help the physician to remember to turn off switch SW₁.

If desired, a time delay relay may be used to protect the rectifiers, thus making a fool-proof arrangement. However, besides being cheaper, the 6E5 indicator enhances the machine and impresses the patient. This last factor has been stressed by most physicians ordering this type of equipment, and cannot be ignored.

Heating Pads

Information as to the availability of the heating pads may be obtained by referring to the catalog section of this book.

A DE LUXE MODEL

The diathermy machine illustrated in the accompanying photos is a de luxe model, having all worthwhile refinements and capable of delivering more than sufficient power for all purposes to which such machines are put. Several safety devices have been incorporated in the machine in order to make it as foolproof as possible. All components have a large safety factor, thus reducing the chance for failure of any part even

when the machine is used continuously for long periods of time.

Two HF-200's are used in a push-pull Armstrong circuit having an untuned grid coil, commonly called a "TNT" circuit. The wavelength utilized is the same as that used by most of the modern machines, approximately 7 meters. Many of these machines are advertised as 5- or 6-meter machines, but most of them actually work on 7 or 8 meters.

The unit is constructed in a double deck steel cabinet which is mounted on swivel type rubber-tired wheels. A narrow meter panel is placed above the r.f. panel as may be seen in the illustration of the complete unit. The power supply is mounted at the bottom because of its weight.

Fine adjustment of the output is obtained by means of a tuned output circuit, adjustable from the front panel. To conserve the tubes when but little output is required, "Lo-Hi" switch is incorporated. On the "high" position, approximately 2000 volts is applied to the tubes. On the "low" position, the 110-volt primary leads to the plate transformer are switched to the 220-volt taps on the transformer, cutting the plate voltage in half. Additional grid leak is cut into the circuit when the switch is thrown to the low position, further reducing the output slightly. This switch is used for coarse adjustment of the output, the tuning control for fine adjustment. This switch is actually three standard type toggle

FIGURE 2. R.F. UNIT OF THE DE LUXE DIATHERMY.

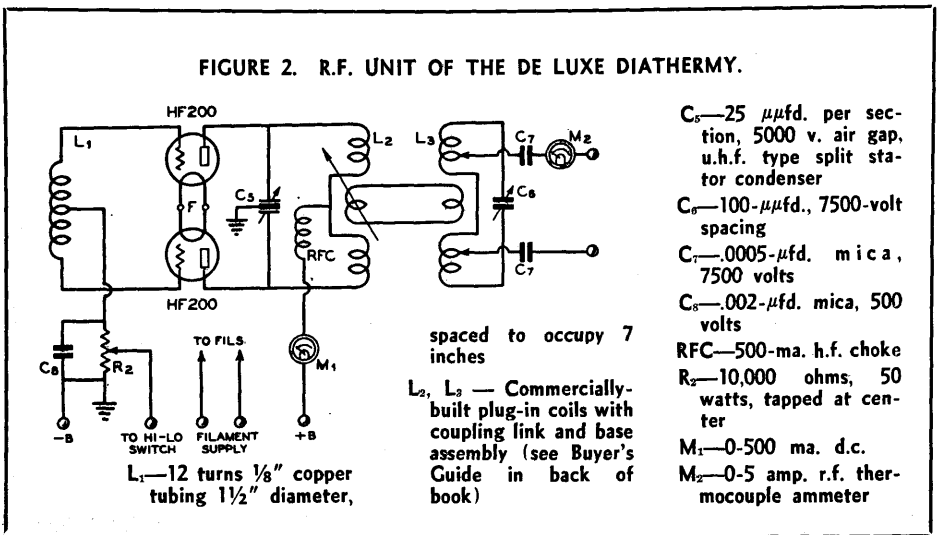

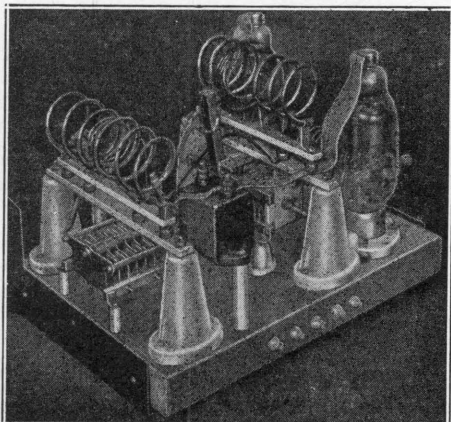

Figure 3. R.f. section of the HF-200 diathermy. The grid coil is behind the tubes, the plate tank with its fixed-tune variable condenser directly in front of them, and the output coupler to the left. The condenser tuning the coupling coil, seen directly below the coil to the extreme left, is driven from the front panel by means of a flexible shaft.

switches, ganged together by means of a holder made for the purpose. Three small toggle switches are used in a similar arrangement for the line switch, paralleled to provide sufficient current carrying capacity.

The output circuit is not only tuned, but is provided with adjustable coupling. This permits the coupling to be loosened until at no time the tuning of the pads throws the unit out of oscillation. The coupling is then left permanently in this position. The condenser C_6 , which tunes the output circuit, is the only control on the front panel other than the switches. It is driven by means of a flexible shaft.

The plate tank condenser C_5 is tuned to resonance from the back of the cabinet when the machine is first put in operation. It is then left permanently in this position. When this condenser has been properly adjusted, it will be possible to load the oscillator quite heavily without its going out of oscillation.

The applicator pads are a standard item, available from most medical supply houses. The output circuit utilized allows for satisfactory operation with most standard cord lengths regardless of where the pads are placed on the patient. Hence, in ordering the pads, it is not necessary to specify any particular length pad cords, so long as the pads and cords are designed for use with 5- to 15-

meter machines. The blocking condensers C_7 are merely a safety precaution.

To protect the tubes, meter and plate transformer should the oscillator go out of resonance due to excessive loading, an overload relay is incorporated. In order to trip properly when the machine is used on "Low" and goes out of oscillation, a 250-ma. relay is used. As the machine will sometimes draw more than this amount of current under normal conditions when used at full plate voltage, the relay is shunted by a suitable resistor to increase its capacity when the machine is run at full power. The "Lo-Hi" switch does this automatically.

To make the machine foolproof, a door switch, time delay relay and time switch are used. The door switch shuts off the power supply when the cabinet door is opened. The time delay relay permits the 866's to reach operating temperature before allowing plate voltage to be applied, leaving nothing to chance. The time switch, directly below the tuning control, is similar to that used on electric stoves, and allows the doctor to preset the machine for any length treatment up to 30 minutes.



Figure 4. This de luxe 400-watt u.h.f. diathermy machine incorporates many safety features and worthwhile refinements. It uses two HF-200's in a push-pull Armstrong circuit.

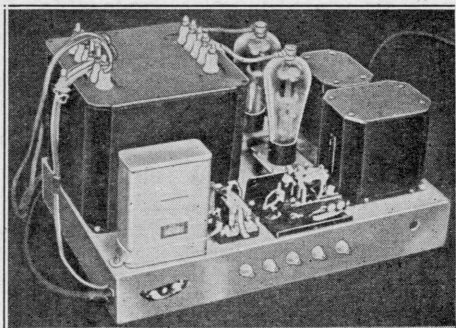

Figure 5. Power supply deck for the 400-watt diathermy, rear view. The relay in left foreground is the overload relay, that to the right the time delay relay (covers removed for picture). T_1 and CH are mounted below the chassis.

Two meters are provided, a plate milliammeter and an r.f. ammeter, the latter indicating the amount of circulating current in the pad circuit. Isolantite and

Mycalex insulation are used throughout. Both the plate coil and the output coupler coil are standard, commercially-built plug-in coils. The grid coil is wound of eighth-inch copper tubing and held rigid by a Mycalex strip.

Enclosing the entire machine in the steel cabinet minimizes the interference created in nearby radio receivers. To reduce this interference still further, the power supply contains a filter which smooths the rectified a.c. into nearly pure d.c. For the sake of economy, the filter is of the resonant type, and is very effective when the right values of inductance and capacity are used. The combination CH- C_4 must resonate at the ripple frequency, and C_4 will depend upon the actual choke used. Any small filter choke will do, so long as it hasn't too much inductance and the insulation is good. The best value for C_4 should be determined by cut and try; it will be between 1 and 6 μ fd.

FIGURE 6. POWER SUPPLY UNIT OF THE DE LUXE DIATHERMY.

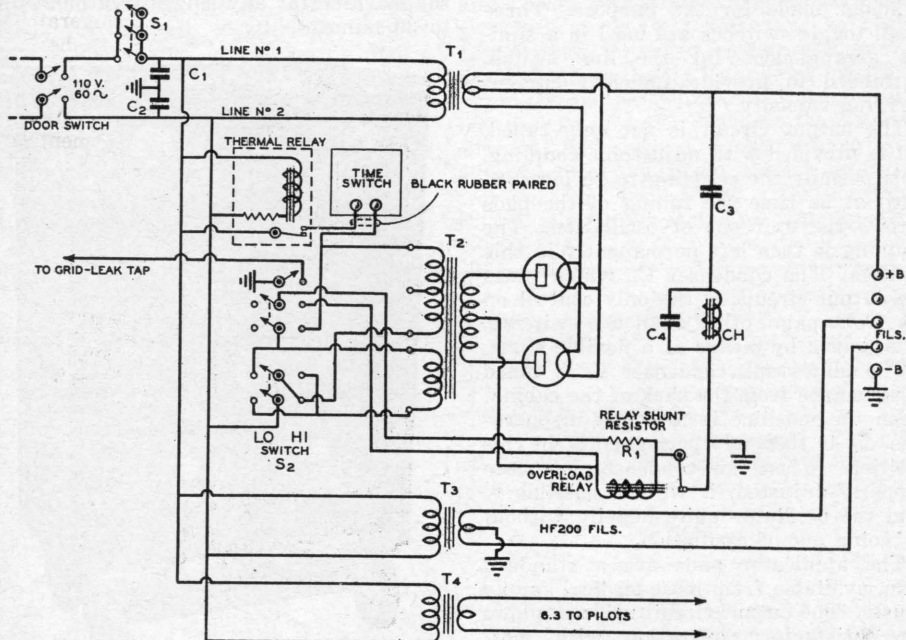

C_1, C_2 —0.1- μ fd. paper, 400 v.

C_3 —2- μ fd. oil condenser, 2500 v.

C_4 —Between 1 and 6

μ fd., 600 volts (see text)

R_1 —25 ohms, adjustable, 25 watts (adjusted to approx. 16 ohm)

T_1 —2.5 v. 10 amps, 5000-v. insulation
 T_2 —1750 v. each side c.t., 500 ma., with both 110 and 220 v. primary

T_3 —11 volts, 10 amps.

T_4 —6.3 v. at 1.2 amps.
 CH—Filter choke (see text)

Chapter 20

Radio Laws

The following excerpts from the Federal Communications Commission's rules include all that deal solely with the amateur service and certain others that apply generally.

Effective December 1, 1938

DEFINITIONS

Sec. 150.01 **Amateur service.** The term "amateur service" means a radio service carried on by amateur stations.

Sec. 150.02 **Amateur station.** The term "amateur station" means a station used by an "amateur," that is, a duly authorized person interested in radio technique solely with a personal aim and without pecuniary interest. It embraces all radio transmitting apparatus at a particular location used for amateur service and operated under a single instrument of authorization.

Sec. 150.03 **Amateur portable station.** The term "amateur portable station" means an amateur station that is portable in fact, that is so constructed that it may conveniently be moved about from place to place for communication, and that is in fact so moved from time to time, but which is not operated while in motion.

Sec. 150.04 **Amateur portable-mobile station.** The term "amateur portable-mobile station" means an amateur station that is portable in fact, that is so constructed that it may conveniently be transferred to or from a mobile unit or from one such unit to another, and that is in fact so transferred from time to time and is ordinarily used while such mobile unit is in motion.

Sec. 150.05 **Amateur radio communication.** The term "amateur radio communication" means radio communication between amateur stations solely with a personal aim and without pecuniary interest.

Sec. 150.06 **Amateur operator.** The term "amateur operator" means a person holding a valid license issued by the Federal Communications Commission authorizing him to operate licensed amateur stations.

AMATEUR OPERATORS

LICENSES; PRIVILEGES

Sec. 151.01 **Eligibility for license.** The following are eligible to apply for amateur operator license and privileges:

Class A—A United States citizen who has within five years of receipt of application held license as an amateur operator for a year or who in lieu thereof qualified under Section 151.20.

Class B—Any United States citizen.

Class C—A United States citizen whose actual residence, address, and station, are more than 125 miles airline from the nearest point where examination is given at least quarterly for Class B; or is shown by physician's certificate to be unable to appear for examination due to protracted disability; or is shown by certificate of the commanding officer to be in a camp of the Civilian Conservation Corps or in the regular military or naval service of the United States at a military post or naval station

and unable to appear for Class B examination.

Sec. 151.02 **Classification of operating privileges.** Amateur operating privileges are as follows:

Class A—All amateur privileges.

Class B—Same as Class A except specially limited as in Section 152.28

Class C—Same as Class B.

Sec. 151.03 **Scope of operator authority.** Amateur operators' licenses are valid only for the operation of licensed amateur stations; provided, however, any person holding a valid radio operator's license of any class may operate stations in the experimental service licensed for, and operating on, frequencies above 300,000 kilocycles.

Sec. 151.04 **Posting of license.** The original operator's license shall be posted in a conspicuous place in the room occupied by such operator while on duty or kept in his personal possession and available for inspection at all times while the operator is on duty, except when such license has been filed with application for modification or renewal, or has been mutilated, lost, or

destroyed, and application has been made for a duplicate.

Sec. 151.05 Duplicate license. Any licensee applying for a duplicate license to replace an original which has been lost, mutilated, or destroyed, shall submit to the Commission such mutilated license or affidavit attesting to the facts regarding the manner in which the original was lost or destroyed. If the original is later found, it or the duplicate shall be returned to the Commission.

Sec. 151.06 Renewal of amateur operator license. An amateur operator license may be renewed upon proper application and a showing that within three months of receipt of the application by the Commission the licensee has lawfully operated an amateur station licensed by the Com-

mission, and, that he has communicated by radio with at least three other such amateur stations. Failure to meet the requirements of this section will make it necessary for the applicant to again qualify by examination.

Sec. 151.07 Who may operate an amateur station. An amateur station may be operated only by a person holding a valid amateur operator's license, and then only to the extent provided for by the class of privileges for which the operator's license is endorsed. When an amateur station uses radiotelephony (type A-3 emission) the licensee may permit any person to transmit by voice, provided a duly licensed amateur operator maintains control over the emissions by turning the carrier on and off when required and signs the station off after the transmission has been completed.

EXAMINATIONS

Sec. 151.15 When required. Examination is required for a new license as an amateur operator or for change of class of privileges.

Sec. 151.16 Elements of examination. The examination for amateur operator privileges will comprise the following elements:

1. Code test—ability to send and receive, in plain language, messages in the International Morse Code at a speed of not less than thirteen words per minute, counting five characters to the word, each numeral or punctuation mark counting as two characters.
2. Amateur radio operation and apparatus, both telephone and telegraph.
3. Provisions of treaty, statute and regulations affecting amateurs.
4. Advanced amateur radiotelephony.

Sec. 151.17 Elements required for various privileges. Examinations for Class A privileges will include all four examination elements as specified in Section 151.16.

Examinations for Class B and C privileges will include elements 1, 2, and 3 as set forth in Section 151.16.

Sec. 151.18 Manner of conducting examination. Examinations for Class A and Class B privileges will be conducted by an authorized Commission employee or representative at points specified by the Commission.

Examinations for Class C privileges will be given by volunteer examiner(s), whom the Commission may designate or permit the applicant to select; in the latter event the examiner giving the code test shall be a holder of an amateur license with Class A or B privileges, or have held within five years a license as a professional radiotelegraph operator or have within that time been employed as a radiotelegraph operator in the service of the United States; and the examiner for the written test, if not the same individual, shall be a person of legal age.

Sec. 151.19 Additional examination for holders of Class C privileges. The Commission may require a licensee holding Class C privileges to appear at an examining point for a Class B examination. If such licensee fails to appear for examination when directed to do so, or fails to pass the supervisory examination, the license held will be canceled and the holder thereof will not be issued another license for the Class C privileges.

Whenever the holder of Class C amateur operator privileges changes his actual residence or station location to a point where he would not

be eligible to apply for Class C privileges in the first instance, or whenever a new examining point is established in a region from which applicants were previously eligible for Class C privileges, such holders of Class C privileges shall within four months thereafter appear at an examining point and be examined for Class B privileges. The license will be canceled if such licensee fails to appear, or fails to pass the examination.

Sec. 151.20 Examination abridgment. An applicant for Class A privileges, who holds a license with Class B privileges, will be required to pass only the added examination element No. 4 (see Section 151.16).

A holder of Class C privileges will not be accorded an abridged examination for either Class B or Class A privileges.

An applicant who has held a license for the class of privileges specified below, within five years prior to receipt of application, will be credited with examination elements as follows:

Class of license or privileges	: Credits
Commercial extra first	: Elements 1, 2 & 4
Radiotelegraph 1st, 2nd, or 3rd	: Elements 1 & 2
Radiotelephone 1st or 2nd	: Elements 2 & 4
Class A	: Elements 2 & 4

No examination credit is given on account of license of Radiotelephone 3rd Class, nor for other class of license or privileges not above listed.

Sec. 151.21 Examination procedure. Applicants shall write examinations in longhand,—code tests and diagrams in ink or pencil, written tests in ink—except that applicants unable to do so because of physical disability may typewrite or dictate their examinations and, if unable to draw required diagrams, may make instead a detailed description essentially equivalent. The examiner shall certify the nature of the applicant's disability and, if the examination is dictated, the name and address of the person(s) taking and transcribing the applicant's dictation.

Sec. 151.22 Grading. Code tests are graded as passed or failed, separately for sending and receiving tests. A code test is failed unless free of omission or other error for a continuous period of at least one minute at required speed. Failure to pass the required code test will terminate the examination. (See Sec. 151.23).

A passing grade of 75 per cent is required separately for Class B and Class A written examinations.

Sec. 151.23 Eligibility for reexamination. An applicant who fails examination for amateur

privileges may not take another examination for such privileges within two months, except that

this rule shall not apply to an examination for Class B following one for Class C.

AMATEUR RADIO STATIONS

LICENSES

Sec. 152.01 Eligibility for amateur station license. License for an amateur station will be issued only to a licensed amateur operator who has made a satisfactory showing of control of proper transmitting apparatus and control of the premises upon which such apparatus is to be located; provided, however, that in the case of an amateur station of the military or Naval Reserve of the United States located in approved public quarters and established for training purposes, but not operated by the United States Government, a station license may be issued to a person in charge of such a station although not a licensed amateur operator.

Sec. 152.02 Eligibility of corporations or organizations to hold license. An amateur station license will not be issued to a school, company, corporation, association, or other organization; nor for their use; provided, however, that in the case of a bona fide amateur radio society a station license may be issued in accordance with Section 152.01 to a licensed amateur operator as trustee for such society.

Sec. 152.03 Location of station. An amateur radio station, and the control point thereof when remote control is authorized, shall not be located on premises controlled by an alien.

Sec. 152.04 License period. License for an amateur station will normally be for a period of three years from the date of issuance of a new, renewed, or modified license.

Sec. 152.05 Authorized operation. An amateur station license authorizes the operation of all transmitting apparatus used by the licensee at the location specified in the station license and in addition the operation of portable and portable-mobile stations at other locations under the same instrument of authorization.

Sec. 152.06 Renewal of amateur station license. An amateur station license may be renewed upon proper application and a showing that, within three months of receipt of the application by the Commission, the licensee thereof has lawfully operated such station in communication by radio with at least three other amateur stations licensed by the Commission, except that in the case of an application for renewal of station license issued for an amateur society or reserve group, the required operation may be by any licensed amateur operator. Upon failure to comply with the above requirements, a successor license will not be granted until two months after expiration of the old license.

Sec. 152.07 Posting of station license. The original of each station license or a facsimile thereof shall be posted by the licensee in a conspicuous place in the room in which the transmitter is located or kept in the personal possession of the operator on duty, except when such license has been filed with application for modification or renewal, or has been mutilated, lost, or destroyed, and application has been made for a duplicate.

CALL SIGNALS

Sec. 152.08 Assignment of call letters. Amateur station calls will be assigned in regular order and special requests will not be considered except that a call may be reassigned to the latest holder, or if not under license during the past five years to any previous holder or to an amateur organization in memoriam to a deceased member and former holder, and particular calls may be temporarily assigned to stations connected with events of general public interest.

Sec. 152.09 Call signals for member of U.S.N.R. In the case of an amateur licensee whose station is licensed to a regularly commissioned or enlisted member of the United States Naval Reserve, the Commandant of the naval district in which such station is located may authorize in his discretion the use of the call-letter prefix N in lieu of the prefix W or K, assigned in the license issued by the Commission, provided that such N prefix shall be used only when operating in the frequency bands 1715-2000¹ kilocycles, 3500-4000 kilocycles, 56,000-60,000 kilocycles, and 400,000-401,000 kilocycles in accordance with instructions to be issued by the Navy Department.

Sec. 152.10 Transmission of call signals. An operator of an amateur station shall transmit its assigned call at the end of each transmission and

at least once every ten minutes during transmission of more than ten minutes' duration; provided, however, that transmission of less than one minute duration from stations employing break-in operation need be identified only once every ten minutes of operation and at the termination of the correspondence. In addition, an operator of an amateur portable or portable-mobile radiotelegraph station shall transmit immediately after the call of the station the fraction-bar character (DN) followed by the number of the amateur call area in which the portable or portable-mobile amateur station is then operating, as for example:

Example 1. Portable or portable-mobile amateur station operating in the third amateur call area calls a fixed amateur station: W1ABC W1ABC W1ABC DE W2DEF DN3 W2DEF DN3 W2DEF DN3 AR.

Example 2. Fixed amateur station answers the portable or portable-mobile amateur station: W2DEF W2DEF W2DEF DE W1ABC W1ABC W1ABC K.

Example 3. Portable or portable-mobile amateur station calls a portable or portable-mobile amateur station: W3GHI W3GHI W3GHI DE W4JKL DN4 W4JKL DN4 W4JKL DN4 AR.

If telephony is used, the call sign of the station shall be followed by an announcement of the

¹ Subject to change to "1750 to 2050" kilocycles in accordance with the "Inter-American Arrangement Covering Radiocommunication", Havana, 1937.

amateur call area in which the portable or portable-mobile station is operating.

Sec. 152.11 Requirements for portable and portable-mobile operation. A licensee of an amateur station may operate portable amateur stations (Section 150.03) in accordance with the provisions of Sections 152.09, 152.10, 152.12 and 152.45. Such licensee may operate portable and portable-mobile amateur stations without regard to Section 152.12, but in compliance with Sections 152.09, 152.10, and 152.45, when such operation takes place on authorized amateur frequencies above 28,000 kilocycles.

Sec. 152.12 Special provisions for portable stations. Advance notice in writing shall be given by the licensee to the inspector in charge of the district in which such portable station is to be operated. Such notices shall be given prior to any operation contemplated, and shall state the station call, name of licensee, the date of proposed operation, and the locations as specifically as possible. An amateur station operating under this Section shall not be operated during any period exceeding one month without giving further notice to the inspector in charge of the

radio-inspection district in which the station will be operated, nor more than four consecutive periods of one month at the same location. This Section does not apply to the operation of portable or portable-mobile amateur stations on frequencies above 28,000 kilocycles. (See Section 152.11).

Sec. 152.13 Special provisions for non-portable stations. The provisions for portable stations shall not be applied to any non-portable station except that:

a. An amateur station that has been moved from one permanent location to another permanent location may be operated at the latter location in accordance with the provisions governing portable stations for a period not exceeding sixty days, but in no event beyond the expiration date of the license, provided an application for modification of license to change the permanent location has been made to the Commission.

b. The licensee of an amateur station who is temporarily residing at a location other than the licensed location for a period not exceeding four months may for such period operate his amateur station at his temporary address in accordance with the provisions governing portable stations.

USE OF AMATEUR STATIONS

Sec. 152.14 Points of communication. An amateur station shall communicate only with other amateur stations, except that in emergencies or for testing purposes it may be used also for communication with commercial or Government radio stations. In addition, amateur stations may communicate with any mobile radio station which is licensed by the Commission to communicate with amateur stations, and with stations of expeditions which may also be authorized to communicate with amateur stations. They may also make transmissions to points equipped only with receiving apparatus for the measurement of emissions, observation of transmission phenomena, radio control of remote objects, and similar purely experimental purposes.

Sec. 152.15 No remuneration for use of station.

An amateur station shall not be used to transmit or receive messages for hire, nor for communication for material compensation, direct or indirect, paid or promised.

Sec. 152.16 Broadcasting prohibited. An amateur station shall not be used for broadcasting any form of entertainment, nor for the simultaneous retransmission by automatic means of programs or signals emanating from any class of station other than amateur.

Sec. 152.17 Radiotelephone tests. The transmission of music by an amateur station is forbidden. However, single audio-frequency tones may be transmitted by radiotelephony for test purposes of short duration in connection with the development of experimental radiotelephone equipment.

ALLOCATION OF FREQUENCIES

Sec. 152.25 Frequencies for exclusive use of amateur stations. The following bands of frequencies are allocated exclusively for use by amateur stations:

1715 to 2000 kilocycles ¹	28000 to 30000 kilocycles
3500 to 4000 kilocycles	56000 to 60000 kilocycles
7000 to 7300 kilocycles	112000 to 118000 kilocycles ²
14000 to 14400 kilocycles	224000 to 230000 kilocycles ²
	400000 to 401000 kilocycles

Sec. 152.26 Use of frequencies above 300000 kilocycles. The licensee of an amateur station may, subject to change upon further order, operate amateur stations, with any type of emission authorized for amateur stations, on any frequency above 300000 kilocycles without separate licenses therefor.

Sec. 152.27 Frequency bands for telephony. The following bands of frequencies are allocated for use by amateur stations using radiotelephony, type A-3 emission:

1800 to 2000 kilocycles	112000 to 118000 kilocycles ²
28500 to 30000 kilocycles	224000 to 230000 kilocycles ²
56000 to 60000 kilocycles	400000 to 401000 kilocycles

Sec. 152.28 Additional bands for telephony. An amateur station may use radiotelephony, type A-3 emission, in the following additional bands of frequencies; provided the station is licensed to a person who holds an amateur operator's license endorsed for Class A privileges, and actually is operated by an amateur operator holding Class A privileges:

3900 to 4000 kilocycles	14150 to 14250 kilocycles
-------------------------	---------------------------

Sec. 152.29 Television and frequency-modulation transmission. The following bands of frequencies are allocated for use by amateur station for television and radiotelephone frequency-modulation transmission:

112000 to 118000 kilocycles ²
224000 to 230000 kilocycles ²
400000 to 401000 kilocycles

Sec. 152.30 Facsimile transmission. The following bands of frequencies are allocated for use by amateur stations for facsimile transmission:

1715 to 2000 kilocycles ¹	112000 to 118000 kilocycles ²
--------------------------------------	--

² The Commission reserves the right to change or cancel these frequencies without advance notice or hearing.

56000 to 60000 kilocycles 224000 to 230000 kilocycles²
400,000 to 401000 kilocycles

Sec. 152.31 **Individual frequency not specified.** Transmissions by an amateur station may be on any frequency within the bands above assigned. Sideband frequencies resulting from keying or modulating a transmitter shall be confined within the frequency band used.

Sec. 152.32 **Types of emission.** All bands of frequencies allocated to the amateur service may be used for radiotelegraphy, type A-1 emission. Type A-2 emission may be used in the following bands of frequencies only:

56000 to 60000 kilocycles
112000 to 118000 kilocycles²
224000 to 230000 kilocycles²
400000 to 401000 kilocycles

EQUIPMENT AND OPERATION

Sec. 152.40 **Maximum power input.** The licensee of an amateur station is authorized to use a maximum power input of 1 kilowatt to the plate circuit of the final amplifier stage of an oscillator-amplifier transmitter or to the plate circuit of an oscillator transmitter. An amateur transmitter operating with a power input exceeding nine-hundred watts to the plate circuit shall provide means for accurately measuring the plate power input to the vacuum tube, or tubes, supplying power to the antenna.

Sec. 152.41 **Power supply to transmitter.** The licensee of an amateur station using frequencies below 60000 kilocycles shall use adequately filtered direct-current plate power supply for the transmitting equipment to minimize frequency modulation and to prevent the emission of broad signals.

Sec. 152.42 **Requirements for prevention of interference.** Spurious radiations from an amateur transmitter operating on a frequency below 60000 kilocycles shall be reduced or eliminated in accordance with good engineering practice and shall not be of sufficient intensity to cause interference on receiving sets of modern design which are tuned outside the frequency band of emission normally required for the type of emission employed. In the case of A-3 emission, the transmitter shall not be modulated in excess of its modulation capability to the extent that interfering spurious radiations occur, and in no case shall the emitted carrier be amplitude-modulated in excess of 100 per cent. Means shall be employed to insure that the transmitter is not modulated in excess of its modulation capability. A spurious radiation is any radiation from a transmitter which is outside the frequency band of emission normal for the type of transmission employed, including any component whose frequency is an integral multiple or submultiple of the carrier frequency (harmonics and subharmonics), spurious modulation products, key clicks, and other transient effects, and parasitic oscillations. The frequency of emission shall be as constant as the state of the art permits.

Sec. 152.43 **Modulation of carrier wave.** Except for brief tests or adjustments, an amateur radiotelephone station shall not emit a carrier wave unless modulated for the purpose of communication.

Sec. 152.44 **Frequency measurement and regular check.** The licensee of an amateur station shall provide for measurement of the transmitter frequency and establish procedure for checking it regularly. The measurement of the transmitter frequency shall be made by means independent of the frequency control of the transmitter and

shall be of sufficient accuracy to assure operation within the frequency band used.

Sec. 152.45 **Logs.** Each licensee of an amateur station shall keep an accurate log of station operation, including the following data:

a. The date and time of each transmission. (The date need only be entered once for each day's operation. The expression "time of each transmission" means the time of making a call and need not be repeated during the sequence of communication which immediately follows; however, an entry shall be made in the log when "signing off" so as to show the period during which communication was carried on.)

b. The signature of the person manipulating the transmitting key of a radiotelegraph transmitter or the signature of the person operating a transmitter of any other type (type A-3 to A-4 emission) with statement as to type of emission, and the signature of any other person who transmits by voice over a radiotelephone transmitter (type A-3 emission). (The signature need only be entered once in the log provided the log contains a statement to the effect that all transmissions were made by the person named except where otherwise stated. The signature of any other person who operates the station shall be entered in the proper space for his transmissions.)

c. Call letters of the station called. (This entry need not be repeated for calls made to the same station during any sequence of communication, provided the time of "signing off" is given.)

d. The input power to the oscillator, or to the final amplifier stage where an oscillator-amplifier transmitter is employed. (This need be entered only once, provided the input power is not changed.)

e. The frequency band used. (This information need be entered only once in the log for all transmissions until there is a change in frequency to another amateur band.)

f. The location of a portable or portable-mobile station at the time of each transmission. (This need be entered only once provided the location of the station is not changed. However, suitable entry shall be made in the log upon changing location, showing the type of vehicle or mobile unit in which the station is operated and the approximate geographical location of the station at the time of operation.)

g. The message traffic handled. (If record communications are handled in regular message form, a copy of each message sent and received shall be entered in the log or retained on file for at least one year.)

The log shall be preserved for a period of at least one year following the last date of entry. The copies of record communications and station log, as required under this section, shall be available for inspection upon request by an authorized Government representative.

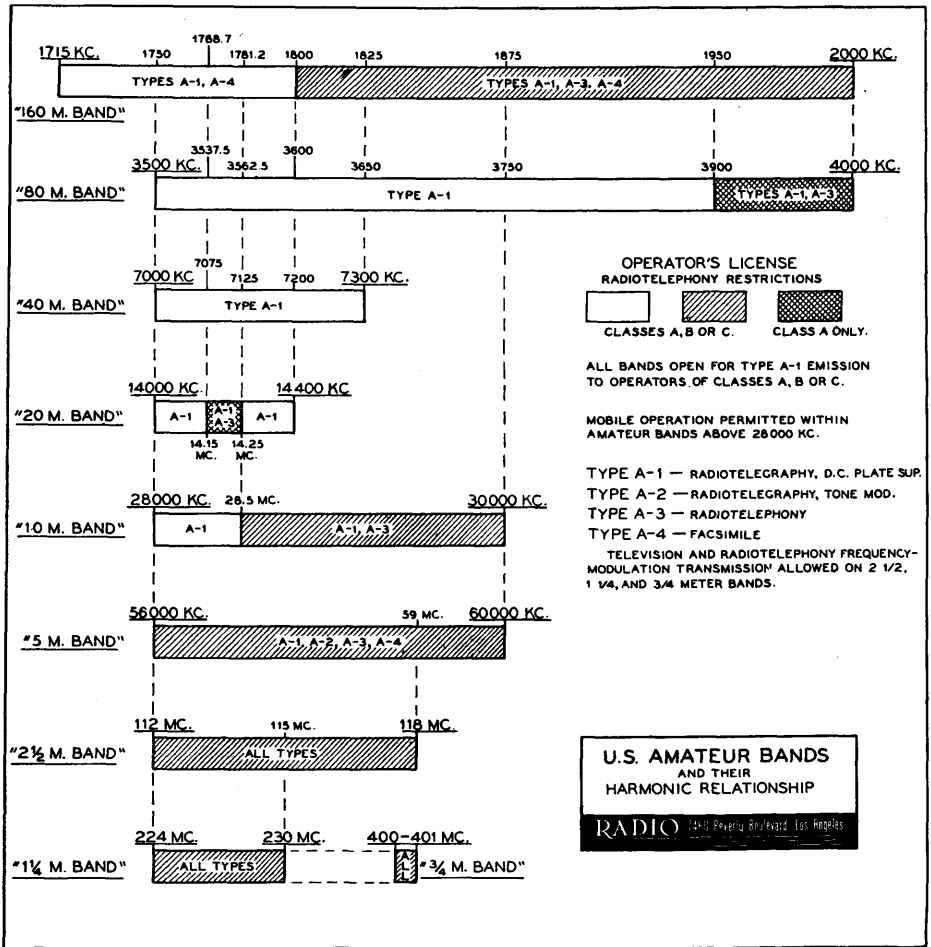

AMATEUR FREQUENCY BANDS.

Effective December 1, 1938. The 1715-2000 kc. band is subject to change to 1750-2050 kc. in accordance with the Inter-American Arrangement covering radiocommunication, Havana, 1937. The Commission reserves the right to change or cancel the frequencies 112-118 Mc. and 224-230 Mc. without advance notice or hearing.

SPECIAL CONDITIONS

Sec. 152.50 Additional conditions to be observed by licensee. An amateur station license is granted subject to the conditions imposed in Sections 152.51 to 152.54 inclusive, in addition to any others that may be imposed during the term of the license. Any licensee receiving due notice requiring the station licensee to observe such conditions shall immediately act in conformity therewith.

Sec. 152.51 Quiet hours. In the event that the operation of an amateur station causes general interference to the reception of broadcast programs with receivers of modern design, such amateur station shall not operate during the hours from 8 o'clock p.m. to 10:30 p.m., local time, and on Sunday for the additional period

from 10:30 a.m. until 1 p.m., local time, upon such frequency or frequencies as cause such interference.

Sec. 152.52 Second notice of same violation. In every case where an amateur station licensee is cited a second time within a year for the same violation under Section 152.25, 152.27, 152.28, 152.30, 152.31, 152.41, or 152.42, the Commission will direct that the station remain silent from 6 p.m. to 10:30 p.m., local time, until written notice has been received authorizing full-time operation. The licensee shall arrange for tests at other hours with at least two amateur stations within fifteen days of the date of notice, such tests to be made for the specific purpose of aiding the licensee in determining whether the emissions

JONES PLUGS — SOCKETS AND TERMINAL PANELS

HEAVY DUTY SERIES

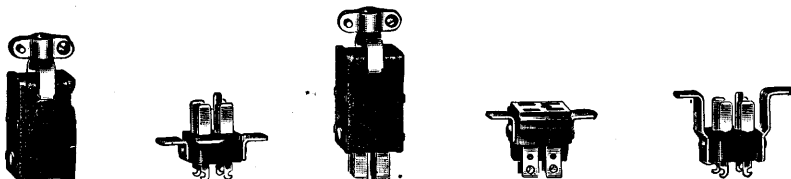

Five numbers of over 200 in the Heavy Duty Series fulfilling practically all plug and socket requirements in Public Address, Radio and kindred fields.

Rugged construction that will withstand hard usage.

Socket Contacts: Knife switch type. Phosphor bronze. Tin plated.

Plug Contacts: Hard brass. Tin plated $\frac{1}{4}$ " x $\frac{1}{16}$ " cross section.

Insulation: Moulded bakelite.

Caps: Steel. Black crackle enamel, baked.

Made in 2, 4, 6, 8, 10 and 12 contacts. The best all around plug and socket at popular prices.

"300" SERIES

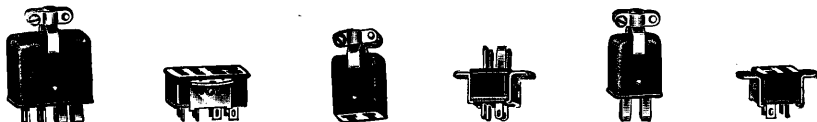

Six numbers of over 100 in the 300 Series. A new line of HIGH GRADE small plugs and sockets, adaptable to thousands of uses. This series has already been purchased in large quantities by nationally known manufacturers of Radio and P. A. equipment.

Priced low, but should not be confused with plugs and sockets manufactured with the express purpose of selling below competition.

All plugs and sockets polarized. Made in 2 contacts to 33 contacts. Phosphor bronze "knife switch" type female contacts. Brass, tin plated male contacts, bar type $\frac{5}{32}$ " x $\frac{3}{64}$ " cross section. Moulded bakelite insulation. Drawn metal caps. Formed fibre linings. Simple assembly. Inexpensive.

TERMINAL PANELS

Manufacturers — Notice:

For years we have been serving manufacturers on requirements for special terminal panels to blue print. Our line of terminals has been developed by customer needs and range from small sizes (2-56 screws), to large sizes. (10-32 screws). Prompt quotation will be supplied upon receipt of blue print or sketch.

Request our Catalog

Jobbers — No. J-38 Manufacturers — No. M-38 Radio Amateurs — No. A-38

HOWARD B. JONES

2300 WABANSIA AVE.

CHICAGO

of his station are in accordance with the Commission's Regulations. The licensee shall report under oath to the Commission at the conclusion of the tests as to the observations reported by amateur licensees in relation to the reported violation. Such reports shall include a statement as to the corrective measures taken to insure compliance with the Regulations.

Sec. 152.53 **Third notice of same violation.** In every case where an amateur station licensee is cited the third time within a year for the same violation as indicated in Section 152.52, the Commission will direct that the station remain silent from 8 a.m. to 12 midnight, local time, except for the purpose of transmitting a prearranged test to be observed by a monitoring station of the Commission to be designated in each particular case. Upon completion of the test the station shall again remain silent during these hours until authorized by the Commission to resume full-time operation. The Commission will consider the results of the tests and the licensee's past record in determining the advisability of suspending the operator license and/or revoking the station license.

Sec. 152.54 **Operation in emergencies.** In the event of widespread emergency conditions affecting domestic communication facilities, the Commission may confer with representatives of the amateur service and others and, if deemed advisable, will declare that a state of general communications emergency exists, designating the licensing area or areas concerned (in general not exceeding 1,000 miles from center of the affected area), whereupon it shall be incumbent upon each amateur station in such area or areas to observe the following restrictions for the duration of such emergency:

a. No transmissions except those relating to relief work or other emergency service such as amateur nets can afford, shall be made within the 1715-2000¹ kilocycle or 3500-4000 kilocycle amateur bands. Incidental calling, testing, or working, including casual conversation or remarks not pertinent or necessary to constructive handling of the general situation shall be prohibited.

b. The frequencies 1975-2000, 3500-3525, and

3975-4000 kilocycles shall be reserved for emergency calling channels, for initial calls from isolated stations or first calls concerning very important emergency relief matters or arrangements. All stations having occasion to use such channels shall, as quickly as possible, shift to other frequencies for carrying on their communications.

c. A five-minute listening period for the first five minutes of each hour shall be observed for initial calls of major importance, both in the designated emergency calling channels and throughout the 1715-2000¹ and 3500-4000 kilocycle bands. Only stations isolated or engaged in handling official traffic of the highest priority may continue with transmissions in these listening periods, which must be accurately observed. No replies to calls or resumption of routine traffic shall be made in the five-minute listening period.

d. The Commission may designate certain amateur stations to assist in promulgation of its emergency announcement, and for policing the 1715-2000¹ and 3500-4000 kilocycle bands and warning non-complying stations noted operating therein. The operators of these observing stations shall report fully the identity of any stations failing, after due notice, to comply with any section of this regulation. Such designated stations will act in an advisory capacity when able to provide information on emergency circuits. Their policing authority is limited to the transmission of information from responsible official sources, and full reports of non-compliance which may serve as a basis for investigation and action under Section 502 of the Communications Act. Policing authority extends only to 1715-2000¹ and 3500-4000 kilocycle bands. Individual policing transmissions shall refer to this Section by number, shall specify the date of the Commission's declaration, the area and nature of the emergency, all briefly and concisely. Policing-observer stations shall not enter into discussions beyond essentials with the stations notified, or other stations.

e. These special conditions imposed under this Section will cease to apply only after the Commission shall have declared such emergency to be terminated.

(See pages 500 and 502 for complete list of radio districts.)



Radio's OUTSTANDING LIBRARY

RADIO, world's foremost technical and constructional magazine for high frequency radio, per year (10 issues)\$2.50

"RADIO" ANTENNA HANDBOOK, over 100 pages on antennas and nothing else; facts, curves, diagrams, tables, charts, no calculations necessary; intensely practical; much more antenna data than in any "general" handbook; per copy\$0.75

"RADIO" HANDBOOK, leading shortwave text, complete, authoritative, practical; 500 pages, no "padding," profusely illustrated; per copy\$1.50

"RADIO" TELEPHONY HANDBOOK (text identical with book formerly called "Amateur Radiotelephony") over 100 pages devoted exclusively to radiotelephony; the "Phone man's 'bible';" per copy\$0.75

RADIO DIGEST, bimonthly, the best from the entire world of radio condensed into each edition; 12 issues for\$2.50

"RADIO" NOISE REDUCTION HANDBOOK, only book of its kind; tells you how to stop or greatly reduce all radio "noise" except static\$0.35

To be released early in 1939
"RADIO" ULTRA HIGH FREQUENCY HANDBOOK, devoted exclusively to the simple yet distinctly different equipment and practice of communication from 12 meters down to micro-waves; per copy\$.50

"RADIO" AMATEUR NEWCOMER'S HANDBOOK; written especially for the beginner; simple theory; getting started; simple receivers and transmitters; how to get your license; radio laws; per copy\$0.35

Above prices are for continental U. S. A. only; for rates elsewhere see individual advertisements in this book or send stamp for catalog.

RADIO
LIMITED

TECHNICAL PUBLISHERS · 7460 BEVERLY BLVD. · LOS ANGELES

RADIO DISTRICTS

Territory embraced and address of inspector in charge.
 (Do not confuse with call areas.)

Radio District	Address of the Inspector in Charge	Territory Within District	
		States, Etc.	Countries
1	Customhouse, Boston, Mass..	Connecticut	All counties.
		Maine	Do.
		Massachusetts	Do.
		New Hampshire	Do.
		Rhode Island.....	Do.
		Vermont	Do.
3	Federal Building, New York, N. Y.	New Jersey.....	Bergen, Essex, Hudson, Hunterdon, Mercer, Middlesex, Monmouth, Morris, Passaic, Somerset, Sussex, Union, and Warren.
		New York.....	Albany, Bronx, Columbia, Delaware, Dutchess, Greene, Kings, Nassau, New York, Orange, Putnam, Queens, Rensselaer, Richmond, Rockland, Schenectady, Suffolk, Sullivan, Ulster, and Westchester.
3	New United States Customhouse, Philadelphia, Pa.	Delaware	Newcastle.
		New Jersey.....	Atlantic, Burlington, Camden, Cape May, Cumberland, Gloucester, Ocean, and Salem.
		Pennsylvania	Adams, Berks, Bucks, Carbon, Chester, Cumberland, Dauphin, Delaware, Lancaster, Lebanon, Lehigh, Monroe, Montgomery, Northampton, Perry, Philadelphia, Schuylkill, and York.
4	Fort McHenry, Baltimore, Md.	Delaware	Kent and Sussex.
		District of Columbia..	All counties.
		Maryland	Do.
		Virginia	Arlington, Clark, Fairfax, Fauquier, Frederick, Loudoun, Page, Prince William, Rappahannock, Shenandoah, and Warren.
5	New Post Office Building, Norfolk, Va.	North Carolina	All except district 6.
		Virginia	All except district 4.
6	New Post Office Building, Atlanta, Ga.	Alabama	All counties.
		Georgia	Do.
		North Carolina	Ashe, Avery, Buncombe, Burke, Caldwell, Cherokee, Clay, Cleveland, Graham, Haywood, Henderson, Jackson, McDowell, Macon, Madison, Mitchell, Polk, Rutherford, Swain, Transylvania, Watauga, and Yancey.
		South Carolina	All counties.
		Tennessee	Do.
7	Post Office Box 150, Miami, Fla.	Florida	Do.
		Puerto Rico	Do.
		Virgin Islands.....	Do.
8	Customhouse, New Orleans, La.	Arkansas	Do.
		Louisiana	Do.
		Mississippi	Do.
		Texas	City of Texarkana only.
9	Prudential Building, Galveston Tex.	Texas	Aransas, Brazoria, Brooks, Calhoun, Cameron, Chambers, Fort Bend, Galveston, Goliad, Harris, Hidalgo, Jackson, Jefferson, Jim Wells, Kenedy, Kleberg, Matagorda, Nueces, Refugio, San Patricio, Victoria, Wharton, and Willacy.

EL "Radio" Handbook

Edición Español

EL "RADIO" HANDBOOK es el libro de radio más famoso e importante del mundo en su carácter de obra divulgadora para el amateur. Este libro, conocido en los Estados Unidos como la autoridad más importante del mundo de la radio, se edita originalmente en inglés en California, y representa el esfuerzo más serio y ordenado hecho en favor del estudioso y del aficionado. El "RADIO" HANDBOOK no es una obra anónima; no es un libro escrito por aficionados. Es la obra cumbre del talento maduro e inimitable del radio-ingeniero Frank C. Jones, W6AJF, uno de los más ilustres "pioneers" de la radio en el mundo, y de los redactores ingenieros de la revista "RADIO."

El "RADIO" HANDBOOK, edición 1939, tendrá mas que 500 páginas, y sus sujetos incluyen todos los sujetos que incluye esta edición inglesa, con excepción de las leyes de la radio de los Estados Unidos.

El "RADIO" HANDBOOK, edición español, se remite franco de porte por correo certificado al precio de \$5.00, moneda nacional de la República Argentina. Aceptamos en pago giros y cheques sobre Buenos Aires, La Paz, Río de Janeiro. Santiago de Chile, Lisboa, Lima, Montevideo, y Nueva York; también aceptamos billetes de banco de sus naciones los cuales deben venir en carta certificada.

Editorial Pan America
Perú 677
Buenos Aires, Argentina

As in former years, this edition of the "RADIO" HANDBOOK is available in English or Spanish. The Spanish edition is published under license by Editorial Pan America, Peru 677, Buenos Aires, Argentina, to whom all inquiries and orders should be directed. The list price is \$5.00, Buenos Aires funds. Copies may be obtained at retail (\$1.65, postpaid) from Radio Ltd., 7460 Beverly Boulevard, Los Angeles.

RADIO DISTRICTS (Continued)

10	Federal Building, Dallas, Tex.	New Mexico..... Oklahoma..... Texas.....	All counties. Do. All except district 9 and the city of Texarkana.
11	Rives-Strong Building, Los Angeles, Calif.	Arizona..... California..... Nevada.....	All counties. Imperial, Inyo, Kern, Los Angeles, Orange, Riverside, San Bernardino, San Diego, San Luis Obispo, Santa Barbara, and Ventura. Clarke.
12	Customhouse, San Francisco, Calif.	California..... Nevada..... Guam..... Midway..... Wake..... American Samoa.....	All except district 11. All except Clarke.
13	New United States Court- house, Portland, Ore.	Idaho..... Oregon.....	All except district 14. All counties.
14	Federal Office Building, Se- attle, Wash.	Alaska..... Idaho..... Montana..... Washington.....	Benewah, Bonner, Boundary, Clearwater, Idaho, Kootenai, Latah, Lewis, Nez Perce, and Shoshone. Beaverhead, Broadwater, Cascade, Deer- lodge, Flathead, Gallatin, Glacier, Gran- ite, Jefferson, Lake, Lewis and Clark, Lincoln, Madison, Meagher, Mineral, Missoula, Pondera, Powell, Ravalli, Sanders, Silver Bow, Teton, and Toole. All counties.
15	Customhouse, Denver, Colo.	Colorado..... Montana..... Utah..... Wyoming.....	Do. Except district 14. All counties. Do.
16	New Main Post Office Build- ing, St. Paul, Minn.	Minnesota..... Michigan..... North Dakota..... South Dakota..... Wisconsin.....	Do. Alger, Baraga, Chippewa, Delta, Dickin- son, Gogebic, Houghton, Iron, Kewee- naw, Luce, Mackinac, Marquette, Menominee, Ontonagon, and School- craft. All counties. Do. All except district 18.
17	Federal Building, Kansas City, Mo.	Iowa..... Kansas..... Missouri..... Nebraska.....	Do. All counties. Do. Do.
18	Engineering Building, Chi- cago, Ill.	Illinois..... Indiana..... Iowa..... Wisconsin.....	All counties. Do. Allamakee, Buchanan, Cedar, Clayton, Clinton, Delaware, Des Moines, Du- buque, Fayette, Henry, Jackson, John- son, Jones, Lee, Linn, Louisa, Musca- tine, Scott, Washington, and Winne- shiek. Columbia, Crawford, Dane, Dodge, Grant, Green, Iowa, Jefferson, Kenosha, La- fayette, Milwaukee, Ozaukee, Racine, Richland, Rock, Sauk, Walworth, Washington, and Waukesha.
19	New Federal Building, De- troit, Mich.	Kentucky..... Michigan..... Ohio..... West Virginia.....	All counties. All except district 16. All counties. Do.
20	Federal Building, Buffal- o, N. Y.	New York..... Pennsylvania.....	All except district 2. All except district 3.
21	Aloha Tower, Honolulu, Ter- ritory of Hawaii	Territory of Hawaii..	

Centralab

is a synonym for quality with thousands of hams—service men—experimenters and set builders the world over.

A Quality product—for Quality performance. Centralab gives you a definite assurance of sustained service under all sorts of adverse conditions.

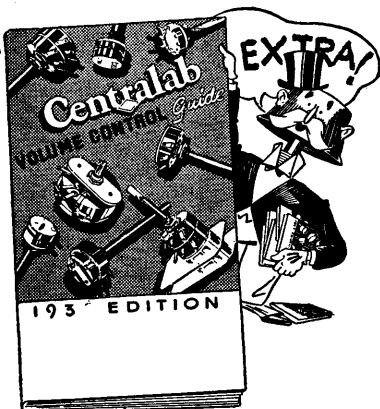

Write for the new edition of Centralab Volume Control Guide—listing thousands of receivers — old and current models. Price 10c . . . or free at your jobber.

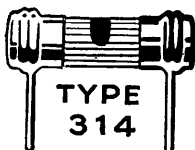

Centralab Fixed Resistors

baptized in fire to withstand vibration, humidity, and temperature fluctuations . . . ceramic jacket is baked to center core of graphite. In standard or center lead style. Uniform resistance and load distribution over ENTIRE length.

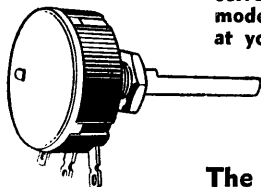

The Famous Radiohm

Millions in use as original equipment and as replacements. Uses the famous non-rubbing smooth contact for noiseless attenuation. Available in various combinations

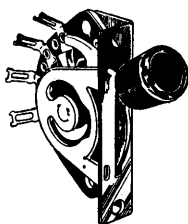

Lever Action Switch

For broadcasting, radio receiving, P.A. Test Instruments, and Industrial Use. Furnished in two or three positions. Index action can be positive in all positions, or spring return to either side.

Low Capacity Selector Switch

Now infinite switching combinations are available at your jobber. Made in Isolantite or Bakelite.



At your jobber or write

CENTRALAB

Division of Globe Union Inc.
 MILWAUKEE

Another
"Only book of its kind"



The "RADIO" Noise Reduction Handbook

by

The Editors of "RADIO"

Tells how to reduce practically every form of radio noise except natural static. Gives complete information on all representative circuits, together with a "new" highly-efficient (but somewhat tricky) noise-balancing circuit—really an adaptation of an old telephone trick to radio use. For the novice several noise-limiters are described which are very simple, yet will effect real improvements at noisy locations.

Obtainable from your favorite dealer or direct from us if he cannot supply you. The price is only

35c in U. S. A.

40c or 1s. 8d. elsewhere. British postal orders accepted.

RADIO

TECHNICAL PUBLISHERS · 7460 BEVERLY BLVD. · LOS ANGELES

The RADIO Antenna Handbook

2. CHOOSING AN ANTENNA

THE SMITH BE-SQ ARE BEAM
 Four dipoles can be formed into the shape of a square as in figure 28. To produce a beamlike radiator that has characteristics similar to the "X" or "H" stacked coil array, the dipoles should be slightly less directivity and radiation resistance. An identical square element can be supported at right angles from the same pole to give complete coverage. Such

ation resistance of the four-armed version results in considerably higher voltage at the voltage loops.
 Approximate stub lengths are given in the diagram in terms of wavelength. These can be converted to feet by referring to the table on page 24. Exact adjustment of the stub length and position of the feeder attachment in the stub can be obtained by following the general

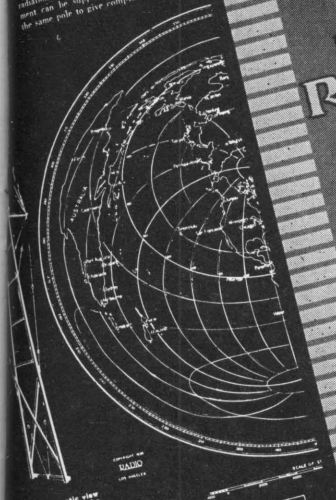
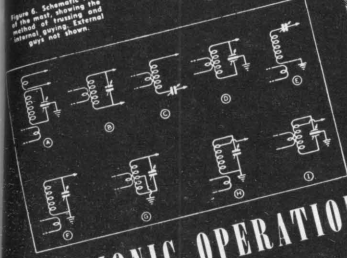

Figure 6. Schematic view of four-armed antenna showing effect of rotating and tilting stub. External feed not shown.



6. COUPLING TO THE TRANSMITTER

7. SUPPORTING THE ANTENNA

1. FUNDAMENTAL Characteristics and Constants

Frequency Kilocycles	L Feet	W Feet
3500	133' 7"	129' 10"
3600	128' 4"	125'
3700	119' 10"	118' 4"
3800	118' 10"	116' 10"
3900		
4000		
7000	66' 0"	66' 0"
7050	65' 10"	65' 10"
7100	65'	65'
7150		

A small percentage of the total energy is reflected back to the transmitting system.

3. FEEDING THE ANTENNA

Shorted-Stub Tuning Procedure
 When the antenna requires a shorted stub, a large number of quarter waves if the antenna is voltage fed; even number of quarter waves if radiator is current fed; the tuning procedure is as follows:
 Short a section of the radiator (or one of the half wave sections if harmonically operated)

4. TRANSMISSION and Feed S

The Twisted-Pair Line
 The recent development of impedance transmission cable allows a very desirable transmission to be used to convey energy from the transmitter. The loss is largely due to the insulation, low loss insulation, low loss insulation.

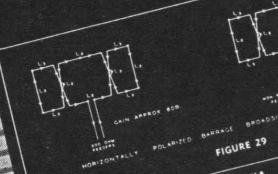

THE END-FED ANTENNA

The end-fed "Purcell" antenna has no feed line to couple the antenna to the transmitter. The antenna is fed by a single wire that runs down the length of the antenna. The radiation pattern is shown in the diagram.



7. DIRECTIVE PROPERTIES OF A Directional Arrays

A high-frequency doublet or directional array is usually mounted as high and in the clear as possible for obvious reasons. Power commonly used with low beams. The antenna can be of higher harmonics.

8. DIRECTABLE ARRAY ROTATING MECHANISM

ROTATING THE FLAT-TOP BEAM
 A single-section flat-top beam (described in preceding chapter) makes a compact and effective directional array of the simple

9. U.H.F. ANTENNA

Salvaging "Halfyardless"
 It is not necessary to take down a mast when the halfyard breaks. There is an easier method that is just as effective if the pole or mast is saved right at the top.

10. RECEIVING ANTENNAS

Screw eyes should not be pulled tension, as ultimately they will pull out. They should be on them. They should be on them. They should be on them. They should be on them.

SEVENTY-FIVE CENTS in U.S.A. Elsewhere, 85c or 3s. 6d. Canadian Postal Notes and British Postal Orders Accepted

RADIO LIMITED Technical Publishers

7460 Beverly Boulevard, Los Angeles, California

RULES OF THE BOARD OF UNDERWRITERS

RECEIVING STATIONS

Owners of insured residences and buildings are compelled to comply with the following Underwriters' rules:

a—Outdoor antenna and counterpoise conductor sizes shall not be less than no. 14 if copper or no. 17 if of bronze or copper-clad steel. Antenna and counterpoise conductors outside of buildings shall be kept well away from all electric light and power wires or any circuit of more than 600 volts, and from railway, trolley or feeder wires, so as to avoid the possibility of contact between the antenna or counterpoise and such wires under accidental conditions.

b—Antenna and counterpoise where placed in proximity to electric light or power wires of less than 600 volts, or signal wires, shall be constructed and installed in a strong and durable manner, and shall be so located and provided with suitable clearances to prevent accidental contact with such wires by sagging or swinging.

c—Splices and joints in the antenna span shall be soldered unless made with approved splicing devices.

d—The preceding paragraphs a, b, and c, shall not apply to power circuits used as receiving antenna, but the devices used to connect the light and power wires to radio receiving sets shall be of approved type.

e—Lead-in conductors, that is, conductors from outdoor antennas to protective devices, shall be of copper, approved copper-clad steel or other metal which will not corrode excessively and in no case shall they be smaller than no. 14, except that bronze or copper-clad steel not less than no. 17 may be used.

f—Lead-in conductors from the antenna to the first building attachment shall conform to the requirements for antennas similarly located. Lead-in conductors from the first building attachment to the building entrance shall, except as specified in the following paragraph, be installed and maintained so that they cannot swing closer to open supply conductors than the following distances:

Supply wires 0 to 600 volts...2 feet
Supply wires exceeding 600 volts 10 feet

Where all conductors involved are supported so as to secure a permanent separation and the supply wires do not exceed 150 volts to ground, the clearance may be reduced to not less than 4 inches. Lead-in conductors on the outside of buildings shall not come nearer than the clearances specified above to electric light and power wires unless separated therefrom by a continuous and firmly fixed non-conductor which will maintain permanent separation. The non-conductor shall be in addition to any insulating covering on the wire.

g—Each lead-in conductor from an outdoor antenna shall be provided with an approved protective device (lightning arrester) which will operate at a voltage of 500 volts or less, properly constructed and located either inside the building at some point between the entrance and the set which is convenient to a ground, or outside the building as near as practicable to the point of entrance. The protector shall not be placed in the immediate vicinity of easily ignitable material, or where exposed to inflammable gases or dust or flyings of combustible materials.

h—The grounding conductor from the protective device may be bare and shall be of copper, bronze or approved copper-clad steel, and if entirely outdoors shall not be smaller than no. 14 if of copper nor smaller than no. 17 if of bronze or copper-clad steel. If wholly indoors or with not more than ten feet outdoors it need not be larger than no. 18. The protective grounding conductor shall be run in as straight a line as possible from the protective device to a good permanent ground. The ground connections shall be made to a cold-water pipe where such pipe is available and is in service connected to the street mains. An outlet pipe from a water tank fed from a street main or a well may be used, providing such outlet pipe is adequately bonded to the inlet pipe connected to the street water main or well. If water pipes are not available, ground connections may be made to a grounded steel frame of a building or to a grounding electrode, such as a galvanized pipe or rod driven into permanently damp earth or to a metal plate or other body of metal buried similarly. Gas piping shall not be used for the ground.

i—The protective grounding conductor shall be guarded where exposed to mechanical injury.

An approved ground clamp shall be used where the protective grounding conductor is connected to pipes or piping.

j—The protective grounding conductor may be run either inside or outside the building. The protective grounding conductor and ground, installed as prescribed in the preceding paragraphs *h* and *i* may be used as the operating ground.

k—Wires inside buildings shall be securely fastened in a workmanlike manner and except as provided in paragraph *m* of this section shall not come nearer than two inches to any electric light or power wire not in conduit unless separated therefrom by some continuous and firmly fixed non-conductor, such as porcelain tubes or approved flexible tubing, making a permanent separation. This non-conductor shall be in addition to any regular insulating covering on the wire.

l—Storage battery leads shall consist of conductors having approved rubber insulation. The circuit from a filament

“A,” storage battery of more than 20 ampere-hours capacity, NEMA rating, shall be properly protected by a fuse of circuit-breaker rated at not more than 5 amperes. The circuit from a plate, “B,” storage battery or power supply shall be properly protected by a fuse.

TRANSMITTING STATIONS

The following paragraphs apply to amateur stations only:

a—Antenna and counterpoise conductors outside buildings shall be kept well away from all electric light or power wires or any circuit of more than 600 volts, and from railway, trolley or feeder wires, so as to avoid the possibility of contact between the antenna or counterpoise and such wires under accidental conditions. Antenna and counterpoise conductors when placed in proximity to electric light or power wires of less than 600 volts, or signal wires, shall be constructed and installed in a strong and durable manner, and shall be so located and provided with suitable clearances as to prevent accidental contact with such wires by sagging or swinging.

NEW MULTI-UNIT **Microphones**

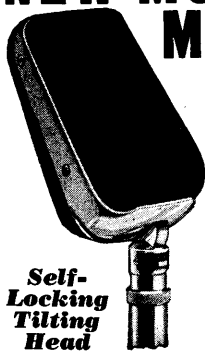

**Self-Locking
 Tilting
 Head**

A new crystal microphone designed by Astatic Engineers especially for public address and night club installations. Cannot be acoustically overloaded. Complete with interchangeable locking connector and 25-ft. cable. Chrome and black finish. Full year guarantee.

List Prices:

- MU-2 \$29.50
- MU-4 39.50



ASTATIC MICROPHONE LABORATORY, Inc.

Pioneer Manufacturers of Quality Crystal Devices

DEPT. N-3, YOUNGSTOWN, OHIO

Licensed Under Brush Development Co. Patents

MODEL 0-7 PICKUP

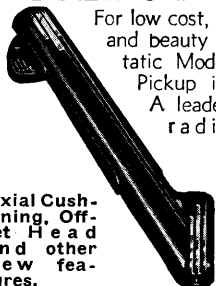

For low cost, high efficiency and beauty of design, Astatic Model 0-7 Crystal Pickup is unsurpassed.

A leader for modern radio phonograph combinations. Streamlined. Full year guarantee.

Axial Cushioning, Off-set Head and other new features.

New Low List Price \$6.50

MODEL D-104

A Big Favorite With Amateurs



Popular design, rugged construction, low price and exceptional quality performance in the “speech range.” Chrome and black finish. Complete with interchangeable plug and socket connector and 8-ft. cable.

**List Price \$22.50
 See Your
 Astatic Jobber**

b—Antenna conductor sizes shall not be less than given in the following table: a non-absorptive insulating support, such as treated pins or brackets, equipped

Material	Stations to which power supplied is less than 100 watts and voltage of power is less than 400 v.	Stations to which power supplied is more than 100 watts or voltage of power is more than 400 volts
Soft copper	No. 14	No. 7
Medium-drawn copper.....	No. 14	No. 8
Hard-drawn copper.....	No. 14	No. 10
Bronze or copper-clad steel.....	No. 14	No. 12

c—Splices and joints in the antenna and counterpoise span shall be soldered joints unless made with approved splicing devices.

d—Lead-in conductors shall be of copper, bronze, approved copper-clad steel or other metal which will not corrode excessively and in no case shall be smaller than no. 14.

e—Antenna and counterpoise conductors and wires leading therefrom to ground switch, where attached to buildings, shall be firmly mounted five inches clear of the surface of the building, on

with insulators having not less than five inches creepage and air-gap distance to inflammable or conducting material, except that the creepage and air-gap for continuous wave sets of 1,000 watts and less input to the transmitter shall not be less than 3 inches.

f—In passing the antenna or counterpoise lead-in into the building, a tube slanting upward toward the inside or a bushing of non-absorptive insulating material shall be used, and shall be so insulated as to have a creepage and air-gap distance in the case of continuous wave sets of 1,000 watts and less input to the transmitter, not less than three inches, and in other cases not less than five inches. Fragile insulators shall be protected where exposed to mechanical injury. A drilled window pane may be used in place of a bushing, provided the creepage and airgap distance, as specified above, are maintained.

g—Adequate lightning protection either in the form of a grounding switch or suitable lightning arrester shall be provided. The grounding conductor for such protection shall be at least as large as the lead-in and in no case smaller than no. 14 copper, bronze, or approved copper-clad steel. The protective grounding conductor need not have an insulating covering or be mounted on insulating supports. The protective grounding conductor shall be run in as straight a line as possible to a good, permanent ground suitable for the purpose. The protective grounding conductor shall be protected where exposed to mechanical injury.

h—The operating grounding conductor where used shall be of copper strip not less than 3/8 inch wide by 1/32 inch thick, or of copper, bronze or approved copper-clad steel having a periphery, or girth, of at least 3/4 inch, such as no. 2

"CHI-RAD"

Amateur Headquarters

Since 1921

Everything for the amateur and short wave experimenter. Complete line of all the best parts and equipment.

We sell every good receiver on the market on the best terms you can get anywhere.

SEND FOR OUR RECEIVER
 TIME PAYMENT TERMS

Catalog of parts and receivers on request.

Chicago Radio Apparatus Co., Inc.
415 S. Dearborn St.,
Chicago, USA

wire, and shall be firmly secured in place throughout its length.

i—The operating grounding conductor shall be bonded to a good, permanent ground. Preference shall be given to water piping. Other permissible grounds are grounded steel frames of buildings or other grounded metal work in the building, and artificial grounding devices such as driven pipes, rods, plates, cones, etc. Gas piping shall not be used for the ground.

j—The transmitter shall be enclosed in a metal frame, or grill, or separated from operating space by a barrier or other equivalent means, all metallic parts of which are effectually connected to ground.

k—All external metallic handles and controls accessible to the operating personnel shall be effectually grounded.

No circuit in excess of 150 volts should have any parts exposed to direct contact. A complete dead-front type of switchboard is preferred.

l—All access doors shall be provided with interlocks which will disconnect all voltages in excess of 750 volts when any access door is opened.

m—Under the conditions noted in paragraphs 1 and 2, below, wiring may be grouped in the same conduit armored cable, electrical metallic tubing, metal raceway, pull-box, junction box or cabinet.

1. When power-supply wires are introduced solely for supplying power to the equipment to which the other wires are connected.

2. Wires other than power-supply wires run in conduit, armored cable, electrical metallic tubing, metal raceways, pull-box, junction box or cabinet with power-supply wires are insulated individually or collectively in groups by insulation at least equivalent to that on the power-supply wires or the power and other wires are separated by a lead sheath or other continuous metallic sheathing.

A BOOK FULL OF NEW IDEAS *For Beginners · Amateurs · Experimenters · Service Men · Designers · Constructors.*

NEW

Knobs in brilliant colors.—Modern dial plates.— Precision tuning controls. — Construction sundries.

AND

a startling new group of streamlined professional-type dials for transmitters and communication receivers.

CONVENTIONAL

and more conservative components that you already know are included for those who prefer them.

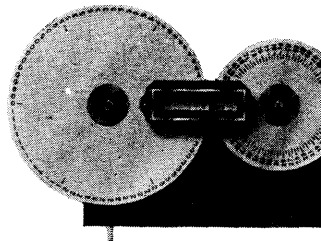

This precision tuner is only one of the many new items illustrated in Bulletin 225 and sold by your jobber.

ASK FOR YOUR COPY of BULLETIN 225

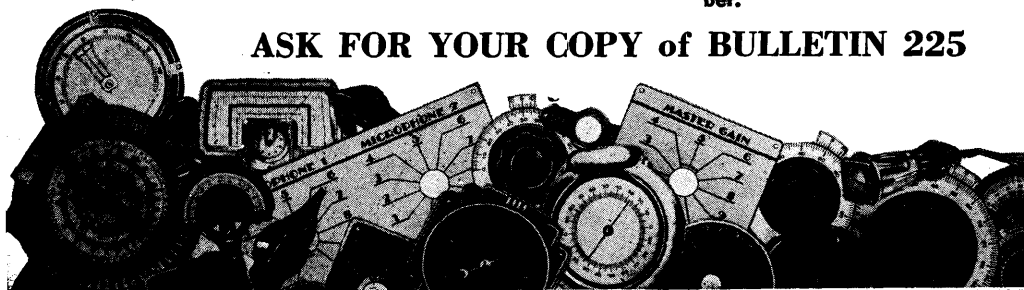

CROWE NAME PLATE & MANUFACTURING CO.
 1762 Grace St., Chicago, Illinois · Cable Address: CRONAME-CHICAGO

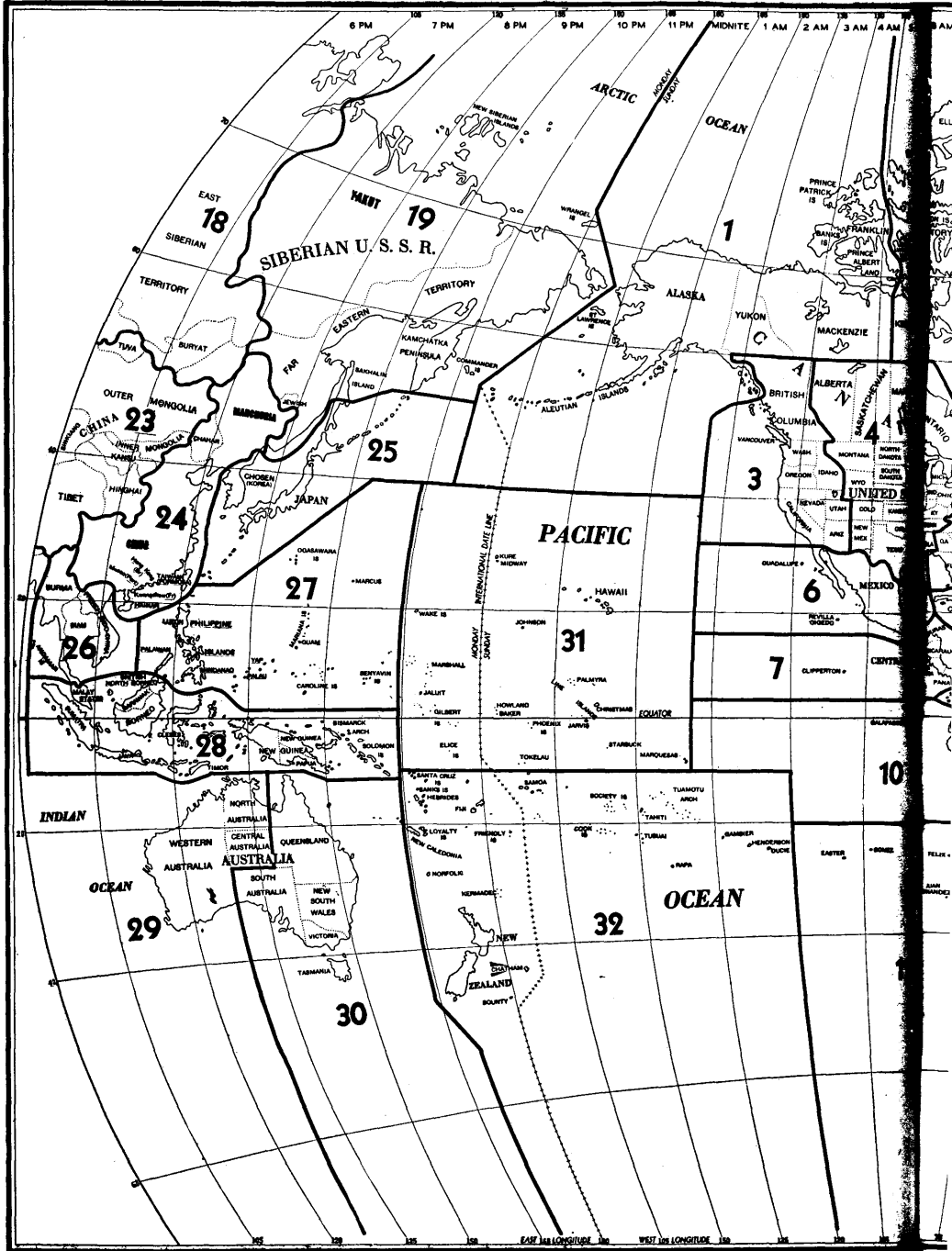

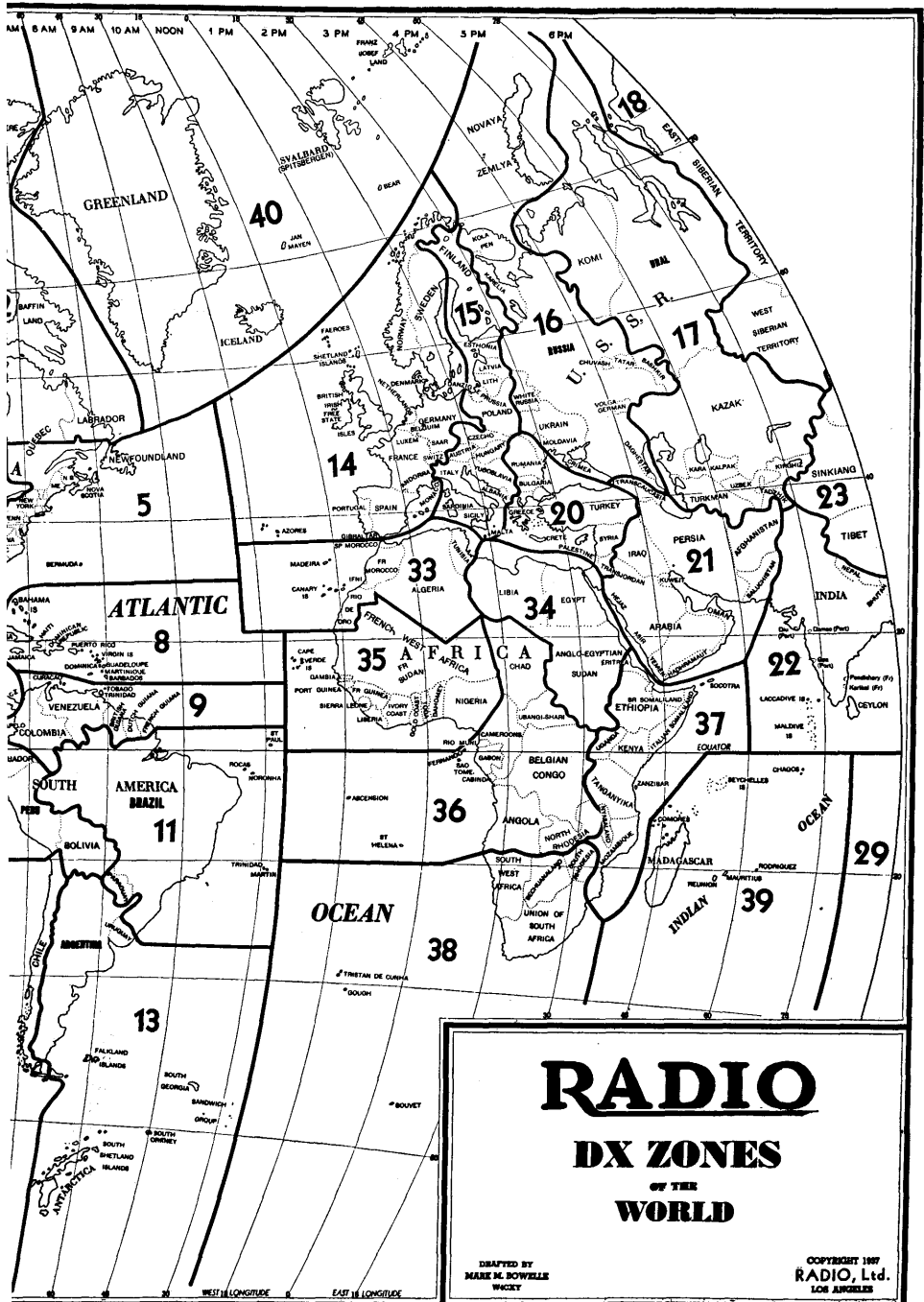

PERTINENT EXCERPTS FROM RADIO LAWS AFFECTING RADIO AMATEURS

Any licensee receiving notice of violation of radio laws shall reply to said notice in writing to the F.C.C. at Washington.

Requests for special call-letters will not be considered.

The person manipulating the telegraph key of an amateur station must be a duly licensed operator.

The original license shall be posted in the station or kept in the personal possession of the operator on duty, except when it has been mailed to an office of the F.C.C. for endorsement or change before date of its expiration.

Amateur stations must not be used to handle messages for pecuniary interests, direct or indirect, paid or promised.

Amateur transmissions must be free from harmonics. Loosely-coupled circuits must be used, or devices that will result in giving equivalent effects to minimize keying impacts, clicks, harmonics and parasitics.

Phone transmitters must not be modulated in excess of their modulation capability, and means must be incorporated to insure against such overmodulation.

One kw. power input to the stage which feeds the antenna is the maximum

permissible power for amateur operation.

Amateur operators must transmit their assigned call letters at the end of each transmission, or at least once during each 10 minutes of operation. If an amateur transmitter causes general interference with reception of broadcast signals in receivers of modern design, that amateur station shall not operate during the hours from 8 p.m. to 10:30 p.m., local time, and on Sundays from 10:30 a.m. until 1 p.m., local time, in addition to the evening silent period, upon such frequency or frequencies as cause such interference.

Each licensee of an amateur station must keep *an accurate log* of station operation, name of person operating the transmitter, with statement as to the nature of transmission. The call letters of the station, the input power to the stage which feeds the antenna, the frequency band used, the location of the station if portable operation is used, must all be entered in the station *log*.

A copy of each message sent and received must be kept on file for at least one year. This information must be available on request by authorized representatives of the Government of the United States.

Distress Signals

The International Distress Signal is . . . — — — . . . (three dots, three dashes, three dots). The distress signal is *not* SOS; it is an easily recognized group of *characters* of three dots, three dashes, three dots. For radiotelephony distress calls the signal is *MAYDAY*. All communications must cease when a distress call is heard. Communication must not be resumed until it has been definitely determined that all is clear again. When you hear a distress call, notify the nearest source from which aid can be secured.

It is unlawful to send fraudulent signals of distress or communications relating thereto; to interfere maliciously with any other radio communication. Distress

calls have precedence over all others. Minimum power must be used to effect reliable communication. The use of profane language is prohibited. The contents or meaning of a message must be kept secret, except to an authorized agency which takes part in the forwarding of the message, or to the addressee or his agent, or upon the demand of a court of competent jurisdiction or authority.

Secrecy provisions do not apply to broadcasts for public use, or to distress calls. In the event of a national emergency the station can be ordered closed.

In the event of an emergency an amateur station is permitted to communicate with stations other than amateur.

NO "GETTER"

NO GAS

NO FAILURES

Eimac
TUBES

5 ESTABLISHED FACTS . . . (1) Most tube failures are caused by gas released internally. (2) Excessive heat releases gas from certain types of tube elements . . . especially internal insulators. (3) High anode temperatures alone do not destroy emission. (4) The use of a chemical agent or "getter" is not necessary to obtain good vacuum. (5) "Getter" may release gas that will destroy emission.

EIMAC DEVELOPMENTS . . . (1) Plates and grids made of tantalum because it has the smallest original gas content of any known metal. (2) Eimac developed a new process which removes this small gas content from tantalum . . . renders it completely degassed. (3) Eimac tubes undergo a long, severe exhaust . . . NO "GETTER" is employed. (4) New, radical design greatly reduces inter-electrode capacities and entirely eliminates the use of internal insulators. (5) A new type thoriated tungsten filament possessing the highest possible thermionic efficiencies, longer life and uniformity. (6) *Eimac tubes are conservatively rated as to plate dissipation and are unconditionally guaranteed against tube failure caused by gas released internally.* Momentary overloads of from 400% to 600%, which are sufficient to cause the anode to become incandescent, will positively not release gas.



KY21 GRID CONTROL RECTIFIER

Net Price \$10

KY21 is a mercury vapor rectifier to which has been added a control electrode, or grid. Used as a rectifier and as a power control tube. Very small control power is needed and when properly handled KY21 tubes will eliminate "key clicks," permitting high power operation in congested areas. D.C. output 3500 volts at 1.5 amperes.

RX21 RECTIFIER Net Price \$7.50

A mercury vapor rectifier possessing unusually high inverse voltage capabilities. D.C. output 3500 volts at 1.5 amperes.



The new VACUUM TANK CONDENSER

This new condenser eliminates the use of the old fashioned open plate type, provides a positive, accurate means to determine the optimum "Q" of your tank circuit, assures proper load balance on each of the tubes and minimizes "splatter" on phone signals. No loss of power on a stray harmonic, no loss of efficiency. The single units are available in 6, 12, 25 and 50 mmfd capacities . . . priced net at \$7.50, \$8.50, \$10.50 and \$12.50 respectively.

YCG
YC12
YC25
YC50

For purposes of illustration tubes are shown the same. Physical dimensions are as follows: 35T, overall height 1 1/2 inches; 100T, 7 1/2 inches; 250T, 9 1/2 inches; 450T, 12 1/2 inches; 750T, 16 1/2 inches. Vacuum densifiers are 6 1/2 inches long, and RX21 tubes 7 1/2 inches



EIMAC
35T

35T

Net Price \$6.00



250T

Net Price \$24.50



100T

Net Price \$13.50

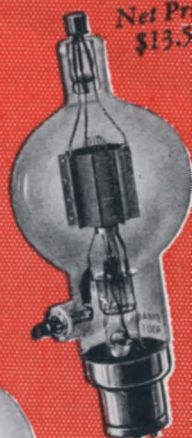

450T

Net Price \$75.00



750T

Net Price \$175.00



Presenting... The RCA POWER

Every amateur requirement is capably filled by these outstanding RCA tubes. Not only do they give you the advantages of advanced engineering design—they provide the finest in quality at prices you can afford to pay!



RCA PENTODES

The RCA Pentodes are extremely popular for power amplifiers where suppressor-grid modulation is employed. They also make excellent crystal oscillators. In many circuits, Pentodes reduce number of tubes.

The RCA-802 is a power amplifier pentode that is popularly used as a crystal oscillator. In r-f amplifiers the low grid-plate capacitance of the RCA-802 eliminates the need for neutralization in adequately shielded circuits. Price \$3.50.

The RCA-803 is a heavy duty pentode. In Class "C" service, it has a power output of 210 watts with 4.4 watts driving power. Price \$34.50.

The RCA-804 (illustrated) may be used as an r-f amplifier, frequency multiplier, oscillator, and suppressor-grid or plate-modulated amplifier. In shielded circuits, neutralization is generally unnecessary. Price \$15.00.

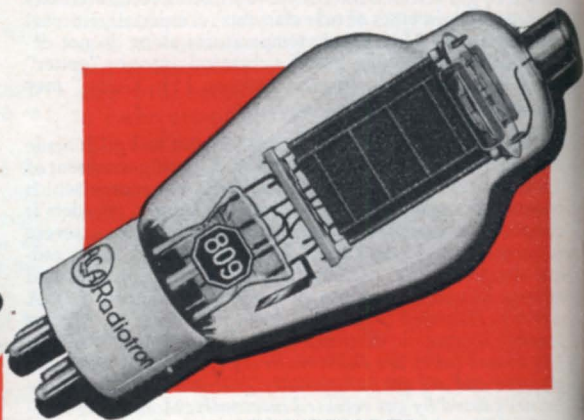

RCA TRIODES

Amateurs have found that the RCA Triode Group of Power Tubes is excellent for general purpose use. They are suitable for use as oscillators, amplifiers, frequency multipliers, and a-f modulators.

The RCA-808 is a medium-power triode of the high-mu, thoriated-tungsten filament type. The plate connection is brought out through a separate seal at the top of the bulb, while the grid connection is brought out by a separate seal in the lower part of the bulb near the base. This insures good insulation and low interelectrode capacitances. In Class C telegraphy service, the RCA-808 has a power output of 140 watts and requires only 9.5 watts driving power. Price \$7.75.

The RCA-809 (illustrated) is an unusually popular tube with the Transmitting Amateur. It may be operated at maximum ratings at frequencies as high as 60 megacycles. Two RCA-809's in a push-pull circuit deliver over 100 watts of r-f power to the antenna. An outstanding value for \$2.50.

The RCA-833 is a high-mu triode of the thoriated-tungsten filament type. Because of its high permeance, it may be operated at high plate efficiency with low driving power. Its new design with post terminals provides a rugged structure and makes bases unnecessary. It contains a minimum amount of insulation within the tube. Price \$85.00.



Radio Tubes

Stars of the TUBE LEAGUE!



RCA BEAM POWER TUBES

The outstanding feature of the RCA Beam Power Group is their high power output with low driving power requirements.

The RCA-807 is the smallest RCA Beam Power Amplifier available in the transmitting tube line. It has the inherent feature of high power sensitivity characteristic of beam power amplifiers which makes it especially suitable for use as an r-f or a-f amplifier, crystal oscillator, and frequency multiplier. It may be operated up to maximum ratings in all classes of service at frequencies as high as 60 megacycles. In Class AB₂ audio service two tubes are capable of delivering an output of approximately 80 watts. \$3.50.

The RCA-813 is the largest of the Beam Power transmitting tube group. It will deliver over 260 watts output per tube with less than 1 watt driving power—a truly remarkable performance. As a result of its construction, the 813 can be operated at maximum ratings at frequencies as high as 30Mc and at reduced ratings as high as 120Mc. \$28.50.

The RCA-814 transmitting Beam Power Amplifier (illustrated) has the unusual characteristic of delivering 130 watts output in Class C telegraphy service with only 1.5 watts driving power. It features a new design involving the use of directed electron beams. The RCA-814 may be operated at frequencies as high as 30 megacycles. \$17.50.

REMEMBER—RCA makes tubes for every amateur application—providing the finest in quality at prices you can afford to pay!



RCA RECTIFIERS

RCA Rectifiers furnish the "power behind the signal" wherever amateur radio is found. They are outstanding in performance—low in cost.

The RCA-866 (illustrated) and 866-A are half-wave, mercury-vapor rectifier tubes that are popular for many amateur uses. The 866 has a maximum peak inverse rating of 7500 volts, while the 866-A has a rating of 10,000 volts. RCA-866—\$1.50, RCA-866-A—\$4.00.

The RCA-872 is a half-wave, mercury-vapor rectifier tube of the coated-filament type. It is a husky, high-powered rectifier, ideal for supplying that one-kilowatt rig. It has a maximum peak inverse rating of 10,000 volts. Price \$14.00.

RCA presents the Magic Key every Sunday, 2 to 3 P.M., E.S.T., on the NBC Blue Network.

FIRST IN METAL · FOREMOST IN GLASS · FINEST IN PERFORMANCE

**RCA MANUFACTURING COMPANY, INC., CAMDEN, NEW JERSEY
A SERVICE OF THE RADIO CORPORATION OF AMERICA**

GOOD ENGINEERING PRACTICE

The F. C. C. standards of good engineering practice, while intended by the commission to apply specifically to standard broadcast stations, contain recommendations that might be adopted advantageously in whole or part by stations of other classes, including amateurs. The present standards, enlarged from time to time as the state of the art improves, were designed to promote efficient station operation, as well as to safeguard operators and other persons from injury or death by electrocution.

Excerpts from the salient provisions of interest to amateurs are digested in the following paragraphs.

Protective Construction

Transmitters should be built either on racks and panels or in completely enclosed frames. The entire transmitter should be enclosed in a metal frame or grill or separated from the operating space by a barrier (or other equivalent means), all metallic parts of which are grounded.

High-powered final stages may be assembled in open frames provided the equipment is enclosed by a protective fence.

All external metallic handles and controls accessible to the operator must be adequately grounded. Tuning adjustments in circuits requiring voltages in excess of 750 must be made from the front of the panels with all access doors closed. All access doors must be provided with interlocks which will disconnect all voltages in excess of 750 when any such door is opened.

Meters having more than 1000 volts potential to ground on their movements must be protected by a cage or cover *in addition to the regular case* unless it can be shown by the manufacturer's rating that the meters will operate safely at the applied potential. No protective case is required on a plate voltmeter located at the low-voltage end of a multiplier resistor with one terminal of the meter at less than 1000 volts above ground. The commission considers it best practice to protect voltmeters subject to more than 5000 volts with suitable over-voltage protective devices

across the instrument terminals in case the winding should open.

No circuit in excess of 150 volts shall have any parts exposed to direct contact. Dead front type of switchboard construction is preferred.

Proper bleeder resistors must be installed across all condenser banks to remove any charge which may remain after the circuit is opened. All plate-supply and other high-voltage equipment must be protected to prevent injury to the operator. Commutator guards must be provided on all high-voltage motor generators and similar machines. Exposed 220-volt switching equipment is not recommended; however it is not prohibited.

The antenna, lead-in, counterpoise, etc. must be installed so as not to present a hazard. It is not considered necessary to protect the equipment in the antenna tuning house and base of the antenna with screens and interlocks if doors to the tuning house and antenna are fenced and locked at all times with keys in the possession of the operator.

Wiring and Shielding

Transmitter panels or units must be wired in accordance with standard switchboard practice, either with cabled, insulated leads or with rigid bus bar properly insulated and protected. Inter-unit wiring in the transmitter (with the exception of circuits carrying r. f.) must be installed in approved fiber conduit or metal raceways to protect it from mechanical injury.

Circuits carrying low-level r. f. between units must consist either of concentric tubing, two-wire balanced lines, or be properly shielded to prevent the pickup of modulated r. f. energy from the output circuit.

Each stage preceding the modulated stage, including the oscillator, must be adequately shielded and filtered to prevent feedback. The commission requires that the crystal chamber, together with the leads to the oscillator circuit, be *totally* shielded. Lines running between the transmitter and monitors or similar devices must be thoroughly shielded.

P. R. MALLORY & CO. INC.
MALLORY

YAXLEY

AMATEUR RADIO PRODUCTS

Perfect Portable Power for Transmitters, Receivers, PA Systems

Economical, dependable plate voltage can be obtained from a 6 volt storage battery through the use of this *perfected* vibrator type power supply. Flexible—efficient—easy to use, and available in Self Rectifying and Tube Rectifying types. In addition, Vibrapack VP-G556 is available for airplane, bus and boat service requiring operation with a 12 volt storage battery.



For Transmitter Band Switching... HamBand Switches with Ceramic Insulation

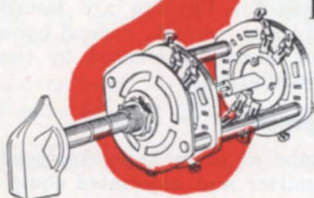

Convenient terminal arrangements, wide spacing of current carrying parts, heavy silver-plating on contacts, and low-loss magnesium silicate ceramic insulation especially designed for high frequency application . . . make band switching a reality for every amateur . . . and as easy as tuning a modern communications receiver. Mally-Yaxley 160C HamBand Switches are rated for use in transmitter plate circuits using up to 1000 Volts DC with power up to 100 watts inclusive. Your Mally-Yaxley distributor can give you complete information.

New Low Prices on Transmitting Condensers

Now Mally Transmitting Condensers are within the reach of every amateur. Made with a new type impregnating material, unlike wax or the customary oil impregnating compounds, it operates satisfactorily at temperatures that would be destructive to other types. Its high dielectric constant and insulation resistance make possible the relatively small size of these transmitting units. Available in rectangular or round can types.



Other Mally-Yaxley Products for Amateurs

Dry Electrolytic Condensers
Wet Electrolytic Condensers
Tip Jacks and Plugs
Phone Plugs
Jacks and Jack Switches

Grid Bias Cells
Vitreous Resistors
Truvolt Resistors
Precision Resistors
Rheostats
Potentiometers

Volume Controls
T & L Pads
Rotary Switches
Push Button Switches
Cable Connectors

Dial and Panel Lights
Radio Convenience Outlets
Knobs—Nuts—Washers
Dry Disc Rectifiers
Auto Radio Vibrators

P. R. MALLORY & CO. INC.
MALLORY

YAXLEY

P. R. MALLORY & CO., Inc.
INDIANAPOLIS INDIANA
Cable Address—PELMALLO

GOOD ENGINEERING PRACTICE (Continued)

Meter Specifications

All meters used in the final stage must have a minimum scale length of 2.3 inches and be accurate to two per cent of the full-scale reading. The maximum deflection must be such that the meters do not read off scale during modulation. No instrument, the accuracy of which is questionable or which has had its seal broken, should be employed.

Meters indicating plate voltage or plate current in the final r. f. stage must have a scale length of at least forty divisions. The full-scale reading must be not more than five times the minimum normal indication.

Antenna ammeters with *logarithmic* or *square law* scales should have a full-scale deflection not greater than three times the minimum normal indication. No scale division above one-third full scale (amperes) shall be greater than one-thirtieth of the full-scale reading.

Antenna ammeters with *expanded* scales should have a full-scale deflection not greater than five times the minimum normal indication. No scale division above one-fifth the full-scale reading

(amperes) should be greater than one fiftieth of the full-scale reading.

Tower Lighting and Painting

Where antenna masts and towers are high enough to constitute a hazard to aviation, they must be painted and illuminated. Each tower must be painted throughout its height with alternate bands of white and international orange (orange-yellow No. 5 of the color card supplement to the U. S. Army Q. M. C. Specifications No. 3-1) terminating with orange bands at both top and bottom. The width of the orange bands must be one-seventh of the height of the structure; the white bands, one-half the width of the orange ones. If the towers are over 250 feet high, bands should be from thirty to forty feet wide.

Specifications for lighting are issued by the Commission; details depend upon the degree of hazard presented by the particular installation.

Spare Equipment

A spare tube of every type employed in the transmitter and associated equipment must be kept on hand.

CONVERSION TABLE

Factors for conversion, alphabetically arranged

MULTIPLY	BY	TO GET	MULTIPLY	BY	TO GET
Amperes	× 1,000,000	microamperes	Micro-ohms	× .000,001	ohms
Amperes	× 1,000	milliamperes	Microvolts	× .000,001	volts
Cycles	× .000,001	megacycles	Microwatts	× .000,001	watts
Cycles	× .001	kilocycles	Micromicrofarads	× .000,000,000,001	farads
Farads	× 1,000,000,000,000	micromicrofarads	Milliamperes	× .001	amperes
Farads	× 1,000,000	microfarads	Millihenrys	× .001	henrys
Henrys	× 1,000,000	microhenrys	Millimhos	× .001	mhos
Henrys	× 1,000	millihenrys	Milliohms	× .001	ohms
Kilocycles	× 1,000	cycles	Millivolts	× .001	volts
Kilovolts	× 1,000	volts	Milliwatts	× .001	watts
Kilowatts	× 1,000	watts	Ohms	× 1,000,000	micro-ohms
Megacycles	× 1,000,000	cycles	Volts	× 1,000,000	microvolts
Mhos	× 1,000,000	micromhos	Volts	× 1,000	millivolts
Microamperes	× .000,001	amperes	Watts	× 1,000,000	microwatts
Microfarads	× .000,001	farads	Watts	× 1,000	milliwatts
Microhenrys	× .000,001	henrys	Watts	× .001	kilowatts
Micromhos	× .000,001	mhos			

GREAT CIRCLE GLOBE

If a good globe of the type supported at two points (not a single-bearing model) is remounted so that it swings on the operator's own town and its antipodes as axes, instead of the North and South Poles, the supporting arm will

give the Great Circle path to any point that the operator would wish to find. Calibration can be made in miles; and a circle drawn around the operator's location and calibrated in geometric degrees will give directions.

40-80-160 METERS

23 cycles/mc./°C

Thoroughly reliable in every respect, this medium-drift mounted crystal offers dependable frequency control at an economical cost. It is carefully manufactured, ground for high activity and accurately calibrated.

Price, 40 and 80-meter bands, ± 5 kc., \$3.35
 Price, 160-meter band ± 10 kc., \$3.35



Type BC3

BLILEY CRYSTALS

40-80 METERS

Variable Frequency

Dodging QRM is easy with this mounted low-drift crystal. Its frequency is adjustable up to 6kc. at 80 meters and up to 12kc. at 40-meters. No special circuits are required.

Price, 40-meter band, ± 15 kc. \$7.50
 Price, 80-meter band, ± 5 kc. \$7.50



Type VF1

10-20 METERS

20 cycles/mc./°C.
(20-meters)

43 cycles/mc./°C.
(10-meters)

This dependable, precision ground crystal simplifies the construction of 5, 10 and 20-meter transmitters.

Price, 14.0 to 14.4 mc., ± 15 kc. \$5.75
 Price, 14.4 to 15.0 mc., ± 30 kc. \$5.75
 Price, 28.0 to 30.0 mc., ± 50 kc. \$5.75



Type HF2

CALIBRATOR CRYSTAL UNIT

A dual-frequency mounted crystal for both 100kc. ($\pm .01\%$) and 1000kc. ($\pm .05\%$). Ideal for calibration of radio receivers, test oscillators, signal generators, etc.

Price \$7.75



Type SMC100

20-40 METERS

4 cycles/mc./°C. (Max.)

Designed after extensive research, this highly efficient crystal unit sets new standards of performance for high frequency, low-drift crystals.

Price, 7.0 to 7.3 mc., ± 5 kc. \$4.80
 Exact integral kc's. \$5.90
 Price, 14.0 to 14.4 mc., ± 15 kc. \$7.50
 Price, 14.4 to 15.0 mc., ± 30 kc. \$7.50



Type B5

CRYSTAL FILTER UNIT

No modern communications receiver is complete without a precision Bliley CFI quartz crystal filter unit. Correct design assures maximum selectivity.

Price, 456kc., 465kc. or 500kc. I.F. \$5.50
 Price, 1600kc. I.F. \$9.50



Type CFI

80-160 METERS

4 cycles/mc./°C. (Max.)

A precision low-drift crystal. Rigidly tested, it is thoroughly reliable, efficient and powerful.

Price, 80 or 160-meter band, ± 5 kc. \$4.80
 Exact integral kc's. \$5.90



Type LD2

"TRANSMITTER 1939 Design"

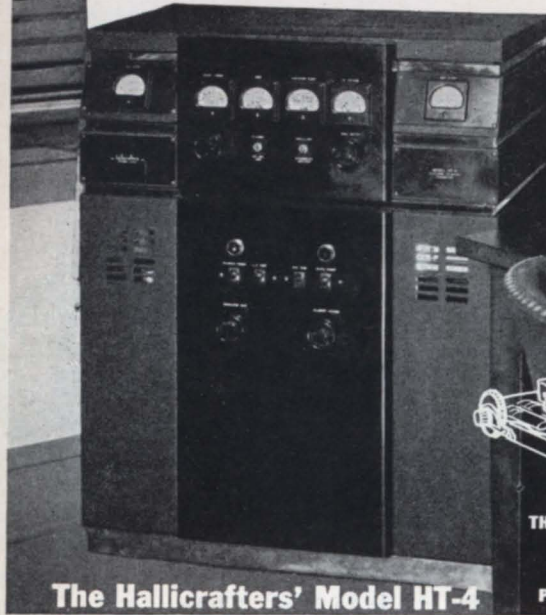

The Hallicrafters' Model HT-4

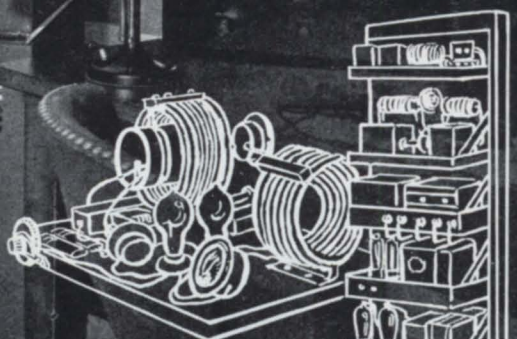

THE BREAD BOARD TRANSMITTER



PANEL AND RACK TRANSMITTER

The swift pace of amateur radio provides an interesting study in evolution, and the Model HT-4 a striking example of the development in transmitter design.

Old Timers remember the "bread board" era, when getting a transmitter to operate at all was the first consideration, and convenience and appearance received little thought, if any,—with "hay-wired" parts spread over an entire table top.

The next step in the evolution of the amateur transmitter was borrowed from the telephone exchange. To provide a standardized flexible unit construction that would permit the easy assembly of a great metropolitan exchange or a hundred line rural unit, designers of telephone equipment devised the "rack and panel." Amateur radio borrowed it, and transmitter parts left the "bread-board."

As transmitter circuits have developed in efficiency, the advantages offered by the rack and

panel construction are being nullified. Built to impractical and "clumsy" heights, it leaves much to be desired from the standpoint of appearance, not to mention operating convenience. The logical coordination of the transmitter components for the greatest efficiency is difficult if not impossible. Its open construction exposes many leads to accidental contact or short circuit.

The Model HT-4, offers a new conception of transmitter design, a distinct departure from the traditional to the functional. Here is a logical coordination of parts, with the entire R.F. section on a single plane, permitting shorter leads and a reduction of losses that greatly increase overall efficiency. The operating controls are brought within easy reach. All its parts are entirely enclosed and protected, but with ample provision for ventilation. The whole presents a finished "engineered" and planned appearance that leaves an impression of efficiency and dependability.



We present the Model HT-4 as the first of a new trend in Amateur Radio Transmitters.

(left) Model HT-4 with cover removed showing complete Top View of R.F. Section.

(right) Rear View of Model HT-4 with back panel removed. Note orderly and logical placement of components.

All Hallicrafters' Equipment sold on Liberal Time Payments.



the hallicrafters inc.

2609 Indiana Avenue, Chicago, U. S. A. • Cable Address: "HALLICRAFT," Chicago

WORLD'S LARGEST BUILDERS OF AMATEUR COMMUNICATIONS EQUIPMENT

MEASURE
the
PERFORMANCE!

Compare the values!

Offered by these
hallicrafters receivers

MODEL S-17
SUPER-SKYRIDER



Imagine a receiver that answers every amateur radio need—with 2 tuned R. F. stages, a built-in Automatic Noise Limiter, with average sensitivity better than 1 microvolt over its tuning range of 62 MC to 545 KC, bringing in everything from the 5 meter band to the top of the broadcast band, a 1000° Band Spread that separates closely crowded signals with ease—imagine all this in a single receiver and you have the Model S-17. There's nothing missing—performance, convenience, precision construction and engineering—and with all this the Model S-17 sells at an astonishingly modest price for so much real value. See the Model S-17, compare its performance, compare its cost—you'll see why it is amateur radio's most popular receiver.

\$125⁵⁰

*less speaker
less crystal*

The SKY CHAMPION

Here's a real communications receiver in every respect, with all the essential controls for good amateur reception, built with the precision workmanship and engineering that is typical of every Hallicrafters receiver. It's an 8-Tube set with pre-selection and excellent sensitivity and selectivity. Covers everything from the 10 meter band to the top of the broadcast band (44 MC to 545 KC) on 4 bands with separate Band Spread Dial that helps spread out the signal on the crowded amateur bands. The Sky Champion is one of the greatest values ever offered to the radio amateur.

All Hallicrafters Speakers available on Liberal Time Payments

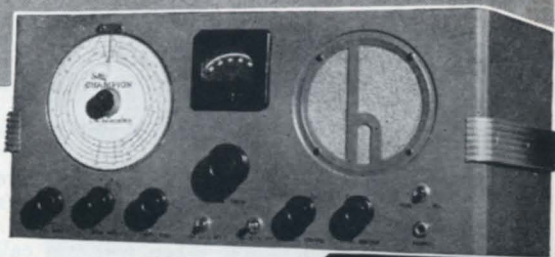

\$49⁵⁰

*Including
Speaker*

the hallicrafters inc.

2609 INDIANA AVE., CHICAGO, U. S. A.

CABLE ADDRESS: HALLICRAFT, CHICAGO

"WORLD'S LARGEST BUILDER OF AMATEUR COMMUNICATIONS EQUIPMENT"

THE "Q" SIGNALS

Abbreviation	Question	Answer
QRA	What is the name of your station?	The name of my station is
QRB	How far approximately are you from my station?	The approximate distance between our stations is nautical miles (or kilometers).
QRC	What company (or Government Administration) settles the accounts for your station?	The accounts for my station are settled by the company (or by the Government Administration of).
QRD	Where are you bound and where are you from?	I am bound for from
QRE	Will you tell me my exact frequency (wavelength) in kc/s (or m)?	Your exact frequency (wavelength) is kc/s (or m).
QRH	Does my frequency (wavelength) vary?	Your frequency (wavelength) varies.
QRI	Is my note good?	Your note varies.
QRJ	Do you receive me badly? Are my signals weak?	I cannot receive you. Your signals are too weak.
QRK	Do you receive me well? Are my signals good?	I receive you well. Your signals are good.
QRL	Are you busy?	I am busy (or I am busy with). Please do not interfere.
QRM	Are you being interfered with?	I am being interfered with.
QRN	Are you troubled by atmospherics?	I am troubled by atmospherics.
QRO	Shall I increase power?	Increase power.
QRP	Shall I decrease power?	Decrease power.
QRQ	Shall I send faster?	Send faster (..... words per minute).
QRR		<i>Amateur "SOS" or distress call (U.S.A.). Use only in serious emergency.</i>
QRS	Shall I send more slowly?	Send more slowly (..... words per minute).
QRT	Shall I stop sending?	Stop sending.
QRU	Have you anything for me?	I have nothing for you.
QRV	Are you ready?	I am ready.
QRW	Shall I tell that you are calling him on kc/s (or m)?	Please tell that I am calling him on kc/s (or m).
QRX	Shall I wait? When will you call me again?	Wait (or wait until I have finished communicating with) I will call you at o'clock (or immediately).
QRY	What is my turn?	Your turn is No. (or according to any other method of arranging it).
QRZ	Who is calling me?	You are being called by
QSA	What is the strength of my signals (1 to 5)?	The strength of your signals is (1 to 5).
QSB	Does the strength of my signals vary?	The strength of your signals varies.



A Complete Line of Condensers

Backed by 27 Years Experience

VERY HAMMARLUND product embodies over a quarter of a century of experience in precision manufacturing. Whether you are building a simple one-tube receiver or a multi-stage 1 KW. transmitter you will be safe in using Hammarlund components.

"MC" and "HF" midget condensers are used extensively by amateurs and experimenters in receivers both for high and ultra-high frequencies and also in low power transmitters and exciter units. Many laboratories specify these precision condensers in the design of commercial equipment. Outstanding features are: Isolantite insulation, cadmium plated soldered brass plates, silver plated Beryllium contacts and universal mounting.

"MTC" and "N-10" are companion units designed for low and medium power transmitters. "MTC" is available in a wide range of capacities and in peak voltages from 1000 to 5000 with either single or dual stator. Type "N" neutralizing condensers are made in three ranges. "N-10," the smallest, is for use with medium-power high efficiency tubes. "N-15" is for high-power tubes, and "N-20" is for high-power tubes with rather large inter-electrode capacities.

"TC" is a new series of moderately priced transmitting condensers for transmitters up to 1 KW. input. These, like the "MTC", feature silver plated Beryllium contacts, Isolantite insulation, non-magnetic rotor assembly, special cushioned bearing which eliminates shaft binding and twisting resulting in smooth electrical and mechanical operation. There are 29 different types in the "TC" line with voltage ratings from 2000 to 7500 and in capacities suitable for every conceivable amateur and laboratory application.

WRITE FOR
GENERAL
CATALOG

Our general catalog contains technical data on these and many other items of interest to the ham and experimenter. Write Dept. RH-1 for your copy.

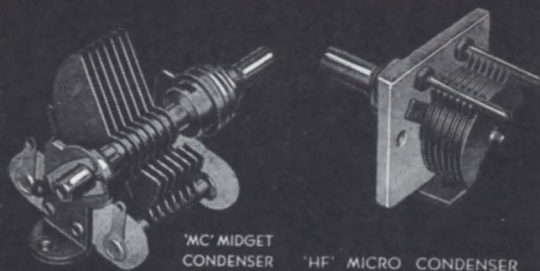

'MC' MIDGET CONDENSER 'HF' MICRO CONDENSER

"MC" and "HF" condensers are ideal for receivers, low power transmitters and exciters.

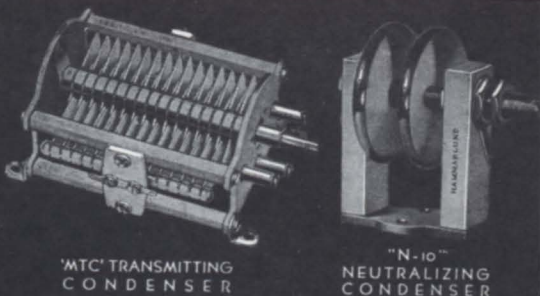

'MTC' TRANSMITTING CONDENSER "N-10" NEUTRALIZING CONDENSER

"MTC" and "N-10" for medium power.
"TC" and "TCD" for rigs up to 1 KW.

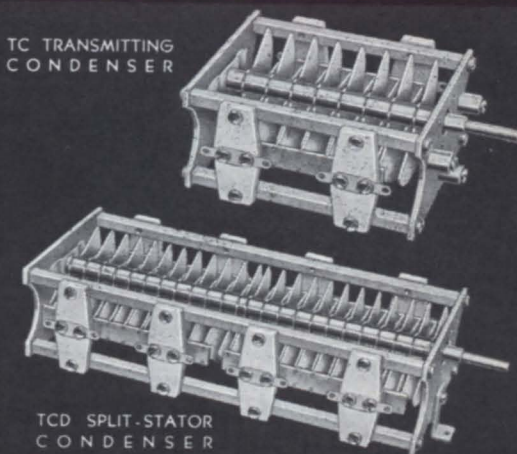

TC TRANSMITTING CONDENSER

TCD SPLIT-STATOR CONDENSER

HAMMARLUND MFG. CO., INC.

424 W. 33rd St., New York City

CANADIAN OFFICE: 41 West Av. No., Hamilton, Ont.

The "Q" Signals (Continued)

QSD	Is my keying correct; are my signals distinct?	Your keying is incorrect; your signals are bad.
QSG	Shall I send telegrams (or one telegram) at a time?	Send telegrams (or one telegram) at a time.
QSI	What is the charge per word including your internal telegraph charge?	The charge per word for is francs, including my internal telegraph charge.
QSK	Shall I continue with the transmission of all my traffic, I can hear you through my signals?	Continue with the transmission of all your traffic, I will interrupt you if necessary.
QSL	Can you give me acknowledgment of receipt?	I give you acknowledgment of receipt.
QSM	Shall I repeat the last telegram I sent you?	Repeat the last telegram you have sent me.
QSO	Can you communicate with direct (or through the medium of)?	I can communicate with direct (or through the medium of).
QSP	Will you retransmit to free of charge?	I will retransmit to free of charge.
QSR	Has the distress call received from been cleared?	The distress call received from has been cleared by
QSU	Shall I send (or reply) on kc/s (or m) and/or on waves of Type A1, A2, A3, or B?	Send (or reply) on kc/s (or m) and/or on waves of Type A1, A2, A3, or B.
QSV	Shall I send a series of VVV?	Send a series of VVV
QSW	Will you send on kc/s (or m) and/or on waves of Type A1, A2, A3 or B?	I am going to send (or I will send) on kc/s (or m) and/or on waves of Type A1, A2, A3 or B.
QSX	Will you listen for (call sign) on kc/s (or m)?	I am listening for (call sign) on kc/s (or m).
QSY	Shall I change to transmission on kc/s (or m) without changing the type of wave? or Shall I change to transmission on another wave?	Change to transmission on kc/s (or m) without changing the type of wave. Change to transmission on another wave.
QSZ	Shall I send each word or group twice?	Send each word or group twice.
QTA	Shall I cancel telegram No. as if it had not been sent?	Cancel telegram No. as if it had not been sent.
QTB	Do you agree with my number of words?	I do not agree with your number of words; I will repeat the first letter of each word and the first figure of each number.
QTC	How many telegrams have you to send?	I have telegrams for you (or for).
QTE	What is my true bearing in relation to you? or What is my true bearing in relation to (call sign)? or	Your true bearing in relation to me is degrees or Your true bearing in relation to (call sign) is degrees at (time) or

Send for Your Free Copy of

**STANCOR
HAMANUAL**
(Supplementary Form)

1939 EDITION

... AND UP-TO-THE-MINUTE SUPPLEMENTS

STANDARD Transformer Corporation, manufacturers of famous STANCOR products, invites you to send for a FREE copy of the new 8-page transformer catalog containing complete transformer requirements for every transmitter circuit, tabulations and listings.

Supplements will be issued from time to time, containing the latest transmitter circuit changes or developments and these supplements will be sent free to those who have received the 1939 catalog. This means that the STANCOR catalog will be up to the minute always—truly current.

Just mail a postal card, saying: "Put me down for the Free Stancor Hamanual and periodic supplements".



STANDARD TRANSFORMER CORPORATION

1500 NORTH HALSTED STREET . . . CHICAGO

REFINE and IMPROVE...

In these two words RADIO MFG. ENGINEERS, INC., have given to the radio communication field the best possible receivers and accessory units which are now being used very universally. In our business of satisfying communication needs there are no yearly models. The basic design of a good receiver—the coils—the frame—the valuable features—are standard.

This does not mean that our laboratory lags behind. The research and development program goes on. Fine suggestions come to us periodically from radio men in the field.

Literature always sent on request

RME

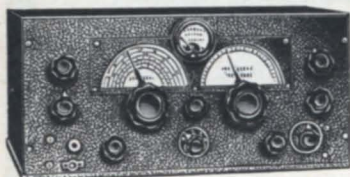

circuit, and most everything you would want and need for satisfactory DX results—the RME-69 is the answer!

The RME-69, with its great flexibility in adaptations to special needs, is being built as before. With or without manual noise suppressor—in standard or battery model—for special frequency coverage in the low or ultra-high ranges—for relay rack mounting—for any special requirements in your station—look to the RME-69 for complete satisfaction. When searching for a receiver which will perform under all conditions—one which will give you full vision tuning, band spread, variable phasing crystal filter

RME

THE DB-20 PRESELECTOR AND R. F. AMPLIFIER

A two-stage, three-circuit, self-powered, R.F. Amplifier unit which may be used ahead of any good superheterodyne receiver and *outperform* your present performance. With antenna changeover switch incorporated as standard, supplied with three tubes, frequency range 550 to 32,000 KC in six bands, A.C. or battery or combination supply optional, this unit has found acceptance in thousands of radio stations.



RME

THE 510X FREQUENCY EXPANDER

The latest unit to be introduced is this Expander which, when used with good stable superheterodyne receivers, will permit exceptional results in the range 28 to 70 megacycles. A good image rejector, since the R.F. stage of the receiver is definitely set at 10 MC, a three band scale (approximately twenty-one inches of scale travel) equipped with antenna changeover switch, self contained power supply, built on cast aluminum frame. This unit will *open up* five meter operation and give the radio amateurs something new to shoot at. Already users are reporting a "Worked all districts on five meters."



RADIO MANUFACTURING ENGINEERS, Inc.
PEORIA, ILLINOIS, U. S. A.

THE RME-70

A new model
with new features
at a lower price

This is what
you will find
in the RME-70

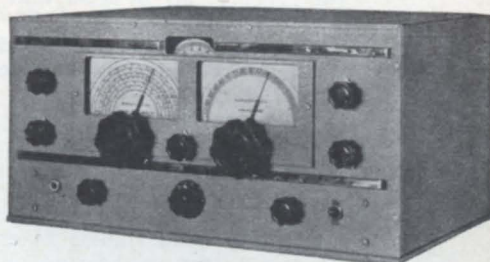

1. New Illuminated DB-R meter
2. Three new iron core IF transformers
3. Improved automatic Noise Suppressor
4. Variable phasing crystal control circuit
5. Break-in relay control
6. Frequency range from 550 to 32,000 KC
7. Extreme selectivity
8. Streamlined cabinet design
9. Controls designated with lettering
10. Total complement of eleven tubes
11. One stage of amplification
12. Sturdy construction, detailed engineering and exceptional quality throughout.

The same sturdy construction, the same fidelity to detail in engineering, the same high quality workmanship that has always been characteristic of RME products will be found in this new receiver.

The speaker housing also has been re-designed to match the receiver cabinet design.

Ask us for a comprehensive folder on all of the units.

The RME-70 is a ONE TYPE, ONE MODEL receiver. NO variations are obtainable other than the combination and the gray or black crinkle finish. In order to offer to the radio field an instrument of this type and quality at a lower price it was necessary to standardize on the one unit and eliminate variable adaptations. If any alterations to the RME receiver are desired you will find your requirements met in the RME-69 series of instruments.

THE DB-20-70

The two stage R.F. amplifier and preselector may be ordered to match the outward appearance of the RME-70. Frequency Range from 550 to 32,000 KC. Net price, with tubes and changeover switch, black or gray finish, \$42.60.

THE 510X-70

This frequency expander is available in the front trim to match the RME-70 receiver at no additional cost. Frequency coverage 28 to 70 megacycles. Very effective in image suppression. Net price, with tubes and changeover switch, black or gray finish \$45.10.

THE COMBINATION

The RME-70 and DB-20-70 are also built into one cabinet, either black or gray finish. This combination makes one of the finest and most up-to-date units for any amateur radio station. Literature available for the asking.

RADIO MANUFACTURING ENGINEERS, Inc.
PEORIA, ILLINOIS, U. S. A.

The "Q" Signals (Continued)

	What is the true bearing of (call sign) in relation to (call sign)?	The true bearing of (call sign) in relation to (call sign) is degrees at (time).
QTF	Will you give me the position of my station according to the bearings taken by the direction-finding stations which you control?	The position of your station according to the bearings taken by the direction-finding stations which I control is latitude longitude.
QTC	Will you send your call sign for fifty seconds followed by a dash of ten seconds on kc/s (or m) in order that I may take your bearing?	I will send my call sign for fifty seconds followed by a dash of ten seconds on kc/s (or m) in order that you may take my bearing.
QTH	What is your position in latitude and longitude (or by any other way of showing it)?	My position is latitude longitude (or by any other way of showing it).
QTI	What is your true course?	My true course is degrees.
QTI	What is your speed?	My speed is knots (or kilometers) per hour.
QTM	Send radioelectric signals and submarine sound signals to enable me to fix my bearing and my distance.	I will send radioelectric signals and submarine sound signals to enable you to fix your bearing and your distance.
QTO	Have you left dock (or port)?	I have just left dock (or port).
QTP	Are you going to enter dock (or port)?	I am going to enter dock (or port).
QTQ	Can you communicate with my station by means of the International Code of Signals?	I am going to communicate with your station by means of the International Code of Signals.
QTR	What is the exact time?	The exact time is
QTU	What are the hours during which your station is open?	My station is open from to
QUA	Have you news of (call sign of the mobile station)?	Here is news of (call sign of the mobile station).
QUB	Can you give me in this order, information concerning: visibility, height of clouds, ground wind for (place of observation)?	Here is the information requested
QUC	What is the last message received by you from (call sign of the mobile station)?	The last message received by me from (call sign of the mobile station) is
QUD	Have you received the urgency signal sent by (call sign of the mobile station)?	I have received the urgency signal sent by (call sign of the mobile station) at (time).
QUF	Have you received the distress signal sent by (call sign of the mobile station)?	I have received the distress signal sent by (call sign of the mobile station) at (time).
QUG	Are you being forced to alight in the sea (or to land)?	I am forced to alight (or land) at (place).
QUH	Will you indicate the present barometric pressure at sea level?	The present barometric pressure at sea level is (units).
QUJ	Will you indicate the true course for me to follow, with no wind, to make for you?	The true course for you to follow, with no wind, to make for me is degrees at (time).

BUILDING INVISIBLE

GAMMATRON QUALITY

Many of the elements responsible for the phenomenal performance and long length of service of GAMMATRON tubes are invisible. The manufacturing technique, engineering skill and years of successful experience in the amateur, broadcast and commercial fields are qualities which are not readily seen in the finished product, but are immediately apparent when the tube is placed in service. There is a GAMMATRON that will do your transmitting job at lower cost per Q.S.O. and with greater ease. See your dealer or write for data on the full GAMMATRON line . . . from the 54 to the 3054.

ON THE VACUUM PUMP THE 654 GAMMATRON

This photograph shows invisible quality being built into the 654 Gammatron. To properly condition the tantalum plate it is being run at 8 to 10 times its normal dissipation rating. Through this operation gas is completely eliminated, thus preventing failure due to overload.

HEINTZ AND KAUFMAN
SOUTH SAN FRANCISCO CALIFORNIA U.S.A.

R. M. A. COLOR CODE

For Fixed Condensers, Unit: Micro-Microfarads

For Resistors, Unit: Ohms

FIRST DOT	SECOND DOT	THIRD DOT	
Black	0	Black	0
Brown	1	Brown	00
Red	2	Red	000
Orange	3	Orange	0000
Yellow	4	Yellow	00000
Green	5	Green	000000
Blue	6	Blue	0000000
Purple	7	Purple	00000000
Gray	8	Gray	000000000
White	9	White	0000000000

BODY COLOR	END COLOR	DOT COLOR	
Black	0	Black	0
Brown	1	Brown	00
Red	2	Red	000
Orange	3	Orange	0000
Yellow	4	Yellow	00000
Green	5	Green	000000
Blue	6	Blue	0000000
Purple	7	Purple	00000000
Gray	8	Gray	000000000
White	9	White	0000000000

RADIO SYMBOLS USED IN CIRCUIT DIAGRAMS

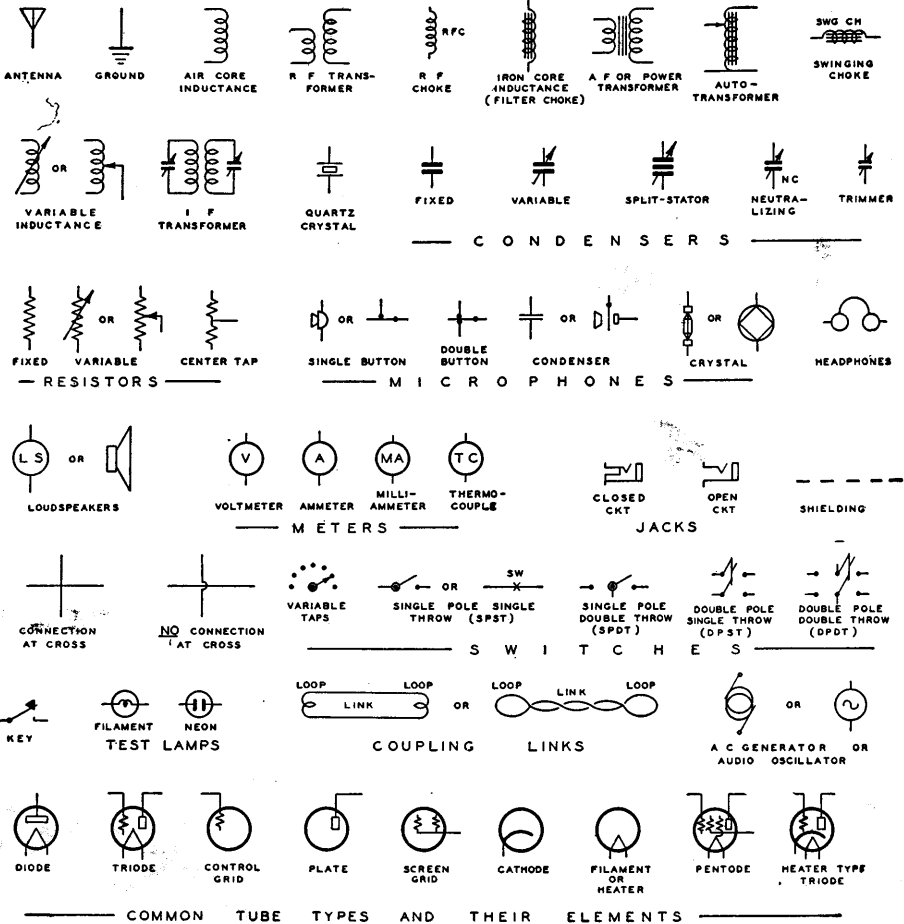

SOLAR

TRANSMITTING CAPACITORS

SOLAR

TRANSOIL TRANSMITTING CAPACITORS OIL IMPREGNATED—OIL FILLED

TYPE XT—TUBULAR Oil Impregnated—Metal Case

Cat. No.	Cap. Mfd.	Operating Volts D.C.	Size Inches	List Price
XT-0005	.0005	1600	1/2 x 1 1/2	\$.60
XT-001	.001	1600	1/2 x 1 1/2	.60
XT-002	.002	1600	1/2 x 1 1/2	.60
XT-003	.003	1600	1/2 x 1 1/2	.60
XT-004	.004	1600	1/2 x 1 1/2	.60
XT-005	.005	1600	1/2 x 1 1/2	.60
XT-007	.007	1600	1/2 x 1 1/2	.60
XT-01	.01	1600	3/8 x 2 1/8	.60
XT-02	.02	1600	3/8 x 2 1/8	.65
XT-05	.05	1600	1/8 x 2 1/8	.80
XT-1	.1	1600	1 1/8 x 2 1/4	.90
XT-101	.01	1000	1/8 x 1 3/4	.50
XT-102	.02	1000	1/8 x 1 3/4	.55
XT-105	.05	1000	1/8 x 2 1/8	.65
XT-11	.1	1000	1/8 x 2 1/8	.80

TYPE XD—DRAWN SHELL CAN Oil Impregnated—Oil Filled

XD-61	.1	600	1 1/8 x 1 x 3/4	1.45
XD-625	.25	600	1 1/8 x 1 x 3/4	1.70
XD-65	.5	600	2 x 1 3/4 x 1	1.95
XD-11	.1	1000	1 1/8 x 1 x 3/4	1.80
XD-125	.25	1000	2 x 1 3/4 x 1	2.20

TYPE XC—ROUND INVERTED AL. CAN Oil Impregnated—Oil Filled

XC-61	1	600	1 1/2 x 3	2.00
XC-62	2	600	1 1/2 x 3	2.25
XC-64	4	600	1 1/2 x 4 3/8	3.00
XC-11	1	1000	1 1/2 x 3	2.25
XC-12	2	1000	1 1/2 x 4 3/8	2.75
XC-155	.5	1500	1 1/2 x 3	2.75
XC-151	1	1500	1 1/2 x 4 3/8	3.00

TYPE XL—RECTANGULAR CANS Oil Impregnated—Oil Filled

Cat. No.	Cap. Mfd.	Size Inches	List Price
600 D.C. Oper. Volts—440 R.M.S. Rect. A.C.			
XL-6-1	1	2 1/4 x 1 3/4 x 1	\$2.75
XL-6-2	2	2 3/8 x 1 3/4 x 1	3.50
XL-6-4	4	3 5/8 x 2 1/2 x 1 3/8	4.50
1000 D.C. Oper. Volts—660 R.M.S. Rect. A.C.			
XL-10-05	.5	2 1/2 x 1 3/4 x 1	2.15
XL-10-1	1	2 3/8 x 1 3/4 x 1	3.00
XL-10-2	2	4 x 1 3/4 x 1	4.00
XL-10-4	4	4 3/4 x 2 1/2 x 1 3/8	5.00
1500 D.C. Oper. Volts—1000 R.M.S. Rect. A.C.			
XL-15-1	1	4 x 1 3/4 x 1	3.50
XL-15-2	2	4 3/4 x 2 1/2 x 1 3/8	5.00
XL-15-4	4	4 3/4 x 3 3/4 x 1 1/2	7.00
2000 D.C. Oper. Volts—1500 R.M.S. Rect. A.C.			
XL-20-01	.1	2 3/8 x 1 3/4 x 1	3.25
XL-20-025	.25	2 3/8 x 1 3/4 x 1	3.75
XL-20-05	.5	2 7/8 x 1 3/4 x 1	4.00
XL-20-1	1	3 5/8 x 2 1/2 x 1 3/8	4.50
XL-20-2	2	4 3/8 x 3 3/4 x 1 1/2	5.50
XL-20-4	4	4 3/8 x 3 3/4 x 2 1/4	9.00
2500 D.C. Oper. Volts—1800 R.M.S. Rect. A.C.			
XL-25-1	1	4 3/8 x 3 3/4 x 1 1/4	8.00
XL-25-2	2	4 3/8 x 3 3/4 x 2 1/4	13.00
3000 D.C. Oper. Volts—2200 R.M.S. Rect. A.C.			
XL-30-01	.1	2 7/8 x 1 3/4 x 1	8.00
XL-30-025	.25	3 5/8 x 2 1/2 x 1 3/8	8.50
XL-30-05	.5	4 3/8 x 3 3/4 x 1 1/2	9.00
XL-30-1	1	4 3/8 x 3 3/4 x 2 1/4	15.00
XL-30-2	2	4 3/8 x 3 3/4 x 3 3/8	22.00
4000 D.C. Oper. Volts—2800 R.M.S. Rect. A.C.			
XL-40-01	.1	3 5/8 x 2 1/2 x 1 3/8	13.00
XL-40-025	.25	4 3/8 x 3 3/4 x 1 1/2	15.00
XL-40-05	.5	4 3/8 x 3 3/4 x 2 1/4	18.00
5000 D.C. Oper. Volts—3500 R.M.S. Rect. A.C.			
XL-50-01	.1	4 3/8 x 2 1/2 x 1 3/8	17.00
XL-50-025	.25	4 3/8 x 3 3/4 x 1 1/2	18.00
XL-50-05	.5	4 3/8 x 3 3/4 x 2 1/4	20.00



TYPE XL



TYPE XD



TYPE XC



TYPE XT

SOLAREX TRANSMITTING CAPACITORS

OIL IMPREGNATED
WAX FILLED

TYPE X—RECTANGULAR CANS

Cat. No.	Cap. Mfd.	D.C. Oper. Volts	D.C. Volts Flash Test	Size Inches	List Price
X-101	1	1000	2000	3 x 2 7/8 x 1 1/2	\$1.85
X-102	2	1000	2000	4 5/8 x 2 7/8 x 1 1/2	2.50
X-104	4	1000	2000	4 5/8 x 3 7/8 x 2 1/8	3.35
X-151	1	1500	3000	4 5/8 x 2 7/8 x 1 1/2	2.40
X-152	2	1500	3000	4 5/8 x 3 7/8 x 2 1/8	3.35
X-154	4	1500	3000	4 5/8 x 3 7/8 x 2 7/8	5.40
X-201	1	2000	4000	4 5/8 x 3 7/8 x 2 7/8	2.90
X-202	2	2000	4000	4 5/8 x 3 7/8 x 2 7/8	4.10
X-204	4	2000	4000	6 x 3 7/8 x 2 7/8	7.75
X-301	1	3000	6000	6 x 3 7/8 x 2 7/8	4.15
X-302	2	3000	6000	6 x 4 1/4 x 2 7/8	8.25



TYPE XB MICA TRANSMITTING CAPACITORS MOLDED IN LOW-LOSS BAKELITE—WITH WIRE LEADS

Cat. No.	Cap. Mfd.	List Price	Cat. No.	Cap. Mfd.	List Price
XB-2-31	.0001	\$.70	XB-3-31	.0001	\$1.00
XB-2-325	.00025	.75	XB-3-325	.00025	1.05
XB-2-35	.0005	.80	XB-3-35	.0005	1.25
XB-2-21	.001	.95	XB-3-21	.001	1.50
XB-2-22	.002	1.25	XB-3-215	.0015	1.90
XB-2-24	.004*	1.50	XB-3-22	.002*	2.00
XB-2-25	.005*	1.75	XB-3-24	.004*	2.50
XB-2-11	.01*	2.50	XB-3-25	.005*	2.50
XB-2-115	.015*	3.00	XB-3-25	.008*	3.00

Size 1 1/2 x 3/4 x 3/8 inches except those marked * are 2 x 1 x 3/8 inches.

Write for Catalog 2-X listing complete lines

SOLAR MANUFACTURING CORP
599-601 Broadway, New York, N. Y.

Be Right with OHMITE

NEW—*Vacuum Type* DUMMY ANTENNA RESISTOR * MODEL D-100



List Price . . . \$5.50
PATENTS PENDING

Now—a simple, accurate way to check the R. F. power and output of your transmitter, tune up for peak operating efficiency and avoid creating interference during tuning-up and adjustment. * Built like a vacuum-tube, with four-prong base. Mounts in standard tube socket. * Power easily determined from R. F. ammeter reading. * 73 ohm value—to match concentric and twisted pair lines. Available also in higher resistances. * 100 watt rating. Easily grouped for increased power capacity or other required resistances. * Unique non-inductive, non-capacitive design.

CENTER-TAPPED RESISTORS

Especially designed for use across tube filaments to provide an electrical center for the grid and plate returns. Center tap accurate to plus or minus 1%. Available in Wirewatt (1 watt) and Brown Devil (10 watt) units, in resistances from 10 to 200 ohms.

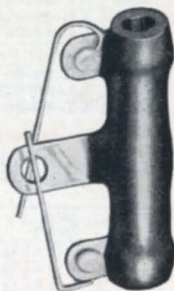

R. F. PLATE CHOKES

High frequency solenoid chokes designed to avoid either fundamental or harmonic resonance in the amateur bands. Single-layer wound on low power factor steatite cores with non-magnetic mounting brackets. Moisture-proof. Built to carry A THOUSAND MA. 4 stock sizes for 5 to 160 meter bands. Details in Bulletin 106.



GET the extra-dependability of these sturdy time-proved Ohmite Resistance Units in Your rig. Their long record of faithful, trouble-free service in countless installations—their ability to stand up under shock and vibration, heat and humidity—their world-wide adoption as standard equipment by discriminating designers and manufacturers of amateur and commercial transmitters and receivers—have proved their complete reliability and economy.

* *Ohmite Vitreous Enamel is unexcelled as a protective and bonding covering for power rheostats and resistors.*

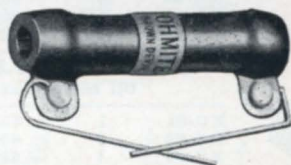

POPULAR BROWN DEVILS

There's good reason for the world-wide popularity of Ohmite "Brown Devil" Resistors. They're tough, extra-sturdy units—built right, sealed tight and permanently protected by Ohmite Vitreous Enamel. 10 and 20 watt sizes, in resistances from 1 to 100,000 ohms.



R. F. POWER LINE CHOKES

Just the thing to keep R. F. currents from going out over the power line, lessen interference with BCL receivers. Also to prevent high frequency and R. F. interference from coming in to the receiver. 3 stock sizes, rated at 5, 10, and 20 amperes. Consists of two chokes wound on a single core. Details in Bulletin 105.

SEND FOR YOUR FREE COPY OF NEW CATALOG 17

RHEOSTATS * RESISTORS * SWITCHES * CHOKES

Vitreous-Enameled RHEOSTATS



These are the rheostats used by amateurs and broadcast stations alike to keep power tube filaments at rated value all the time—*increase tube life—get peak efficiency.* Time-proved Ohmite all-porcelain vitreous-enameled construction and metal-graphite contact assure per-

manently smooth, safe, exact control. Available in 25, 50, 75, 100, 150, 225, 300, 500, and 1,000 watt sizes, for all tubes and transmitters. (Underwriters' Laboratories Listed).

OHMITE BAND-SWITCH

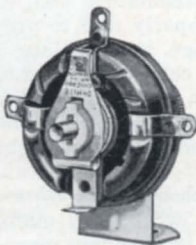

A flick-of-the-wrist on the knob of this popular Ohmite Band-Change-Switch gives you instant, easy change from one frequency to another, with really low-loss efficiency. Band changing may be provided in all stages of the transmitter, and "ganged" for complete front-of-panel control. Can be used in rigs up to 1 K.W. rating.

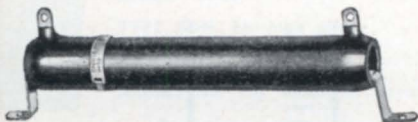

FIXED RESISTORS

These are the same dependable Ohmite vitreous-enameled resistors that are almost universally used by eminent designers and manufacturers of amateur and commercial transmitters and receivers. Available in 25, 50, 100, 160, and 200 watt stock sizes, in resistances from 5 to 250,000 ohms.

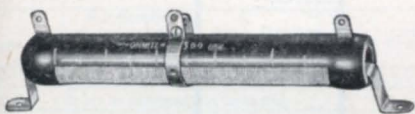

ADJUSTABLE DIVIDOHMS

Mighty handy resistors to have around when you need a change of resistor value or a replacement in a hurry. You can quickly adjust the Dividohms to the exact resistance you want and put on one or more taps wherever needed. Patented percentage of resistance scale. 7 ratings from 10 to 200 watts. Resistances up to 100,000 ohms.

Ask Your Jobber for the Ohmite parts you need, or Write today for Catalog 17.

NEW—Hermetically Sealed PRECISION RESISTORS



Now—Perfect protection against humidity, salt air and other severe atmospheric conditions. These new precision units are pie-wound and enclosed in strong evacuated glass tubes with the terminals emerging through vacuum-type glass seals. Ideal for laboratory and test equipment as well as all other applications, particularly in industrial, coastal, marine and tropical locations. Non-inductive winding. Resistance 0.1 ohm to 2.5 megohms. 1 watt rating—1% accurate (or closer tolerances when required.) Provided with soldering lugs and wire terminals or with tube base. Write for further information.

OHMITE

OHMITE MANUFACTURING CO.
4858 FLOURNOY STREET
CHICAGO, U.S.A. • Cable "Ohmiteco"

RADIO DATA CHARTS

Radio data charts provide designers of amateur radio equipment with a ready and convenient means of solving problems without having recourse to complicated formulas and mathematics.

To use the chart properly and to prevent disfiguring the page, simply place a piece of tracing paper, celluloid or waxed paper over the scales, then, the index line which intersects the scales may be drawn with a hard pencil and a straight edge.

The first chart, which is a *logarithmic alignment nomogram*, will solve many problems encountered in ordinary practice.

To find the voltage drop for a certain bias for a self-biased tube, add three ciphers to the value desired, seek this value on scale A; next, search on the B

scale for the value which corresponds to the cathode current (this will be the same as the plate current in the case of a triode; the sum of the plate and screen currents in the case of a tetrode). Now, drawing a line between these two points will intersect a point on C; this corresponds to the ohmage. Hence, a resistance required to produce 9-volts bias for a triode which operates at 3-ma. plate current is: on the A scale, 9 plus three ciphers equals 9000; on the B scale 3 ma. The ohmage 3000, is found on C.

Wattage or Heat Capacity in Resistors

To find the power in watts dissipated by a certain resistor when ohmage and

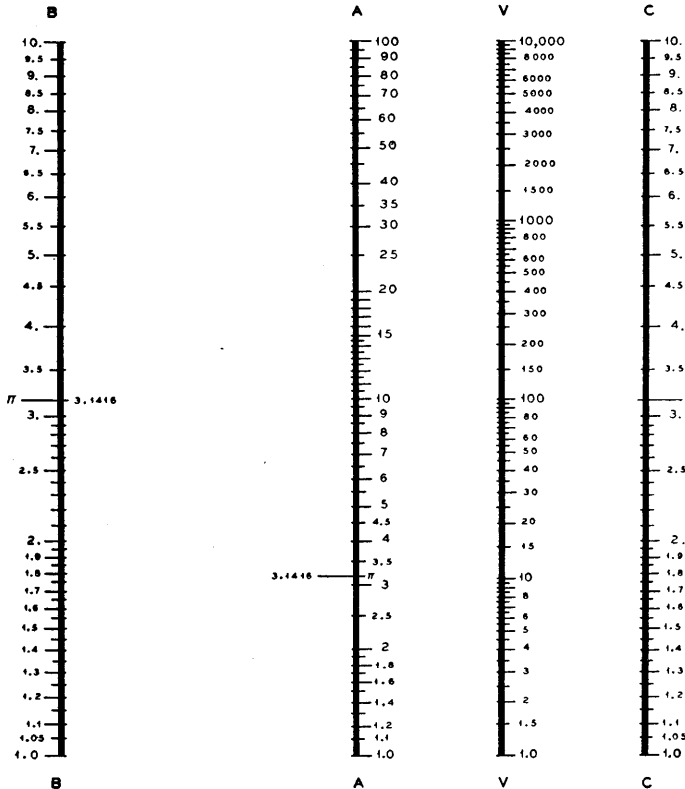

RADIO HANDBOOK LOGARITHMIC ALIGNMENT NOMOGRAM.

CARDWELLS *for every purpose*

TYPE "P" LIGHT WEIGHT CONDENSER

FOR COMMERCIAL AND AMATEUR HIGH POWER TRANSMITTERS

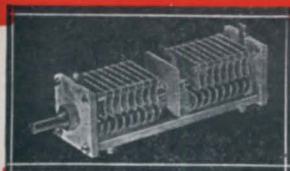

★ Trim-Air MIDGET DUAL
Singles and duals for receivers, exciters and L.P. Transmitters.

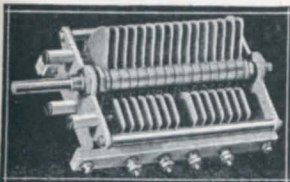

★ Midway Featherweight
Builder's choice for buffer stages—medium power finals.

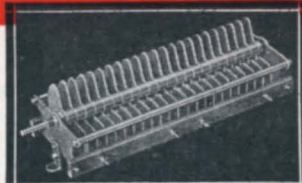

★ "X" TYPE
Transmitting Condensers
Airgaps to .200"—single and dual sections—all capacities.

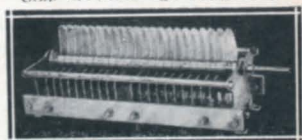

★ "T" TYPE
High Power Condensers
Airgaps to .500"—For complete listing, send for Catalog No. 40.

GENERAL SPECIFICATIONS ON "P" TYPE CARDWELLS

END PLATES—Stamped and folded 1/8" aluminum 7 1/2" square, satin finish. MOUNTING—On any side. ROTOR CONTACTS—Heavy disc double finger wipers on each end of condenser. INSULATION—High frequency G. E. mycalex. No metal tie rods. ROTOR PLATES—.0625" thick, 6 3/4" diameter, buffed and polished aluminum.

DISC TYPE NEUTRALIZERS



Type ADN, capacity range .5-4 mmf.
List \$3.00
Dealers' Price 1.80

TYPE BDN, for high power.
Capacity 2-12 mmf.
List \$5.00
Dealers' Price 3.00
Alsimag No. 196 insulation throughout.

Satin finish aluminum—fine screw adjustment, no wobble. Knurled thumb nut for easy locking—nickel silver bearing.

H. F. NEUTRALIZING CONDENSERS

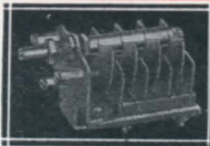

High frequency neutralizers for low capacity tubes. Mycalex insulation; heavy buffed plates with rounded edges. 180 degree rotation permits calibration and reset.

NA-16-NS

Type	Max. Cap.	Min. Cap.	Nr. Plates	Air Gap	Depth Back Panel	List Price	Dealers Price
NA-4-NS	4	2.5	2	adj.	1 3/8"	\$3.60	\$2.16
NA-6-NS	6	4	3	.218"	1 3/16"	3.60	2.16
NA-10-NS	11	6	6	.218"	2 1/8"	4.50	2.70
NA-16-NS	16	7	8	.218"	2 9/16"	5.00	3.00
NA-12-ND*	12	6	7	.218"	5 25/32"	15.00	9.00

* Gapped neutralizer with insulated coupling; information given in per section.

PLUG-IN FIXED CONDENSERS

TYPE "J" PLUG-IN FIXED AIR CONDENSERS for boosting a tank circuit designed for 20 and 40 meters to 80 and 160. Just plug-in proper "J" unit into Jack Base and load tank to proper "Q" for the lower frequencies.



Type	Capacity mmfds.	Air-gap	Length	List	Dealers Price
JCO-50-OS	50	.250"	5 3/8"	\$5.50	\$3.30
JCO-25-OS	25	.250"	3 3/4"	4.00	2.40
JD-80-OS	80	.125"	4"	5.50	3.30
JD-50-OS	50	.125"	3 3/16"	4.00	2.40
JD-25-OS	25	.125"	2 1/2"	2.80	1.68
JR-750-OS	750	.030"	4"	8.80	5.28

All "J" types are 2 1/4 inches square. TYPE JB—Jack Base for "J" fixed units. Alsimag 196—2 3/8" x 2 3/8" x 1/4". Complete with mtg. posts, screws and nuts, list \$1.00 Dealers' Price..... \$.60

ULTRA HIGH FREQUENCY DUALS

FOR 5 AND 10 METER TRANSMITTERS AND DIATHERMY MACHINES

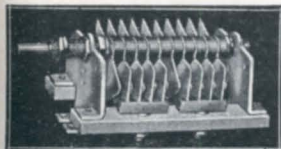

NP-35-ND

Widely used for ultra H. F. power oscillators and amplifiers; 5 and 2 1/2 meter radio transmitters, and 6 meter diathermy sets. No closed metallic loops—lowest losses. Insulation isolantite.

Type	Per Section			Air Gap	Insulation	Depth Back Panel	List Price	Dealers Price
	Mx. Cap.	Min. Cap.	Nr. Pfts.					
NP-35-ND	35	5	9	.084"	Isolantite	4 1/8"	\$6.00	\$3.60
NP-35-DD	Same as above except unbuffed						5.35	3.21

CARDWELL FLEXIBLE COUPLINGS



Type "A"

TYPE A—Fits all 1/4" shafts. Has isolantite insulation with new type nickel plated phosphor bronze springs and reversed brass hubs. Minimum space required. Maximum flexibility with no back lash. A real improvement over existing types. Overall diameter 1 1/2". Overall width outside hub-to-hub 5/8". Packed in standard cartons of one dozen. List price \$.60 each Dealers' Price \$.36 each

Type B is the same as type A except that the hubs are reversed to give maximum flashover. Price same as "A".



Type "E"

TYPE "ENF"—Lo-Flex rigid insulated coupling 1/4" shafts only —10,000 V., 1 1/2" iso. disc. List \$1.00. Dealers' Price, \$.60

A heavy duty unit for high power variable air condensers or other rotary R.F. units. Insulation—No. 196 Alsimag disc 1 1/2" diameter, 1/4" thick. Special steel cup set screws, heavy N.P. brass hubs, permanently staked into thick nickel plated phosphor bronze springs. Removable bushings to fit 1/4" shafts. Hubs fit 3/8" shafts with bushings removed. List Price \$1.50 Dealers' Price90

voltage are known, proceed as follows: On C find the voltage, on A, the resistance; draw a line connecting these two points over to the B scale. Next, find the voltage (for the second time) on the A scale and draw a line from point B through A. The wattage will be given on C. See the auxiliary figure for an example.

If the current instead of the voltage

is known in the above procedure, the technique is as follows: On C find the value of current; on A, the resistance. A line drawn connecting these points will intercept the wattage rating on V.

Series Capacity Calculations

To determine the value of any two series-capacities, find one of the values on C and the other on B; draw a line to connect these two points; next, add the values of the capacities on B, then from this new point, draw a line to intersect A. The series value will be read on C.

If three series capacities are to be employed, the value of any two of them is found as above, and then this is treated as a single capacity and its value combined with the third by repeating the process, which can be carried on indefinitely.

An example illustrating the method is shown in auxiliary figure (b).

NOTE: Raise the A scale the distance from 1 to 10 when the reading is beyond the bottom, or by taking a piece of tracing paper and tracing the A scale so as to extend it another length of 1 to 10.

Parallel Resistor Calculations

These are treated exactly as series capacities, and the above explanation will apply to all values.

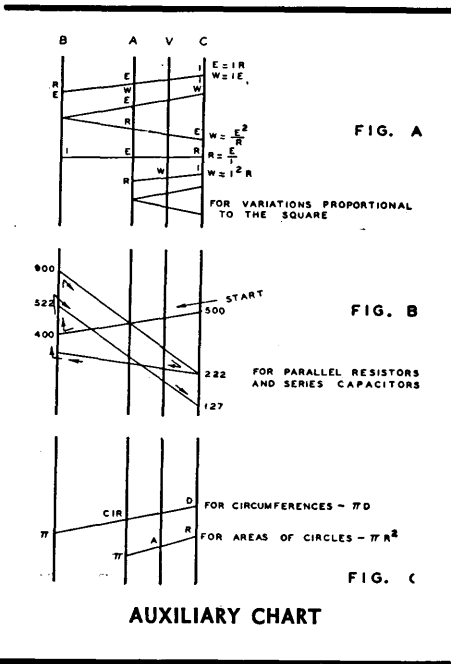

CALCULATION OF INDUCTANCE

The calculation of inductance values for coils in radio transmitter and receiver circuits is not difficult when certain basic considerations are taken into account. There are a number of formulas for such inductance calculations, some laying claim to greater accuracy than others. It must be remembered that most of such formulas give only approximate solutions to practical problems; few claim absolute accuracy. There is lacking an absolutely accurate means of inductance calculations at the frequency at which the inductance is to be used. The following discussion is confined to calculations for single-layer solenoids.

If it is desired to find the value of inductance to tune a receiver circuit to 3,500 kc. with a 50- μ fd. maximum capacity variable condenser the formula is:

$$L = \frac{25,330}{f^2 \times C}$$

For ease of calculation assume that C was to be approximately 41 μ fds., and f was 3.5 megacycles; these values would then give a value of L equal to 50 microhenrys.

AMPEREX

GRAPHITE ANODE TRANSMITTING TUBES

Even cursory inspection will show how AMPEREX tubes differ from the mere adaptations of conventional tube types . . . Exclusive engineering developments and radical design refinements are incorporated in the structure of these tubes and reflected in their superior performance.

So universal has been the recognition of the merits and efficiency of these tubes that now more than 70% of all diathermy ultra short wave generators are equipped with AMPEREX tubes and thousands more are in operation in almost every country in the world . . . in broadcast, communication, amateur and industrial apparatus where they have replaced more costly or less efficient tubes.

Low Distortion zero-bias class B amplifier and modulator, high efficiency R.F. frequency multiplying power amplifier, conventional R.F. power amplifier.

The ZB-120 is an exclusive AMPEREX development. In common with other tubes of original AMPEREX design it is a low voltage high current type and possesses a high ratio of transconductance to interelectrode capacitance. Although it approaches nearer the ideal in a zero-bias class B tube it is also a highly efficient performer in many other classes of service.

GENERAL CHARACTERISTICS

Filament: Voltage	10-10.5 volts
	A.C. or D.C.
Current	2 amperes
Amplification Factor	90
Grid to Plate Transconductance @ 120 ma.	5000 micromhos
Direct Interelectrode Capacitances:	
Grid to Plate	5.2 uuf
Grid to Filament	5.3 uuf
Plate to Filament	3.2 uuf

Net Price **\$10.00**

ZB-120



HF-100



An ultra-high, normal R.F. power amplifier and oscillator and class B audio amplifier or modulator.

The HF-100 is one of a distinctive group of low voltage high current tubes, an original development of the AMPEREX ENGINEERING LABORATORIES. It is in addition characterized by an extraordinary high ratio of transconductance to interelectrode capacitance, a characteristic which is responsible for its outstanding efficiency in ultra-high frequency circuits.

GENERAL CHARACTERISTICS

Filament: Voltage	10-10.5
Current	2 amperes
Amplification Factor	23
Grid to Plate Transconductance @ 100 ma.	4200
Direct Interelectrode Capacitances:	
Grid to Plate	4.5 uuf
Grid to Filament	3.5 uuf
Plate to Filament	1.4 uuf

\$12.50 Net Price

HF-200



High and normal R.F. power amplifier, oscillator, class B modulator.

The HF-200 is another of the highly proficient ultra-high frequency generators of original AMPEREX design and development. The outstanding features of low voltage, high current and a high ratio of transconductance to interelectrode capacitance are also properties of this tube.

GENERAL CHARACTERISTICS

Filament: Voltage	10-11 volts
Current	3.4 amperes
Amplification Factor	18
Grid to Plate Transconductance @ Plate Current of 150 ma.	5000 micromhos
Direct Interelectrode Capacitances:	
Grid to Plate	5.8 uuf
Grid to Filament	5.2 uuf
Plate to Filament	1.2 uuf

Net Price **\$24.50**

HF-300



R.F. power amplifier, oscillator, class B modulator.

The HF-300 has found favor with many broadcasters and transmitter designers as a substitute for the 204A. A study of the operational data will disclose its superiority, in many classes of service, to the latter tube. It also, like the HF-100 and HF-200, is an efficient ultra-high frequency generator and possesses the characteristic common to AMPEREX designed tubes, of a high ratio of transconductance to interelectrode capacitance.

GENERAL CHARACTERISTICS

Filament: Voltage	11-12 volts
Current	4 amperes
Amplification Factor	23
Grid to Plate Transconductance @ 150 ma.	5600 micromhos
Direct Interelectrode Capacitances (App.):	
Grid to Plate	6.5 uuf
Grid to Filament	6.0 uuf
Plate to Filament	1.4 uuf

\$35.00 Net Price

AMPEREX ELECTRONIC PRODUCTS, Inc.

79 WASHINGTON STREET

BROOKLYN, NEW YORK

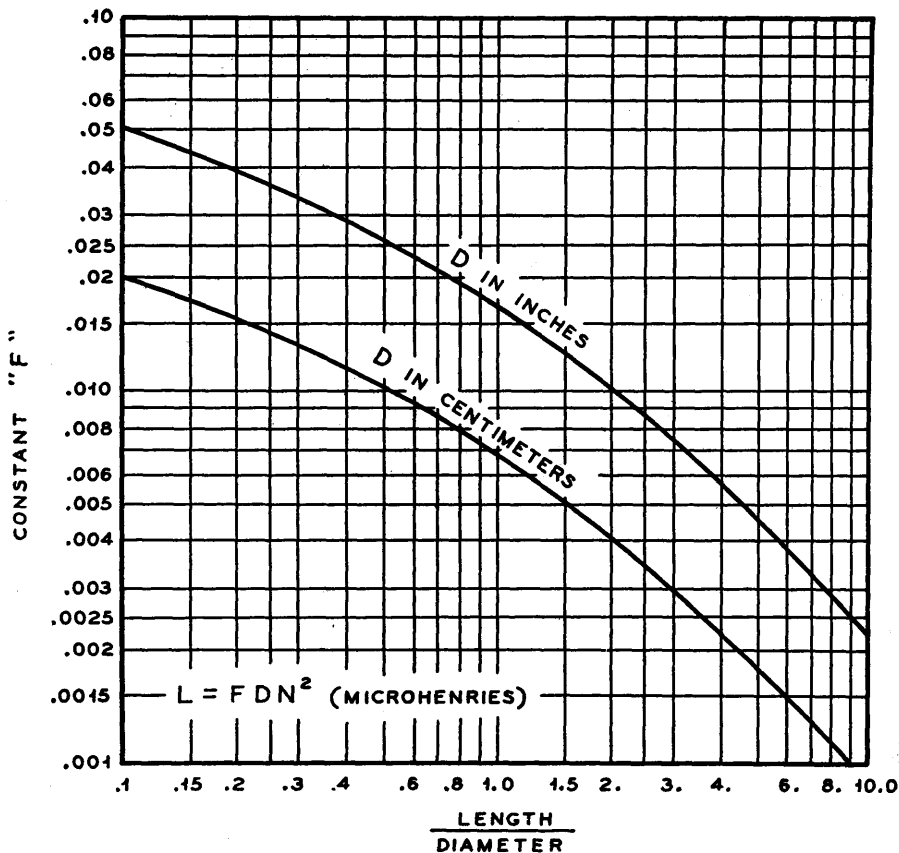

COIL INDUCTANCE CALCULATION CHART

From the formula:

$$N = \sqrt{\frac{L}{df}}$$

where

- N = number of turns,
- L = inductance in microhenrys,
- d = diameter of coil measured to center of wire,
- f = a factor dependent upon the ratio of length of winding to coil diameter.

The value of L is known; the diameter d will be dependent upon the coil form which has been selected. Once the ratio of length to diameter is known, the value of f (constant) can readily be found from the accompanying graph. If the coil diameter is one inch, and if it is

assumed that the winding will be one inch long, the ratio of the two will be unity. From the graph, a ratio of 1 corresponds to factor f of .0175. This graph is published by courtesy of Professor F. E. Terman of Stanford University, in whose textbook, *Radio Engineering*, the original presentation was made.

Continuing with the coil calculations, the values are now substituted in an equation, as follows:

$$N = \sqrt{\frac{50}{1 \times .0175}} = 53.5 \text{ turns.}$$

Referring to the *copper wire table* in the *Power Supply* chapter, it is found that a wire size which will wind approximately 53 turns per inch will be size no. 28 double cotton covered (dcc). This

Complete Transformer Line

DESIGNED TO THE APPLICATION

FOR THE BROADCAST STATION



★ **LINEAR STANDARD** transformers have guaranteed linear response from 30 to 20,000 cycles, ideal shielding and dependability.

TYPICAL ITEMS:

LS-10X, tri-alloy shielded, multiple line to grid,	Net \$12.00
LS-50, low level plate to multiple line,	Net 9.00
LS-55, 2A3's to multiple line and voice coil,	Net 12.00

FOR PORTABLE SERVICE



★ **ULTRA-COMPACT** units weigh only 5 1/4 ounces but have broadcast fidelity, within 2 DB from 30 to 20,000 cycles . . . ideal for remote pickup equipment.

TYPICAL ITEMS:

A-10, universal line to grid,	Net \$6.00
A-24, low level plate to universal line,	Net 6.00
A-16, single plate to single grid,	Net 4.80

FOR THE AMATEUR

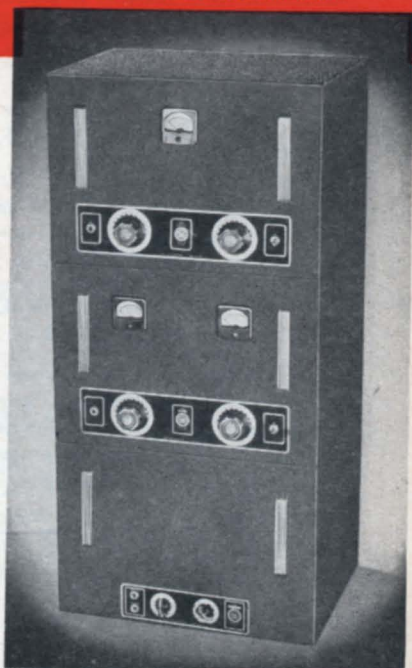

★ **UTC KITS** are available for PA and transmitting applications up to 300 watts. PA units include VARITONE control, volume limiting and many other unique features. The SPECIAL SERIES units represent extreme value, specifically designed to the requirements of the amateur.

FOR COMMERCIAL AND AMATEUR EQUIPMENT

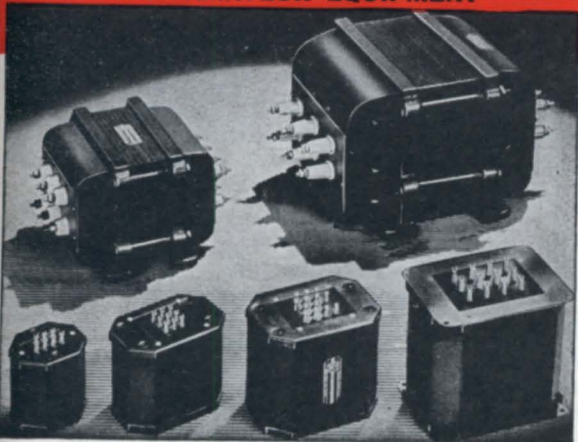

VARIMATCH components include universal driver and output units for every transmitting and PA application.

TYPICAL ITEMS:

VM-4, 300 watts audio to any RF load,	Net \$19.50
PVM-2, 30 watts audio to line and voice coil impedances,	Net 4.80
PA-53AX, P. P. driver tubes to 100/300 watt grids,	Net 4.50

UNITED TRANSFORMER CORP.

72 SPRING STREET

NEW YORK, N. Y.

CALCULATION OF INDUCTANCE (Continued)

wire size will actually wind 54.6 turns per inch, yet it comes closest to what is here desired, and consequently must be used. The actual difference between 53 turns per inch and 54.6 turns is negligible.

The chart will require a bit of practice when used with the foregoing formula; it is suggested that several ratios of length to diameter be experimented

with, insofar as the calculations are concerned, before a coil is actually wound. If the wire size is very small as compared with the diameter of the coil, the stipulation that the diameter be regarded as that measured from the center of the wire can be neglected. If greater accuracy is required, the formula should be converted into centimeters insofar as units of length and diameter are concerned.

RADIO SYMBOLS

The following symbols are commonly used in radio work and many of these symbols are used in the pages of this book:

- E_F Filament (or heater) terminal voltage.
- E_B Average plate voltage (d.c.).
- I_B Average plate current (d.c.).
- E_P A.C. component of plate voltage (effective value).
- I_P A.C. component of plate current (effective value).
- E_G Average grid voltage (d.c.).
- I_G Average grid current (d.c.).
- E_G A.C. component of grid voltage (effective value).
- I_G A.C. component of grid current (effective value).
- E_{FF} Filament (or heater) supply voltage.
- E_{BB} Plate supply voltage (d.c.).
- E_{CC} Grid supply voltage (d.c.).
- MU or μ Amplification factor.
- r_P Plate resistance.
- S_M Grid-plate transconductance (also mutual conductance, gm).
- R_P Plate load resistance.
- Z_P Plate load impedance.
- D.C. Direct Current.
- A.C. Alternating Current.

- RMS Root Mean Square.
- U.P.O. Undistorted power output.
- C_{GK} Grid-cathode (or filament) capacitance.
- C_{PK} Plate-cathode (or filament) capacitance.
- C_{G1P} Effective grid-plate capacitance in a tetrode (cathode [or filament] and screen grounded).
- $C_{G1}(k+\theta_2)$... Direct interelectrode capacitance of grid to cathode (or filament) and screen.
- $C_P(k+\theta_2)$ Direct interelectrode capacitance of plate to cathode (or filament) and screen.
- α , alpha—Coefficients.
- β , beta—Coefficients.
- γ , gamma—Coefficients.
- Δ , delta (capital)—Decrements, increments, variations.
- δ , delta (lower case)—Same as capital delta.
- θ , theta—Angles, phase displacement.
- λ , lambda—Wavelength.
- μ , mu—Amplification factor, prefix micro-.
- π , pi—3.1416, circumference divided by diameter.
- ϕ , phi—Angles.
- τ , tau—Time constant, coefficients.
- ω , omega—Resistance in ohms, 2π times frequency.

FRACTIONAL-DECIMAL EQUIVALENTS

A time-saving table is given for fractional-decimal conversion. Many of the commonly used fractions and their decimal equivalents are shown. Others can be calculated by dividing the numerator by the denominator.

$1/64 = .0165$	$7/16 = .4375$
$1/32 = .0312$	$1/2 = .500$
$3/64 = .0468$	$9/16 = .5625$
$1/16 = .0625$	$5/8 = .625$
$3/32 = .0936$	$11/16 = .6825$
$1/8 = .125$	$3/4 = .750$
$3/16 = .1875$	$13/16 = .8125$
$1/4 = .250$	$7/8 = .875$
$5/16 = .3125$	$15/16 = .9375$
$3/8 = .3750$	

WIRE TABLE
Winding Turns Per Inch

B & S Gauge No.	Winding Turns Per Inch			B & S Gauge No.	Winding Turns Per Inch		
	D.C.C.	S.C.C.	Enamel		D.C.C.	S.C.C.	Enamel
6	5.44	5.60		26	39.90	45.30	57.00
7	6.08	6.23		27	42.60	49.40	64.00
8	6.80	6.94		28	45.50	54.00	71.00
9	7.64	7.68		29	48.00	58.80	81.00
10	8.51	8.55		30	51.10	64.40	88.00
11	9.58	9.60		31	56.80	69.00	104.00
12	10.62	10.80		32	60.20	75.00	120.00
13	11.88	12.06		33	64.30	81.00	130.00
14	13.10	13.45	14.00	34	68.60	87.60	140.00
15	14.68	14.90	16.00	35	73.00	94.20	160.00
16	16.40	17.20	18.00	36	78.50	101.00	190.00
18	20.00	21.00	23.00	38	89.10	115.00	205.00
17	18.10	18.80	21.00	37	84.00	108.00	195.00
19	21.83	23.60	27.00	39	95.00	122.50	215.00
20	23.91	26.40	29.00	40	102.50	130.00	230.00
21	26.20	29.70	32.00	41	112.00	153.00	240.00
22	28.58	32.00	36.00	42	124.00	168.00	253.00
23	31.12	34.30	40.00	43	140.00	192.00	265.00
24	33.60	37.70	45.00	44	153.00	210.00	275.00
25	36.20	41.50	50.00				



Radio Parts

SCIENTIFICALLY CONSTRUCTED



CABINETS

BUD Chassis, relay racks, panels, foundation kits, etc., comprise a complete line of metal radio products. Built for appearance and service, they give a "professional look"—and their sturdy construction will last a lifetime. All sizes and styles, to meet your requirements.

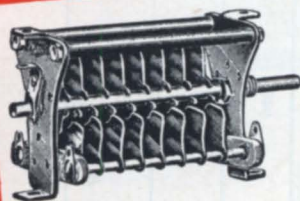

CONDENSERS

For Receivers or Transmitters; Tuning or Neutralizing; Medico Therapy or Industrial use. Whether for one watt or Kilo-watt, there is a Bud precision built condenser to handle the job with complete satisfaction and with greater efficiency.



R. F. CHOKES

BUD Chokes are uniformly built, featuring unusually low power loss and no transmission bands. Made in numerous types and sizes for practically any purpose. They are inexpensive, highly efficient, with a large safety factor.



MISCELLANEOUS

BUD Jacks, Plugs, Sockets, Coil Forms, Switches, Crystal Holders, Dials, Dial Plates, Nameplates, Flexible Couplers, Standoff Insulators, Knobs and many other Bud radio parts will add to the appearance and efficiency of your equipment.

Bud Builds "The Best for Less"

Write for
FREE Catalog J139
or send 10c for big
new Station Log
and Data Book.

BUD RADIO, INC.

CLEVELAND, OHIO

The approved power ratings of vacuum tubes for operation in the last radio stage of broadcast transmitters are fixed by the Federal Communications Commission as set out in the following tables on pages 542, 544, 546 and 548.

POWER RATING OF VACUUM TUBES FOR HIGH-LEVEL MODULATION OR PLATE MODULATION IN THE LAST RADIO STAGE

Power Rating (watts)	Amperex	Collins	DeForest	Eitel McCullough	Federal Telegraph	Heintz & Kaufman	Hygrade Sylvania	RCA Mfg. Co.	United Electronics	Western Electric	Taylor Tubes Inc.
50				50T		HK54		808		211D 211E 248A 276A	T55 841A
75	HF-100 203-A 211 838 852 860	C-203-A C-211	503-A 511 552 560		F-303-A F-311-A F-352-A	154	203-A 211 852 860	203A 211 838 850 860	303-A 311 361-A 938 952	242A 242B 242C 260A 261A 284A 295A	203A 211 211C
100				100TH 100TL	F-102-A F-108-A	254					
125	HF-200 203-H 211-C 211-D 211-H 805	C-200 C-201 C-211-D		150-T	F-123-A			803 805	905		T155 HD-203A
250	204-A HF-300 212-E	C-204-A C-300	504-A 561 571		F-204-A F-212-E F-331-A	354 HK354A HK354C HK354D HK354E HK354F	204-A 212-D 831 861	204A 806 831 861	304-A 312-E	212-D 212-E	T200 204A 814 822
350	270-A 849		549	250TH 250TL 300T	F-100-A F-849		949	849	949	270-A	
500	251-A			450TL 450TH		255 654		833		251A	
750	279-A 849-A 849-H 861	C-849-A C-849-H	551	500T	F-121-A F-351-A	2054-A	851	851	951		
1000	846			750TL 750TH	F-346-A	1554	846	846			

Now Columbus...

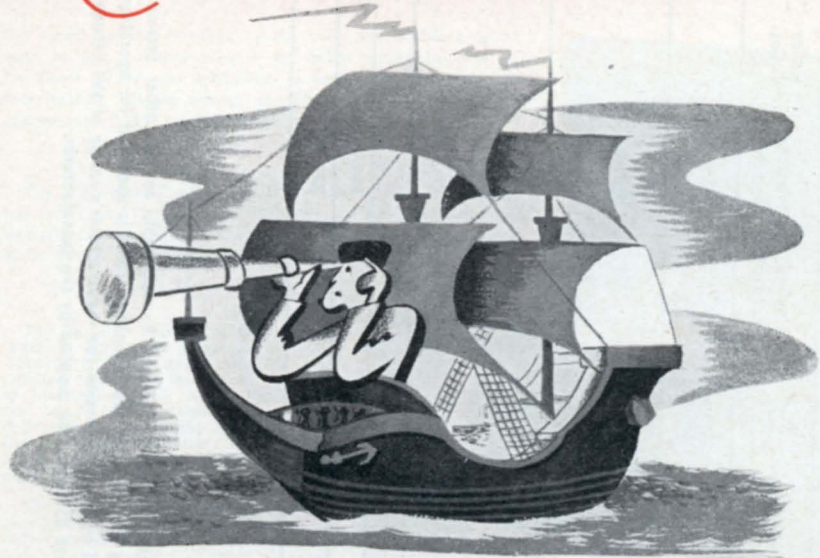

he had to pick his way

**a few of the
entries in our log**

Hammarlund
Hallicrafters
RCA—GE—IRC
National
Lafayette
Bliley
Thordarson
Raytheon
Taylor
UTC
Cardwell
Aerovox
Sangamo
Weston
Sprague
Belden
Birnback
Yaxley
Meissner
Amperex
Western Electric
E. F. Johnson
Hytron and others

A lot of "hams" are in the same boat with Columbus—and don't know it. Chris, you may remember, was searching for a quicker, safer route to the East, where the choicest spices were. And Chris was "flying blind". At that, he had the jump on you hams. For Columbus was in no particular hurry. On top of that he had the wealth of Isabella behind him.

You're no sailor, but you will be interested in this. Wholesale Radio Service Company is the quicker, saving route to everything you need in amateur radio. Hams who come to us are never "flying blind". They know they're going to get good service, fast delivery, rock-bottom prices on the choicest amateur equipment, and whenever they need it—the sound advice of some twenty salesmen-hams.

Next time you're in a hurry, in a jam or simply want to economize for a change, chart your course in our direction. No need to sail due East. We have branches in the Mid-West and South—completely stocked, ready and waiting to serve you. Order from our new 1939 cataLOG No. 73-68.

WHOLESALE RADIO SERVICE CO. INC.
NEW YORK, N. Y. • CHICAGO, ILL. • ATLANTA, GA.
100 SIXTH AVENUE • 901 W. JACKSON BLVD. • 265 PEACHTREE STREET
BOSTON, MASS. • BRONX, N. Y. • NEWARK, N. J. • JAMAICA, L. I.
110 FEDERAL STREET • 342 E. FORDHAM RD. • 219 CENTRAL AVENUE • 90-08 • 166th STREET

Power Rating of Vacuum Tubes for High-Level Modulation or Plate Modulation in the Last Radio Stage (Continued)

Power Rating (watts)	Amperex	Collins	DeForest	Eitel McCullough	Federal Telegraph	Heintz & Kaufman	Hygrade Sylvania	RCA Mfg. Co.	United Electronics	Western Electric	Taylor Tubes Inc.
2500	228A		520-B		F-328-A	3054	820-B	520B		228A	
	1652		520-M		F-328-B			1652			
	207				F-3652-A						
5000	220C		507		F-126-A		207	207		220B	
	848		548		F-307-A	848	848	848		220C	
	863		563		F-320-A	863	863	863		343A	
	891				F-320-B			891			
	892				F-348-A			892			
					F-363-A			892R			
					F-892						
10,000					F-101-B						
					F-110-A						
					F-110-X						
					F-116-A						
					F-332-A				858		232A
					F-332-B						232B
					F-332-C						342A
				F-358-A							
25,000					F-117-B						
					F-124-A						
40,000								862		298-A	
								898			
100,000										320-A	

These tables apply only to tube ratings for use in the last radio stage of broadcast transmitters and may not be applicable to any other service. If, in an application to the Commission, a vacuum tube of a type number and power rating not given in the foregoing tables is specified for operation in the last radio stage, it may be accepted provided there is also submitted to and approved by the Commission the manufacturer's rating of the vacuum tube for the system of modulation or class of service contemplated. These data must be supplied by the manufacturer.

EASY WAY TO LEARN RADIO CODE

To speed up the learning of the code use a Machine to send to you. Always ready—no delay trying to tune in on Short Wave—no schedules to watch for—no weather interference. Beats having another send to you, as you concentrate fully on the study.

STANDARD INSTRUCTOGRAPH

The "Standard," as illustrated, includes the full set of ten tapes and book of instructions. Priced \$20.25, delivered to any point in the United States or Possessions. \$1.00 additional to points in Foreign Countries.

THE "JUNIOR"

The "Junior" Model of the Instructograph, similar in appearance to the "Standard" Machine, only a little smaller, with five tapes and the book of instructions, IS NOT RENTED, but may be purchased for \$12.00, delivered to any point in the United States (slightly higher west of the Rockies, U. S. Possessions and Foreign Countries).

The "Junior" operates just as efficiently as the larger machine, and the difference being mainly in the size, weight and number of tapes supplied. However, additional tapes may be purchased at a reduced rate. Oscillator equipment may be installed in the "Junior" also.

Full Oscillator equipment—Audio transformer, and tube socket wired and installed in the machine, "99" type of radio tube, Key and connecting cord and Trimm head phones. Priced \$6.50.



BOTH MACHINES ARE SOLD ON EASY MONTHLY PAYMENTS IF DESIRED

The "Instructograph" can also be used for American Morse (Wire) Code Instructions, for which tapes are available.

RENTALS [In United States only]

No. 1. Instructograph, tapes and book of instructions: First month \$3.00, each additional month, \$2.25.

No. 2. Instructograph, tapes and book of instructions, with transformer and tube socket wired and installed in machine: First month, \$3.25, and each additional month, \$2.50.

No. 3. Instructograph, tapes, book of instructions, transformer and tube socket installed in the machine, key and connecting cord, and head phones: First month \$3.50, and each additional month, \$2.75.

We pay return transportation charges on all rentals, and pay it both ways if rented for three months or more, and full three months' rental accompanies the order. A deposit of \$10.00, in addition to the rental is required, or satisfactory references asked.

AMATEUR EQUIPMENT

RME, Hallicrafters and the new Howard Receivers, Vibroplex and Speed-X Transmitting Keys (Bugs), Signal Telegraph Instruments for sale, Cash or Terms.

SEND POST CARD FOR DETAILS

THE INSTRUCTOGRAPH CO.

912 LAKESIDE PLACE

(Dept. R-8)

CHICAGO, ILLINOIS

POWER RATING OF VACUUM TUBES FOR LOW-LEVEL MODULATION OR LAST RADIO STAGE OPERATING AS LINEAR POWER AMPLIFIER

Power Rating (watts)	Amperex	Collins	DeForest	Eitel McCullough	Federal Telegraph	Heintz & Kaufman	Hygrade Sylvania	RCA Mfg. Co.	United Electronics	Western Electric	Taylor Tubes Inc.
25						154		203A			203A 211 211C 841A
	HF-200			100TH		354					HD203-A
50	203-H 211-H 242-C			100TL 150-T	F-123-A	HK354A HK354C HK354D HK354E HK354F		803		242B 242C	
75	HF-300 212-E 204-A		504-A		F-204-A F-212-E		204-A 212-D	204A	304-A 312-E	212D 212E	1200 204A 814 822
125	270-A 849		549	250TH 250TL 300-T 450TL 450TH	F-100-A F-849	654	849	849 833	949	270A	
250	251-A 849-A 849-H 851	C-849-A C-849-H	551	500-T	F-121-A F-351-A	255 1554	851	851	951	251A	
350				750TL 750TH							
500	279-A 846				F-346-A	2054-A 3054	846	846		279A	
1000	228-A 1652		520-B 520-M		F-328-A F-328-B F-3652-A		820-B	520B 1652		228A	
2500	207 220-C 863 892		507 569		F-126-A F-307-A F-320-A F-320-B F-363-A F-892		207 863	207 892		220-B 220-C 343-A	
5000					F-358-A			858			
8500	232-B				F-101-B F-110-A F-110-X F-116-A F-332-A F-332-B F-332-C						232-A 232-B 342-A
12,500					F-117-B F-124-A						
25,000								862 898		298-A	
75,000										320-A	

JUST A FEW OF THE MORE THAN 3,000 QUALITY BIRNBACH ITEMS

50 and 10 WATT SOCKETS

Designed especially for U.H.F. work.

No. 434—50 watt socket
List, each \$1.25

No. 435—10 watt socket
List, each \$.85

GIANT INSULATED PLUG

No. 392 with insulated handle. Fits into recess leaving no metal to contact hand. 3" overall. Red or black. List, each... 50c

GIANT INSULATED JACK

No. 393 leaves no exposed metal when mounted on panel. 1 3/8" long, red or black. Complete with nut, insulating washer for 1/2" mtg. hole.
List, each 40c

AIRPLANE INSULATOR

No. 473—2" List Price ea. 7c
No. 474—1 1/2" List pr. ea. 5c

IMPROVED STANDOFF INSULATORS

In a complete range of heights for condensers, coils, etc. White glass.

No.	Heights	List
430	5/8"	10c
431	1"	15c
431J	1"	20c
432	1 1/2"	20c
432J	1 1/2"	25c
433	2 3/4"	50c
433J	2 3/4"	50c

BIRNBACH WIRE DEPARTMENT

The Birnbach wire department is geared to meet your every requirement. Anything and everything in wire and cable: Stranded bare, stranded tinned, stranded enamel, solid bare, solid tinned, solid enamel, stranded colored rubber, colored hook up, test lead wire, leadin, ground, magnet, antenna, hook-up and slip-back wire, mike, battery, S. J. cable.

X'MTR LEAD-IN INSULATORS

Made of highly vitrified glazed porcelain. Feature low absorption.

Cat. No.	List Price
4235 10" rod	\$.90
4236 15" rod	1.00
4237 10" rod with bushings	1.20
4238 15" rod with bushings	1.50
4240 Bushings 1" long, 3/4" Dia.	.05
4241 Bushings 1/2" long, 3/4" Dia.	.05
4242 Bushing 1/4" long, 3/4" Dia.	.05



BIRNBACH ANTENNA INSULATOR

Unusually strong. Long leakage path.

Cat. No.	Length	List Pr. Ea.
470	7"	\$.50
471	12"	.70

FEEDER SPREADERS

Round edges to prevent chafing
462—Feeder line Spreader, 2" long list 12c
464—Feeder line Spreader, 4" long list 15c
469—Feeder line Spreader, 6" long list 20c

EO1 TRANSMISSION CABLE

Can be used any length to 1000 ft. with negligible loss. Handles any power to 1 KW. Surge impedance of 72 ohms.
No. 956—100 ft. spool.

List price \$10.50
250, 500, or 1000 ft. lengths also available.

STRETCHLESS COPPER-WELD ENAMEL ANTENNA WIRE

Steel case, copper covered, heavily enameled, low R.F. resistance. Fine for X'mitting doublet and directional antennae.
No. 12 Gauge — 100 ft.
List price \$1.80

No. 14 Gauge — 100 ft.
List price \$1.25
Special lengths to order.

FEEDTHRU STANDOFF INSULATORS

An original Birnbach development. Two pieces. Designed and proportioned for maximum strength. Brass nickel plated hardware supplied.

Cat. No.	Height	List Price
458	5/8"	\$.12
478	1"	.20
478J.	1"	.25
4125	1 1/4"	.25
4125J.	1 1/4"	.30
4234	2 3/4"	.55
4175J.	2 3/4"	.75

BIRNBACH STANDOFF INSULATORS

Come in fine, properly graduated heights to cover every need. Highly vitrified, low absorption porcelain used throughout.

Cat. No.	Height	List Price
405	5/8"	\$.065
966	1"	.075
966J.	1"	.10
866	1 1/2"	.12
866J.	1 1/2"	.15
866SJ.	1 1/2"	.35

TABLE C
Power Rating of Vacuum Tubes for Grid Bias Modulation in the Last Radio Stage.

Power Rating (watts)	Amperex	Eitel McCullough	Federal Telegraph	Heintz & Kaufman	Western Electric
50	212-E 241-B 270-A	250TH 250TL	F-212-E	354 HK-354 A & C	212-E 270-A
100		300T		654	
125		450TL 500T 750TL		255	
250	849-A 849-H			1554	
500				3054	
1000			F-328-A		228-A
2500			F-307-A		

LIGHT BULB RESISTORS

Ordinary tungsten filament light bulbs make excellent load resistors for radio-frequency and audio tests, since they are noninductive. However, their resistance increases with an increase in power that is applied to them. The table gives the resistance of standard 115-volt bulbs at various wattages. At approximately one-third rated wattage, the filament will show dull red. At two-thirds rated wattage, the filament is bright yellow.

If it is desired to test a 30-watt audio amplifier having a 500-ohm output, two 40-watt bulbs could be used in series. At 30 watts output from the amplifier, the two bulbs will light to a dull red since each one will be dissipating 15 watts, and the load on the amplifier will be 510 ohms.

Light bulb resistors are very useful for terminating untuned feed lines while adjusting coupling to the final amplifier. The bulb will serve as an indicator of maximum r.f. at the same time coupling adjustments are being made.

Various series or parallel arrangements of bulbs will enable the user to secure an infinite number of resistance values. One of the most valuable uses of the light bulb resistor is as a dummy antenna for adjustment of the transmitter.

The resistor may either be clipped across a few turns of the tank coil in the same manner that an untuned transmission line is coupled, or it may be connected across a tuned circuit which is then coupled to the tank. The transmitter can then be completely checked for frequency, percentage of modulation, quality and power output without causing QRM or undergoing the risk of receiving a "pink slip" from the F.C.C.

If the resistance of the dummy antenna is reasonably close to that of the radiation resistance of the antenna, a double-pole, double-throw switch can easily be arranged to shift the output of the transmitter from one to the other. The readings on the r.f. ammeters, with the dummy antenna connected, will give a quick check on the performance of the transmitter.

LIGHT BULB RESISTANCE CHART

Resistance of 115-Volt Tungsten Bulbs

Watts	WATTAGE RATING					
	25	40	50	60	75	100
5	349	195	148	119	90	65
10	412	228	175	139	106	74
15	470	255	194	153	116	81
20	497	273	207	163	124	87
25	529	291	220	172	132	92
30		306	231	181	137	96
35		319	241	189	143	100
40		331	249	197	148	103
45			257	204	153	106
50			265	211	158	110
55				215	162	112
60				220	166	115
65					169	117
70					173	120
75					176	122
80						124
85						126
90						128
95						130
100						132

(Table courtesy "Thordarson Transformer Guide")

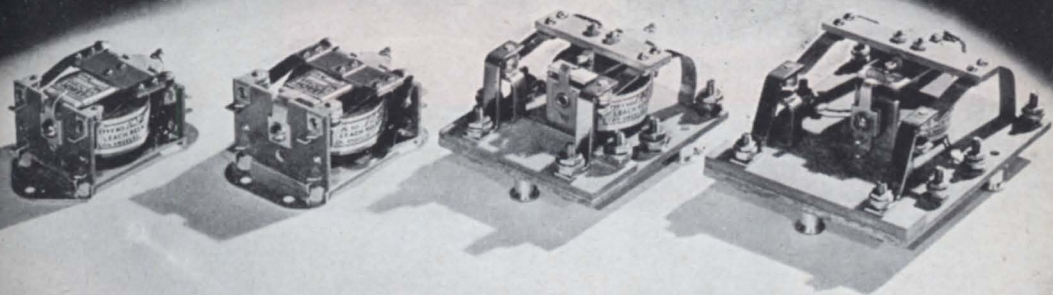

Relays By Leach

- ★ **REMOTE CONTROL**
- ★ **ANTENNA**
- ★ **OVERLOAD**
- ★ **FILAMENT**
- ★ **NEW CIRCUIT CONTROL**
- ★ **KEYING**
- ★ **BREAK IN**
- ★ **POWER**
- ★ **R.F. RELAYS FOR SPECIAL USES**

Among the finer points of Leach Relays: Mycalex insulation; Large contacts; No lag; Flexibility; Instantaneous action; Low current consumption; Ability to work in any position.

Leach engineers have just completed developments on a new light duty circuit control relay which will be of the utmost interest to the amateurs in connection with transmitter work.

Before selecting the relay to fill your need consult us. New literature now available showing latest developments.

Write for yours today.

LEACH RELAY COMPANY

5915 Avalon Blvd.

Los Angeles, Calif.

RADIO

ESTABLISHED 1917

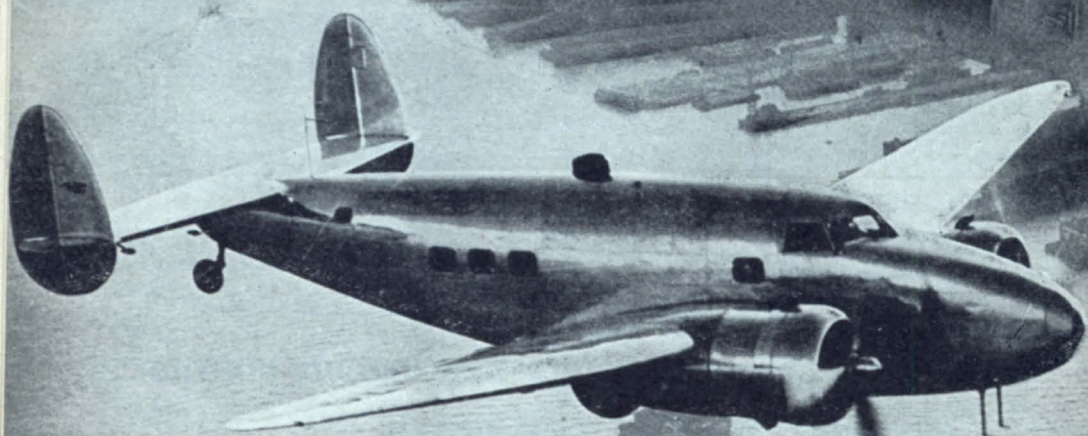

The Worldwide Authority of
Amateur and Shortwave Radio



October 1938

NUMBER 232

30c. IN U.S.A. AND CANADA

1s. 6d. in United Kingdom

2s. in Australasia

W2GOQ, W2UK AND W6CUH
WORK KHBRC
AROUND THE WORLD

The publishers assume no responsibility for statements made herein by contributors and correspondents, nor does publication indicate approval thereof.

In this issue "Radio" presents:

ARTICLES

Frontispiece: W2UK at N. Y. World's Fair Flight Headquarters	10
<i>Photo, Copyright Intl. News Photos, Inc.</i>	
Amateur Radio and the Hughes Flight— <i>R. P. Turner, W1AY/2</i>	11
A. R. R. L. Convention Notes— <i>E. H. Conklin</i>	14
A Direction Indicator for Rotary Antennas— <i>L. C. Waller, W2BRO</i>	16
The Relaxation Oscillator and Streamlined Code Practice Sets— <i>A. W. Friend, W8DSJ</i>	19
Inductive Tuning— <i>Frank S. McCullough, W5BH</i>	23
Dial Phone Remote Control— <i>Geo. M. Grening</i>	
A 100-Watt Bandswitching Exciter— <i>Chas. W6BFC</i>	
Remote Frequency Control— <i>Frank C. Jones</i>	
The Newcomer's Special— <i>Jack Rothman, W6GCT</i>	
A Broadcast-Type Modulation Indicator— <i>W6GCT</i>	
For Amateur Phones—Inverse Feedback— <i>W6JXS</i>	
A Modern U. H. F. Mobile Installation	

Look, O.M.!
 This will give you
 an idea of the
 timely and practical
 material in each
 issue of **RADIO**
 ...73

MISCELLANEOUS FEATURES

From the Private Life of RADIO	5	Advertising Index	
A RADIO Article Is Sent By Teletype	53	The Marketplace	
		Buyer's Guide	98

DEPARTMENTS

DX and Overseas News	54	New Books	66
Calls Heard	58	56 Mc.	59
Postscripts and Announcements	63	What's New on the Market	68
Open Forum	65	Yarn of the Month	72

FRONT COVER—HOWARD HUGHES PLANE (KHBR) FLYING OVER NEW YORK

(Photo, Copyright Intl. News Photos, Inc.)

**THE WORLDWIDE TECHNICAL AUTHORITY OF
 AMATEUR, SHORTWAVE, AND EXPERIMENTAL RADIO**

R-S-T REPORTING SYSTEM

Readability

1. Unreadable.
2. Barely Readable—Occasional words Distinguishable.
3. Readable with Considerable Difficulty.
4. Readable with Practically No Difficulty.
5. Perfectly Readable.

Signal Strength

1. Faint—Signals Barely Perceptible.
2. Very Weak Signals.
3. Weak Signals
4. Fair Signals.
5. Fairly Good Signals.
6. Good Signals.
7. Moderately Strong Signals.
8. Strong Signals.
9. Extremely Strong Signals.

Tone

1. Extremely Rough, Hissing Note.
2. Very rough A.C. Note—No Trace of Musicality.
3. Rough, Low-Pitched A.C. Note—Slightly Musical.
4. Rather Rough A.C. Note—Moderately Musical.
5. Musically Modulated Note.
6. Modulated Note—Slight Trace of whistle.
7. Near D.C. Note—Smooth Ripple.
8. Good D.C. Note—Just Trace of Ripple.
9. Purest D.C. Note.

If the Note Appears to Be Crystal Controlled, Simply Add an X After the Appropriate Number.

ABBREVIATIONS USED BY AMATEURS

Short	Full	Short	Full
ABT	About	CUAGN	See You Again
AGN	Again	DE	From
AHD	Ahead	DA	Day
AHR	Another	DNT	Don't
ANI	Any	DINT	Did Not
APRX	Approximate-Approximately	DH	Deadhead
BC	Broadcast	DC	Direct Current
BD	Bad	DX	Long Distance
B4	Before	ES	And
BI	By	EZ	Easy
BK	Break	FB	Fine Business
BN	Been	FM	From
BT	But	FR	For
BCUZ	Because	FRQ	Frequency
BTWN	Between	GA	Go Ahead
BIZ	Business	GB	Good-Bye
C	See	GM	Good Morning
CLR	Clear	GN	Good Night
CN	Can	GG	Going
CNT	Can't	GT	Got—Get
CK	Check	GND	Ground
CKT	Circuit	HA(HI)	Laughter
CMG	Coming	HM	Him
CUD	Could	HR	Here—Hear
CW	Continuous Wave	HV	Have
CUL	See You Later	HW	How

[Continued on Page 558]



New R. F.



Circuit Hook-Up Wire for Short Wave Transmitters and Receivers

The necessity for correct Hook-Up Wire is just as important as the other component parts used in the construction of the circuits shown in this book. Hook-Up Wire must have proper insulation of high di-electric characteristics for the perfect operation of any transmitter or receiver. LENZ Hook-Up Wire is the best obtainable for short wave work.

It is a wire of extremely low losses at high frequencies. Designed especially for the RF. circuit. Conductors supplied in several sizes, either solid or stranded. Insulation pushes back freely without adhering to the conductor, and is mechanically strong enough to resist abrasion. A fine production wire with insulation impregnated in a high resistant, low-loss, moisture resisting compound.

LENZ wires and cables are carried in stock by leading Dealers and Distributors throughout the country. Use LENZ for better results.



Shielded Cables
 Cotton Braid Overall



Crystal Microphone
 Cable



Tinned Copper
 Shielding



Twisted Pair Braid
 Overall Cable for Doublet
 Antenna System

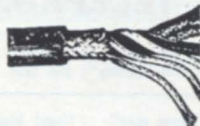

Shielded Rubber
 Jacketed Microphone
 Cable



Shielded Low Capacity
 Weatherproof Tubing
 (Loom)

PARTIAL LIST OF LENZ PRODUCTS:

Push-back wire
 Indoor aerial
 Auto radio cable
 Microphone cable
 Short wave lead-in

Shielded wires and cables
 Speaker and head set cords
 Specially constructed shielded cables
 Battery and speaker extension cable
 Flexible rubber covered lead-in wire

Ground wire
 Shielded low capacity cable
 Elevator annunciator cables
 Organ cables
 Flameproof jumper wire

In Business since 1904

Cable Address: Lenzo Chgo

LENZ ELECTRIC MANUFACTURING CO.
 1753 N. WESTERN AVE. CHICAGO, ILL.

It's the "phone man's 'bible'"

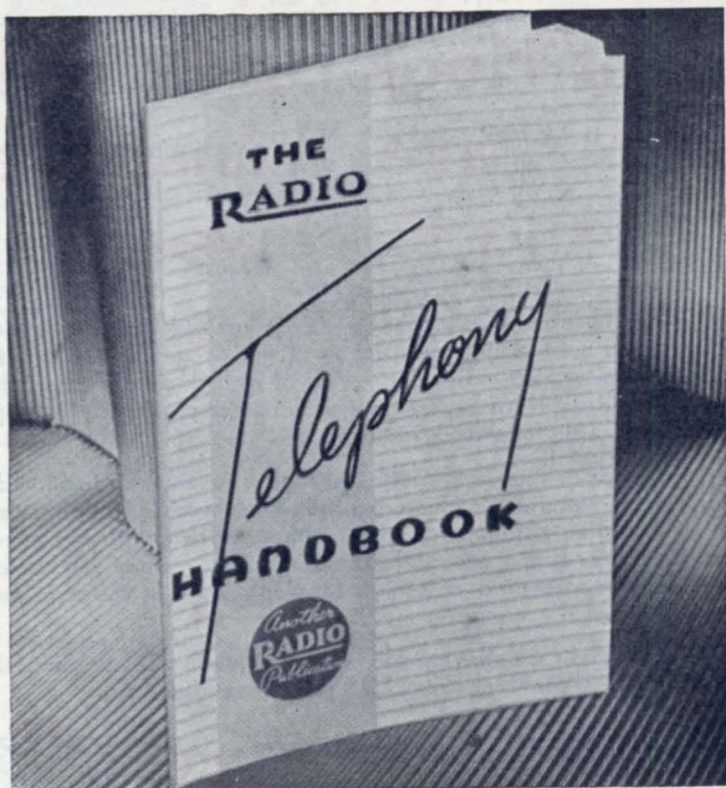

THE "RADIO" TELEPHONY HANDBOOK

Note: copies of the first printing are entitled "Amateur Radiotelephony"; the text is the same.

This book has been written expressly for the "phone man" and the amateur interested in getting on phone. The art of radiotelephony requires more care, more equipment, more knowledge than that of radiotelegraphy.

This clear yet concise work devotes itself particularly to the intricacies and technicalities peculiar to this field, and makes them more understandable to the greater number of experimenters.

A dozen complete transmitters are described from the tiny, ten-watt size up to one kilowatt. Each has been laboratory built and tested, and tested on the air.

It is more comprehensive than the radiotelephony data to be

found in any "general" handbook. It is rapidly becoming the "phone man's bible." None of the transmitters described is found in any other work by "Radio."

All systems of modulation are covered, also class BC amplifiers, inverse-feedback systems, modulation measuring equipment, and the like. Over 100 illustrations show how to construct and adjust all items described.

52 typical questions for the special-privilege Class-A license examination are answered in detail.

The best single investment you can make in your phone transmitter is the purchase of this book at

SEVENTY-FIVE CENTS

in continental U. S. A. Elsewhere, 85c or 3s. 6d.

RADIO
LIMITED

TECHNICAL PUBLISHERS · 7460 BEVERLY BLVD. · LOS ANGELES

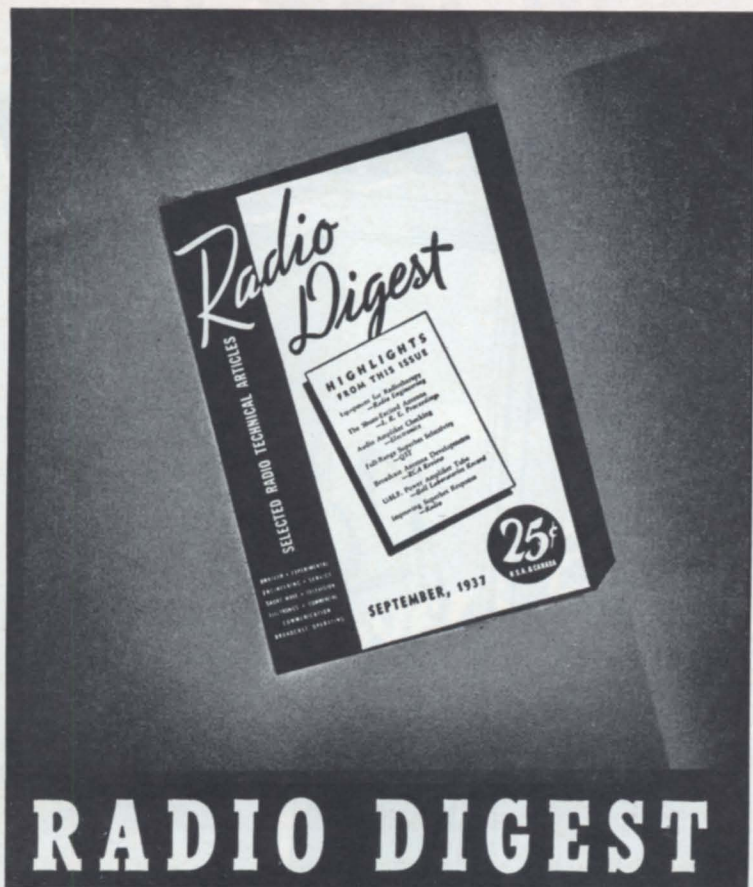

RADIO DIGEST

Because . . .

it is as impossible for even the best technical staff in the world to meet all your needs in one publication, as it is for you to try to read all the books that are written, we give you

RADIO DIGEST, the technical world at a glance . . . Reviews and condensations of the outstanding developments of the month from the leading radio magazines of the world . . . American and foreign.

PRICE, 25c PER COPY

\$2.50 for twelve issues in U.S.A., Canada, and Pan-American countries. Elsewhere, \$3.00 or 12s.6d. (British postal orders accepted) for 12 issues.

RADIO
LIMITED

Technical Publications

7460 Beverly Boulevard, Los Angeles

You'll find it **FASTER** in Saves Time ... Money

- **YOUR BUYING GUIDE**—
The Only Book of its Kind.
Over 600 Pages. Thousands
of different items. All
clearly catalogued. Illustrations—complete specifications—list prices—make buying easy and intelligent to anyone connected with Radio and Allied Industries.
- **YOUR REFERENCE BOOK**—
A wealth of information on
American-made Radio Products immediately available. It might take days, weeks or months hunting for data—but with Radio's Master Encyclopedia, it is at your finger tips.
- **YOUR SALES CATALOG** —
If you sell radio products, Radio's Master Encyclopedia is indispensable. Use it as your own sales catalog. Show it to your customers—solicit orders from it.
- **EASY TO USE** — Every item is indexed and cross-indexed as to classification, manufacturer's names, addresses and page numbers for instant reference. A complete classified directory of 1000 manufacturers in the radio industry. Additional index of trade marks, trade names and registered names with addresses of owners.

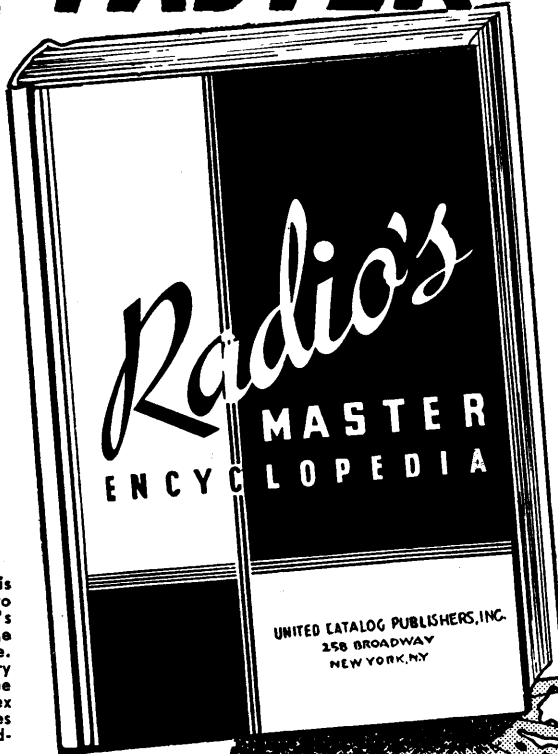

UNIVERSALLY USED

Over 600 Manufacturers' Pages—Full Specifications—Ample Illustrations—List Prices.—Classified Directory of over 1000 Manufacturers of Radio Parts and Equipment — Names — Addresses — Products Made. Index of Trademarks, Registered Names and Their Owners.

If you are in any way connected with Radio or Allied Industries—if you buy—if you sell—if you specify—if you manufacture—you cannot afford to be without this only "OFFICIAL" RADIO MASTER BOOK.

\$3.50

Postpaid
in U.S.A. and
CANADA
Remittance with
order.

UNITED CATALOG PUBLISHERS
258 Broadway
New York, N. Y.



RADIO NEWS

Covers Every
TECHNICAL
Phase of Radio

OVER THE PERIOD OF EACH YEAR, RADIO NEWS COVERS:

Ham Radio; Broadcast Radio; Marine, Government, and Airplane Radio; Commercial & Weather Bureau Radio; also Experimenter's, Constructor's, Servicemen's, Sound Men's & Dxr's Articles; Television Development including receiver and transmitter circuits; Semi-technical and Technical Engineering Information on the Allied Fields to Radio; New Equipment for the Ham, the Serviceman, the Dealer and the Experimenter; Circuits and Constructional Articles on Transmitters, Receivers, Testers, Antennae, P.A. Systems, Call Systems, Amplifiers, and Gadgets; Amateur Radio Politics; etc., etc.; in fact each and every phase of technical radio throughout the entire radio field and its allied branches. IF IT'S RADIO (Technical) IT'S IN RADIO NEWS.

RADIO NEWS

608 S. Dearborn Street—Chicago

ENCLOSED is \$.....

Please send RADIO NEWS to

Name

Address

City

State

6 Months, \$1.00

1 year, \$2.50

2 years, \$4.00

Start with

Issue



ABBREVIATIONS USED BY AMATEURS

(Continued from page 552)

Short	Full	Short	Full
IC	I See	OB	Old Boy
ICW	Interrupted Continuous Wave	OL	Old Lady
K	Go Ahead	OM	Old Man
LID	Poor Operator	OP	Operator
LIL	Little	OT	Old Top—Timer
LFT	Left	OW	Old Woman
LST	Last—Listen	PLS	Please
LTR	Letter	PSE	Please
MA	Milliampere	PX	Press
MC	Megacycle	R	OK
MG	Motor Generator	RCD	Received
MI	My	RCVR	Receiver
MK	Make	RI	Radio Inspector
MO	More	SA	Say
MSG	Message	SEZ	Says
MT	Empty	SM	Some
ND	Nothing Doing	SW	Short-Wave
NG	No Good	SIG	Signal
NIL	Nothing	SKED	Schedule
NM	No More	TFC	Traffic
NR	Number	TMW	Tomorrow
NW	Now	TR	There
		TT	That

KITS by "RADIO-TEL"

- **BI-PUSH EXCITER**
- **BI-PUSH POWER SUPPLY**
- **RT-10A, RT-25A, RT-50A**
Sp. Amp.—Modulators
- **"10-20" FINAL AMP.**
- **"FLEXTAL" CONV. EXCITER**
- **MODULATORS**
- **"THE MIGHTY MITE"**
- **DYNAPUSH EXCITER**

"Radio-Tel" has ten active amateurs on its staff, each one being a specialist.

"Radio-Tel" will be glad to quote you on almost any unit described in this Handbook.

"Radio-Tel" has designed kits on the famous Bi-Push Exciter, "10-20" Final, Dynapush Exciter, and the Flexital Conversion Exciter, all of which have been taken from the original articles in "RADIO."

Every kit brought out by "Radio-Tel" during the past two years is enjoying success, together with its increasing popularity among the hams throughout the world.

"Radio-Tel" has the largest stock of amateur radio parts in the entire west, and is a real rendezvous for hams.

Write us for information on any of the above units.

W6CUH—W6QD—W6LFC—W6FMK—W6JWQ—W6NOF—W6CCX—W6NYU—W6DUX—W6EAS

RADIO-TELEVISION SUPPLY COMPANY

"WHERE HAM SPIRIT PREVAILS"

1701 So. Grand Ave.

Los Angeles, Calif.

TK	Take
TKS	Thanks
TNK	Think
TNX	Thanks
U	You
UD	You Would
UL	You Will
UR	Your
VB	Very bad
VT	Vacuum Tube
VY	Very
WA	Word After
WB	Word Before
WD	Would
WF	Word Following
WK	Work
WL	Will—Would
WN	When
WT	What
WX	Weather
X	Interference
XMTR	Transmitter
YF	Wife
YL	Young Lady
YR	Your
30	Finish—End
73	Best Regards
88	Love and Kisses

● When you do a bang-up job you want the panel instruments to measure right up to the rest of the outfit. At the same time you don't want to spend a fortune.

Right here is where Simpson comes in. It's no longer necessary to pay a premium for panel instruments with the finer bridge type construction and soft iron pole-pieces. The new Simpson Instruments give you these and other quality features at prices no higher than you have paid for the ordinary run of instruments. They are actually the only instruments in the world incorporating these features at low prices.

Better PANEL
INSTRUMENTS
AT PRICES YOU
CAN AFFORD!

Write for Catalog No. 10

SIMPSON ELECTRIC CO., 5220 Kinzie St., Chicago



A typical Simpson value is illustrated here—a bridge-type instrument in a beautiful, modern 3"x3½" case with illuminated dial and built-in 6-V lamp at a net price to amateurs in most A.C. and D.C. ranges of only... **\$4.65**

Another big Simpson value is this 3" bridge type Milliammeter at only... **\$4.15**

SIMPSON Instruments that
STAY accurate

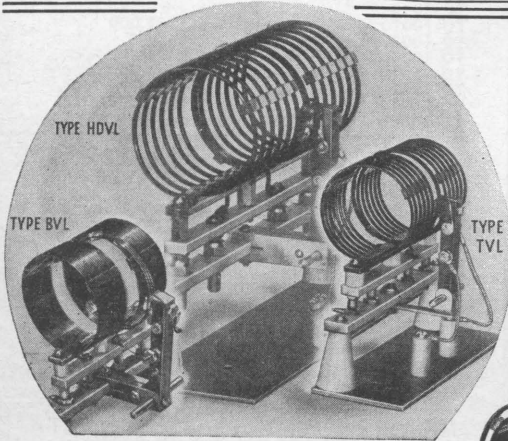

**SWINGING LINK
ASSEMBLIES**

Three sizes—for high, medium and low power. Economical, positive, accurate... the ultimate in efficient control of loading and excitation in final stages. Unexcelled to maintain positive balance by individually metering tube grids and plates in push-pull circuits. Designed to allow front-of-panel coupling control.

See the B & W line at your jobbers—
or write for details

B & W AIR INDUCTORS
... for *EVERY* Application!

The B & W line includes 13 different types—65 coils—3 Variable Link Assemblies and the sensational Model B Band Switching Turret! Anything you need from 10 to 160 meters—from 25 Watts to 1 Kilowatt!

AIR INDUCTORS are made by coil specialists... "Lock-Strip" wound on precision machines to assure uniform air-spacing and ample mechanical strength. This perfectly air-spaced winding eliminates the mass losses experienced in even the best ceramic forms. Use B & W's for any inductance application—note their higher efficiency... low dielectric loss... rugged construction... scientific design... their all-round dependability even under extreme conditions!

MODEL B TURRET

Another B & W masterpiece! Good to look at, a revelation to use—the B & W TURRET gives you smoother, easier, faster three-band switching than ever before. Accepted by "hams" and commercial operators as the most efficient band switching method on the market today!

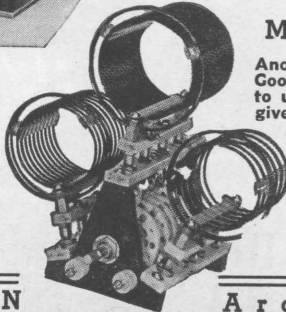

BARKER & WILLIAMSON

Ardmore, Pa.

CORNELL DUBILIER

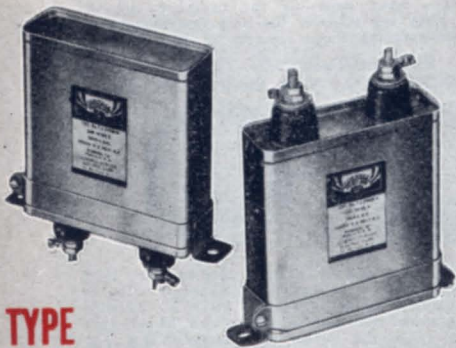

**TYPE
TJ-U**



**TYPE
QT**



**TYPE
TL-A**

DYKANOL TRANSMITTING CAPACITORS TYPE TJ-U

A notable record of performance of these hermetically sealed, fire-proof Dykanol capacitors is attested by the fact that they rarely fail in service when operated even at 10% higher voltage than rating. For complete technical data and listing see Catalog No. 161.

Cat. No.	Cap. Mfd.	Working Voltage	List Price
TJU-6020	2	600 V.D.C.	\$3.50
TJU-6040	4	" "	4.50
TJU-10020	2	1,000 "	4.00
TJU-10040	4	" "	5.00
TJU-15020	2	1,500 "	5.00
TJU-15040	4	" "	7.00
TJU-20020	2	2,000 "	5.50
TJU-20040	4	" "	9.00
TJU-30020	2	3,000 "	15.00
TJU-30040	4	" "	22.00

CYLINDRICAL CASE DYKANOL CAPACITORS TYPE TQ

Type TQ are genuine DYKANOL, fireproof transmitting filter capacitors that can be mounted vertically or inverted by mounting ring supplied. Equipped with neat porcelain terminals. Real values—never before offered to the trade.

Cat. No.	Cap. Mfd.	Working Voltage	List Price
TQ-6020	2	600 V.D.C.	\$2.25
TQ-6040	4	" "	3.00
TQ-10010	1	1,000 "	2.25
TQ-10020	2	" "	2.75
TQ-10040	4	" "	3.75
TQ-15010	1	1,500 "	3.00
TQ-15020	2	" "	3.75
TQ-20010	1	2,000 "	3.75
TQ-20020	2	" "	4.25

DYKANOL FILTER CAPACITORS TYPE TLA

These fire-proof units are encased in cylindrical aluminum containers, are not only classical in appearance but also in performance. They solve the need for a compact high voltage filter capacitor to use with high fidelity P. A. amplifiers, power supplies for short wave portable transmitters and transceivers. Type TLA will withstand transient voltages as well as high peak voltage surges and is designed to operate for continuous, full load duty.

Cat. No.	Cap. Mfd.	Working Voltage	List Price
TLA-6020	2	600 V.D.C.	\$2.25
TLA-6040	4	" "	3.00
TLA-10020	2	1000 V.D.C.	2.75

MICA RECEIVING - TRANSMITTING CAPACITORS TYPE 4 and TYPE 9

The evolution of the original small "micadon" capacitor has resulted in the perfection of Types 4 and 9 mica units. Effectively used for r.f. bypass, high voltage D.C. blocking, low power tank capacitors, padders, coupling functions, audio and video purposes. Type 4 uses short solder-lug terminals and has insulated mounting holes for panel mounting.

TYPE 4 LISTING

Cat. No.	Capacity Mfd.	Test Voltage	List Price
4-6Q5	.00005	1,000 V.D.C.	\$.35
4-6T1	.0001	" "	.35
4-6D1	.001	" "	.40
4-6D2	.002	" "	.45
4-6D6	.006	" "	.65
4-6S1	.01	" "	.80
4-6S2	.02	" "	1.20

TYPE 4 LISTING (Continued)

Cat. No	Capacity Mfd.	Test Voltage	List Price
4-12Q5	.00005	2,500 V.D.C.	.60
4-12D1	.001	"	.75
4-12D2	.002	"	.95
4-12D5	.005	"	1.50
4-12S1	.01	"	2.35
4-25Q5	.00005	5,000 V.D.C.	.70
4-25T25	.00025	"	.90
4-25T5	.0005	"	1.25
4-25D1	.001	"	1.20
4-25D2	.002	"	2.25
4-25D5	.005	"	3.50

TYPE 9 LISTING

The terminal studs in type 9 are mounded into case.

Cat. No.	Capacity Mfd.	Test Voltage	List Price
9-6Q5	.00005	1,000 V.D.C.	\$.40
9-6T25	.00025	"	.40
9-6D1	.001	"	.50
9-6D2	.002	"	.50
9-6D5	.005	"	.70
9-6D6	.006	"	.85
9-6S1	.01	"	1.15
9-6S5	.05	"	3.85
9-12Q5	.00005	2,500 V.D.C.	.70
9-12T1	.0001	"	.70
9-12T25	.00025	"	.70
9-12T5	.0005	"	.70
9-12D1	.001	"	.90
9-12D2	.002	"	1.35
9-12S1	.01	"	2.80
9-25Q5	.00005	5,000 V.D.C.	.90
9-25T25	.00025	"	1.05
9-25D1	.001	"	1.50
9-25D2	.002	"	2.25
9-25D5	.005	"	3.40
9-25S1	.01	"	4.10

MICA TRANSMITTING CAPACITORS

TYPE 86

By selecting the very best grade of India ruby mica, the Type 86 capacitors have a very low r.f. resistance and power-factor, but extremely high D.C. resistance and negligible power losses. The patented design has eliminated corona and reduces internal heating, so that the Q quality characteristics, important on hi-frequencies, is exceptionally high.

Cat. No.	Capacity Mfd.	Max. D.C. Voltage	Max. Current in Amps.					List Price
			30mc	1500kc	7500kc	3750kc	1875kc	
31A-86	.0001	12,500	5	5	4	3	2	\$3.57
325A-86	.00025	12,500	5	7	8	6	4	3.75
35A-86	.0005	12,500	5	8	9	8	7	4.25
35C-86	.0005	7,000	5	7	8	6	4	3.75
21A-86	.001	12,500	5	9	10	11	12	5.00
21C-86	.001	7,000	5	8	9	10	8	4.25
215A-86	.0015	12,500	6	9	10	11	12	5.50
22A-86	.002	12,500	6	9	12	13	15	6.50
22C-86	.002	7,000	6	8	9	10	10	5.25
25B-86	.005	10,000	7	10	13	14	15	9.50
11C-86	.01	7,000	7	10	13	15	15	9.50

The above listed units are but a few of the more popular types. For complete listings, send for Catalog No. 161. The complete C-D line of quality capacitors are available at all C-D authorized distributors. Remember—C-D capacitors are copied, imitated—but never duplicated. For real quality insist on C-D capacitors—the pioneer condenser for more than a quarter of a century.

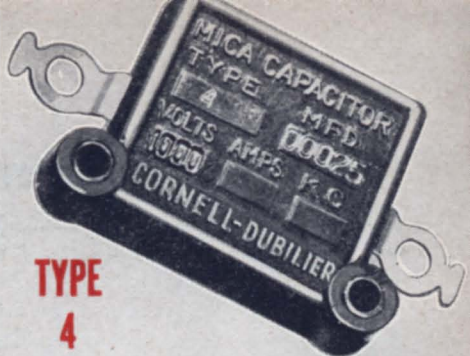

TYPE 4



TYPE 9



TYPE 86

X-MITTING CAPACITORS

INTERNATIONAL PREFIXES

AC4Tibet	EIEire (formerly Irish Free State)
ARSyria	ELLiberia
CEChile	EQIran (ex-Persia)
CMCuba	ESEstonia
CN1Tangier	FFrance
CN8Morocco (French)	FAAlgeria
COCuba (Phones)	FBMadagascar
CPBolivia	FCClipperton Is.
CR4Cape Verde	FDTogoland (French)
CR5Portuguese Guinea	FECameroons (French)
CR6Angola	FFFrench West Africa
CR7Mozambique	FGGuadeloupe
CR8Portuguese India	FIFrench Indo-China
CR9Macao	FKNew Caledonia
CR10Timor	FLFrench Somali Coast
CT1Portugal	FMMartinique
CT2Azores	FNFrench India
CT3Madeira	FOFrench Oceania, Tahiti
CXUruguay	FPSt. Pierre & Miquelon
DGermany	FQFrench Equatorial Africa
EA1-5, 7Spain	FRReunion
EA6Balearic Islands	FTTunis
EA8Canary Islands	FUNew Hebrides
EA9Spanish Morocco (No. Africa)		

Diathermy

HEADQUARTERS

Radio Supply has in stock at all times complete diathermy equipment, including pads, special applicators, tubes and all necessary equipment. Diathermy kits ready to assemble or wired and tested.

Write for data

Radio Supply Company

950 South Broadway

Los Angeles, Calif.

Electrical Efficiency— Physical Ruggedness

DISTINGUISH DECKER STEELCORE COILS

No mere claims or statements could account for the increasing popularity of Decker Steelcore (copperweld) Coils throughout the entire Radio World. These coils because of their better, more modern construction are telling their own story with increased efficiency and longer life which means a dollars and cents saving to you.

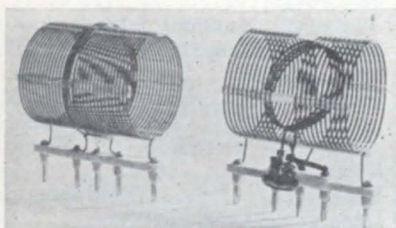

Decker Coils are infinitely stronger, being wound with Steelcore (copperweld) wire—which also gives you a better Q than identical solid copper wire coils. All Decker Coils have Steatite mounts and jack bars throughout. No joints or unions intervene between the winding and the base plugs—the wire from the coil itself is brought down to form the stand-off; this construction enables us to maintain a good form factor in all bands.

There are two Decker Coils for each series in the 160, 80 and 40 meter bands. One gives proper L/C ratio for best operation and the other is designed to use a low capacity condenser for lower frequencies.

Decker Variable (rotating) link coils—Series MR and BR—are similar to M's and B's except for the link construction. They fit interchangeably in the same jack-bars with their semi-variable counterparts. Removing the coil from the rig does not disturb the setting of the link and as the latter is inside

the main coil no more space is needed than for a fixed link coil.

Series M and MR will handle 500 watts—Series B and BR “Smile at a kilowatt.”

Order Decker Coils from this list. Semi-Variable Links.

Catalog and Band No.	Resonating Capacity	List Price	Catalog and Band No.	Resonating Capacity	List Price
M10C3	10	3.75	B10C3	12	7.00
M20C3	12	4.25	B20C3	12	7.75
M40MC3	30	4.75	B40MC3	30	8.35
M40LC3	15	4.75	B40LC3	15	8.35
M80MC3	70	5.50	B80MC3	50	9.00
M80LC3	25	5.50	B80LC3	25	9.00
M160MC3	75	6.25	B160MC3	120	10.25
M160LC3	45	6.25	B160LC3	50	10.25

Rotating Links

MR10	25	8.25	BR10	25	13.25
MR20	30	8.75	BR20	30	14.00
MR40	40	9.25	BR40	35	14.60
MR80	70	9.90	BR80	70	15.25
MR160	120	10.75	BR160	120	16.50
M1 Steatite Jack bar for			M-MR Coils		1.75
B1 Steatite Jack bar for			B-BR Coils		2.75

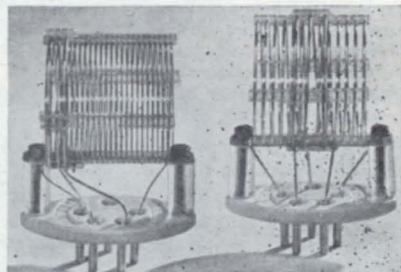

DECKER SERIES L PLUG-IN COIL

These 50 watt coils are mounted on ceramic bases and in the 5, 10 and 20 meter bands are wound with heavy, silver plated wire. Links are silverplated, are semi-variable and can be changed to one, two or three turns. These coils can be ordered with or without center taps, with end or center links, or unlinked. All L coils can be resonated with 50 mmfd. condenser except 160 meter which requires 100 mmfd. All L series coils \$1.65 list.

Decker Mfg. Co.

SOUTH PASADENA, CALIF.

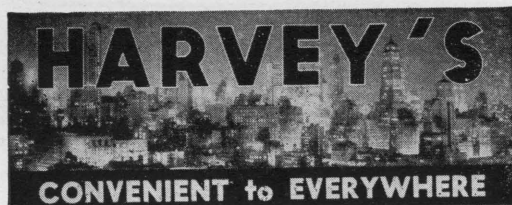

DID YOU KNOW . . .

☆ that HARVEY'S will custom build any kit, described in this or any other publication. . . We've been keeping our eyes peeled for really good constructional articles . . . and as soon as we see one that should appeal to the amateurs, we assemble it in kit form . . . ready for wiring . . . So write in and tell us what you want; we may even have it "ready-to-ship" . . .

☆ that HARVEY'S is open till 8:00 P.M. for your shopping convenience . . . if you're anywhere near New York . . . you're convenient to HARVEY'S . . . because HARVEY'S is only one block from Times Square . . . in the heart of New York . . .

☆ that HARVEY'S carries a complete stock of products of practically EVERY reputable radio parts manufacturer . . . including broadcast and communication receivers . . . electric appliances . . . etc. . .

☆ that HARVEY'S maintains a complete CAMERA department, movies and stills, for the "photo-minded" amateur . . . If you are a "radio-photo" man . . . by gum, we can sell you CAMERAS . . . We've got 'em . . . plenty of 'em . . . all kinds of 'em . . . accessories, too . . .

☆ that HARVEY'S will arrange liberal "trade-in" deals on camera for radio . . . or if you prefer, radio for camera . . .

☆ that HARVEY'S will go to extremes to satisfy a customer . . . whether over the counter or through the mails . . . so if you can't "make it" personally . . . WRITE.

REMEMBER

☆ that . . . whether the commodity being purchased is merchandise or a service . . . a transmitter, a camera or a haircut . . . the wise and experienced buyer looks closely at the reputation of the company who sells it . . .

☆ that HARVEY'S has earned the confidence and goodwill of amateurs everywhere . . . through an earnest endeavor to give them a BIGGER value for their "ham" dollar.

OUR BEST VALUE IS OUR LONG RECORD OF LOYAL SERVICE

HARVEY

Radio Company of New York
 103 WEST 43 STREET NEW YORK, N. Y.
 CABLE ADDRESS "HARADIO"

INTERNATIONAL PREFIXES

(Continued)

FY	French Guiana
G	England and the Channel Islands
GI	Northern Ireland
GM	Scotland
GW	Wales
HA	Hungary
HB	Switzerland
HC	Ecuador
HH	Haiti
HI	Dominican Republic (See also VP2)
HJ, HK	Colombian Republic
HP	Panama
HR	Honduras
HS	Siam
HZ	Saudi Arabia
I	Italy
I7	Italian East Africa (Ethiopia)
J	Japan
J8	Korea
J9	Marshall Islands & Formosa
K4	Puerto Rico, Virgin Islands
K5	Canal Zone
K6	Guam, Hawaii, Midway Island, Samoa (U. S.) Wake Island
K7	Alaska
KA	Philippine Islands
LA	Norway
LU	Argentina
LX	Luxembourg
LY	Lithuania
LZ	Bulgaria
MX	Manchukuo (Manchuria)
N.	U. S. Naval Communication Reserve Stations
NY	Canal Zone
OA	Peru
OE	Austria
OH	Finland
OK	Czechoslovakia
OM	Guam
ON	Belgium
OQ	Belgian Congo
OX	Greenland
OY	Faroe Islands
OZ	Denmark
PA	Netherlands
PI	Netherlands (Schools)
PJ	Curacao
PK	Neth. East Indies
PX	Andorra
PY	Brazil
PZ	Surinam (Dutch Guiana)
SM	Sweden
SP	Poland
ST	Sudan
SU	Egypt
SV	Greece

SV6	Crete
TA	Turkey
TF	Iceland
TG	Guatemala
TI	Costa Rica
U, UE, UK, UX	U.S.S.R.
VE	Canada
VK	Australia
VO	Newfoundland (Labrador)
VP1	British Honduras
VP2	Dominica, Grenada, St. Lucia, Antigua, St. Kitts-Nevis
VP3	British Guiana
VP4	Trinidad & Tobago
VP5	Cayman Islands, Jamaica, Turks & Caicos Islands
VP6	Barbados
VP7	Bahamas
VP8	Falkland Islands South Georgia
VP9	Bermuda
VQ1	Zanzibar
VQ2	Northern Rhodesia
VQ3	Tanganyika
VQ4	Kenya
VQ5	Uganda
VQ6	British Somaliland
VQ8	Mauritius
VQ9	Seychelles
VR1	Gilbert & Ellice Islands
VR2	Fiji Islands
VR3	Fanning Island
VR4	Br. Solomon Islands
VR5	Tonga Islands
VR6	Pitcairn Island
VS1	Straits Settlements
VS2	Federated Malay States
VS3	Non-Federated Malay States
VS4	Sarawak and N. Borneo
VS5	Labuan, Brunei
VS6	Hong Kong
VS7	Ceylon
VS8	Bahrein Island
VS9	Maldive Islands
VU	British India
VU4	Laccadive
W	United States
XE	Mexico
XU	China
XZ	Burma
YA	Afghanistan
YI	Iraq (formerly Mesopotamia)
YJ (**FU8)	New Hebrides
YL	Latvia
YM	Danzig
YN	Nicaragua
YR	Roumania

Par-Metal

A NEW MODERN LINE OF RACKS, PANELS, & CHASSIS FOR EVERY PURPOSE.

A line of chassis . . . racks and panels in gray or black wrinkle. Streamlined, smart looking, they blend well with red, black or chrome.

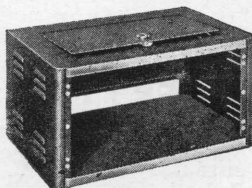
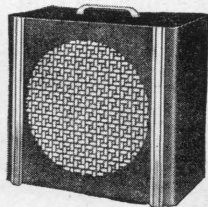
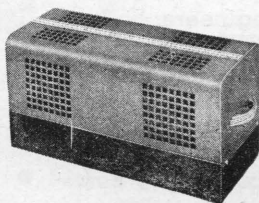

**Free Catalog
Now Ready**

Just off the press. Illustrates and describes the complete PAR-METAL line. You need one if you're planning to build.

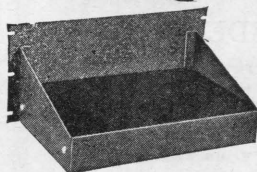
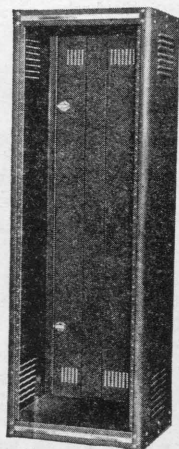
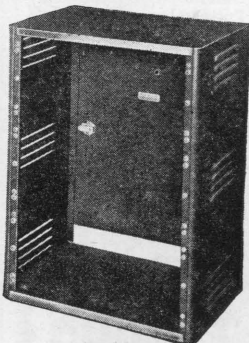

WRITE TODAY
for your copy of catalog No. 39.

**PAR-METAL PRODUCTS
Corp.**

3521 41st Street, Long Island City, N. Y.

* Suggested by the British Empire Radio Union.
** Official, by French Govt.

AT YOUR SERVICE

EVERY DAY IN THE YEAR

For 16 years we have taken pride in the **SERVICE** which we have rendered to **Amateurs, Experimenters, Technicians and Engineers**. Folks tell us that **SUN** gives the **fastest service and the most dependable service**. They say that if it's a "hard to get" part you want to be sure to see **SUN** because *they can deliver!*

ALL NATIONALLY KNOWN LINES!!

Aerovox
 Aladdin
 Amperex
 Amperite
 Amphenol
 Astatic
 Barker-Williamson
 Birnbach
 Brush
 Bud
 Cardwell
 Centralab
 Cornell-Dubilier
 Coto
 Dumont
 Eby
 Eimac
 Gammatron
 Hallcrafters
 Hammarlund
 Hytron
 I.R.C.
 Johnson
 Littelfuse

Miller
 Meissner
 McElroy
 National
 Ohmite
 Parmetal
 Raytheon
 R.C.A.
 R.M.E.
 Shure
 Signal
 Speed-X
 Stancor
 Sylvania
 Temeo
 Taylor
 Thordarson
 Triplett
 U.T.C.
 Ward
 Leonard
 Weston
 Wright-Decoster
 Yaxley
and many others

FAST MAIL ORDER SERVICE

You don't have to live in or near New York to be able to take advantage of **SUN SERVICE** . . . We have customers all over the world who swear by us . . . not at us! Try us and see for yourself.



RADIO CO.
 212 Fulton Street, New York, N. Y.
EST. 1913 SUNBADIO NEW YORK

YS	Salvador
YT, YU	Jugoslavia
YV	Venezuela
ZA	Albania
ZB1	Malta
ZB2	Gibraltar
ZC1	Transjordania
ZC2	Cocos Islands
ZC3	Christmas Island
ZC4	Cyprus
ZC5	Palestine
ZD1	Sierra Leone
ZD2	Nigeria, Cameroons (British)
ZD3	Gambia
ZD4	Gold Coast, Togoland (British)
ZD6	Nyasaland
ZD7	Saint Helena
ZD8	Ascension
ZD9	Tristan da Cunha
ZE1	Southern Rhodesia
ZK1	Cook Islands
ZK2	Niue
ZL	New Zealand
ZM	Western Samoa
ZP	Paraguay
ZS, ZT, ZU	Union of So. Africa, South Africa
ZS3	South-West Africa

PREFIXES BY COUNTRIES

Afghanistan (A)	YA
Alaska (NA)	K7
Albania (E)	ZA
Algeria (AF)	FA
Andorra (E)	PX
Angola (AF)	CR6
Antigua (NA)	VP2
Argentina (SA)	LU
Ascension (AF)	ZD8
Australia (O)	VK
Austria (E)	OE
Azores (AF)	CT2
Bahamas (NA)	VP7
Bahrein Island (A)	VS8
Balearic Islands	EA6
Barbados (NA)	VP6
Belgian Congo (AF)	OQ
Belgium (E)	ON
Bermuda (NA)	VP9
Bolivia (SA)	CP
Borneo (O)	VS4
Brazil (SA)	PY
British Guiana (SA)	VP3
British Honduras (NA)	VP1
Br. Solomon Islands (O)	VR4
British Somaliland (AF)	VQ6
Bulgaria (E)	LZ
Burma (A)	XZ

Cameroons (British) (AF)	ZD2
Cameroons (French) (AF)	FE
Canada (NA)	VE
Canal Zone (NA)	K5, NY
Canary Islands (AF)	EA8
Cape Verde (AF)	CR4
Cayman Islands (N)	VP5
Ceylon (A)	VS7
Chile (SA)	CE
China (A)	XU
Christmas Island (O)	ZC3
Clipperton Islands	FC
Cocos Islands (O)	ZC2
Colombian Republic (SA)	HJ, HK
Cook Islands (O)	ZK1
Costa Rica (NA)	TI
Crete	SV6
Cuba (NA)	CM, CO
Curacao (SA)	PJ
Cyprus (E)	ZC4
Czechoslovakia (E)	OK
Danzig (E)	YM
Denmark (E)	OZ
Dominica (NA)	VP2
Dominican Republic (NA)	HI
Dutch East Indies (see Neth. Indies)	
Ecuador (SA)	HC
Egypt (AF)	SU
Eire (E)	EI
Ellice Islands (See Gilbert)	WR1
Estonia (E)	ES
Falkland Islands (SA)	VP8
Fanning Island (Q)	VQ1 (VR3*)
Faroe Islands (E)	OY
Fiji Islands (O)	VR2
Finland (E)	OH

* Suggested by the British Empire Radio Union.

RELAYS

by Guardian

NEW
R-100
RF

These GUARDIAN Relays are built and engineered for radio transmission in the amateur field where size, current drain, ease of wiring and mounting are of utmost importance.

★
KEYING RELAYS
Model K-100,
net \$3.30

★
BREAK-IN
RELAYS
Model B-100,
net \$4.50

★
OVERLOAD
RELAYS
Model L-250,
(250 ma.) net \$4.50
Model L-500,
(500 ma.) net \$4.50
Model X-100, ad-
justable Overload
Relay (150 to 500
ma.) Net \$7.20

★
TIME DELAY
RELAYS
Model T-100,
net \$9.00

FOR BAND SWITCHING
AND HIGH VOLTAGE
KEYING

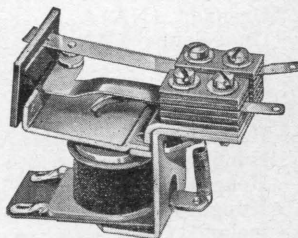

R-100 is used in sound transmitter tuning circuits to 1 KW and 14 megacycles, on all circuits to .5 KW, for shorting coil turns, adding condensers, switching crystals, etc. May also be used in conjunction with high voltage keying rigs.

R-100 contacts are single pole, single throw, normally open. Coil wound for 110 volts. Very low capacity between contacts, and contacts and ground. Self insulated. Easily mounted on panel, requiring but two holes. Solder lug type terminals, tinned phosphor bronze contact springs, insulated by Triple-X bakelite. List \$2.50.

R-100-C identical with R-100, but has single pole, double throw contacts. List \$3.00.

American Microphone Co., Inc.

INTEREST Increases in
DYNAMICS

A Most POPULAR Pickup
High or Low Impedance
RUGGED HIGH OUTPUT

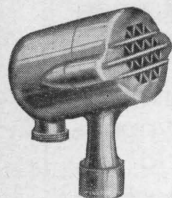

D7T LIST \$22.50
D7 LIST \$20.00

IMMUNE TO TEMPERATURE
CHANGES, EXCELLENT FRE-
QUENCY RESPONSE

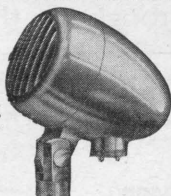

New B9 Crystal

Microphone D5T Dynamic List \$32.50
D5 Dynamic List \$27.50

A Good Microphone, Small and Efficient With
Plug at Microphone (An "American" Feature)
Permitting Quick Cable Replacement

Licensed under Patents Brush
Development Co.

Catalogue #27 Shows New
Accessories



B9 List
\$22.50

1915 South Western, Los Angeles, Cal.

RELAYS by GUARDIAN

perform perfectly in the

CIRCUIT DIAGRAMS

shown in this book

WRITE TODAY

for FREE BULLETINS

and CIRCUIT DIAGRAMS

Address Dept. H

GUARDIAN  **ELECTRIC**

100 W. WALNUT STREET

CHICAGO, ILLINOIS

France (E)	F	Jugoslavia (E)	YT, YU
French Equatorial Africa	FQ	Kenya (AF)	VQ4
French Guiana (SA)	FY	Korea	J8
French India (A)	FN	Latvia (E)	YL
French Indo-China (A)	FI	Liberia (AF)	EL
French Somali Coast	FL	Lithuania (E)	LY
French West Africa	FF	Luxembourg (E)	LX
Gambia (AF)	ZD3	Macao (A)	CR9
Germany (E)	D	Madagascar (AF)	FB
Gibraltar (E)	ZB2	Madeira (AF)	CT3
Gilbert & Ellice Islands (O)	VR1	Malaya (A) ... Federated States, VS2; Non-Federated States, VS3	
Great Britain (E)	G, GI, GM, GW	Maldive Islands (A)	VS9
Greece (E)	SV	Malta (E)	ZB1
Greenland (NA)	OX	Manchukuo (A)	MX
Grenada (NA)	VP2	Martinique (NA)	FM
Guadeloupe (NA)	FG	Mauritius (AF)	VQ8
Guam (O)	K6, OM	Mexico (NA)	XE
Guatemala (NA)	TG	Midway Island (O)	K6
Haiti (NA)	HH	Morocco, French (AF)	CN8
Hawaii (O)	K6	Morocco, Spanish	EA9
Honduras (NA)	HR	Mozambique (AF)	CR7
Hong Kong (A)	VS6	Netherlands (E)	PA, PI
Hungary (E)	HA	Netherlands East Indies (O)	PK
Iceland (E)	TF	New Caledonia (O)	FK
India, British (A)	VU	Newfoundland (NA)	VO
Iran (ex-Persia) (A)	EQ	New Hebrides (O)	YJ (**FU8)
Iraq (A)	YI	New Zealand (O)	ZL
Italy (E)	I		
Jamaica (NA)	VP5		
Japan (A)	J		

** Official, by French Govt.

LEEDS' *New Address*

75 Vesey Street

- A new building for an old established firm, built upon honest and fair business dealings for over 16 years.
- At our new address we will be in a position to continue giving you the same service which has become synonymous with the name *Leeds* throughout the world.

Metropolitan Distributors for Kenyon and General Radio

● **We Also Carry**

National	Weston	Johnson	Ward Leonard
Hammarlund	Triplet	Cardwell	

and other leading lines. All parts listed in the
RADIO HANDBOOK carried in stock.

BROWNING LABORATORIES INC. PRESENTS

THE EXCITER TWINS! BL 5G & 5P

AN
ODD
PLACE

to say
it, but
you know,
OM, reading
the RADIO DI-
GEST gives you
a good feeling.
You know you're
wise to the impor-
tant things happen-
ing in radio all over
the world. Some of the
publications used in giv-
ing you the dope are RADIO,
QST, RADIO ENGINEERING, COM-
MUNICATIONS, SERVICE, ELECTRON-
ICS, SUCCESSFUL SERVICING, RADIO
NEWS, BELL SYSTEM TECHNICAL JOUR-
NAL, RCA REVIEW, IRE PROCEEDINGS,
BELL LABS RECORD, RADIO ENGINEER,
BROADCAST NEWS, RADIO REVIEW, T. & R.
BULLETIN, plus all the leading foreign
journals, trade and house organs.

The most important articles are condensed
or reprinted, and others are reviewed in "thumb
nail" sketches. Diagrams, photographs, tables
are all included, and it's really interesting...
good to have when you can't spare the time or money
reading a lot of magazines. Why not try six issues
for \$1.50? It's bimonthly, so that's a year's supply.
It's published by the editors of RADIO, which is an-
other good sign that it's worth reading. The address:
7460 BEVERLY BLVD., LOS ANGELES, CALIF.

WRITE FOR DETAILS

GIVE YOUR
JOBBER'S NAME

BRING US TOGETHER AND WATCH US WORK

BROWNING LABORATORIES INC. WINCHESTER, MASS.



I'M G!

5 HIGH Q GRID CIRCUIT
COILS WITH TANK CONDENSER-
RIGIDLY MOUNTED ON BAND-
SWITCHING ARRANGEMENT.
TUNES ONE BAND BELOW THE
10-20-40-80 AND 160 METER
BANDS TO ALLOW HARMONIC
OPERATION IN THE PLATE CIRCUIT.
NEW DESIGN SILVER CAP BAND-SETTING
CONDENSERS ELIMINATE FREQUENCY
DRIFT AND MAKE CALIBRATION
PERMANENTLY RELIABLE.

BUILD AN IDEAL BAND-SWITCHING
EXCITER. HIGH C GRID CIRCUIT AND
HIGH L PLATE CIRCUIT MAKE FOR
MAXIMUM STABILITY AND OUTPUT.
THESE TWO TUNERS SOLVE YOUR
EXCITER PROBLEMS ONCE AND
FOR ALL. 5 BANDS 10-20-40-80-
AND 160 METERS. HARMONIC OPERA-
TION ON 5 METERS. GRID COILS
ONE BAND BELOW PLATE COILS AL-
LOWING HARMONIC OPERATION IN
PLATE CIRCUIT FOR BED-ROCK
STABILITY.

35 WATTS OUT!

USE THE BL-5G AND BL-5P IN
YOUR FAVORITE EXCITER CIRCUIT.
35 WATTS OUTPUT. DOUBLE TO
5 IN THE OUTPUT STAGE AT 20
WATTS. NOTE FROM ELECTRON
OSCILLATOR CANNOT BE TOLD
FROM CRYSTAL.

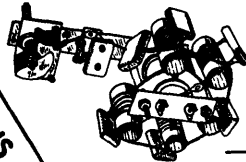

-HAVE YOU SEEN THE BL 5H?-

THE MOST VERSATILE TUNER EVER OFFERED
TO THE AMATEUR FRATERNITY.
DESIGNED PRIMARILY FOR A SIMPLE EFFICIENT
RECEIVER, THIS LITTLE TUNER IS THE
BASIS OF ANY APPARATUS WHERE AN
EFFICIENT TUNED CIRCUIT COVERING
THE AMATEUR BANDS IS REQUIRED
BUILD A PRESELECTOR, A WAVE-
METER, A HAM-BAND SIGNAL
GENERATOR. COVERS HAM BANDS
FROM 10 UP, AND SELLS AT AN
AMAZINGLY LOW PRICE

I'M P!

THE IDEAL PLATE CIRCUIT
TUNER. 5 HIGH Q COILS WITH
BAND-SWITCHING ARRANGE-
MENT AND TANK CONDENSER.
TUNES THE 10-20-40-80-
AND 160 METER BANDS
HIGH L/C RATIO PROVIDES
MAXIMUM OUTPUT

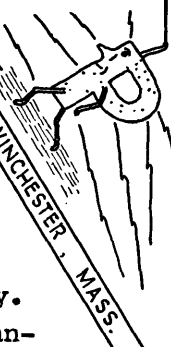

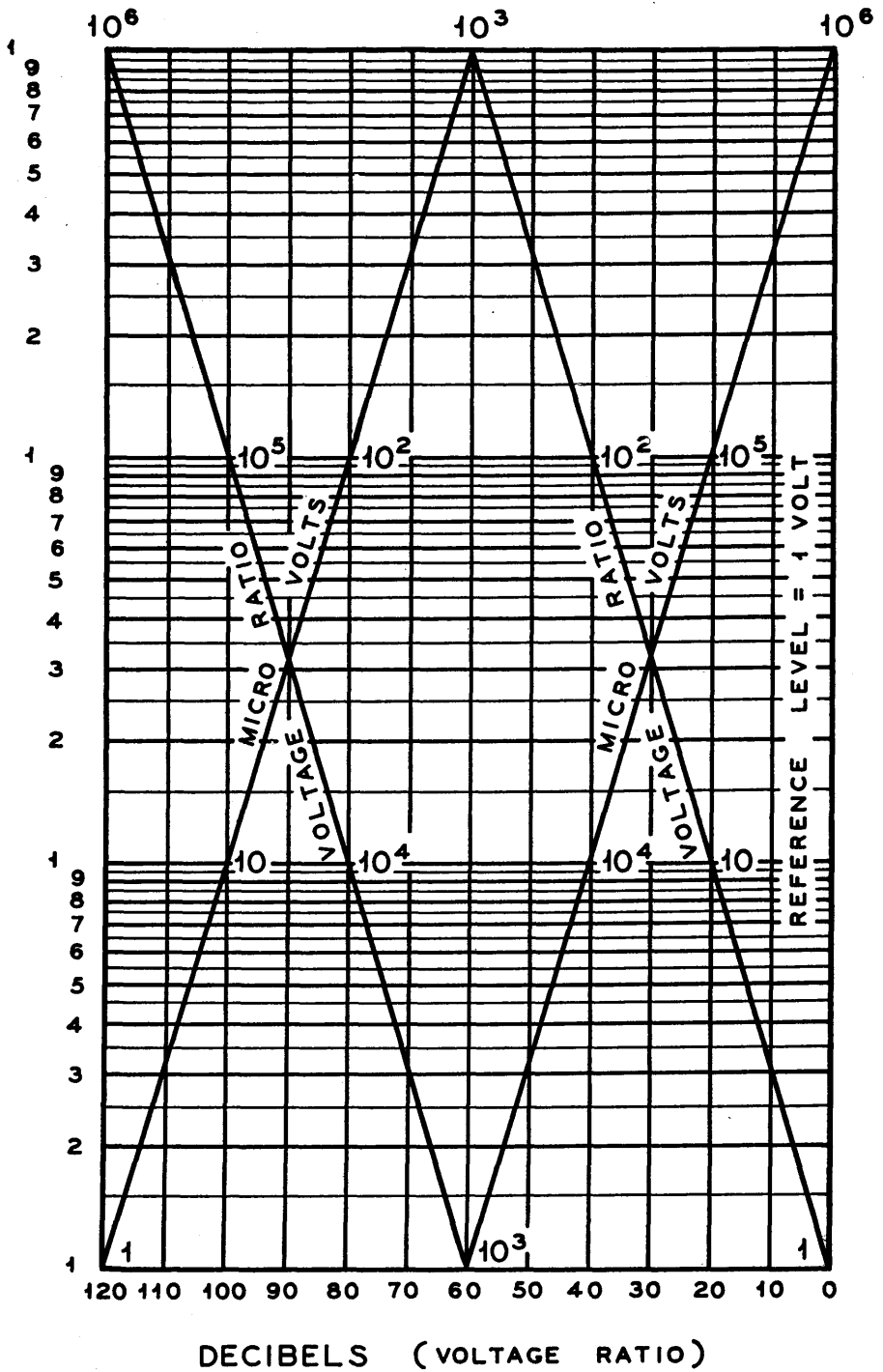

NEW!

120-PAGE COMPLETE INSTRUCTION BOOK

Detailed wiring instructions! Diagrams! Schematics! Pictorial Diagrams! Alignment Data! And operating instructions for all Meissner units!

A NEW Book!—Page after page of invaluable information, both theory and technical data. With graphs and charts; contains pictorial diagrams, schematic diagrams, alignment data, constructional data and operating instructions for 20 of the new Meissner receiver kits; also adapters and converters.



AT YOUR PARTS JOBBERS

NET PRICE 50c
OR ORDER DIRECT FROM THE FACTORY
ADDRESS DEPT. RH-8

Meissner

MT. CARMEL, ILLINOIS

"A FAMOUS NAME FOR TWO DECADES"

NOW



Now you can get **WESTON METERS** for that new rig at prices below what you pay for an inferior instrument! Slightly used metal cased Model 301, 3" panel instruments. Fully guaranteed.

D. C. MILLIAMMETERS

NUMBER	SCALE	YOUR COST
HB-100	0-1 M. A.	\$4.95
HB-101	0-1.5 M. A.	4.95
HB-102	0-5 M. A.	2.95
HB-104	0-15 M. A.	2.95
HB-105	0-25 M. A.	2.95
HB-106	0-50 M. A.	2.95
HB-107	0-100 M. A.	2.95
HB-108	0-150 M. A.	2.95
HB-109	0-200 M. A.	2.95
HB-110	0-250 M. A.	2.95
HB-111	0-300 M. A.	2.95
HB-112	0-500 M. A.	2.95

D. C. AMMETERS

HB-113	0-1.5 Amp.	2.95
HB-114	0-5 Amp.	2.95

D. C. VOLTMETERS

HB-120	0-5 Volts	2.95
HB-122	0-15 Volts	2.95
HB-123	0-50 Volts	2.95
HB-124	0-100 Volts	3.50

A. C. VOLTMETERS

HB-140	0-1.5 Volts	2.95
HB-141	0-3 Volts	2.95
HB-142	0-5 Volts	2.95
HB-143	0-100 Volts	3.95
HB-145	0-150 Volts	3.95

A. C. RECTIFIER TYPE VOLTMETER

HB-160	0-3 Volts	5.95
--------	-----------	------

MODEL 425 THERMO-GALVANOMETER

HB-170	0-115 M. A.	3.95
--------	-------------	------

Everything For The Ham.

Send for a copy of our 1939 Catalog

HERBACH & RADEMAN INC.

"Radio In All Its Branches"

522 Market Street
 Philadelphia, Pa.

PREFIXES BY COUNTRIES

(Continued from page 568)

Nicaragua (NA)	YN
Nigeria (AF)	ZD2
Niue (O)	ZK2
Northern Ireland (E)	GI
Northern Rhodesia (AF)	VQ2
Norway (E)	LA
Nyasaland (AF)	ZD6
Ocean Island (See Gilbert)	VR1
Palestine (A)	ZC5
Panama (NA)	HP
Paraguay (SA)	ZP
Persia (See Iran)	EQ
Peru (SA)	OA
Philippines (O)	KA
Pitcairn Island (O)	VR6
Poland (E)	SP
Portugal (E)	CT1
Puerto Rico (NA)	K4
Portuguese Guinea	CR5
Portuguese India	CR8
Reunion (AF)	FR
Roumania (E)	YR
Saint Helena (A)	ZD7
St. Kitts-Nevis (NA)	VP2
St. Lucia	VP2
St. Pierre & Miquelon (NA)	FP
Salvador (NA)	YS
Samoa (O)	K6, ZM
Sarawak (O)	VS5
Saudi Arabia (A)	HZ
Scotland (E)	GM
Seychelles (AF)	VQ9
Siam (A)	HS
Siberia (see U.S.S.R.)	U, UE, UK, UX
Sierra Leone (AF)	ZD1
French Somali Coast	FL8
South Georgia (SA)	VP8
Southern Rhodesia (AF)	ZE1
Spain (E)	EA1-5,7
Straits Settlements	VS1
Sudan (AF)	ST
Surinam (Dutch Guiana) (SA)	PZ
Sweden (E)	SM
Switzerland (E)	HB
Syria (A)	AR
Tahiti (O)	FO
Tangier	CN1
Tanganyika (AF)	VQ3
Tibet (A)	AC4
Timor	CR10
Togoland (British) (AF)	ZD4
Togoland (French) (AF)	FD
Tonga Islands (O)	VR5
Transjordan (A)	ZC1
Trinidad & Tobago (SA)	VP4
Tristan da Cunha (AF)	*ZU9
Tunis (AF)	FT
Turkey (E&A)	TA

* Suggested by the British Empire Radio Union.

Uganda (AF)	VQ5
Union of South Africa	ZS, ZT, ZU
United States (NA)	W
U. S. Naval Communication Reserve Stations (NA)	N
Uruguay (SA)	CX
U.S.S.R. (E&A)	U, UE, UK, UX
Venezuela (SA)	YV
Virgin Islands (NA)	K4
Wales (E)	GW
Western Samoa (O) (British	ZM
Zanzibar (AF)	VQ1

THE EXPERIMENTAL LICENSE

Where Required and How Obtained

Any licensed amateur who chooses to conduct experiments at his station, whether he plans honest-to-goodness scientific investigation or only wishes to test a new rig, is within his right as long as the experiments are non-commercial in character and he confines his transmissions to amateur frequencies. The amateur station license, however, does not authorize any type of experimenting where money-making features are involved, whether stated or implied; the use of frequencies other than those allocated for amateur communication; or the use of types of emission not permitted to amateur stations.

For all special experimental work, the Federal Communications Commission issues an experimental class station license, and this ticket must be obtained whenever anticipated experiments cannot be covered by the accepted definition of ama-

teur radio communication. The experimental license is not a ham ticket, though the call letters are made up with the district numeral in the conventional amateur fashion. The one distinguishing feature of the call is the initial letter, X (such as W1XYZ).

Special frequencies are set aside for use by X-stations, and the particular ones chosen by an applicant should best suit the conditions under which he plans to operate. An applicant for an experimental license is required to request one or more of these definite frequencies, as the Commission neither assigns frequencies individually nor advises applicants which would be the best ones for their particular experiments. Whatever the frequencies chosen, the applicant must satisfy the Commission that his equipment will enable him to maintain those frequencies within three-hundredths of one per cent, plus or minus. And he must show that he has precision monitoring equipment indicate this small tolerance.

The experimental service includes (1) general experimental stations, (2) special experimental stations, (3) experimental broadcast stations, and (4) experimental visual broadcast (television)





E. H. RIETZKE **PRES. OF CREI**

A JOB . . . or a FUTURE

—which for You?



New 48-Page BOOKLET FREE

"A Tested Plan for a Future in Practical Radio Engineering". Illustrates and describes courses. Write for your FREE copy.

There's always a better job for a better man

We want men who want futures. Radio wants and needs men with technical ability and is willing to pay . . . if they have the modern training necessary for advancement. Prepare yourself for big opportunities by applying yourself to CREI training. It has helped others and can help you—let us tell you how.

Practical Radio Engineering

For experienced men, available in 3 courses: Home Study . . . Residence . . . and Combination of Home Study and Residence.

Service and Public Address

Advanced Service course for professional radiomen. (If interested in Service, please state in inquiry.)

Capitol Radio Engineering Institute

Dept. RO-9
 3224—16th St., N.W., Washington, D. C.



The AMPERITE

ACOUSTIC COMPENSATOR

gives you

HIGH OR LOW PITCH

WITH THE SAME MICROPHONE

With the flip of a finger you can now (1) lower or raise the response of the microphone. . . (2) adjust the microphone for most desirable response for close talking or distant pickup. . . (3) adjust the system to any "taste", room condition, or equipment.

MODELS RBHk, RBMk, with Acoustic Compensator, frequency range 40 to 11000 cps, output, -65 db., complete with switch, cable connector and 25' of cable. \$42.00 LIST

NEW! MODEL RSHk (hi-imp): RBSk (200 ohms) Frequency range 60 to 8000 C.P.S. Output -68db. . . Chrome or Gun-metal \$32.00 LIST

NEW LOW PRICE CONTACT "MIKE"

Model SKH (hi-imp); SKL (200 ohms) \$12.00 LIST

MODELS RAH-RAL, excellent for speech and music. Reduce feedback. \$22.00 LIST

Write for Complete Illustrated Bulletins and Valuable Sales Helps.

AMPERITE 661 BROADWAY, N. Y.
Cable Address: Alkern, New York

AMPERITE *Velocity* **MICROPHONE**

stations. It is assumed that the average amateur of experimental bent will be interested only in the first two classifications, hence this discussion will be confined to general and special stations.

Rules 303 and 304 (Rules and Regulations of the Federal Communications Commission) define these two classes of experimentals as follows: "The term 'general experimental station' means a station equipped to carry on research or development in the radio art requiring the transmission of radio-frequency power and operating on frequencies designated by the Commission for general experimental service. The term 'special experimental station' means a station used to carry on special research or development in the radio art which because of the nature of the experiments, requires frequencies other than those designated for general experimental stations."

The following frequencies are allocated for general experimental service: 1614, 2398, 3492.5, 4797.5, 6425, 8655, 12862.5, 17310, 23100, 25700, 26000, 27100, 31600, 35600, 38600, 41000, 36000 to 400,000 and 401,000 kilocycles and above. An applicant may request any or all of these frequencies, but he must be equipped to maintain the 0.03% tolerance on each one requested.

None of the frequencies is assigned exclusively to any one applicant; they are shared by similar stations throughout the country, and when interference results, the license holders are required to arrange a division of time.

Special Experimental Frequencies

Special X-stations may ask for definite frequencies other than those in the above list when the proposed owners can show that the general experimental frequencies are unsuitable for their research. Where the frequency requested is already

in use by some other radio service, the applicant must make arrangements with those services beforehand in order that interference may be prevented and in many cases must file with his application statements from the other services that experimental use of the frequency is agreeable.

Special Operators License Necessary

Experimental stations may be operated only by individuals who hold commercial operator licenses of the radiotelegraph third class or higher, except in the case of stations employing frequencies higher than 30,000 kc. where an amateur operator license is acceptable.

Emissions Permitted

A1 (c.w. telegraphy), A2 (i.c.w. telegraphy), A3 (radiotelephony), and "special" types of emission are authorized under the experimental license, and the applicant may request permission to use any or all. Under the heading of special are included all types of keying, modulation, etc., which cannot be classified as A1, A2, or A3.

Experimental applicants may ask for definite operating hours or may request unlimited time.

Application Procedure

The prospective experimental's first job will be to apply to the Commission for a construction permit. The application, Form 401, is an eight-page document containing thirty-four questions. Herein, the applicant requests the frequency desired, hours of operation, operating output power, and emission. He must state the proposed location of the station to the nearest degree, minute, and second, north latitude and west longitude, and must list the airways and airports within ten

Radio Supply Company

Largest Radio Parts Distributor in the West

ALL MAJOR LINES "IN STOCK"

AN EFFICIENT MAIL-ORDER SERVICE

A COMPETENT STAFF OF ACTIVE AMATEURS
TO SERVE YOU

Try Us

RADIO SUPPLY COMPANY

950 South Broadway

Los Angeles

miles of the location. He must also state the number of persons residing within one mile and within five miles of the proposed transmitter.

The type of experimental research to be carried on must be described in detail, and the applicant's own technical qualifications, or the qualifications of those he will engage to carry on the work, must be outlined. A *bona fide* statement must be made of the applicant's financial responsibility to see the work through.

Most difficult of all, the applicant must satisfy the Commission that his proposed researches will be in the public interest, convenience, and necessity. A large number of applicants are refused the construction permit because they fall down on this last requirement.

Before filling out an application for station construction permit, a study should be made of Rules and Regulations of the Federal Communications Commission, with particular attention to the section on Experimental Services. The booklet may be obtained for thirty-five cents from the Superintendent of Documents, Government Printing Office, Washington, D. C.

The construction permit bears the call-letters of

the station, frequency (s), power output of transmitter, emission (s), and hours of operation, and authorizes the building and testing of the equipment described in detail in the application. Six months are allowed for completion of the station; and if at the expiration of that period the station has not been completed, the applicant may file an application for an extension of time.

On completion of the construction and testing, application for station license is made on Form 403.

Experimental station licenses are issued for a period of one year.

Every station is required to keep an accurate log and to file with each application for renewal a report showing:

- A. Ultimate objective to be reached by experiments.
- B. General results accomplished during period of report, including references to published reports of experimental work.
- C. Technical studies in progress at time of filing report.
- D. Any major changes in equipment.
- E. Total hours of operation.

BOUND

To Give
Greater Value

A BINDER

For a Year's Copies of

"RADIO"

... and it holds your copy of the great annual "Handbook" by "Radio" in addition! Brilliant, durable red imitation leather, with the "Radio" name embossed in gold. Each magazine or book can be inserted or removed separately at will.

Makes a real radio library of your literature from "Radio", for permanent reference, easily consulted at any time.

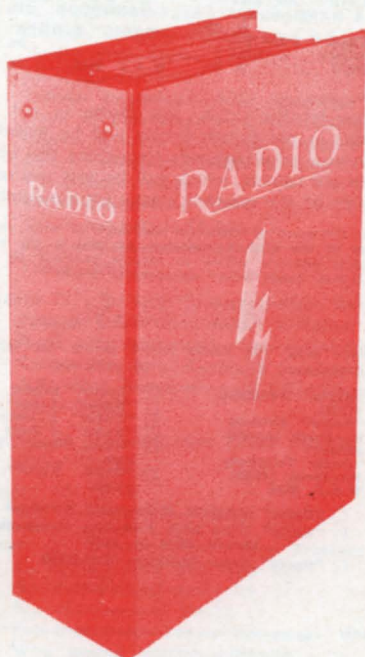

\$1.00

Postpaid
in U.S.A.

Foreign, \$1.25 or 5s. 3d.

RADIO
LIMITED

TECHNICAL PUBLISHERS - 7460 BEVERLY BLVD. - LOS ANGELES

To our Customers in the

BRITISH EMPIRE

Canada

For the convenience of our customers in Canada, we accept²⁵ Canadian postal notes at par; add 10c exchange to Canadian cheques under \$2.50. Canadian currency is acceptable but is sent at your risk.

Elsewhere

For the convenience of our customers in most other parts of the Empire, we accept²⁵ British postal orders and cheques payable at par in London, at the following prices, postpaid (prices subject to change without notice):

RADIO, 1 year (10 issues)	14s. 6d.	"RADIO" AMATEUR NEWCOMER'S HANDBOOK ..	1s. 8d.
RADIO, 2 years, 25s.		"RADIO" U.H.F. HANDBOOK ..	2s. 6d.
RADIO DIGEST, 12 issues	12s. 6d.	"RADIO" NOISE REDUCTION HANDBOOK ..	1s. 8d.
"RADIO" HAND-BOOK	7s.	"RADIO" BINDER ..	5s. 3d.
"RADIO" ANTENNA HANDBOOK, 3s. 6d.		W.A.Z. Map	1s.
"RADIO" TELEPHONY HANDBOOK	3s. 6d.		

Prices for the U.S.A. and territories not included in the British Empire will be found in individual advertisements throughout this book, or in our catalog, which will be sent you upon receipt of a three-cent stamp (or equivalent).

* In the event of restricted exchange or wide variations in the rate of exchange we reserve the right without advance notice to require payment in full in U.S.A. funds before shipment of goods.

ORDER BLANK

Please send the items listed below for which find enclosed \$..... in payment.

- | | |
|--|--|
| <input type="checkbox"/> "Radio" Handbook (1939) | <input type="checkbox"/> "Radio" Binder |
| <input type="checkbox"/> "Radio" Antenna Handbook (second edition) | <input type="checkbox"/> "Radio", 1 year |
| <input type="checkbox"/> "Radio" Telephony Handbook (1938) | <input type="checkbox"/> "Radio", 2 years |
| <input type="checkbox"/> W.A.Z. Map | <input type="checkbox"/> "Radio", 3 years |
| | <input type="checkbox"/> "Radio Digest", 6 issues |
| <input type="checkbox"/> "Radio" Amateur Newcomer's Handbook | <input type="checkbox"/> "Radio Digest", 12 issues |
| <input type="checkbox"/> "Radio" Ultra High Frequency Handbook (Ready early in 1939) | |
| <input type="checkbox"/> "Radio" Noise Reduction Handbook. | |

Name

Call

Address

RADIO, LTD.

Technical Publishers

7460 Beverly Blvd. Los Angeles

Dress up your Station

W. A. Z. MAP

Size 34" x 28"



A MAP OF THE WORLD FOR ONLY 25c!

Size: 34" x 28"

Heavy white paper

This is an enlarged reproduction of the W.A.Z. map which appears on pages 510 and 511 of this book. List of countries within each zone is also included.

The W.A.Z. plan is the best "yard-stick" yet developed for the measurement of DX achievement.

TWENTY FIVE CENTS

postpaid, anywhere. Canadian postal notes (25c) and British postal orders (1s.) accepted. Five international postal reply coupons accepted as 25c.

RADIO, LTD.

Technical Publishers

7460 Beverly Blvd. Los Angeles

Buyer's Guide

PARTS REQUIRED FOR BUILDING EQUIPMENT SHOWN IN THIS BOOK

The parts listed are some of those actually used by "Radio's" laboratory in constructing the models shown. Other parts of equal merit and equivalent electrical characteristics may usually be substituted without materially affecting the performance of the units.

CHAPTER 4—ANTENNAS

Figure 32. Universal Antenna Coupler

C—Cardwell XT-210-PD
Standoff Insulators—Birnbach 966 and 966J
Coils—Decker

CHAPTER 6—LEARNING THE CODE

Figure 5. Headphones—Trimm "Featherweight" Code Machine—Page 147—Instructograph

CHAPTER 8—RADIO RECEIVER CONSTRUCTION

Figure 1. RK43 Receiver Dial—Bud

Figure 3

C₁—Hammarlund MEX
C₂—Hammarlund MC-15M
C₃, C₄—Hammarlund MC-100M
RFC—Hammarlund CHX
T—Stancor A72C

Figure 6. Coil data Coil Forms—Hammarlund XP

Figure 9

C₁—Hammarlund MEX
C₂—Hammarlund SM15
C₃—Hammarlund SM100
R₂, R₅—Yaxley Universal
Tubular and Mica Condensers—Solar
Carbon resistors—Centralab
Tubes—RCA

Figure 11. Coil Table Coil Forms—Hammarlund XP

Figure 12. T.R.F. Receiver Dial—Crowe

Figure 15. T.R.F. Receiver Ceramic Sockets—Hammarlund S-4 and S-5 Tuning Condensers—Hammarlund MCD Tubes—RCA

Figure 18

C₁—Bud 833
C₂, C₁₀—Bud 913
C₃—Bud 900
C₄—Bud 905
R₃, R₆—Centralab

Tubular condensers—Cornell-Dubilier "Shielded Mike"

Carbon resistors—Centralab
Dials—Crowe
IFT—Meissner 1600 kc.
Tubes—RCA

Figure 20. Ultra Gainer Receiver Dial—Crowe

Figure 22. Ultra Gainer Circuit

C₁, C₆, C₂₂—Bud 926
C₁₀—Hammarlund SM15
R₁₀, R₁₃, R₂₄—Yaxley Universal
Ceramic sockets—Hammarlund S-5
Tuning dial—Crowe 526
LS—"Selectosphere"

Tubular condensers—Solar "Sealdtite"
Fixed mica condensers—Cornell-Dubilier
Carbon resistors—Centralab Insulated
Coil Forms—Hammarlund CF-5-M
T₁—Stancor A-331
RFC—Hammarlund CH-X
T₂—Hammarlund ST-465-CT
T₃, T₅—Hammarlund ST-465
Tubes—RCA

Figure 25. De Luxe Communications Receiver

Tubular Condensers—Solar "Sealdtite"
Fixed mica condensers—Cornell-Dubilier
Carbon Resistors—Centralab insulated
A.F. Input Transformer—U.T.C. "Chromshield"
Tubes—RCA

Figure 26. Superselective Phone Receiver Dial—Crowe

Figure 27. Same Coil Sockets—Hammarlund type S

Figure 28. Superselective Phone Receiver Circuit

C₁, C₃, C₂₅—One Bud type 886
C₂—Hammarlund APC—25
C₂₀—Hammarlund SM-25
Potentiometers—Yaxley Universal
Wire wound resistors—Ohmite
Carbon Resistors—Centralab
Tubular Condensers—Cornell-Dubilier "Dwart Tiger"
CH₁—United Transformer CS39
T₁ to T₆—Meissner iron core
Tuning dial—Crowe type 296
RFC—Hammarlund CH-X
Tubes—RCA

Figure 32. Supersensitive Receiver Circuit

C₁—Hammarlund MC20S
C₂—Hammarlund HF15

C₃—Hammarlund HF50
Carbon resistors—Centralab insulated
Wire wound resistors—Ohmite
Tubular condensers—Solar "Sealdtite"
Mica condensers—Solar type MW
Potentiometers—Yaxley Universal type
Coil Sockets—Hammarlund S5
Tubes—RCA

Figure 35. 5-Meter Super Gainer
C₁—Hammarlund MEX Trimmer
C₂, C₃—Hammarlund HF-15
C₄—Hammarlund APC 50 μfd.
Tubular and mica by-passes—Cornell-Dubilier
Flexible shaft couplings—Bud 795
R₅—Centralab 72-103
R₇—Centralab 72-107

Figure 42. Preselector Circuit
C₁, C₂—Bud type 903
Cabinet—Bud 870
Coil Sockets—Hammarlund S5
Tuning Dial—Crowe 124
Tubular Condensers—Cornell-Dubilier "Dwarf
Tiger"
Shaft Coupling—Bud 795
Tube—RCA

CHAPTER 11—TRANSMITTER THEORY

Figure 21
Vacuum Tank Condenser—Eimac

CHAPTER 12—EXCITERS

Figure 7. 6L6G Tritet
Coil Forms—Hammarlund XP
Crystal—Bliley
Tube—RCA

Figure 8. 76 Regenerative Oscillator
R—Centralab
C₂—Cornell-Dubilier
RFC—Hammarlund CH-X
Tube—RCA

Figure 13
Boosted Pierce Exciter
Coil Form—Hammarlund XP
Crystal—Bliley B5
Ceramic Sockets—Hammarlund type 5

Figure 15. Boosted Pierce Exciter Circuit
Sockets—Hammarlund
C₇—Hammarlund SM100
RFC—Hammarlund CH-X
R₃—Ohmite Brown Devil
Crystal—Bliley LD2 (80-, 160-M.) or B5
(40-M.)
Tubular Condensers—Solar
Mica Condensers—Cornell-Dubilier
Tubes—RCA

Figure 16. 76-6L6G Exciter
Coil Forms—Hammarlund XP
Standoff Insulators—Birnback
Tubes—RCA

Figure 17. 76-6L6G Exciter
Wirewound Resistors—Ohmite
Tubular condensers—Solar "Sealdtite"
Tubes—RCA

Figure 18. 76-6L6G Circuit
C₁, C₃, C₈—Hammarlund "Star"
RFC—Hammarlund CH-X
Jacks—Bud
R₃—Ohmite Brown Devil
Tubes—RCA

Figure 21. 6J5C-6L6G Exciter Circuit
S—Yaxley 1316-L
J₁, J₂—Yaxley junior type
R₃—Ohmite Brown Devil
Coil Forms—Hammarlund XP53
Tubes—RCA

Figure 24. 3-Tube Self-Tuned Exciter Circuit
S—Yaxley type 1315-L
J₁, J₂, J₃—Centralab midget
RFC—Hammarlund CH-X
R₃, R₅—Ohmite Brown Devil
Carbon Resistors—Centralab
Tubes—RCA

Figure 29. Push-Pull 6L6G Exciter Circuit
C₂—Bud 903
C₇—Hammarlund MCD-100-M
C₁₃—Bud 898
Mica Condensers—Aerovox 1450
Shaft Couplings—Hammarlund type FC
Carbon Resistors—Centralab
Wire Wound Resistors—Ohmite Brown Devil
RFC—Bud type 920
Tubes—RCA

Figure 32. 6L6G-809 Exciter Circuit
C₄—Hammarlund SM-100
C₈—Hammarlund MC-50-MX
RFC—Hammarlund CH-X
J₁, J₂, J₃, J₄—Yaxley midget type
R₂—Ohmite Brown Devil
Midget Tank Coils—Decker
Tubes—RCA

Figure 27. Dynapush Exciter
10-watt resistors—Ohmite
RFC₁—Hammarlund CH-X
RFC₂—Hammarlund CH-X
(2.1 mh.) or Hammarlund CH8
(8 mh. for 160 M.)
C₃, C₄, C₅—Hammarlund SM-50-X ("Star")
Mica Condensers—Aerovox type 1450
Coil Forms—Hammarlund XP-53; 10-meter
form preferably CF-5-M
Switch—Centralab no. 1461 tone switch or
Yaxley no. 60 jack switch
Jacks—Yaxley type 702
Crystal—Bliley B-5
Tubes—RCA

CHAPTER 13—C. W. TRANSMITTER
CONSTRUCTION

Figure 2. T20 Amplifier
Coil Form—Hammarlund XP
Ceramic Sockets—Hammarlund type 5

Crystal—Bliley
Tube—Taylor T20

Figure 4. 100-Watt T40 Transmitter

Crystal—Bliley
Coil Forms—Hammarlund XP
Air Wound Coil—Barker & Williamson
Ceramic Sockets—Hammarlund type S
Tubes—Taylor T40, RCA 6L6G

Figure 5. 100-Watt T40 Transmitter

Tubular Condensers—Solar
Resistors—Ohmite
R.F. Chokes—Hammarlund CH-X
Tubes—Taylor T40, RCA 76, RCA 6L6G

Figure 6. 3-Stage T40 Transmitter Circuit

C₁, C₄—Hammarlund "Star"
C₁₁—Bud type 567
C₁₆—Cardwell MT-100-GS
Wire Wound Resistors—Ohmite Brown Devil
J₁₋₄—Centralab midget type
Tubular Condenser—Cornell-Dubilier "Shielded Mike"
C₁₄—Cornell-Dubilier type 9
RFC—Hammarlund CH-X
Tubes—Taylor T40, RCA 76, RCA 6L6G

Figure 8. Push-Pull 809 Transmitter

C₄—Bud 903
C₉—Hammarlund MS-50-SX
C₁₆—Bud type 1553
Wire Wound Resistors—Ohmite Brown Devil
Mica Condensers—Aerovox type 1450
Tubular Condensers—Solar "Sealdtite"
Carbon Resistors—Centralab
J₁₋₄—Centralab midget type
Sockets—Hammarlund type S
Tubes—RCA 76, 6L6G, 809's

Figure 14. De Luxe 10-Meter Transmitter

C₃, C₄—Solar "Domino's"
C₈—Bud no. 898 condenser
C₉—Cardwell MT50GD
C₁₀—Bud no. 92 condenser
RFC₁—Hammarlund CH-X
RFC₂—Hammarlund CH-500
Sockets—Hammarlund
Crystal—Bliley B-5
Tubes—Taylor T40's and TZ20, RCA 6L6G's

Figure 17. 400-Watt Transmitter

C₄—Hammarlund SM-100
C₉, C₁₀—Hammarlund MC-50-SX
C₁₆, C₁₆—Cardwell type ADN
C₁₇—Cardwell XC-40-XD
J₁₋₄—Yaxley midget type
Wire Wound Resistors—Ohmite Brown Devil
Carbon Resistors—Centralab
Mica Condensers—Cornell-Dubilier type 9
Tubular Condensers—Solar "Sealdtite"
RFC—Bud type 920
RFC₁—Bud type 876
Tubes—Heintz & Kaufman HK54's, RCA 809 and 6L6G

Figure 18 and figure 19 (p.p. 35T's)

C₁—Cardwell MT-70-GD
C₂—Cardwell XC-50-KD
T₁—U.T.C.
Tank Coils—Decker Mfg. Co.
Tubes—Eimac 35T's

Figure 18 and figure 20 (p.p. HK54's)

C₁—Cardwell MT-70-GD
C₂—Cardwell XC-50-KD
C₃, C₄—Hammarlund N-10
Tank Coils—Decker Mfg. Co.
Tubes—Heintz & Kaufman HK54's

Figure 18 and figure 21 (p.p. 100TH's)

C₁—Cardwell MT-100-GD
C₂—Cardwell XC-40-XD
C₃, C₄—Cardwell type ADN
Tubes—Eimac 100TH's

Figure 18 and figure 22 (p.p. HF100's)

C₁—Cardwell ER-35-AD
C₂—Cardwell NP-35-ND
C₃, C₄—Home Made
T₁—U.T.C. S-62
Tubes—Amperex HF100's

Figure 18 and figure 23 (p.p. T200's)

C₁—Cardwell MT-50-GD
C₂—Cardwell TL-50-UD
T200's—Taylor
HF300's—Amperex

CHAPTER 15—RADIOPHONE TRANSMITTER CONSTRUCTION

Figure 4. R.F. Unit

Coil Form—Hammarlund XP
Tuning Condenser—Cardwell
Crystal—Bliley
Tubes—RCA

Figure 7. T40 Transmitter

Tubular Condensers—Solar "Sealdtite"
Mica Fixed Condensers—Cornell-Dubilier type 9
Wire Wound Resistors—Ohmite
Carbon Resistors—Centralab
C₂—Mallory type CTX-956
C₅—Hammarlund MC-50-MX
C₇—Bud type 567
C₈—Cardwell MT-70-GD
R₉—Yaxley universal type
RFC—Bud type 920
RFC₁—Bud type 876
T₁—Stancor P-4090
T₂—Stancor P-3060
T₃—Stancor P-5050
T₄—Stancor A-4702
CH—Stancor C-1412
Crystal—Bliley LD2 for 160 and 80 M., B5 for 40 and 20., HF2 for 10 M.
Ceramic Sockets—Hammarlund type S
Tubes—Taylor T40's and 866-Jr.'s, RCA 6L6G, 6V6, 6J7 and 6C5

Figure 10. 75-Watt 809 Phone

C₃, C₃, C₁₄—Hammarlund "Star"
C₁₅—Bud type 898
C₁₇, C₁₈—Cardwell "Trim-Air"
C₁₆—Bud type 1553
Ceramic sockets—Hammarlund type S
A.F. and Power Supply Transformers and Chokes—Stancor
Tuning Dials—Bud type 165
Mica Condensers—Cornell-Dubilier type 9

Tubular Condenser—Solar "Sealdite"
Crystal—Bliley type LD2 or B5
RFC—Bud type 920
RFC₁—Bud type 876
Electrolytic filter condensers—Cornell-Dubilier
Electrolytic by-pass condensers—Mallory
R₁₆, R₂₆—Yaxley universal type
Wire Wound Resistors—Ohmite
Carbon Resistors—Centralab insulated
Tubes—RCA

Figure 14. Dual Power Supply
Transformers and Chokes—Stancor

Pg. 399. ZB120 Modulator
Input Transformer—U.T.C. PA53AX
Output Transformer—U.T.C. VM4
Tubes—Amperex ZB120

Figure 16. Final Amplifier
Tuning Condenser—Bud 93
Coils—Decker
Neutralizing Condensers—Bud 892
Tubes—Heintz & Kaufman HK254's

Figure 19. A.F. Channel
Output Transformer—Thordarson CHT
Input Transformer—Thordarson
Bias Cell—Mallory
Tubes—Taylor 203Z, RCA 6J7, 6C5G and 2A3's.

Figure 20. Power Supply
Transformers and Chokes—Thordarson
Tubes—RCA

Figure 18. HK54 Transmitter
Crystal—Bliley
Ceramic Sockets—Hammarlund type S
Standoff Insulators—Birnbach
Tuning Condenser—Bud
Coil Form—Hammarlund XP
Tubes—Heintz & Kaufman HK54, RCA 6L6G

Figure 22. 400-Watt Phone Circuit
All Variable Condensers—Bud Radio, Inc.
All Mica Fixed Condensers—Cornell-Dubilier type 9
All Paper By-pass Condensers—Solar Domino
Electrolytic Condensers—Mallory-Yaxley
Ceramic Sockets—Hammarlund type S
All Wire Wound Resistors—Ohmite
All Carbon Resistors—Centralab insulated type
Tubes—Heintz & Kaufman HK254's or Eimac 100TH's, Heintz & Kaufman HK54 or Eimac 35T, Taylor 203Z's. All others RCA

RFC—Bud type 920
RFC₁—Bud type 569
R₁₃, R₂₁—Yaxley universal type
Tuning Dials—Bud type 165
Coil Forms—Bud type 126
C₃₃, C₃₄, C₃₅—Mallory oil type
All A.F. and Power Transformers and Chokes—Thordarson
Crystal—Bliley LD2 or B5

Figure 26. Kilowatt Phone
All condensers—Aerovox
C₁—Aerovox EM25 10 μ fd.
C₂, C₃—PBS5 8-8 μ fd.
C₄—PR25 10 μ fd.
R₂₄—Centralab 72-115

C₄, C₁₁—Hammarlund "Star"
C₁₀—Hammarlund MTCB-100-B
RFC—Bud h.f. chokes
BC—Mallory bias cell
Mica Condensers—Cornell-Dubilier
Electrolytic Condensers—Solar
Paper Condensers—Aerovox
Relay—Leach Relay Mfg. Co.
Carbon Resistors—Centralab
Wire Wound Resistors—Ohmite
Ceramic Insulators—Birnbach
Jacks, Switches, and Potentiometers—Mallory—Yaxley

T₁—U.T.C. PA-238-AX
T₂—U.T.C. type VM-5 Varimatch
T₃—U.T.C. type S-54
T₄, T₅—U.T.C. type S-59
T₆—U.T.C. type DS-2
T₇—U.T.C. type S-72
T₈—U.T.C. type PA-110
T₉—U.T.C. type PA-114
T₁₀—U.T.C. type S-60
CH₁—U.T.C. type S-25
CH₂—U.T.C. type S-31
CH₃—U.T.C. type S-34
CH₄—U.T.C. type S-32
CH₅—U.T.C. type S-35
CH₆—U.T.C. type S-37
Tubes—Eimac 35T and 100TH's or Heintz and Kaufman HK54 and HK254's. All others RCA

Figure 28. A.F. Driver
Output Transformer—U.T.C. VM3
6L6G Tubes—RCA

Figure 30. High-Voltage Filter
Upright Choke—U.T.C.

Figure 32. Peak Compressing Amplifier
T₁—Thordarson 81D42
T₂—Thordarson 15D79
T₃—Thordarson 11M77
T₄—Thordarson 70R62
T₅—Thordarson 16F13
CH₁—Thordarson 74C29
CH₂—Thordarson 13C28
All tubular condensers—Cornell-Dubilier
All filter and coupling condensers—Cornell-Dubilier
Tubes—RCA

CHAPTER 16—U.H.F. COMMUNICATIONS

Figure 14. 1-10 M. Receiver
30-Henry Midget Choke—Stancor
100,000 and 500,000-ohm Potentiometers—Centralab
.006 and .00025- μ fd. mica condensers—Cornell-Dubilier
10- μ fd. electrolytic condenser—Aerovox
Other condensers—Solar
Carbon Resistors—Centralab insulated
955 and 6V6G Tubes—RCA

Figure 18. Crystal Controlled U.H.F. Transmitter
C₁—Bud type 891
RFC—Bud type 925
R₁, R₂, R₃—Ohmite Brown Devil

C₂, C₃—Solar type XM
Tubes—RCA

Figure 19. C.C. Transmitter Circuit

C₃, C₅—Hammarlund MC-20-S
C₁, C₂, C₄—Cornell-Dubilier type W
C₆—Cornell-Dubilier type 9
RFC—Hammarlund type CHX
R₁, R₂—Centralab
Crystal—Bliley HF2
Tubes—RCA

Figure 21. U.H.F. Exciter

Crystal—Bliley Variable-Frequency
Coil Forms—Hammarlund XP
Tubes—RCA

Figure 22. Hi-Power U.H.F. Transmitter Circuit

C₆—Bud type 903
C₁₂—Bud type 905
C₁₇, C₁₈—Hammarlund MCD-50-MX
C₂₄—Cardwell NP-35-ND
Mica Condensers—Cornell-Dubilier type 9
Tubular Condensers—Solar "Sealdtite"
RFC—Bud type 920
RFC₁—Bud type 876
Carbon Resistors—Centralab
Wire Wound Resistors—Ohmite
Crystal—Bliley VF-1
Tubes—Eimac 35T

Figure 25. Parallel Rod Transmitter

Tubes—Eimac 35T
Ceramic Sockets—Hammarlund type S

Figure 40. 90-Cm. Transceiver

C₁—Cardwell 15- μ fd. Trim-Air
Type 955 and 30 Tubes—RCA
CH—Stancor C-1413

CHAPTER 17—POWER SUPPLIES

Figure 28. High-Voltage Supply

Transformers—Thordarson CHT
Chokes—Thordarson CHT
Condensers—Aerovox

Figure 29. 1750-Volt Supply

Filament Transformer—Thordarson
Filter Condensers—General Electric Pyranol

CHAPTER 18—TEST EQUIPMENT

Figure 2. Absorption Wavemeter

Coil Form—Bud type 126
Condenser—Bud type 906

Figure 3. Field-Strength Meter

Variable Condenser—Hammarlund "Star"
Coil Form—Bud type 906
Tube—RCA

Figure 11. Frequency Meter-Monitor

C₁, C₂—Hammarlund MC-150-B
CH—Thordarson midget
C₁₁, C₁₂—Aerovox PBS type
Resistors—Centralab insulated type
Mica Condensers—Cornell-Dubilier type W

Tubular Condensers—Solar "Sealdtite"
Tubes—RCA

Figure 15. C.W. Monitor

Dial—Bud
Tube—RCA

Figure 17. C.W. Monitor

C₂—Hammarlund SM-50
RFC—Hammarlund CH-X
S₁—Centralab selector type
R₁, R₂—Centralab
Tube—RCA

Figure 20. Phone Test Set

S₁—Yaxley selector type
C₁—Bud type 906
Dial—Crowe type 292

Figure 22. Ohmmeter

Resistors—Ohmite

Figure 39. Cathode-Ray Modulation Checker

Resistors—Centralab carbon
T—Thordarson T-92R33
C₂—General Electric Pyranol type
R₂₁, R₃, R₄—Yaxley universal type
C₁—Solar "Domino"
Tubes—RCA

Figure 41. Oscilloscope with Complete Sweep Circuits

R₆, R₂₂—Yaxley Y50MP
R₈—Yaxley UC506
R₁₃—Yaxley UC504
R₂₀—Yaxley Y500MP
R₂₁—Yaxley Y25MP
R₂₀, R₃₀—Yaxley Y100MP
All Tubulars—Aerovox 484
Filter condensers—Aerovox CL450
C₆—Aerovox PBS200
SW₂—Yaxley 3215J
SW₄, SW₅—Yaxley 3234J
Resistors—Centralab insulated type
All Tubes RCA

CHAPTER 19—RADIO THERAPY

Figure 2. De Luxe Diathermy R.F. Unit

L₂, L₃—Barker and Williamson Type 10HDVL
with Base
All Fixed Condensers—Cornell-Dubilier
C₂—Cardwell Type JD-28-ND
C₆—Cardwell Type XC-100-XS
RFC—Hammarlund CH-500
Tubes—Amperex HF200's

Figure 3. De Luxe Diathermy Power Supply

T₁—U.T.C. PA-34
T₂—U.T.C. PA-114
T₃—U.T.C. PA-126
T₄—U.T.C. FT-2
Overload Relay—Ward-Leonard 507-512
Thermal Time-Delay Relay—Ward-Leonard
507-501
Cabinet—Par-Metal
Insulators—Birnbach
Tubes—Amperex 866

Index

A

- Abbreviations 522, 530, 540, 552
Absorption Wavemeter 414, 461
Acorn Tubes 421, 416
Adjustment of Receivers 165
A. F. Peak Limiters 163, 164, 367
Air Core 19
Air Gap, Filter Choke 443, 458
Air Gap, Tuning Condenser 275
Alignment, Receiver:
 Multiband 169
 Superheterodyne 165
 Tuned R. F. 165
Alphabet, Greek 17
Alternating Current 16
Alternator 27
Aluminum Drilling 134
Aluminum Q Bars 85
Amateur Bands 496
Amateur Licenses 491
Amateur Regulations 491
Ampere 8
Ampere Turns 18
Amplification 265
Amplification Factor 43
Amplifier:
 A. F. 42, 43, 153, 350
 Beam Power 350
 Class-A 43, 234
 Class-AB 45, 350
 Class-B 46
 Class-BC 357
 Class-C 46
 Degenerative Feedback (See—Inverse Feedback)
 Gain 54, 349
 I. F. 155, 156, 166
 Input 348
 Linear 46
 Parallel Rod 431
 Parallel Tube 285
 Push-Pull Tube 58, 276, 285, 401
 Ratings 54
 R. F. 46, 269
 Series-Fed 285
 Shunt-Fed 285
 Speech 346, 349, 350, 351, 364, 369-371, 398, 401, 405
 Voltage 56
 Amplitude 16, 344
Amplitude Modulation 345
Angle of Plate Current Flow 272
Angle of Radiation 61
Angular Velocity 28
Antenna Couplers 80, 97
Antenna Coupling 88
Antenna Directivity 66
Antenna Impedance 71
Antenna Insulation 128
Antenna Radiation 62
Antennas:
 Balancing Coils 126
 Broadside Radiation 106
 Colinear 108
 Current-Fed 71
 Dipole 62
 Directional Arrays:
 Aperiodic Long-Wire 99
 Bi-Square 114
 Bruce 111
 Close-Spaced 119
 Colinear 108
 Diamond 103
 Kraus Flat-Top 112
 Multiple-Stacked Broadside 109
 Reinartz 116
 Rhombic 103
 Rotatable Arrays 117
 Stacked Dipole 106
 Unidirectional 115, 118
 V Antenna 101
 Delta-Matched 77
 Directors 118
 Distributed Characteristics 63
 Dummy 97
 Electrical Length 63, 70
 End-Fed 68
 End-Fire Directivity 112
 Feeders 71
 Field Patterns 67, 98, 104, 105, 106, 107, 108
 Franklin 108
 Formulas 77, 79, 81, 84, 87, 88
 Fuchs 68
 Fundamental Frequency 63
 Guy Wires 126
 Harmonic Resonance 63
 Height 65
 Horizontal 67
 Inverted-L Type 71
 J-Type 87
 Hertz 65
 Johnson-Q 84
 Marconi 62, 69, 71
 Mobile U. H. F. 123
 Radiation 61
 Radiation Resistance 63
 Receiving 124
 Reflectors 115, 116
 Resonant 153
 Single-Wire-Fed 78
 Tuned Doublet 73
 U. H. F. 121, 413
 Vertical 67
 Voltage-Fed 71
 Wavelength Relations 70
 Y-Matched Type 80
 Zepp 72
Antilogarithm 55
Apparent Power 30
Arrays (See—Antennas, Directional Arrays)
AT-Cut Crystals 293-297
Atoms 7
Atomic Number 7
Attenuation 66
Audio Block Diagrams 323
Audio-Frequency Amplifiers 42, 153, 346, 349, 350, 351, 364, 369-371, 398, 401, 405
Audio Gain Calculations 351
Audio Oscillators 144, 145
Autodyne Detector 153
Automatic Bias 279
Automatic Frequency Control 157
Automatic Key 148
Automatic Keying 146
Automatic Modulation Control 367
Automatic Volume Control 156, 157
Autotransformer 36
A. V. C. Effect in Superregenerative Circuits 412
Average Power 354
Axis, Crystallographic 293

B

Back E. M. F. 18, 20
Balancing Coils 126
Bandset Condenser 153
Bandspread:
 Electrical 152
 Mechanical 152
 Tuning 151
Bandswitching 169
Barrage Array 108
Bass Suppression 354
Battery Bias 279
Beam Power Amplifier 350
Beam Power Tubes 50
Beams (See—Antennas, Directional Arrays)
Beat-Frequency Oscillator 158
Beat-Frequency Oscillator Adjustment 166
Bel 52
Bias:
 Automatic 279
 Battery 279
 Cathode 279
 Cutoff 266
 Definition 42
 Doublor 267
 Grid-Leak 279
 Separate Supply 280, 447
"Birdies" 315
Bi-Square Beam Antenna 114
B-K Oscillator 415
Bleeder Resistor 12, 24, 444
Blocked-Grid Keying 288
Boosted Pierce Exciter 303
Brass Drilling 133
Breadboard Construction 130
Breakdown, Dielectric 22
Breakdown Ratings of Transmitting Condensers 276
Bridge Rectifier 443
Broadcast Interference 292
Bronze Drilling 133
Bruce Antenna 111
Brute-Force Filter 441
Buffers 235-238, 242-244, 265
 Neutralized 266
Bug Key 148
Buzzers, Code Practice 143
B5-Cut Crystals 293
By-Passing 264

C

"C" Value for Crystal Oscillator Tanks 295
Calibration:
 Frequency Meter 415, 465
 Monitor 465
 Oscilloscope 480
 Phone Test Set 471
 Signal Generator 478
 V. T. Voltmeter 476
 Wavemeter 415
Capacities:
 Circuit 154
 Interelectrode 50
Capacitive Coupling 90, 150, 280
Capacitive Reactance 151
Capacity:
 Calculation of 22
 Definition 21
 Distributed 151
 Formulas 22, 23
 Tank Circuit 271
Carbon Microphone 346, 347
Carrier Power 344
Carrier Shift 345
Cathodes 40

Cathode Bias 279
Cathode Current 40
Cathode Ray Oscilloscopes 478
Cathode Regeneration 268
C-L Ratio 34, 204, 271
Center-Tap Keying 290
Center-Tapped Resistor 264
Characteristic, of Logarithm 52
Characteristics, Tube:
 Receiving 213
 Rectifiers 262
 Transmitting 230

Charts:

Amateur Abbreviations 552
Antenna Field Patterns 98, 102, 104, 105, 106, 107
Bleeder Resistors 445
Block Diagrams:
 Combined C. W. and Phone 325
 C. W. 321
 Radiophone 323
 Speech Amplifier-Modulator 370
Bruce Antenna Design 111
Circular Plate Condensers 22
Coil Inductance 536
Coil Tables (These are included in all Construction Chapters)
 Colinear Antenna Design 109
 Color Code (R.M.A.) 530
 Condenser Air Gap 276
 Condenser Breakdown Voltages 276
 Continental Code 143
 Copper Wire Tables 454, 455
 DB-Power Levels 57
 DB-Power Ratios 53
 DB—Voltage Ratio 570
 Delta Matched-Impedance Antenna Dimensions 81
 Diamond Antenna Design 104
 Dielectric Constants 22
 Drill Sizes 133
 Field-Strength Meter Dial 464
 Filter Choke Design 457
 Flat-Top Antenna Design 114
 Frequency Meter Curve 467
 Greek Alphabet 17
 International Prefixes 562
 J-Antenna Dimensions 87
 L-C Data 273, 374
 Logarithmic Alignment Nomogram 534
 Logarithms 54, 55
 Long-Antenna Design 100
 Microphone Levels 58
 Modulated Class-C Input Values 353
 Oscilloscopic Patterns 481
 Q-Antenna Dimensions 87
 Q-Bar Dimensions 86
 Q Signals 522
 Radiation Resistance 100
 Radio Symbols 530
 Rectifier-Filter 446
 Relay Rack Dimensions 140
 R. F. Feeder Losses 76
 R-S-T Reporting System 552
 Selectivity 32
 Series Circuit Reactance-Frequency Variation 31
 Single-Wire-Fed Antenna Dimensions 87
 Socket Connections 226
 Stacked Dipole Design 110
 Stub Length 83
 Surge Impedance:
 Coaxial Line 77
 Multiconductor Transmission or Matching Transformer 89
 Open Line 74
Tools 131
Tube Tables:
 F.C.C. 542

584
RADIO
Handbook

Microwave Tubes	416	Vacuum-Type	277
Receiver Types	213	Conductance	8
Rectifier Types	262	Conductance, Mutual	20
Transmitting Types	230	Conductivity	8, 17
V-Antenna Design	101, 102	Conductors	7
Volt-Ohmmeter Dial	472	Connections, Tube Socket	227, 228
Wire Diameters	75	Contact Noise	412
Wire Tables	454, 455, 540	Continental Code	143
Chassis Building:		Continuous-Coverage T. R. F. Receiver	177
Assembly	135	Control, Single-Dial	204
Folding	135	Controlled Carrier	363
Layout	132	Construction:	
Metal	130	Breadboard	130
Plating and Painting	136	C. W. Transmitter	327
Punching	134	Hints	132
Choke, Core Material	19	Metal Chassis	130
Choke, Filter	440, 443	Radiophone Transmitter	372
Choke Input	440	Radio Receiver	171
Choke Design	457	Relay Rack	139
Choke, R. F.	283	Conversion Exciter	284, 316, 318
Choke, Smoothing	443	Conversion Table	518
Choke, Swinging	443	Conversion Transconductance	51
Circuit:		Converter:	
Analysis	263	Frequency	50
Capacities	154	Pentagrid	50
Neutralizing	268	U. H. F.	202
Noise-Balancing	161	Copper Wire Tables	454, 455
Noise-Limiting	162	Core, Air	19
Push-Pull Audio	45	Core Losses	451
Push-Pull R. F.	269	Core Material	19, 451
Resonant	150	Core, Powdered Iron	20
Circulating Tank Current	34	Core Saturation	17, 452
Class-A Amplifier	43, 234	Coulomb	8
Class-A Modulator	250, 256, 356	Counter E. M. F.	18, 20
Class-AB Amplifier	45, 231, 232	Counterpoise	69
Class-AB Modulator	350	Coupling:	
Class-B Amplifier	46, 233, 242, 247, 249, 253	Antenna to Transmitter	88
Class-B Bias	269	Capacitive	91, 150, 280
Class-B Modulator	232, 242, 368	Coefficient of	19
Class-B Voltage Regulation	368	Effect on Plate Circuit	35
Class-BC Amplifier	357	Impedance	45
Class-C Amplifier	46	Inductive	37, 91, 150, 281
Class-C Bias	269	Interstage	45
Clicks, Key	286	Link	38, 272
Close-Spaced Directional Array	119	Loops	292
Coaxial Line	76	Magnetic	37, 91, 150, 281
Code:		Resistance	372
Buzzer	143	R. F.	149, 150, 280 (See also listings under capacitive, inductive, etc.)
Correct Sending Position	146	Unity	39
Learning the	142	Cross Modulation	292
Practice Machine	147	Crystal Axes	293
Practice Oscillator	144, 145	Crystal-Controlled 5-Meter Transmitters	422, 424
Coefficient of Coupling	19	Crystal Current	294
Coil Tables (These accompany each of the Constructional Chapters)		Crystal Cuts	293
Coils	204	Crystal Filter	159, 160
Coils, Balancing	126	Crystal Filter Alignment	167, 170
Colinear Antenna	108	Crystal Holders	294
Colinear Antenna Design Chart	109	Crystal Microphone	347, 349
Collins Antenna Coupler	91	Crystal Oscillator	296, 297, 298, 300
Colpitts Oscillator	284	Crystal:	
Concentric Lines	76	Action in I. F. Amplifier	159, 160
Concentric-Pipe Oscillator	432	Axes	293
Condenser:		AT-Cut	293, 294, 297
Bandset	153	B5-Cut	293
Discharge	21	HF-2 Cut	293
Electrolytic	24, 444	High-Frequency	294
Energy Stored In	21, 22	Low-Drift	293
Filter	24, 444	Mechanical Activity of	293
Ganged Tuning	153	Rochelle Salt	347
Microphone	347	Special Cuts	293
Padder	153	Tourmaline	293
Parallel Connection	23	Twin Peaks	294
Series-Parallel Connection	24	Use and Care of	294
Trimmer	153, 166	V-Cut	293
Tuning	31		

X-Cut	294
Y-Cut	294
Current:	
Alternating	16
Cathode	40
Direct	9-15
Electric	8
In Dropping Resistor	9
Loops	62
Magnetic	17
Nodes	62
Peak	354
Plate	40
Cutoff Bias	266, 269
Cutouts, Chassis	134, 135
C. W. Block Diagrams	321
C. W. Keying	286
C. W. Monitor	468
C. W.-Radiophone Block Diagrams	325
C. W. Transmitter (See—Transmitters, C. W.)	
Cycle	16

D

Damping Action	412
Decibel-Power Chart	57
Decibels	52
Decibels to Power	55
Decibels (Voltage Ratio)	570
Degenerative Feedback Amplifier	364
Degeneration	363
Delta-Matched Impedance Antenna	77
De Luxe Communications Receiver	188
De Luxe Diathermy Machine	488
Demodulation	149, 345
Detection	48, 49, 149
Detector-Oscillator Alignment	168
Detectors	48, 153
Diathermy	484
Dielectric	21
Dielectric Breakdown	22
Dielectric Constant	22
Dielectric Stress	21
Dielectric Thickness	23
Difference of Potential	9
Diode	50
Direct Current	8-15
Direction of Current Flow	8
Directional Antennas (See—Antennas, Directional Arrays)	
Directional Effects of Crystal Microphone	349
Directive Properties of Antennas	97
Discharge, Condenser	21
Dissipation, Plate	45
Distortion	43, 48, 368
Distributed Capacity	151
Dividers, Voltage	11, 13
Double-Button Microphone	347
Doublers:	
Push-Push	267
Regenerative	234, 266, 268
Single-Ended	242, 248, 266
Tube Requirements	267
Doublet Antenna	73
Dow Oscillator	234, 235, 284
Drift, Frequency	294
Drilling	132, 133
Drill Sizes	133
Drop, Voltage	9
Dropping Resistor	9
Dual Triode Receiver	171
Dummy Antennas	97
Duralumin Diaphragm	347
Dynamic Characteristic	44
Dynamic Microphone	349
Dynapush Exciter	309
Dynatron	277

E

Eddy Current Losses	19, 20, 451
Effect, Piezoelectric	293
Effective Resistance	10
Effective Value	28
Efficiency Modulation	357
Efficiency, Tuned Circuit	150
Electrical Bandspread	153
Electric Current, the	8
Electric Power	11
Electrolytic Condensers	24, 444
Electromagnetic Component	60
Electromagnetism	17
Electromotive Force	8, 9
Electron	8
Electron-Coupled Oscillator	234, 235, 284
Electron Emission	40
Electron, Free	8
Electron Orbit Oscillator	415
Electron Ray Tube	158
Electrostatic Component	60
Electrostatic Coupling	90, 150, 280
Elimination of Harmonics	293
Elimination of Interference	286, 292
E. M. F.	9
Emission, Secondary	49
End-Fire Directivity	112
Energy Stored in Condenser	21, 22
Energy Stored in Magnetic Field	20
EO-1 Cable	75
Equivalent Circuit, Crystal Filter	159
Excitation, Grid	270
Excitation Keying	286
Exciters:	
Single-Tube:	
Harmonic 6A6	301
Jones Oscillator-Doubler	298
Pierce Oscillator	298
Push-Pull Crystal Oscillator	297
Regenerative All-Band	298
Regenerative 6L6G Oscillator	300
Regenerative 76 Oscillator	299
Reinartz Oscillator	301
Tritet	298, 299
6A6 Push-Pull Oscillator	297
42 Pentode Oscillator	297
47 Pentode Oscillator	297
Multi-Tube:	
Boosted Pierce	303
Dynapush	309
Flextal	315
Multiband 6L6G	304
Push-Push 6L6G	311
Three-Tube, Self-Tuned	307
Two-Tube, Self-Tuned	306
6L6G-809	313
Experimental License	571
External Cross Modulation	292

F

Factor of Merit	33
Fading	61
Farad	21
Faraday Screen	38, 93, 125, 207
Feed:	
Series	285
Shunt	285
Feedback	365, 368
Feeder Losses	76
Feeders, Antenna:	
Tuned	73
Untuned	74
Single-Wire	78
Fever, Induced by Diathermy	484
Fidelity	149

586
RADIO
Handbook

Field Strength Meter 461, 462
 Filament By-Passing 265
 Filter:
 Brute Force 441
 Chokes 443, 457, 458
 Choke-Input 440
 Circuits 440
 Circuit Considerations 442
 Condensers 24, 444
 Crystal 159, 160
 Decoupling 156
 Key-Click 286, 290
 Line 161
 Low Pass 441
 Pi-Section 93
 Power 440
 Resonant 441
 Five-Meter Antennas 123
 Five-Meter Super Gainer 201
 Five-Meter Superheterodyne 209
 Five-to-Ten-Meter Superheterodyne 204
 Flat-Top Beams 112, 113, 114
 Flexital Exciter 316, 318
 Flux 17, 451
 Flux Density 17, 451
 Flywheel Effect 35
 Folding, Chassis 135
 Four-Wire Q-Sections 86
 Franklin Antenna 108
 Free Electrons 8
 Frequency 16
 Frequency Converter 50
 Frequency Determination 413, 415
 Frequency Formula 31
 Frequency, Relation to Wavelength 62
 Frequency Control, Automatic 157
 Frequency Converters 50
 Frequency Drift 294
 Frequency Meters 464
 Frequency Modulation 346
 Frequency Multipliers 266
 Frequency Stability 284
 Full-Wave Rectification 41, 439
 Full-Wave Rectifier 41
 Full-Wave Three-Phase Rectifier 446
 Fundamental Radio Theory 7

G

Gain:
 A. F. Calculation 54, 349, 351
 R. F. 153
 Gainer Receiver 175
 Gaseous Conduction 41
 Generator:
 A. C. 26
 Signal 476
 Globe, Great Circle 518
 Great Circle Direction 117
 Greek Alphabet 17
 Grid 42
 Grid Bias 278, 279
 Grid-Bias Modulation 358
 Grid-Controlled Rectifiers 288
 Grid-Modulated Amplifier 248
 Grid Detection 48
 Grid Excitation 270
 Grid-Leak Bias 279
 Grid Neutralization 268
 Grid Modulation 356-359
 Grid Saturation 283
 Grounds 66, 67, 69
 Ground Waves 60, 67

H

Half-Wave Radiators 65
 Half-Wave Rectification 439

Half-Wave Rectifiers 41, 439
 Harmonic Content 44, 48
 Harmonic Distortion 48
 Harmonic Elimination 293
 Harmonic Frequency Determination 415
 Harmonic Generation 48
 Harmonic Interference 271
 Harmonic Operation of Antennas 88
 Harmonic Oscillator 301
 Harmonic Suppression 94
 Hartley Oscillator 284, 485
 Hawkins Modulation 357
 Hazeltine Neutralization 268
 Heating Pads, Diathermy 488
 Heaviside Layer 61, 409
 Heising Modulation 250, 356
 Henry, the 18, 19
 Heptode Tube 50
 Hertz Antenna 65
 HF-Cut Crystal 293
 High-Gain Preselector 210
 High-Gain Speech Amplifiers 350, 351, 364, 369-371, 398, 401, 405
 High-Frequency Crystals 294
 High-Vacuum Rectifier 443
 Hints, Construction 132
 Holders, Crystal 294
 Horizontal Directivity 108
 Hum 368
 Hysteresis 452

I

I. F. Amplifier 204
 I. F. Amplifier Alignment 166
 Image Interference 152, 167
 Image Ratio 167
 Impedance:
 Antenna 78
 Coupling 45
 Definition 26
 Formulas 32
 Load 44
 Matching 35
 Reflected 35, 39
 of Series Resonant Circuits 32
 Tank Circuit 33
 Tube Plate Circuit 37
 Transmission Line 74, 77, 84, 89
 Indicators, Tuning 158
 Induced Voltage 19
 Inductance:
 Calculation 19
 Definition 18
 Mutual 19
 Parallel Connection 19
 Self 18
 Series Connection 19
 Tapped 278
 Unit 18
 Inductive Coupling 37, 91, 150, 281
 Inductive Reactance 20, 151
 Injection Grid 51
 Input Impedance 154
 Input Voltages 58
 Instantaneous Power Output 344
 Instruments 460
 Insulation, Antenna 128
 Insulation, Transformer 456
 Insulators 7
 Interelectrode Capacitances 48
 Interference Elimination 292
 Internal Noise 154
 Interference, Key-Click 286
 Interference, Man-Made 161, 162
 Interruption Frequency 412
 Interstage Coupling 45

Inverse Feedback 233, 363, 364, 365
 Inverse Peak Voltage 442
 Inverted-L Antenna 71
 Ionization 42

J

Ionosphere 60
 Johnson-Q Antenna 84
 Joules 20

K

"K" 22
 Key, Automatic 146
 Key, Semi-Automatic 148
 Key Clicks 286
 Keying:
 Blocked-Grid 288
 Center-Tap 290
 Click Filters 290
 Excitation 286
 Grid 288
 Lag 286
 Manipulation of hand key 146
 Tube 290
 Oscillator 288
 Primary 286
 Keying Interference Elimination 286
 Kilocycle 16
 Kozanowski Oscillator 416

L

Lag, Keying 286
 Law, Ohm's 8, 9
 Laws, U. S. Radio 491
 Layouts 132
 L-C Circuits 271
 L-C Ratio 34, 204, 271
 LD2-Cut Crystals 293
 Lecher Wires 413
 Learning the Code 142
 Les-Tet Oscillator 231
 Level Control 477
 License, Experimental 571
 License Requirements 142, 491
 Linear Amplifier 46
 Linear Transformers 85
 Lines of Force 17
 Link Coupling 38, 282
 Load Impedance 345, 440
 Load Resistance 44
 Logarithms 52
 Long-Wire Radiators 100
 Loops, Coupling 292
 Losses, Core 451
 Losses, Eddy Current 19, 20, 451
 Losses, Feeder 76
 Losses, Hysteresis 452
 Low-Pass Filter 441
 Low Power-Factor Line Oscillator 431

M

Magnetic Flux 17
 Magnetic Line of Force 17
 Magnetomotive Force 17
 Mantissa 52
 Map of the World, W. A. Z. 510
 Marconi Antenna 62, 69, 71
 Matching Stubs 80
 Mechanical Bandspreads 152
 Megacycle 16
 Megohm 8

Memorizing Code 142
 Mercury Vapor Rectifier 41, 443
 Metal Chassis 130
 Meter as Tuning Indicator 158
 Mho 20
 Microfarad 21
 Microhenry 18, 19
 Micromicrofarad 21
 Micromho 20
 Microphone Levels 58
 Microphones:
 Carbon 346
 Condenser 347
 Crystal 347
 Double-Button 347
 Dynamic 349
 Single-Button 346
 Velocity (Ribbon) 348
 Microwave Equipment 415, 417
 Microwave Measurements 413
 Microwaves 409
 Millihenry 18
 Mixer Stage 155
 Mobile U.H.F. Antennas 123
 Modulation:
 Amplitude 345
 Checker 479
 Checking 479
 Circuits 350-365, 370, 371
 Class-A 356
 Class-AB 350
 Class-B 46, 352, 355, 370, 371
 Cross 292
 Efficiency 357
 Frequency 346
 Grid 358, 359, 376
 Heising 356
 Methods 344
 Percentage 345, 346
 Screen-Grid 360
 Series 356
 Suppressor-Grid 362
 Plate 352
 Plate and Screen 360
 Modulation Transformer Calculations 355
 Modulated Oscillator:
 Test 476
 Transmitter 410, 420
 Modulator Block Diagrams 323
 Modulators 352
 Monitors 464, 468
 Movement, Electronic 8
 Mu (Amplification Factor) 43
 Multiple-Stacked Broadside Arrays 109
 Multipliers, Frequency 266
 Multi-Tube Exciters 302
 Mutual Conductance 20, 42
 Mutual Inductance 19

N

Negative Resistance 154
 Neon Bulb Oscillators 145
 Neutralization:
 Circuits 268
 Doubler 267
 Grid 268
 Hazeltine 268
 Plate 268
 Problems 270
 Procedure 269, 270
 Neutralized Buffer 266
 Noise, Internal 154
 Noise-Balancing Systems 161
 Noise-Limiting Circuits 162
 Noise Silencers 162
 Noise Suppression 161

588
RADIO
Handbook

Non-Directional Microphone	349
Non-Resonant Line	77
North Pole	26
Nuclear Charge	7
Null Indicator	269

O

Ohm	8
Ohm's Law:	
A.C.	17
D.C.	9
Ohmmeter	471, 472
One-to-Ten-Meter Superregenerative Receiver	417
Open-End Stub Tuning	83
Open Lines	75
Orbital Electrons	7
Optical Axis	293
Orientation of Beam Antennas	117
Oscillation:	47
Parasitic	277
Triode	47
Piezoelectric	293
Twin Peak	294
Oscillator-Detector Relationship	204
Oscillator-Doubler Circuits	297
Oscillators:	
Beat Frequency	158
Code Practice	144
Concentric-Pipe	432
Electron Orbit	415
Crystal	293, 300
Electron-Coupled	284
Harmonic	301
Keying	288
Low Power-Factor Line	431
Magnetron	415
Parallel Rod	417, 427, 430
Regenerative	299, 300, 416
Self-Excited	284
Spiral Rod	428
Test	476
Oscilloscopes	478
Oscilloscopic Patterns	481
Overmodulation:	
Indicator	469, 479
Nature	469
Oxide-Coated Cathode	40

P

Padder Condenser	153
Parallel Circuits	285
Parallel Condensers	23
Parallel Feed	285
Parallel Resistors	10
Parallel Rod Amplifier	431
Parallel Rod Oscillators	240, 245, 417, 427, 430
Parallel Resonance	33
Parallel Inductors	19
Parallel Resonance	33
Parallel-Rod Oscillator	417
Parallel Tube Circuits	278, 285
Parasitics	277
Parasitic Suppressors	278
Patterns, Oscilloscopic	481
Peak Compressing Speech Amplifier	398
Peak Current	354
Peak Limiters	163, 164, 167
Peak Power	354
Pentagrid Converter	50
Pentodes	49
Pentode Crystal Oscillator	297
Percentage Modulation	344, 345

Percentage Modulation Checker	479
Permeability	17
Phase	29
Phase Angle	30
Phase Shift	345
Phone Test Set	469
Phone Transmitters (See Transmitters, Phone)	
Pierce Crystal Oscillator	298
Piezoelectric Effect	293
Plaque Resistors	103
Plate	40
Plate Circuit Tuning	271
Plate Current	40
Plate Detection	49
Plate Dissipation	45
Plate Modulation	352
Plate and Screen Modulation	360
Plate Neutralization	268
Plate Resistance	43
Plate Spacing	275
Point of Saturation	17
Polarity	7
Polarization	97-99
Polarized Condenser	24
Polarizing Voltage	247
Positive and Negative	8
Potential Difference	9
Potential Energy	- 21
Powdered Iron Core	20
Power, Apparent	30
Power, Actual	31
Power, Audio	353
Power, Average	344, 354
Instantaneous	344
Power Amplifiers:	
A.F.	44
R.F.	46 (See also—Transmitters: CW, Final Amplifiers)
Power Factor	30
Power Input Control	448
Power Levels	53
Power Measurements	11
Power Output	344
Power, Peak	354
Power Relation in Speech Waveforms	353
Power Supplies 367, 387, 389, 439, 445, 446, 447	447
Power to Decibels	53
Preamplifiers	59, 347, 348
Preselector	210
Primary Keying	286
Primary Winding	20
Proton	7
Pulsating D. C.	29, 41
Punching Chassis	134
Push-Pull Amplifier	58, 231, 276, 401
Push-Pull Crystal Oscillators	297
Push-Pull R. F. Circuits	269
Push-Pull Tube Circuits	285
Push-Push Doubler	233, 267
Push-Push Exciter	311
Push-to-Talk Relays	450

Q

"Q"	33, 150, 277
Effect of Distributed Capacity upon	151
Influence of Wire Diameter and Spacing upon	151
Q Bars	84, 85
Q Bar Spacing	86
Q Signals	522
Quasi-optical paths	409
Quartz Crystals	293
Quench	412
Quench Frequency	412
Quench Oscillator	412

R

Rack-Panel Formula 139
 Radians 28
 Radiation 62
 Radiation, Angle of 61
 Radiation, Antenna 61
 Radiation, Receiver 412
 Radiation Patterns 98, 102, 104-107
 Radiation Resistance 63, 65
 Radio Districts 500
 Radio Receiver Construction 171
 Radio Receiver Theory 149
 Radio-Frequency Amplifiers:
 Class-B 46
 Class-BC 357
 Class-C 46
 Radio-Frequency Choke 283
 Radio-Frequency Coupling 149, 150
 Radio-Frequency Resistance 151
 Radiophone Construction 372
 Radiophone-CW Block Diagrams 325
 Radiophone Block Diagrams 323
 Radiophone Power Supplies 367
 Radiophone Theory 344
 Radiophone Transmitters (See Transmitters, Phone)
 Radiotelegraph Code 143
 Radiotelegraph Transmitters (See—Transmit-
 ters, CW)
 Radio Therapy (See Diathermy)
 Radio Waves 60
 Radio Waves, Velocity of 60, 62
 Ratio, Primary to Secondary 39
 Ratio, Signal to Image 167
 Ratio, Signal to Noise 154
 Reactance:
 Capacitive 151
 Inductive 20, 151
 Receiver:
 Adjustment 165, 169
 Alignment 212
 Construction 171
 Fidelity 149
 Selectivity 149
 Theory 149
 Tuning 149
 Tubes 155, 213, 214, 230
 Receivers:
 Continuous-Coverage T. R. F. 177
 De Luxe Communications 188
 Dual Triode 171
 Five-Meter Super Gainer 201
 Five-Ten-Meter Superheterodyne 204
 High-Gain Preselector 210
 Regenerative Gainer 174
 Resistance-Coupled 5-Meter
 Superheterodyne 209
 Super Gainer 180
 Superselective Phone 192
 Supersensitive 10-20-Meter Phone 197
 Ultra Gainer 184
 U. H. F. Receiver 201, 411, 417, 429, 437
 R-C Filters 368
 R-C-Coupled Superheterodyne 209
 Reactance (See Inductive or Capacitive Reactance)
 Rectifier:
 Single-Phase Half-tone 445
 Reactance and Resistance in Combination 26
 Rectifier, High-Vacuum 443
 Rectifier, Mercury Vapor 443
 Rectification 41
 Rectification Efficiency 48
 Rectified A. C. 29, 41
 Rectifier-Filter System 41
 Rectifier, Grid-Controlled 262, 288
 Rectifier Tubes 262, 446
 Rectifier, Three-Phase, Full-Wave 446

Rectifier, Three-Phase, Half-Wave 445
 Reflected Impedance 35, 39
 Regeneration 268
 Cathode 268
 Methods 153
 Regenerative Crystal Oscillator 234, 300, 301
 Regenerative Detector 153
 Regenerative Doubler 234, 241, 266, 268
 Regenerative Exciter 298
 Regenerative R. F. Amplifier 154
 Regenerative Gainer Receiver 174
 Regenerative Oscillators 230, 299, 415
 Regulation, Power Supply 46
 Regulations, U. S. Amateur 491
 Reinartz Oscillator 301
 Rejection 34
 Relay-Rack Construction 138
 Reluctance 17
 Resistance:
 Bleeder 12, 444
 Coupling 372
 Equations 9, 10, 11, 13, 15, 16, 151
 Molecular Theory of 8
 Negative 154
 Parallel 10
 Plate 43
 Radiation 63, 65
 Radio-Frequency 151
 Series 10
 Series-Parallel 11
 Voltage Dividing 11, 13
 Resistors for Series Filament Operation 14
 Resistors, Light Bulb 548
 Resistors, Plaque 103
 Resonance:
 Formula 25
 Harmonic 63
 Parallel 33
 Resonant Circuits 30, 32, 150
 Resonant Filter 441
 Resonant Line 72
 Resonator, Crystal 293
 R. F. Amplifier:
 Parasitics in 277
 Regenerative 154
 R. F. Chokes 279, 283, 284
 R. F. Coupling Systems 280
 R. F. Inverse Feedback 365
 Rhombic Antenna 103
 Ribbon Microphone 348
 Ripple 440
 Ripple Voltage 442
 Rochelle Salt Crystals 160, 347
 Rotatable Antennas 117
 Rotating Antenna Heads 121
 R.M.S. 29, 442

S

Saturation, Core 17, 452
 Saturation, Electronic 41
 Saturation, Grid 283
 Saturation, Plate Current 41
 Screen, Faraday 93, 125, 207
 Screen Grid 48, 264
 Screen-Grid Modulation 360
 Screen-Grid Tube 48
 Secondary Emission 49
 Secondary Winding 20
 Selectivity 32, 149
 Selectivity Curve 32
 Self Bias (See Cathode Bias)
 Self-Excited Oscillator 284
 Self Inductance 18
 Self-Tuned Exciter 209

**590
RADIO
Handbook**

Sending 146
Sensitivity 149
Separate Bias Supply 280, 447
Series Circuits 10, 14, 25, 31, 32, 33
Series Condensers 24
Series Feed 285
Series Filament Operation 14
Series Inductances 19
Series-Parallel Condensers 24
Series Modulation 356
Series Resistance 9, 10
Series Resonant Circuits 32
Series-Resonant Filter 441
Series Parallel Resistance 11
Series Resonance 31, 32
Shadow Effect 409
Shorted Stub Tuning 83
Shunt Feed 285
Shunt Resistance 10
Shielding 368
Sidebands 344
Signal Generator 476
Signal-Image Ratio 167
Signal-Noise Ratio 154
Silencers, Noise 162
Sine Wave 27
Single-Dial Control 153, 304
Single-Phase Half-Wave Rectifier 445
Single-Signal Effect 159, 160
Single-Tube Exciters 296
Single-Wire-Fed Antenna 78
Skin Effect 151
Skip Distance 60, 61
Sky Wave 61
Smoothing Choke 443, 457
Socket Connections 227, 228
Socket Holes, Punching 134
Soldering 136
Sound Waves 346
South Pole 26
Space Charge Effect 40
Speech Amplifiers 346, 349, 350, 351, 364, 369-371, 398, 401, 405
Speech Intelligibility 344
Speech Waveforms 353
Spiral-Rod Oscillator 428
Spray-Shield Tubes 294
Stacked Dipole Antenna 106
Standards of Good Engineering Practice 516
Standing Waves 62
Steel Drilling 133
Sterba Array 108
Stress, Dielectric 21
Stubs, Matching 80
Super Gainer 180
Superheterodyne Receivers (See—Receivers)
Superheterodyne Alignment 165
Superheterodyne Theory 155, 165
Superregeneration 155, 411
Superselective Phone Receiver 192
Supersensitive 10-20-M. Phone Receiver 199
Suppressor Grid 49
Suppressor-Grid Modulation 362
Suppression, Bass 354
Surge Impedance 86
Sweep Circuits 480
Swinging Choke 443, 457
Symbols, Radio 530, 540

T

Tables (See—Charts)
Tank Circuits 271
Tank Circuit Flywheel Effect 35
Tank Current 34
Tapped Inductances 278
Test Equipment 460
Test Oscillator 476

Tetrodes 48
Thermal Noise 412
Thermogalvanometer, Use in Neutralizing 269
Three-Phase Half-Wave Rectifier 445
Tickler Coil 153
Tools 130-132
Tourmaline Crystals 293
Tracking 212
Transceivers 293, 419, 433, 435
Transconductance 20, 43
Transconductance, Conversion 51
Transfilter 160
Transformer Design 451, 456
Transformer Insulation 456
Transformers 19, 20, 134, 454, 455, 456
Transmission Lines 71
Transmitter Power Input Control 448
Transmitter Theory 263
Transmitters:

C. W.:

50-Watt T20 328
100-Watt T40 329
120-Watt P. P. 809 351
150-Watt 35T 333
400-Watt HK54 337
De Luxe 10-Meter 335

Final Amplifiers:

P. P. 35T 340
P. P. HK54 341
P. P. 809 342
P. P. T200 or HF300 343
P. P. HK254 343

Phone:

30-Watt 160-M. 374
50-Watt 10 to 160-M. 376
75-Watt 10 to 160-M. 380
400-Watt 10 to 160-M. 385
1-K. W. Phone 392

Trimmer Condenser

Triplers 296
Tritet Oscillator 232, 234, 298

Tubes:

Circuits 285
Receiving 155, 213, 214, 230
Rectifiers 262, 446
Theory 40
Transmitting 229
TNT Oscillator 284
TPTC Circuit 284
Tuned Circuits 150
Tuned R. F. 152, 153, 155
Tuned R. F. Alignment 165
Turns-Voltage Ratio 35
Tuned Doublet 73
Tuning 271, 303
Tuning Capacities 151
Tuning Eye 158
Tuning Indicators 158
Turns Ratio 36
Twin Peaks 294
Twin Triode 50
Twisted-Pair Feeders 75
Two-Wire Open Line 75

U

U. H. F. Antennas 121, 413
U. H. F. Communication 409
U. H. F. Converter 202
U. H. F. Operation 409
U. H. F. Receivers 201, 411, 417, 429, 437
(See also—Receivers)
U. H. F. Theory 409
U. H. F. Transmitters 410, 420-438
U. H. F. Wavemeters 414
Ultra-Gainer Receiver 184

Unidirectional Array115, 118
Unity Coupling39
Universal Antenna Coupler95

V

"V" Antenna101
Vacuum Tube:
 Amplifier42
 Detector48
 Oscillator47
 Rectifier41
Vacuum Tube:
 Receiving155, 213, 214, 230
 Rectifiers262
 Special Types50
 Transmitting229
Vacuum-Tube Keying290
Vacuum Tube Theory40
Vacuum-Type Condenser277
Variable-Gap Crystal Holder294
V-Cut Crystal293
Vector Sum18
Velocity Microphone348
Vertical Antennae67
Vertical Directivity60, 115
Volt, the8
Volt-Ampere-Watt Conversion Table12
Voltage, Across Coil and Condenser33
Voltage Amplification44
Voltage Amplifier 44, 56 (See—Speech Amplifier)
Voltage, Cutoff266
Voltage Dividers11, 13
Voltage Drop9
Voltage Feed71
Voltage, Induced19
Voltage Loops62
Voltage Nodes62
Voltage Multiplier471
Voltage Rating of Series Condensers24
Voltage Regulation46, 368
Voltage, Ripple442
Voltage-Turns Ratio35
Voltage, Working22
Voltohmmeter471
Voltmeter471

Voltmeter, Vacuum-Tube473, 474, 475
Volume Compressor (Automatic Peak
 Limiters)367
Volume Control292
 Automatic156, 157
V. T. Voltmeter473-475

W

Watt, the11
Waveform:
 Class-A42
 Class-B46
 Class-C47, 272
 Speech353
Waveform Distortion43, 271
Wavelength62
Wavelength Determination413
Wavemeters461
Wavemeters, U. H. F.414
Waves, Standing62
Wave Traps292
W.A.Z. Map of the World510
Wide Band Crystal Filter160
Wire Tables454, 455
Workshop Kinks137
Workshop Practice129
Working Voltage22

X

X Axis293
X-Cut Crystals293, 294

Y

Yagi, Data115
Y Axis293
Y-Cut Crystals294

Z

Y-Matched Impedance Antenna80
Z Axis293
Zero Beat166
Zepp Antenna72
Zinc Alloy Drilling133



Index to Advertisers

The following advertisers are commended to our readers. Their products and services are nationally known and respected. Similar books in other technical fields sell for \$5.00 upwards, mostly upwards. Whatever value this book may have for you above its purchase price is a gift to you from these advertisers who have made such a policy possible; we suggest that you patronize them when purchasing parts for items described in this book.

American Microphone Company, Inc.	567	Leeds	568
Amperex Electronic Products, Inc.	537	Lenz Electric Manufacturing Co.	553
Amperite Co.	573	Mallory & Co., Inc., P. R.	517
Astatic Microphone Laboratory, Inc.	507	Meissner Manufacturing Co.	571
Barker & Williamson	559	Ohmite Manufacturing Co.	532, 533
Birnbach Radio Co., Inc.	547	Par-Metal Products Corp.	565
Bliley Electric Co.	519	RCA Manufacturing Co., Inc.	514, 515
Browning Laboratories, Inc.	569	Radio Manufacturing Engineers, Inc.	526, 527
Bud Radio, Inc.	541	Radio, Ltd.	
Capitol Radio Engineering Institute	573	"RADIO Antenna Handbook"	505
Cardwell Manufacturing Corp., The		Radio Binder	575
Allen D.	535	"RADIO Digest"	555, 569
Centralab	503	"RADIO Handbook" (Spanish Edition)	501
Chicago Radio Apparatus Co.	508	Radio Library	499
Cornell-Dubilier Electric Corporation	560, 561	"RADIO Noise Reduction Handbook"	504
Crowe Name Plate & Manufacturing Co.	509	"RADIO"	550, 551
Decker Mfg. Co.	563	"RADIO Telephony Handbook"	554
Eitel-McCullough, Inc.	513	W. A. Z. Maps	576
Guardian Electric Mfg. Co.	567	"Radio News"	557
Hallicrafters, Inc., The	520, 521	Radio Supply Company	562, 574
Hammarlund Mfg. Co., Inc.	523	Radio-Television Supply Company	558
Harvey Radio Company	564	Simpson Electric Co.	559
Heintz & Kaufman, Ltd.	529	Solar Manufacturing Corp.	531
Herbach & Rademan, Inc.	572	Standard Transformer Corporation	525
Instructograph Co., The	545	Sun Radio Co.	566
Jones, Howard B.	497	United Catalog Publishers	556
Leach Relay Co.	549	United Transformer Corporation	539
		Wholesale Radio Service Co., Inc.	543

ANOTHER PUBLICATION
BY THE
EDITORS OF
RADIO